



MESSIAH COLLEGE

SCHOOL OF THE ARTS

COLLEGE AVENUE, MECHANICSBURG, PENNSYLVANIA
17055 UPPER ALLEN TOWNSHIP, CUMBERLAND COUNTY

Revised March 2017

PROJECT MANUAL

TECHNICAL SPECIFICATIONS TABLE OF CONTENTS

Section 020000	Administrative
Section 020010	Background Checks Page 1
Section 020020	Pre-bid Meeting Pages 1 – 2
Section 020100	Insurance Requirements.....Page 1
Section 020200	Protection of Persons and Property.....Pages 1-2
Section 020210	Miscellaneous Provisions.....Pages 1-3
Section 020300	Code Required Special Inspections and Procedures.....Pages 1-3
Section 040000	General
Section 040010	Cutting and Patching..... Pages 1 – 4
Section 040020	Construction Waste and Disposal Pages 1 – 2
Section 060000	Temporary During Construction
Section 060010	Temporary Facilities and Controls..... Pages 1 – 10
Section 060020	Temporary Tree and Plant Protection Pages 1 – 7
Section 080000	Roof
Section 080010	Ethylene Propylene Diene Monomer (EPDM) Roofing Pages 1 – 11
Section 080020	Roof Specialties Pages 1 – 9
Section 080030	Roof Accessories..... Pages 1 – 9
Section 100000	Doors
Section 100010	Hollow Metal Doors and Frames Pages 1 – 10
Section 100020	Doors and Frames Pages 1 – 9
Section 100030	Doors and Frames (2)..... Pages 1 – 49
Section 100040	Access Doors and Frames Pages 1 – 4
Section 100050	Door Window Light Kits Page 1
Section 100060	Sectional Doors Pages 1 – 5
Section 100070	Aluminum Framed Entrances and Storefronts..... Pages 1 – 14
Section 100080	Fire Rated Entrances and Storefronts..... Pages 1 – 11
Section 101000	Door Hardware..... Pages 1 – 14

PROJECT MANUAL

TECHNICAL SPECIFICATIONS TABLE OF CONTENTS

Section 120000	Plumbing	
Section 120010	General Provisions- Plumbing	Pages 1 – 13
Section 120020	Plumbing Basic Materials	Pages 1 – 6
Section 120030	Plumbing Pipe and Pipe Fittings.....	Pages 1 – 8
Section 120040	Plumbing Piping Specialties	Pages 1 – 4
Section 120050	Plumbing Specialties.....	Pages 1 – 4
Section 120060	Plumbing Valves.....	Pages 1 – 4
Section 120070	Plumbing Supports and Anchors	Pages 1 – 4
Section 120080	Plumbing Insulation	Pages 1 – 4
Section 120110	Plumbing Pumps.....	Pages 1 – 2
Section 120120	Sanitary Drainage.....	Pages 1 – 5
Section 120130	Interceptors.....	Pages 1 – 2
Section 120140	Storm Drainage	Pages 1 – 3
Section 120150	Water Conditioning System.....	Pages 1 – 2
Section 120160	Water Heater	Pages 1 – 2
Section 120170	Plumbing Fixtures.....	Pages 1 – 8
Section 120180	Special Piping Systems	Pages 1 – 4
Section 120190	Fuel Gas Piping and Specialties.....	Pages 1 – 2
Section 120200	Wiring of Plumbing Equipment.....	Pages 1 - 2
Section 120210	Emergency Shower and Eye Wash	Pages 1 - 4
Section 120220	Plumbing Specs.....	Pages 1 – 14
Section 120230	Plumbing Specs (2).....	Pages 1 – 8
Section 120240	Disinfection of Water Lines.....	Pages 1 - 3
Section 120250	Pipe Leak Testing.....	Pages 1 – 8
Section 120260	Exterior Hose Bib	Pages 1 – 6
Section 140000	Water Treatment	
Section 140010	Chemical Water Treatment.....	Pages 1 – 2
Section 160000	HVAC	
Section 160010	General Provisions - HVAC	Pages 1 - 13
Section 160020	HVAC Basic Materials	Pages 1 - 7
Section 160030	HVAC Pipe and Pipe Fittings.....	Pages 1 – 7
Section 160040	HVAC Pipe Specialties.....	Pages 1 – 8
Section 160050	HVAC Valves	Pages 1 – 5
Section 160060	HVAC Supports and Anchors.....	Pages 1 – 3
Section 160070	HVAC Sound and Vibration Control.....	Pages 1 - 5
Section 160080	HVAC Insulation	Pages 1 – 7
Section 160090	Variable Frequency Drives	Pages 1 – 4
Section 160100	HVAC Pumps	Pages 1 – 4
Section 160110	Air Distribution.....	Pages 1 – 10
Section 160120	Variable Air Volume System	Page 1

PROJECT MANUAL
TECHNICAL SPECIFICATIONS TABLE OF CONTENTS

Section 160000	HVAC (Continued)	
Section 160130	Fans and Gravity Ventilators	Pages 1 – 6
Section 160140	Dust Collection System.....	Pages 1 – 2
Section 160150	Kitchen Fume Hoods	Pages 1 – 6
Section 160160	Air Filtration	Pages 1 – 2
Section 160170	Heat Transfer	Page 1 – 4
Section 160180	Central Station Air Handling Units.....	Pages 1 – 9
Section 160190	Unitary Equipment.....	Pages 1 – 3
Section 160200	Terminal Heating Units.....	Pages 1 – 3
Section 160210	Building Automation System.....	Pages 1 – 12
Section 160220	Testing Adjusting and Balancing of HVAC System.....	Pages 1 – 5
Section 160230	Wiring of HVAC Equipment	Pages 1 – 4
Section 160240	Closed Loop New Construction With Tie in to Existing.....	Page 1 – 11
Section 180000	Electrical	
Section 180010	General Provisions - Electrical	Pages 1 – 14
Section 180020	Electrical Basic Materials	Pages 1 – 9
Section 180030	Wire and Cable 600 Volts and Below.....	Pages 1 – 8
Section 180040	Raceway and Fittings	Pages 1 – 11
Section 180050	Boxes.....	Pages 1 – 5
Section 180060	Wiring Devices	Pages 1 – 7
Section 180070	Grounding Systems	Pages 1 – 4
Section 180080	Electrical Service	Pages 1 – 3
Section 180090	Air Hand Dryers.....	Page 1
Section 180100	Panelboards	Pages 1 – 3
Section 180110	Disconnect Switches	Pages 1 – 2
Section 180120	Overcurrent Protective Devices	Pages 1 – 4
Section 180130	Dry Type Transformers.....	Pages 1 – 3
Section 180140	Lighting Protection	Pages 1 – 3
Section 180150	Lighting.....	Pages 1 – 5
Section 180160	Exterior Lighting.....	Page 1 - 42
Section 180170	Lighting Controls	Pages 1 – 12
Section 180180	Special Systems.....	Pages 1 – 2
Section 180190	Controls and Instrumentation.....	Pages 1 – 4
Section 180200	Wiring of Mechanical Equipment.....	Pages 1 – 5
Section 180210	Electrical Specs	Pages 1 – 23
Section 200000	Fire Alarm	
Section 22000	Telecom/Network	
Section 220010	Messiah Telecom-Network Standards	Pages 1 – 6

PROJECT MANUAL

TECHNICAL SPECIFICATIONS TABLE OF CONTENTS

Section 240000	General Construction	
Section 240010	Maintenance of Cast-in-Place Concrete.....	Pages 1 – 13
Section 240020	Cast-in-Place Concrete.....	Pages 1 – 47
Section 240030	Unit Masonry	Pages 1 – 23
Section 240040	Cast Stone Masonry	Pages 1 – 9
Section 240050	Bentonite Waterproofing.....	Pages 1 – 6
Section 240060	Thermal Insulation	Pages 1 – 5
Section 240070	Thermal Testing	Page 1
Section 240080	Insulated Metal Wall Panels	Pages 1 – 10
Section 241010	Glazing.....	Pages 1 – 8
Section 241020	Fixed Louvers	Pages 1 – 7
Section 241030	Non-Structural Metal Framing.....	Pages 1 – 5
Section 241040	Gypsum Board	Pages 1 – 6
Section 241050	Intumescent Fireproofing.....	Pages 1 – 6
Section 241060	Penetration Fireproofing	Pages 1 – 8
Section 241070	Preformed Joint Seals	Pages 1 – 5
Section 241080	Joint Sealants	Pages 1 – 10
Section 242010	Resilient Base and Accessories.....	Pages 1 – 5
Section 242010	Resinous Flooring	Pages 1 – 6
Section 242030	Tile Carpet	Pages 1 – 7
Section 243010	Acoustical Panel Ceilings	Pages 1 – 9
Section 244010	Exterior Painting	Pages 1 – 6
Section 244020	Interior Painting	Pages 1 – 9
Section 245010	Toilet and Bath Accessories.....	Pages 1 – 7
Section 245020	Fire Protection Specialties	Pages 1 – 3
Section 245030	Metal Lockers	Pages 1 – 6
Section 245040	Horizontal Louver Blinds.....	Pages 1 – 5
Section 245050	Window Shades	Pages 1 – 7
Section 245060	Plastic Laminate-Clad Countertops	Pages 1 – 7
Section 245070	Simulated Stone Countertops.....	Pages 1 – 3
Section 245080	Residence Hall Windows.....	Page 1
Section 26000	Signage	
Section 260010	Exterior Building ID Signage.....	Page 1
Section 280000	Site Construction	
Section 280010	Site Clearing and Construction Layout	Pages 1 – 8
Section 280020	Earthwork.....	Pages 1 – 22
Section 280030	Erosion and Sedimentation Control	Pages 1 – 3
Section 280040	Excavation Support and Protection.....	Pages 1 – 5
Section 281010	Hot-Mix Asphalt Paving.....	Pages 1 – 6
Section 282010	Cement Concrete Pavement.....	Pages 1 – 12

PROJECT MANUAL
TECHNICAL SPECIFICATIONS TABLE OF CONTENTS

Section 280000	Site Construction (Continued)	
Section 284010	Seeded Turf and Grasses.....	Pages 1 – 10
Section 285010	Exterior Plants.....	Pages 1 – 12
Section 286010	Storm Utility Drainage Piping	Pages 1 – 9
Section 286020	Sub Drainage.....	Pages 1 – 6
Section 300000	Training	
Section 300010	Demonstration and Training	Pages 1 – 4
Section 320000	Commissioning	
Section 320010	General Commissioning Requirements	Pages 1 – 3
Section 340000	Close Out	
Section 340010	Close Out Procedures.....	Pages 1 – 8
Section 340020	Operation and Maintenance Data.....	Pages 1 – 8
Section 340030	Spare Parts and Materials.....	Pages 1 – 2

END OF TABLE OF CONTENTS

SECTION 020010

PART 1 – BACKGROUND CHECKS

1.1 BACKGROUND CHECKS

- A. Contractors must comply with Messiah College’s background check policy, found on the purchasing website.

****END OF SECTION****

**SECTION 020020
PREBID MEETING**

1.1 PREBID MEETING

- A. Owner will conduct a Pre-bid meeting as indicated below:
 - 1. Meeting Date:
 - 2. Meeting Time:
 - 3. Location:

- B. Attendance:
 - 1. Prime Bidders: Attendance at Pre-bid meeting is **mandatory**.
 - 2. Subcontractors: Attendance at Pre-bid meeting is recommended.
 - 3. Notice: Bids will only be accepted from prime bidders represented on Pre-bid Meeting sign-in sheet.

- C. Bidder Questions: Submit written questions to be addressed at Pre-bid meeting minimum of **two** business days prior to meeting.

- D. Agenda: Pre-bid meeting agenda will include review of topics that may affect proper preparation and submittal of bids, including the following:
 - 1. Procurement and Contracting Requirements:
 - a. Instructions to Bidders.
 - b. Bonding.
 - c. Insurance.
 - d. Bid Form and Attachments.
 - e. Bid Submittal Requirements.
 - f. Bid Submittal Checklist.
 - g. Notice of Award.

 - 2. Communication during Bidding Period:
 - a. Obtaining documents.
 - b. Bidder's Requests for Interpretation.
 - c. Bidder's Substitution Request / Prior Approval Request.
 - d. Addenda.

 - 3. Contracting Requirements:
 - a. Agreement.
 - b. The General Conditions.
 - c. Other Owner requirements.

 - 4. Construction Documents:
 - a. Scopes of Work.

- b. Temporary Facilities.
 - c. Use of Site.
 - d. Work Restrictions.
 - e. Alternates, Allowances, and Unit Prices.
 - f. Substitutions following award.
5. Separate Contracts:
- a. Work by Owner.
 - b. Work of Other Contracts.
 - c. Contractor installation of Owner provided items.
6. Schedule:
- a. Project Schedule.
 - b. Contract Time.
 - c. Liquidated Damages.
 - d. Other Bidder Questions.
7. Site / facility visit or walkthrough.
8. Post-Meeting Addendum.
- E. Minutes: The Owner will address pre-bid meeting questions by Addendum as required. Meeting minutes may or may not be issued by the Owner. Minutes of meeting are issued as Available Information and do not constitute a modification to the Procurement and Contracting Documents. Modifications to the Procurement and Contracting Documents are issued by written Addendum only.
1. Sign-in Sheet: Minutes may include list of meeting attendees.

** END OF SECTION **

SECTION 020100
INSURANCE REQUIREMENTS-CONSTRUCTION

Liability Limits: The insurance required by Messiah College for the Ravine Stabilization Project shall be written for not less than the following limits unless the limit provided herein is less than that required by applicable law, in which case the greater limit shall apply. All limits under the General Liability coverage shall apply on a per project basis:

Workers' Compensation:

- a. State: statutory requirement
- b. Federal: statutory

Comprehensive Contractors' General Liability

- a. Bodily Injury and Property Damage:
 - \$1,000,000 per occurrence
 - \$3,000,000 aggregate
- b. Products Completed Operations:
 - \$3,000,000 aggregate
- c. Contractually Assumed Liability for Bodily Injury and Property Damage:
 - \$1,000,000 per occurrence
 - \$3,000,000 aggregate
 - Liability coverage shall be written under an occurrence policy with all limits applying on a project basis.
- d. Personal Injury:
 - \$3,000,000 aggregate

Automobile Liability:

- a. Bodily Injury:
 - \$1,000,000 per person
 - \$1,000,000 per accident
- b. Property Damage:
 - \$1,000,000 per accident

Additional Insured: The College, the Architect and their consultants shall be named as additional insureds under the policies of insurance required under the above paragraphs.

Coverage: All coverage required shall be on an "occurrence" rather than a "claims made" basis.

**SECTION 020200
PROTECTION OF PERSONS AND PROPERTY**

PART 1 - GENERAL

1.1 SAFETY PRECAUTIONS AND PROGRAMS

- A. Contractor shall notify the Owner prior to renovation operations in which more than 260 linear feet or 160 square feet regulated asbestos-containing material is stripped or removed from facility components.
- B. In lieu of any existing products known to contain hazardous materials (asbestos, lead paint, etc.) and are scheduled to be removed, should any Contractor encounter asbestos, lead paint, hazardous materials or suspect the presence of such in a material, he shall immediately stop work and notify the Owner who shall then take action for its removal.
- C. The Owner and Owner's Representative make no representation regarding the possible presence of hazardous materials, including but not limited to asbestos, polychlorinated biphenyl (PCB) and lead based paints within the area of construction. It is the Contractor's sole responsibility to implement any and all necessary test procedures and precautions against such possibility and to strictly follow and enforce all municipal, state, and federal regulations regarding any hazardous material and safe work place practices and hazardous material disposal.
- D. If the Contractor fails to give such notices, or fails to comply with such laws, ordinances, rules, regulations, and lawful orders, it shall be liable for and shall indemnify and hold harmless the Owner and their respective employees, officers, and agents, against any resulting fines, penalties, judgements, or damages, including reasonable attorney's fees, imposed on or incurred by the parties indemnified hereunder.

1.2 SAFETY OF PERSONS AND PROPERTY

- A. The Contractor shall provide and maintain in good operating condition suitable and adequate fire protection equipment and services, and shall comply with all reasonable recommendations of the fire insurance company carrying insurance on the Work or by the local fire chief or fire marshal. The area within the sire limits shall be kept orderly and clean and all combustible rubbish shall be promptly removed from the site.
- B. The Contractor shall at all times protect excavations, trenches, buildings and materials from rainwater, ground water, back up or leakage of sewers, drainage or other piping, and from water of any other origin and shall remove promptly any accumulation of water. Contractor shall provide and operate all pumps, piping and other equipment necessary to this end.
- C. The contractor shall remove snow or ice which may result in damage or delay.
- D. The Contractor shall take all precautions necessary to prevent loss or damage caused by vandalism, theft, burglary, pilferage, or unexplained disappearance of property of the Owner, whether forming part of the Work, located within those areas of the Project to which the Contractor has access. The Contractor shall have full responsibility for the security for such

property of the Owner located in such areas and shall reimburse the owner for any such loss, damage or injury, except such as may be directly caused by agents or employees of the Owner.

1.3 DEMOLITION AND RENOVATION OPERATIONS

- A. To protect persons and property, the Contractor shall take all necessary precautions during demolition and renovation operations to locate and discontinue or otherwise identify and protect existing utilities; to maintain the structural integrity of the building, and to protect the interior contents of the building during construction operations.
- B. All demolition work shall be done by qualified tradesmen from each respective trade, especially in the areas of structural, mechanical, and electrical demolition.
- C. Upon request, the Owner and the Contractor shall attend a meeting to review the facility operations and performance.

** END OF SECTION **

**SECTION 020210
MISCELLANEOUS PROVISIONS**

PART 1 - GENERAL

1.1 TESTS AND INSPECTIONS

- A. This paragraph governs testing and inspection required by the Drawings and Specifications to be performed by Contractor. Owner will arrange for an independent testing and inspection firm to perform those tests and inspections not required to be performed by Contractor or its Subcontractor.

1.2 CODE COMPLIANCE

- A. Fire Rated Assemblies: All penetrations and openings whether indicated or not through fire-rated walls, floor/ceiling or roof/ceiling assemblies which are indicated on the drawings, shall be provided and installed to maintain the fire-rated integrity of the design with dampers, tenting over lights, etc. These penetrations and openings include, but shall not be limited to, louvers, lights, mechanical and electrical penetrations, etc.
- B. Fire Rated Partitions: All fire partitions shall extend from the top of the floor assembly below to the underside of the floor/roof slab or deck above, to the fire resistance rated floor/ceiling or roof/ceiling assembly above, and shall be securely attached thereto.

1.3 WORK RESTRICTIONS

- A. On Site Work Hours: Work shall be generally performed inside the existing building during normal business hours of between 7:30 AM to 4:00 PM, Monday through Friday, except otherwise indicated.
 - 1. Weekend hours: Coordinate with Owner
 - 2. Early morning hours: Coordinate with Owner
 - 3. Hours for utility shutdowns: Coordinate with Owner
 - 4. Hours for core drilling: Coordinate with Owner
- B. Existing Utility Interruptions: Do not interrupt utilities serving facilities occupied by Owner or others unless permitted under the following conditions and then only after arranging to provide temporary utility services according to requirements indicated:
 - 1. Notify Owner not less than 3 days in advance of proposed utility interruptions.
 - 2. Do not proceed with utility interruptions without Owner's written permission.
- C. Nonsmoking Campus: Smoking is not permitted on Campus.

1.4 MISCELLANEOUS PROVISIONS

- A. Existing Utilities: The Contractor shall call 811 'One Call System' as indicated prior to performing any excavation work.

1. Locate existing underground utilities in areas of excavation work prior to beginning excavation operations. Visibly mark or stake existing utilities for the duration of construction and renovations. If utilities are indicated to remain in place, provide adequate means of support and protection during earthwork operations.
 2. Should uncharted, or incorrectly charted piping or other utilities be encountered during excavation, consult utility owner immediately for directions. Cooperate with Owner and utility companies in keeping respective services and facilities in operation. Repair damaged utilities to satisfaction of utility owner.
 3. Do not interrupt existing utilities serving facilities occupied by Owner or others, during occupied hours, except when permitted in writing by Owner and then only after acceptable temporary utility services have been provided.
 4. Provide minimum 48-hour notice to Owner and receive written notice to proceed before interrupting any utility.
- B. Compliance with Pennsylvania Acts 287 and 222: Contractors shall call 811 (One Call System) to verify the exact location of underground facilities within not less than three (3) nor more than ten (10) working days prior to beginning any excavation or demolition work as required by General Assembly of the Commonwealth of Pennsylvania Act 172 (HB 1735).
- C. Criminal History Information: Pursuant to Section 111 of the Public School Code of 1949, Act of March 10, 1959, P. L. 30, No. 14, as amended, H. B. 1139, Session of 1985, 24 P. S. #111, prospective employees of public and private schools, intermediate units and area vocational technical schools, including independent contractors and their employees, except employees and independent contractors and their employees who have no direct contact with children, are required, prior to employment, to furnish certain information, as set forth on this form.
1. The successful vendor must submit, on prescribed form, a report of criminal history information from the Pennsylvania State Police or a statement from the State Police that the State Police central repository contains no such information relation to him/her and any employee working on the school district's site. The report or statement must be no more than one year old. To obtain this document, contact the State Police Barracks nearest your home. You must submit the original of the required document if awarded the bid before commencing with the project(s).
 2. For the Prime Contractors, or any of their employees, whether residents of Pennsylvania or not, reports on the Federal Criminal History from the Federal Bureau of Investigation must be submitted. The report must be not more than one year old. To obtain such a report, contact the FBI Field Office nearest you.
 3. If the decision not to award this bid to you is based in whole or in part on your criminal history record information you will be so notified in writing.
 4. Criminal History Record Information sheets must be submitted with Performance and Payment bonds.
- D. Use of Tobacco Products: In accord with the College Policies- smoking and other use of tobacco is prohibited on Campus. Contractors and their employees working on Owner's property are similarly prohibited from smoking in Owner's buildings, or on Owner's property.
- E. Safety: Contractor is responsible for initiating, maintaining, and supervising all safety precautions and programs in connection with the Work.
1. Contractor shall take all reasonable precautions for the safety of, and shall provide all reasonable protection to prevent damage, injury, or loss to all employees on the Work and all other persons who may be affected thereby.

2. Contractor shall give all notices and comply with all applicable laws, ordinances, rules, regulations, codes of standards bearing on the safety of persons or their protection from damage, injury or loss, including without limitation, compliance with the requirements of the Occupational Safety and Health Act (OSHA) as amended from time to time. Nothing in this agreement or any other company directive or document relieves the Contractor from fully understanding and complying with the foregoing. Contractor shall develop and implement a safety program responsive to the standards of OSHA, communicate such safety program to its employees, and Contractor will strictly enforce the safety rules under such safety program.
 3. Barricades and Guard Lights: Provide and maintain barricades, railings, and guard lights at obstructions, trenches, excavations, newly laid concrete, etc., wherever necessary to safeguard public and in accordance with applicable codes and ordinances.
- F. Americans with Disabilities Act (ADA): Whether indicated or not, the Contractor must comply with Americans with Disabilities Act Guidelines (ADAG) and ANSI 117.1-1986, including but not limited to mounting heights of all equipment, fixtures, accessories, clearances, hardware, railings, signage, slip resistance of floors and ramps, etc.
- G. Protection Requirements:
1. Bracing, Shoring, and Sheeting: Provide shoring, bracing, and sheeting required to safely execute work under contract and remove it after it has served its purpose.
 2. Loss by Theft or other Causes: Contractor shall protect against loss of material, work, or equipment by theft, vandalism or other causes and take such precautions as he sees fit to protect himself against loss therefrom. To safeguard building and contents, stored materials, and equipment may necessitate watchman's service and Contractor shall bear the cost for such service.
 3. Weather Protection: Provide adequate protection of work and materials against damage by elements, rain, snow, wind, storms, frost, or heat. At end of day's work, protect new work liable to damage with temporary covering.
 4. Fire Protection: Take reasonable precaution to guard against damage by fire and provide suitable fire protection equipment as deemed necessary. Do not build fire on premises.
 5. Site Protection: Protect roads, curbs, sidewalks, and landscape work from damage, providing guards and covering, whether on site, on adjacent properties, or on public streets. Repair or replace damaged work at Contractor's expense.
 6. Adjoining Property: Take adequate precautions and provide safeguards to protect adjoining property, buildings, fences, etc., against damage from blasting, excavating, moving equipment or other operations under this control.

** END OF SECTION **

SECTION 020300
CODE REQUIRED SPECIAL INSPECTIONS AND PROCEDURES

PART 1 - GENERAL

1.1 SUMMARY

- A. Section includes:
1. Requirements for a program to provide code-related special inspections that will be performed by an independent code-required Approved Agency employed by the Owner, or the Registered Design Professional acting as agent of the Owner.
 2. Requirements for removing and replacing Work not conforming to the requirements of the Contract Documents.

1.2 REFERENCES

- A. American Concrete Institute (ACI):
1. ACI 318/318R, Building Code Requirements for Structural Concrete and Commentary.
 2. ACI 530/530R, Building Code Requirements for Masonry Structures and related Commentary (ACI 530/ASCE 5/TMS 402).
 3. ACI 530.1/530.1R, Specifications for Masonry Structures and Related Commentary (ACI 530.1/ASCE 6/TMS 602).
- B. American Institute of Steel Construction (AISC):
1. AISC 360, Specification for Structural Steel Buildings.
- C. ASTM International (ASTM):
1. ASTM A6/A6M, Standard Specifications for General Requirements for Rolled Structural Steel Bars, Plates, Shapes, and Steel Piling.
 2. ASTM A568/A568M, Standard Specifications for Steel, Sheet, Carbon, Structural, and High-Strength, Low-Alloy, Hot Rolled and Cold Rolled, General Requirements.
 3. ASTM A706/A706M, Standard Specification for Low-Alloy Steel Deformed and Plain Bars for Concrete Reinforcement.
 4. ASTM C31/C31M, Standard Practice for Making and Curing Concrete Test Specimens in the Field.
 5. ASTM C172, Standard Practice for Sampling Freshly Mixed Concrete.
- D. American Welding Society (AWS):
1. AWS D1.1/D1.1M, Structural Welding Code - Steel.
 2. AWS S3, Structural Welding Code – Sheet Steel.
 3. AWS D1.4/D1.4M, Structural Welding Code – Reinforcing Steel.
- E. International Code Council (ICC):
1. ICC International Building Code (IBC) 2009.

1.3 DEFINITIONS

- A. Special Inspection: Observation, inspection, or testing performed by the independent code-required Approved Agency of the materials, installation, fabrication, erection, or placement of components and connections that require special expertise to ensure compliance with the approved construction documents and reference standards.
- B. Special Inspection, Continuous: The full-time observation of work requiring special inspections by an approved special inspector who is present in the area where the work is being performed.
- C. Special Inspection, Periodic: The part-time or intermittent observation of work requiring special inspection by an approved special inspector who is present in the area where the work has been or is being performed and at the completion of the work.
- D. Structural Observation: The visual observation of the structural system by a Registered Design Professional for general conformance to the approved construction documents.
- E. Statement of Special Inspections: A document prepared by the Registered Design Professional indicating that special inspection and/or testing required by the building official, or by the Registered Design Professional responsible for each portion of the Work, is required for the Work of this Contract, and describing in some detail the type and extent of each inspection and test required, including whether or not each will be carried out continuously or periodically.

1.4 QUALITY ASSURANCE

- A. Regulatory Requirements:
 - 1. Code-Required Approved Agency:
 - a. The Owner, or the Registered Design Professional acting as Owner's agent, will employ an independent testing and inspection agency to perform the special inspections required by the ICC International Building Code (IBC).
 - b. For the purpose of this contract, the code-required independent testing and inspection agency will be indicated by the term 'Approved Agency'.
 - c. The qualifications for the Approved Agency performing the code-required special inspections and testing are specified in Quality Requirements.
 - d. The Approved Agency must be independent of the contractor.
 - 2. Code Compliance:
 - a. Materials and fabrication procedures provided under this Contract are subject to the requirements of the ICC International Building Code (IBC), must comply with all federal, state, and local codes and ordinances and are subject to special inspections, sampling, and testing in the mill, the shop, and the field in order to verify compliance with IBC.

1.5 PROJECT CONDITIONS

- A. For the duration of this Contract and as required by the General Conditions, provide the Owner, the Registered Design Professional, the independent code-required Approved Agency, and the governmental agencies that have jurisdictional interests, assess to the Site and Work at reasonable times for their observation, inspection, and testing.

- B. Give the Approved Agency timely notice of the readiness of the Work for the required inspections, tests, or approvals, as specified in the applicable specification but in no case less than 3 days notice. Cooperate with inspection and testing personnel to facilitate the required inspections and tests.
- C. Uncover existing Work whenever necessary to allow the Work to be inspected or tested by the Approved Agency and other inspection and testing personnel.

PART 2 - PRODUCTS

2.1 SOURCE QUALITY CONTROL

- A. Tests:
 - 1. Materials and fabrication procedures provided under this Contract are subject to testing in the mill and the shop in order to verify compliance with the requirements of the ICC International Building Code (IBC).
 - 2. Each manufacturer of designated seismic system components must test or analyze the component and its mounting system or anchorage, and submit a certificate of compliance for review and acceptance by the Registered Design Professional and for approval by the building official.
- B. Inspection:
 - 1. Special inspections of the fabrication of structural load-bearing members and assemblies in a fabricator's shop are required unless the fabricator is registered and approved to perform such work without special inspection with approval of Engineer, or unless otherwise specified in these specifications.

** END OF SECTION **

SECTION 040010 CUTTING AND PATCHING

PART 1 - GENERAL

1.1 CUTTING AND PATCHING PROPOSAL

- A. Where approval of procedures is required before proceeding, submit a proposal describing procedures in advance of the time cutting and patching will be performed. Include the following information, as applicable:
1. Describe the extent of cutting and patching required and how it is to be performed. Indicate why it cannot be avoided.
 2. Describe anticipated results, include changes to structural elements and operating components and changes in the building's appearance and other visual elements.
 3. List products to be used and entities that will perform work.
 4. Indicate dates when cutting and patching is to be performed.
 5. List utilities that will be disturbed, including those that will be relocated and those that will be temporarily out-of service. Indicate how long service will be disrupted.
 6. Approval by the Owner's Representative to proceed does not waive the Owner's Representative right to later require complete removal and replacement of work found to be unsatisfactory.

1.2 STRUCTURAL WORK

- A. Do not cut and patch structural elements in a manner that would reduce the load-carrying capacity or load deflection ratio. Obtain approval of the cutting and patching proposal before cutting and patching structural elements.

1.3 OPERATIONAL AND SAFETY LIMITATIONS

- A. Do not cut and patch operating elements or safety components in a manner that would reduce their capacity to perform as intended, or would increase maintenance, or decrease operational life or safety. Obtain approval of the cutting and patching proposal before cutting and patching operating elements or safety related systems.

1.4 VISUAL REQUIREMENTS

- A. Do not cut and patch construction exposed on the exterior or in occupied spaces in a manner that would reduce the building's aesthetic qualities or result in visual evidence of cutting and patching. Remove and replace Work cut and patched in a visually unsatisfactory manner.

PART 2 - PRODUCTS

2.1 MATERIALS

- A. Use materials identical to existing materials. If identical materials are not available or cannot be used where exposed surfaces are involved, use materials that match existing adjacent surfaces to the fullest extent possible. Use materials whose performance will equal or surpass that of existing materials.

PART 3 - EXECUTION

3.1 EXAMINATION

- A. Before cutting, examine surfaces to be cut and patched and conditions under which cutting and patching is to be performed. Take corrective action before proceeding if unsafe or unsatisfactory conditions are encountered.

3.2 PREPARATION

- A. Provide temporary support of work to be cut.

3.3 CLEANING

- A. Thoroughly clean areas and spaces where cutting and patching is performed or used as access. Remove paint, mortar, oils, putty and similar items. Thoroughly clean piping, conduit, and similar features before painting or finishing is applied. Restore damaged pipe covering to its original condition.

3.4 PROTECTION

- A. Protect existing construction during cutting and patching to prevent damage. Provide protection from adverse weather conditions for portions that might be exposed during cutting and patching operations.
- B. Avoid interference with use of adjoining areas or interruption of free passage to adjoining areas.
- C. Take all precautions to avoid cutting existing pipe, conduit, or ductwork serving the building, but scheduled to be removed, or relocated until provisions have been made to bypass them.

3.5 PERFORMANCE

- A. Employ skilled workmen to perform cutting and patching. Proceed with cutting and patching at the earliest feasible time and complete without delay.

- B. Cut existing construction to provide for the installation of other components or the performance of other construction activities and the subsequent fitting and patching required to restore surfaces to their original condition.

3.6 CUTTING

- A. Cut existing construction using methods least likely to damage elements to be retained or adjoining construction. Where possible, review procedures with the original installer. Comply with the original installer's recommendations.
- B. All cutting of areas shall be by Contractor requiring cutting, except where noted otherwise in the Specifications and/or Drawings.
- C. Where cutting is required, use hand or small power tools designed for sawing or grinding, not hammering and chopping. Cut holes and slots to size required with minimum disturbance of adjacent surfaces. Temporarily cover openings when not in use. To avoid marring existing finished surfaces, cut or drill from the exposed or finished side into concealed surfaces.
- D. Cut through concrete and masonry using a cutting machine such as a carborundum saw or diamond core drill. Overcuts are **not** permitted.

3.7 PATCHING

- A. Patch with durable seams that are as invisible as possible. Comply with specified tolerances.
- B. All patching shall be by Contractor doing cutting work and shall be performed by trade who would customarily be performing that type of work.

- C. Restore exposed finishes of patched areas and extend finish restoration into retained adjoining construction in a manner that will eliminate evidence of patching and refinishing.
 - 1. Where patching occurs in a smooth painted surface, extend final paint coat over entire unbroken surface containing the patch, after the patched area has received primer and second coat.
 - 2. Patch, point or grout flush all voids, holes, chips, cracks, spalls, broken or otherwise damaged surfaces. Patch with materials which match adjacent surfaces in appearance and quality

- D. Repair surfaces exposed by removed finishes or equipment.

** END OF SECTION **

**SECTION 040020
CONSTRUCTION WASTE AND DISPOSAL**

PART 1 - GENERAL

1.1 DEFINITIONS

- A. Construction Waste: Building and site improvement materials and other solid waste resulting from construction, remodeling, renovation, or repair operations. Construction waste includes packaging.
- B. Disposal: Removal off-site of construction waste and subsequent sale, recycling, reuse, or deposit in landfill or incinerator acceptable to authorities having jurisdiction.
- C. Salvage and Reuse: Recovery of construction waste and subsequent incorporation into the Work.

1.2 QUALITY ASSURANCE

- A. Regulatory Requirements: Comply with hauling and disposal regulations of authorities having jurisdiction.

PART 2 - RODUCTS (not used)

PART 3 - EXECUTION

3.1 DISPOSAL OF WASTE

- A. General: Except for items or materials to be salvaged, recycled, or otherwise reused, remove waste materials from Project site and legally dispose of them in a landfill or incinerator acceptable to authorities having jurisdiction.
 - 1. Except as otherwise specified, do not allow waste materials that are to be disposed of accumulate on-site.
 - 2. Remove and transport debris in a manner that will prevent spillage on adjacent surfaces and areas.
- B. Burning: Do not burn waste materials.
- C. Disposal: Transport waste materials off Owner's property and legally dispose of them.

**** END OF SECTION ****

SECTION 060010
TEMPORARY FACILITIES AND CONTROLS

PART 1 - GENERAL

1.1 SUMMARY

- A. This section includes requirements for temporary facilities and controls, including temporary utilities, support facilities, and security and protection facilities.
- B. Temporary utilities include, but are not limited to, the following:
 - 1. Temporary Sanitary facilities, including toilets, wash facilities, and drinking-water facilities.
 - 2. Temporary Ventilation.
 - 3. Telephone and Electric service.
 - 4. Temporary heat.
 - 5. Temporary lighting.
- C. Support facilities include, but are not limited to, the following:
 - 1. Temporary roads and paving.
 - 2. Temporary Field Office Trailer.
 - 3. Dewatering facilities and drains.
 - 4. Project identification and temporary signs.
 - 5. Waste disposal facilities.
 - 6. Lifts and hoists.
 - 7. Construction aids and miscellaneous services and facilities.
 - 8. Self contained Toilet Units.
- D. Security and protection facilities include, but are not limited to, the following:
 - 1. Environmental protection.
 - 2. Stormwater control.
 - 3. Pest control.
 - 4. Site enclosure fence.
 - 5. Security enclosure and lockup.
 - 6. Barricades, warning signs and lights.
 - 7. Temporary enclosures.
 - 8. Temporary partitions.
 - 9. Fire Protection.

1.2 DEFINITIONS

- A. Permanent Enclosure: As determined by Owner, permanent or temporary roofing is complete, insulated, and weather tight; exterior walls are insulated and weather tight; and all openings are closed with permanent construction or substantial temporary closures.

1.3 USE CHARGES

- A. General: Cost or use charges for temporary facilities shall be included in the Contract Sum. Allow other entities to use temporary services and facilities without cost, including, but not limited to, Owner's construction forces, Owner, occupants of Project, testing agencies, and authorities having jurisdiction.
- B. Sewer Service: Pay sewer service use charges for sewer usage by all entities for construction operations.
- C. Water Service: Pay water service use charges for water used by all entities for construction operations.
- D. Electric Power Service: Pay electric power service use charges for electricity used by all entities for construction operations.
- E. Telephone / Fax Service: Pay for telephone use charges for telephone used by all entities for construction operations.

1.4 SUBMITTALS

- A. Temporary Utility Reports: Submit reports of tests, inspections, meter readings, and similar procedures performed on temporary utilities.
- B. Implementation and Termination Schedule: Within 15 days of date established for submittal of Construction Manager's Construction Schedule, submit a schedule indicating implementation and termination of each temporary utility.

1.5 QUALITY ASSURANCE

- A. Standards: Comply with ANSI A10.6, NECA's "Temporary Electrical Facilities," and NFPA 241.
 - 1. Trade Jurisdictions: Assigned responsibilities for installation and operation of temporary utilities are not intended to interfere with trade regulations and union jurisdictions.
 - 2. Electric Service: Comply with NECA, NEMA, and UL standards and regulations for temporary electric service. Install service to comply with NFPA 70.
- B. Tests and Inspections: Arrange for authorities having jurisdiction to test and inspect each temporary utility before use. Obtain required certifications and permits.

1.6 PROJECT CONDITIONS

- A. Temporary Utilities: At earliest feasible time, when acceptable to Owner, change over from use of temporary service to use of permanent service.
 - 1. Temporary Use of Permanent Facilities: Installer of each permanent service shall assume responsibility for operation, maintenance, and protection of each permanent service during its use as a construction facility before Owner's acceptance, regardless of previously assigned responsibilities.
- B. Conditions of Use: The following conditions apply to use of temporary services and facilities by all parties engaged in the Work:
 - 1. Keep temporary services and facilities clean and neat.
 - 2. Relocate temporary services and facilities as required by progress of the Work.

PART 2 – PRODUCTS

2.1 MATERIALS

- A. General: Provide new materials. Undamaged, previously used materials in serviceable condition may be used if approved by Owner. Provide materials suitable for use intended.
- B. Gypsum Board: 5/8 inch thick by 48 inches wide by maximum available lengths; Type X panels with tapered edges. Comply with ASTM C 36.
- C. Insulation: Un-faced mineral fiber blanket, manufactured from glass, slag wool, or rock wool; with maximum flame-spread and smoke developed indices of 25 and 50, respectively.
- D. Paint: Comply with requirements in Division 24 Sections "Interior and Exterior Painting."

- E. Tarpaulins: Fire resistive labeled with flame spread rating of 15 or less.
- F. Water: Potable.

2.2 EQUIPMENT

- A. General: Provide equipment suitable for use intended.
- B. Fire Extinguishers: Hand carried, portable, UL rated. Provide class and extinguishing agent as indicated or a combination of extinguishers of NFPA-recommended classes for exposures.
 - 1. Comply with NFPA 10 and NFPA 241 for classification, extinguishing agent, and size required by location and class of fire exposure.
- C. Self-Contained Toilet Units: Single occupant units of chemical, aerated re-circulation, or combustion type; vented; fully enclosed with a glass-fiber-reinforced polyester shell or similar nonabsorbent material.
- D. Power Distribution System Circuits: Where permitted and overhead and exposed for surveillance, wiring circuits, not exceeding 125-V ac, 20-A rating, and lighting circuits may be nonmetallic sheathed cable.

PART 3 – EXECUTION

3.1 INSTALLATION, GENERAL

- A. Locate facilities where they will serve Project adequately and result in minimum interference with performance of the Work. Relocate and modify facilities as required.
- B. Provide each facility ready for use when needed to avoid delay. Maintain and modify as required. Do not remove until facilities are no longer needed or are replaced by authorized use of completed permanent facilities.

3.2 TEMPORARY UTILITY INSTALLATION

- A. Water Service: Install water service and distribution piping in sizes and pressures adequate for construction activities from Owner's existing water service.
 - 1. Provide rubber hoses as necessary to serve Project site.
 - 2. Where installations below an outlet might be damaged by spillage or leakage, provide a drip pan of suitable size to minimize water damage. Drain accumulated water promptly from pans.
 - 3. Provide pumps to supply a minimum of 30-psi static pressure at highest point. Equip pumps with surge and storage tanks and automatic controls to supply water uniformly at reasonable pressures.
- B. Sewers and Drainage: Provide temporary utilities to remove effluent lawfully.

1. Connect temporary sewers to municipal system as directed by authorities having jurisdiction.
- C. Sanitary Facilities: Provide temporary toilets, wash facilities, and drinking water fixtures. Comply with regulations and health codes for type, number, location, operation, and maintenance of fixtures and facilities.
1. Disposable Supplies: Provide toilet tissue, paper towels, paper cups, and similar disposable materials for each facility. Maintain adequate supply. Provide covered waste containers for disposal of used material.
 2. Toilets: Install self contained toilet units. Shield toilets to ensure privacy.
 3. Drinking Water Facilities: Provide bottle-water, drinking-water units.
 - a. Where power is accessible, provide electric water coolers to maintain dispensed water temperature at 45 to 55 deg F.
 4. Locate toilets so personnel need not walk more than two stories vertically or 200 feet horizontally to facilities.
- D. Heating and Cooling: Provide temporary heating and cooling required by construction activities for curing or drying of completed installations or for protecting installed construction from adverse effects of low temperatures or high humidity. Select equipment from that specified that will not have a harmful effect on completed installations or elements being installed.
1. Maintain a minimum temperature as necessary, so as not to delay the project, in permanently enclosed portions of building for normal construction activities.
- E. Ventilation and Humidity Control: Provide temporary ventilation required by construction activities for curing or drying of completed installations or for protecting installed construction from adverse effects of high humidity. Select equipment from that specified that will not have a harmful effect on completed installations or elements being installed. Coordinate ventilation requirements to produce ambient condition required and minimize energy consumption.
- F. Electric Power Service: Provide electric power service and distribution system of sufficient size, capacity, and power characteristics required for construction operations from Owner's existing electric service.
1. Install electric power service overhead, unless otherwise indicated.
- G. Electric Distribution: Provide receptacle outlets adequate for connection of power tools and equipment.
1. Provide waterproof connectors to connect separate lengths of electrical power cords if single lengths will not reach areas where construction activities are in progress. Do not exceed safe length-voltage ratio.
 2. Provide warning signs at power outlets other than 110 to 120 V.

3. Provide metal conduit, tubing, or metallic cable for wiring exposed to possible damage. Provide rigid steel conduits for wiring exposed on grades, floors, decks, or other traffic areas.
 4. Provide metal conduit enclosures or boxes for wiring devices.
 5. Provide 4-gang outlets, spaced so 100 foot extension cord can reach each area for power hand tools and task lighting. Provide a separate 125-V ac, 20-A circuit for each outlet.
- H. Lighting: Provide temporary lighting with local switching that provides adequate illumination for construction operations and traffic conditions.
- I. Telephone Service: Provide temporary telephone service in common-use facilities for use by all construction personnel extended from Owner's existing service. Install one telephone line(s) for each field office.
1. Post a list of important telephone numbers.
 - a. Police and fire departments.
 - b. Ambulance service.
 - c. Construction Manager's home office.
 - d. Architect's home office.
 - e. Engineer's home office.
 - f. Owner's office.
 - g. Principal subcontractors' field and home office.
 2. Provide an answering machine on superintendent's telephone.
 3. Furnish superintendent with electronic paging device or portable two-way radio for use when away from field office.
 4. Provide a portable cellular telephone for superintendent's use in making and receiving telephone calls when away from field office.

3.3 SUPPORT FACILITIES INSTALLATION

- A. General: Comply with the following:
1. Locate sanitary facilities, and other temporary construction and support facilities for easy access.
 2. Provide incombustible construction for offices, shops, and sheds located within construction area or within 30 feet of building lines. Comply with NFPA 241.
 3. Maintain support facilities until near Substantial Completion. Remove before Substantial Completion. Personnel remaining after Substantial Completion will be permitted to use permanent facilities, under conditions acceptable to Owner.
- B. Temporary Roads and Paved Areas: Construct and maintain temporary roads and paved areas adequate for construction operations. Locate temporary roads and paved areas on Drawings.
1. Provide dust control treatment that is nonpolluting and non-tracking. Reapply treatment as required to minimize dust.

2. Prepare subgrade and install sub base and base for temporary roads and paved areas.
 3. Recondition base after temporary use, including removing contaminated material, re-grading, proof-rolling, compacting, and testing.
 4. Delay installation of final course of permanent hot-mix asphalt pavement until immediately before Substantial Completion. Repair asphalt base-course pavement before installation of final course in accordance with Division 28 Section "Asphalt Paving."
- C. Parking: Provide temporary parking areas for construction personnel.
- D. De-watering Facilities and Drains: Comply with requirements in applicable Site Sections for temporary drainage and dewatering facilities and operations not directly associated with construction activities included in individual Sections. Where feasible, use same facilities. Maintain Project site, excavations, and construction free of water.
1. Dispose of rainwater in a lawful manner that will not result in flooding Project or adjoining property nor endanger permanent Work or temporary facilities.
 2. Before connection and operation of permanent drainage piping system, provide temporary drainage where roofing or similar waterproof deck construction is completed.
- E. Project Identification and Temporary Signs: Prepare Project identification and other signs in sizes approved by the Owner and Architect. Install signs to inform public and persons seeking entrance to Project. Do not permit installation of unauthorized signs.
1. Engage an experienced sign painter to apply graphics for Project identification signs. Comply with details indicated.
 2. Prepare temporary signs to provide directional information to construction personnel and visitors.
 3. Construct signs of exterior-type Grade B-B high-density concrete form overlay plywood in sizes and thicknesses indicated. Support on posts or framing of preservative-treated wood or steel.
 4. Paint sign panel and applied graphics with exterior-grade alkyd gloss enamel over exterior primer.
- F. Waste Disposal Facilities: Provide waste-collection containers in sizes adequate to handle waste from construction operations. Containerize and clearly label hazardous, dangerous, or unsanitary waste materials separately from other waste. Comply with Division 1 Section "Execution Requirements" for progress cleaning requirements.
1. If required by authorities having jurisdiction, provide separate containers, clearly labeled, for each type of waste material to be deposited.
 2. Develop a waste management plan for Work performed on Project. Indicate types of waste materials Project will produce and estimate quantities of each type. Provide detailed information for on-site waste storage and separation of recyclable materials. Provide information on destination of each type of waste material and means to be used to dispose of all waste materials.

- G. Lifts and Hoists: Provide facilities for hoisting materials and personnel. Truck cranes and similar devices used for hoisting materials are considered "tools and equipment" and not temporary facilities.
- H. Temporary Stairs: Until permanent stairs are available, provide temporary stairs where ladders are not adequate.
- I. Temporary Use of Permanent Stairs: Cover finished, permanent stairs with protective covering of plywood or similar material so finishes will be undamaged at time of acceptance.

3.4 TEMPORARY FIELD OFFICE TRAILER

- A. Trailer: Provide temporary field office trailer within security enclosure. Portable trailer to be anchored to site on cmu. Provide built-in stairs to access temporary trailer.
- B. Office: Provide temporary fax machine, copier, telephone, and computer in the Trailer for Contractor, Owner, and Architect use. Provide table and chairs capable of seating 20 people for Job Conferences and Subcontractor Meetings.
- C. Documents: Maintain a complete set of Construction Documents, Permits, Emergency Contacts, Addenda, Bulletins, progress photos, and approved Shop Drawings in the Office Trailer for field use. All documents are to be turned over to the Owner as part of the O&M Manuals for record.

3.5 SECURITY AND PROTECTION FACILITIES INSTALLATION

- A. Temporary Erosion and Sedimentation Control: Provide measures to prevent soil erosion and discharge of soil-bearing water runoff and airborne dust to adjacent properties and walkways, according to requirements of authorities having jurisdiction.
- B. Environmental Protection: Provide protection, operate temporary facilities, and conduct construction in ways and by methods that comply with environmental regulations and that minimize possible air, waterway, and subsoil contamination or pollution or other undesirable effects. Avoid using tools and equipment that produce harmful noise. Restrict use of noisemaking tools and equipment to hours that will minimize complaints from persons or firms near Project site.
- C. Stormwater Control: Provide earthen embankments and similar barriers in and around excavations and subgrade construction, sufficient to prevent flooding by runoff of stormwater from heavy rains.
- D. Pest Control: Before foundation work has been completed, retain a local exterminator or pest-control company to recommend practices to minimize attraction and harboring of rodents, roaches, and other pests. Engage this pest control service to perform extermination and control procedures at regular intervals so Project will be free of pests and their residues at Substantial Completion. Obtain extended warranty for Owner. Perform control operations lawfully, using environmentally safe materials.

- E. Barricades, Warning Signs, and Lights: Comply with standards and code requirements for erecting structurally adequate barricades. Paint with appropriate colors, graphics, and warning signs to inform personnel and public of possible hazard. Where appropriate and needed, provide lighting, including flashing red or amber lights.
 - 1. For safety barriers, sidewalk bridges, and similar uses, provide minimum 5/8-inch-thick exterior plywood.
- F. Temporary Partitions: Erect and maintain dustproof partitions and temporary enclosures to limit dust and dirt migration and to separate areas from fumes and noise.
 - 1. Construct dustproof, floor-to-ceiling barriers of polyethylene sheets.
- G. Security Enclosure: Chain link fence surrounding entire project site with lockable gates. Provide monitored locking system. Coordinate gate locations with Owner.
- H. Temporary Fire Protection: Until fire protection needs are supplied by permanent facilities, install and maintain temporary fire-protection facilities of types needed to protect against reasonably predictable and controllable fire losses. Comply with NFPA 241.
 - 1. Provide fire extinguishers, installed on walls on mounting brackets, visible and accessible from space being served, with sign mounted above.
 - a. Field Offices: Class A stored-pressure water type extinguishers.
 - b. Other Locations: Class ABC dry-chemical extinguishers or a combination of extinguishers of NFPA-recommended classes for exposures.
 - c. Locate fire extinguishers where convenient and effective for their intended purpose; provide not less than one extinguisher on each floor at or near each usable stairwell.
 - 2. Store combustible materials in containers in fire safe locations.
 - 3. Maintain unobstructed access to fire extinguishers, fire hydrants, temporary fire-protection facilities, stairways, and other access routes for firefighting. Prohibit smoking in hazardous fire-exposure areas.
 - 4. Supervise welding operations, combustion-type temporary heating units, and similar sources of fire ignition.

3.6 OPERATION, TERMINATION AND REMOVAL

- A. Supervision: Enforce strict discipline in use of temporary facilities. To minimize waste and abuse, limit availability of temporary facilities to essential and intended uses.
- B. Maintenance: Maintain facilities in good operating condition until removal. Protect from damage caused by freezing temperatures and similar elements.
 - 1. Maintain operation of temporary enclosures, heating, cooling, humidity control, ventilation, and similar facilities on a 24-hour basis where required to achieve indicated results and to avoid possibility of damage.

2. Prevent water filled piping from freezing. Maintain markers for underground lines. Protect from damage during excavation operations.
- C. Temporary Facility Changeover: Except for using permanent fire protection as soon as available, do not change over from using temporary security and protection facilities to permanent facilities until Substantial Completion.
- D. Termination and Removal: Remove each temporary facility when need for its service has ended, when it has been replaced by authorized use of a permanent facility, or no later than Substantial Completion. Complete or, if necessary, restore permanent construction that may have been delayed because of interference with temporary facility. Repair damaged Work, clean exposed surfaces, and replace construction that cannot be satisfactorily repaired.
1. Materials and facilities that constitute temporary facilities are the property of Construction Manager. Owner reserves right to take possession of Project identification signs.
 2. Remove temporary paving not intended for or acceptable for integration into permanent paving. Where area is intended for landscape development, remove soil and aggregate fill that do not comply with requirements for fill or subsoil. Remove materials contaminated with road oil, asphalt and other petrochemical compounds, and other substances that might impair growth of plant materials or lawns. Repair or replace street paving, curbs, and sidewalks at temporary entrances, as required by authorities having jurisdiction.
 3. At Substantial Completion, clean and renovate permanent facilities used during construction period. Comply with final cleaning requirements in Division 34 Section "Closeout Procedures".

** END OF SECTION **

SECTION 060020
TEMPORARY TREE AND PLANT PROTECTION

PART 1 - GENERAL

1.1 SUMMARY

- A. Section includes general protection and pruning of existing trees and plants that are affected by execution of the Work, whether temporary or permanent construction.
- B. Related Sections:
 - 1. Section 06 "Temporary Facilities and Controls" for temporary site fencing.
 - 2. Section 28 "Site Clearing" for removing existing trees and shrubs.

1.2 DEFINITIONS

- A. Caliper: Diameter of a trunk measured by a diameter tape at 6 inches above the ground for trees up to, and including, 4-inch size; and 12 inches above the ground for trees larger than 4-inch size.
- B. Plant-Protection Zone: Area surrounding individual trees, groups of trees, shrubs, or other vegetation to be protected during construction, and indicated on Drawings.
- C. Tree-Protection Zone: Area surrounding individual trees or groups of trees to be protected during construction.
- D. Vegetation: Trees, shrubs, groundcovers, grass, and other plants.

1.3 ACTION SUBMITTALS

- A. Product Data: For each type of product indicated.
- B. Samples for Verification: For each type of the following:
 - 1. Organic Mulch: 1-quart volume of organic mulch; in sealed plastic bags labeled with composition of materials by percentage of weight and source of mulch.
 - 2. Protection-Zone Fencing: Assembled Samples of manufacturer's standard size made from full-size components.

- C. Tree Pruning Schedule: Written schedule detailing scope and extent of pruning of trees to remain that interfere with or are affected by construction.
 - 1. Species and size of tree.
 - 2. Location on site plan. Include unique identifier for each.
 - 3. Reason for pruning.
 - 4. Description of pruning to be performed.
 - 5. Description of maintenance following pruning.

1.4 INFORMATIONAL SUBMITTALS

- A. Qualification Data: For qualified arborist and tree service firm.
- B. Certification: From arborist, certifying that trees indicated to remain have been protected during construction according to recognized standards and that trees were promptly and properly treated and repaired when damaged.
- C. Maintenance Recommendations: From arborist, for care and protection of trees affected by construction during and after completing the Work.
- D. Existing Conditions: Documentation of existing trees and plantings indicated to remain, which establishes preconstruction conditions that might be misconstrued as damage caused by construction activities.
 - 1. Use sufficiently detailed photographs or videotape.
 - 2. Include plans and notations to indicate specific wounds and damage conditions of each tree or other plants designated to remain.

1.5 QUALITY ASSURANCE

- A. Arborist Qualifications: Licensed arborist in jurisdiction where Project is located.
- B. Tree Service Firm Qualifications: An experienced tree service firm that has successfully completed temporary tree and plant protection work similar to that required for this Project and that will assign an experienced, qualified arborist to Project site during execution of the Work.
- C. Pre-installation Conference: Conduct conference at Project site.
 - 1. Review methods and procedures related to temporary tree and plant protection including, but not limited to, the following:
 - a. Construction schedule. Verify availability of materials, personnel, and equipment needed to make progress and avoid delays.
 - b. Enforcing requirements for protection zones.
 - c. Arborist's responsibilities.
 - d. Field quality control.

1.6 PROJECT CONDITIONS

- A. The following practices are prohibited within protection zones:
 - 1. Storage of construction materials, debris, or excavated material.
 - 2. Parking vehicles or equipment.
 - 3. Foot traffic.
 - 4. Erection of sheds or structures.
 - 5. Impoundment of water.
 - 6. Excavation or other digging unless otherwise indicated.
 - 7. Attachment of signs to or wrapping materials around trees or plants unless otherwise indicated.
- B. Do not direct vehicle or equipment exhaust toward protection zones.
- C. Prohibit heat sources, flames, ignition sources, and smoking within or near protection zones and organic mulch.

PART 2 - PRODUCTS

2.1 MATERIALS

- A. Topsoil: Natural or cultivated top layer of the soil profile or manufactured topsoil; containing organic matter and sand, silt, and clay particles; friable, pervious, and black or a darker shade of brown, gray, or red than underlying subsoil; reasonably free of subsoil, clay lumps, gravel, and other objects more than 1 inch in diameter; and free of weeds, roots, and toxic and other nonsoil materials.
 - 1. Obtain topsoil only from well-drained sites where topsoil is 4 inches deep or more; do not obtain from bogs or marshes.
- B. Topsoil: Imported or manufactured topsoil complying with ASTM D 5268.
- C. Organic Mulch: Free from deleterious materials and suitable as a top dressing for trees and shrubs, consisting of one of the following:
 - 1. Type: Shredded hardwood.
 - 2. Size Range: 3 inches maximum, 1/2 inch minimum.
 - 3. Color: Natural.
- D. Protection-Zone Fencing: Fencing fixed in position and meeting the following requirements.
 - 1. Plastic Protection-Zone Fencing: Plastic construction fencing constructed of high-density extruded and stretched polyethylene fabric with 2-inch maximum opening in pattern and weighing a minimum of 0.4 lb/ft.; remaining flexible from minus 60 to plus 200 deg F; inert to most chemicals and acids; minimum tensile yield strength of 2000 psi and ultimate tensile strength of 2680 psi; secured with plastic bands or galvanized-steel or

stainless-steel wire ties; and supported by tubular or T-shape galvanized-steel posts spaced not more than 8 feet apart.

- a. Height: 4 feet.
- b. Color: High-visibility orange, non-fading.

PART 3 - EXECUTION

3.1 EXAMINATION

- A. Erosion and Sedimentation Control: Examine the site to verify that temporary erosion- and sedimentation-control measures are in place. Verify that flows of water redirected from construction areas or generated by construction activity do not enter or cross protection zones.
- B. For the record, prepare written report, endorsed by arborist, listing conditions detrimental to tree and plant protection.

3.2 PREPARATION

- A. Locate and clearly identify trees, shrubs, and other vegetation to remain or to be relocated. Flag each tree trunk at 54 inches above the ground.
- B. Protect tree root systems from damage caused by runoff or spillage of noxious materials while mixing, placing, or storing construction materials. Protect root systems from ponding, eroding, or excessive wetting caused by dewatering operations.
- C. Tree-Protection Zones: Mulch areas inside tree-protection zones and other areas indicated.
 1. Apply 4-inch average thickness of organic mulch. Do not place mulch within 6 inches of tree trunks.

3.3 TREE- AND PLANT-PROTECTION ZONES

- A. Protection-Zone Fencing: Install protection-zone fencing along edges of protection zones before materials or equipment are brought on the site and construction operations begin in a manner that will prevent people and animals from easily entering protected area except by entrance gates. Construct fencing so as not to obstruct safe passage or visibility at vehicle intersections where fencing is located adjacent to pedestrian walkways or in close proximity to street intersections, drives, or other vehicular circulation.
- B. Maintain protection zones free of weeds and trash.
- C. Repair or replace trees, shrubs, and other vegetation indicated to remain or be relocated that are damaged by construction operations, in a manner approved by College.

- D. Maintain protection-zone fencing and signage in good condition as acceptable to College and remove when construction operations are complete and equipment has been removed from the site.
 - 1. Do not remove protection-zone fencing, even temporarily, to allow deliveries or equipment access through the protection zone.
 - 2. Temporary access is permitted subject to preapproval in writing by arborist if a root buffer effective against soil compaction is constructed as directed by arborist. Maintain root buffer so long as access is permitted.

3.4 EXCAVATION

- A. General: Excavate at edge of protection zones and for trenches indicated within protection zones according to requirements in Section 28 "Earth Moving."
- B. Trenching near Trees: Where utility trenches are required within protection zones, hand excavate under or around tree roots or tunnel under the roots by drilling, auger boring, or pipe jacking. Do not cut main lateral tree roots or taproots; cut only smaller roots that interfere with installation of utilities. Cut roots as required for root pruning.
- C. Redirect roots in backfill areas where possible. If encountering large, main lateral roots, expose roots beyond excavation limits as required to bend and redirect them without breaking. If encountered immediately adjacent to location of new construction and redirection is not practical, cut roots approximately 3 inches back from new construction and as required for root pruning.
- D. Do not allow exposed roots to dry out before placing permanent backfill. Provide temporary earth cover or pack with peat moss and wrap with burlap. Water and maintain in a moist condition. Temporarily support and protect roots from damage until they are permanently relocated and covered with soil.

3.5 ROOT PRUNING

- A. Prune roots that are affected by temporary and permanent construction. Prune roots as follows:
 - 1. Cut roots manually by digging a trench and cutting exposed roots with sharp pruning instruments; do not break, tear, chop, or slant the cuts. Do not use a backhoe or other equipment that rips, tears, or pulls roots.
 - 2. Cut Ends: Coat cut ends of roots more than 1-1/2 inches in diameter with an emulsified asphalt or other coating formulated for use on damaged plant tissues and that is acceptable to arborist.
 - 3. Temporarily support and protect roots from damage until they are permanently redirected and covered with soil.
 - 4. Cover exposed roots with burlap and water regularly.
 - 5. Backfill as soon as possible according to requirements in Section 28 "Earth Moving."
- B. Root Pruning at Edge of Protection Zone: Prune roots flush with the edge of the protection zone, by cleanly cutting all roots to the depth of the required excavation.

- C. Root Pruning within Protection Zone: Clear and excavate by hand to the depth of the required excavation to minimize damage to root systems. Use narrow-tine spading forks, comb soil to expose roots, and cleanly cut roots as close to excavation as possible.

3.6 CROWN PRUNING

- A. Prune branches that are affected by temporary and permanent construction. Prune branches as follows:
 - 1. Prune trees to remain to compensate for root loss caused by damaging or cutting root system. Provide subsequent maintenance during Contract period as recommended by arborist.
 - 2. Pruning Standards: Prune trees according to ANSI A300 (Part 1), and the following:
 - a. Type of Pruning: Reduction.
 - b. Specialty Pruning: Restoration.
 - 3. Cut branches with sharp pruning instruments; do not break or chop.
 - 4. Do not apply pruning paint to wounds.
- B. Chip removed branches and dispose of off-site.

3.7 REGRADING

- A. Lowering Grade: Where new finish grade is indicated below existing grade around trees, slope grade beyond the protection zone. Maintain existing grades within the protection zone.
- B. Lowering Grade within Protection Zone: Where new finish grade is indicated below existing grade around trees, slope grade away from trees as recommended by arborist unless otherwise indicated.
 - 1. Root Pruning: Prune tree roots exposed by lowering the grade. Do not cut main lateral roots or taproots; cut only smaller roots. Cut roots as required for root pruning.
- C. Raising Grade: Where new finish grade is indicated above existing grade around trees, slope grade beyond the protection zone. Maintain existing grades within the protection zone.
- D. Minor Fill within Protection Zone: Where existing grade is 2 inches or less below elevation of finish grade, fill with topsoil. Place topsoil in a single un-compacted layer and hand grade to required finish elevations.

3.8 FIELD QUALITY CONTROL

- A. Inspections: Engage a qualified arborist to direct plant-protection measures in the vicinity of trees, shrubs, and other vegetation indicated to remain and to prepare inspection reports.

3.9 REPAIR AND REPLACEMENT

- A. General: Repair or replace trees, shrubs, and other vegetation indicated to remain or be relocated that are damaged by construction operations, in a manner approved by Owner.
 - 1. Submit details of proposed root cutting and tree and shrub repairs.
 - 2. Have arborist perform the root cutting, branch pruning, and damage repair of trees and shrubs.
 - 3. Treat damaged trunks, limbs, and roots according to arborist's written instructions.
 - 4. Perform repairs within 24 hours.
 - 5. Replace vegetation that cannot be repaired and restored to full-growth status, as determined by Owner.
- B. Trees: Remove and replace trees indicated to remain that are more than 25 percent dead or in an unhealthy condition before the end of the corrections period or are damaged during construction operations that Owner determines are incapable of restoring to normal growth pattern.
 - 1. Provide new trees of same size and species as those being replaced for each tree that measures 6 inches or smaller in caliper size.
 - 2. Provide one new tree of 6-inch caliper size for each tree being replaced that measures more than 6 inches in caliper size.
 - a. Species: Species selected by Owner.
- C. Soil Aeration: Aerate surface soil compacted during construction. Aerate 10 feet beyond drip line and no closer than 36 inches to tree trunk. Drill 2-inch diameter holes a minimum of 12 inches deep at 24 inches o.c. Backfill holes with an equal mix of augered soil and sand.

3.10 DISPOSAL OF SURPLUS AND WASTE MATERIALS

- A. Disposal: Remove excess excavated material, displaced trees, trash and debris, and legally dispose of them off Owner's property.

** END OF SECTION **

**SECTION 080010
ETHYLENE PROPYLENE DIENE MONOMER
(EPDM) ROOFING**

PART 1 - GENERAL

1.1 SUMMARY

A. Section Includes:

1. Adhered EPDM membrane roofing system.
2. Rigid roof insulation.

B. Related Sections:

1. Section 06 "Roof Specialties" for manufactured copings.
2. Section 24 "Joint Sealants" for joint sealants, joint fillers, and joint preparation.
3. Section 12 "Storm Drainage Piping Specialties" for roof drains.

1.2 DEFINITIONS

- A. Roofing Terminology:** See ASTM D 1079 and glossary of NRCA's "The NRCA Roofing and Waterproofing Manual" for definitions of terms related to roofing work in this Section.

1.3 PERFORMANCE REQUIREMENTS

- A. General Performance:** Installed membrane roofing and base flashings shall withstand specified uplift pressures, thermally induced movement, and exposure to weather without failure due to defective manufacture, fabrication, installation, or other defects in construction. Membrane roofing and base flashings shall remain watertight.
- B. Material Compatibility:** Provide roofing materials that are compatible with one another under conditions of service and application required, as demonstrated by membrane roofing Manufacturer based on testing and field experience.

- C. Roofing System Design: Provide membrane roofing system that is identical to systems that have been successfully tested by a qualified testing and inspecting agency to resist uplift pressure calculated according to ASCE/SEI 7.
1. Corner Uplift Pressure: 50 lbf/sq. ft.
 2. Perimeter Uplift Pressure: 34 lbf/sq. ft.
 3. Field-of-Roof Uplift Pressure: 20 lbf/sq. ft.
 4. Unless noted otherwise on structural drawings.
- D. FM Approvals Listing: Provide membrane roofing, base flashings, and component materials that comply with requirements in FM Approvals 4450 and FM Approvals 4470 as part of a membrane roofing system, and that are listed in FM Approvals' "RoofNav" for Class 1 or noncombustible construction, as applicable. Identify materials with FM Approvals' markings.
1. Fire / Windstorm Classification: Class 1A-90. Basic wind speed for 3 second gust to be 90 MPH which equates to a 75 MPH fastest wind speed. 90 MPH requirement applies to entire roof system including fasteners.
 2. Hail Resistance: MH.

1.4 SUBMITTALS

- A. Product Data: For each type of product indicated.
- B. Shop Drawings: For roofing system. Include plans, elevations, sections, details, and attachments to other work.
1. Base flashings and membrane terminations.
 2. Tapered insulation, including slopes.
 3. Roof plan showing orientation of steel roof deck and orientation of membrane roofing and fastener spacing and patterns for mechanically fastened membrane roofing.
 4. Insulation fastener patterns for corner, perimeter, and field-of-roof locations.
- C. Samples for Verification: For the following products, in Manufacturer's standard sizes:
1. Sheet roofing, of color specified, including T-shaped side and end lap seam.
 2. Roof insulation.
 3. Walkway pads.
 4. Termination bars.
 5. Battens.
 6. Six insulation fasteners of each type, length, and finish.
 7. Six roof cover fasteners of each type, length, and finish.
- D. Qualification Data: For qualified Installer and Manufacturer.
- E. Manufacturer Certificate: Signed by roofing Manufacturer certifying that membrane roofing system complies with requirements specified in "Performance Requirements" Article.
1. Submit evidence of complying with performance requirements.

- F. Product Test Reports: Based on evaluation of comprehensive tests performed by Manufacturer and witnessed by a qualified testing agency, for components of membrane roofing system.
- G. Research / Evaluation Reports: For components of membrane roofing system, from the ICC-ES.
- H. Field quality-control reports.
- I. Maintenance Data: For membrane roofing system to include in maintenance manuals.
- J. Warranties: Sample of special warranties.

1.5 QUALITY ASSURANCE

- A. Manufacturer Qualifications: A qualified Manufacturer that is UL listed and FM Approvals approved for membrane roofing system identical to that used for this Project.
- B. Installer Qualifications: A qualified firm that is approved, authorized, or licensed by membrane roofing system Manufacturer to install Manufacturer's product and that is eligible to receive Manufacturer's special warranty.
- C. Source Limitations: Obtain components including roof insulation and fasteners for membrane roofing system from same Manufacturer as membrane roofing or approved by membrane roofing Manufacturer.
- D. Fire Resistance Ratings: Where indicated, provide fire-resistance-rated roof assemblies identical to those of assemblies tested for fire resistance per ASTM E 119 by a qualified testing agency. Identify products with appropriate markings of applicable testing agency.
- E. Pre-installation Roofing Conference: Conduct conference at Project site.
 1. if applicable, testing and inspecting agency representative, roofing Installer, roofing system Manufacturer's representative, deck Installer, and installers whose work interfaces with or affects roofing, including installers of roof accessories and roof-mounted equipment.
 2. Review methods and procedures related to roofing installation, including Manufacturer's written instructions.
 3. Review and finalize construction schedule and verify availability of materials, Installer's personnel, equipment, and facilities needed to make progress and avoid delays.
 4. Examine deck substrate conditions and finishes for compliance with requirements, including flatness and fastening.
 5. Review structural loading limitations of roof deck during and after roofing.
 6. Review base flashings, special roofing details, roof drainage, roof penetrations, equipment curbs, and condition of other construction that will affect roofing system.
 7. Review governing regulations and requirements for insurance and certificates if applicable.
 8. Review temporary protection requirements for roofing system during and after installation.
 9. Review roof observation and repair procedures after roofing installation.

1.6 DELIVERY, STORAGE, AND HANDLING

- A. Deliver roofing materials to Project site in original containers with seals unbroken and labeled with Manufacturer's name, product brand name and type, date of manufacture, approval or listing agency markings, and directions for storing and mixing with other components.
- B. Store liquid materials in their original undamaged containers in a clean, dry, protected location and within the temperature range required by roofing system Manufacturer. Protect stored liquid material from direct sunlight.
 - 1. Discard and legally dispose of liquid material that cannot be applied within its stated shelf life.
- C. Protect roof insulation materials from physical damage and from deterioration by sunlight, moisture, soiling, and other sources. Store in a dry location. Comply with insulation Manufacturer's written instructions for handling, storing, and protecting during installation.
- D. Handle and store roofing materials and place equipment in a manner to avoid permanent deflection of deck.

1.7 PROJECT CONDITIONS

- A. Weather Limitations: Proceed with installation only when existing and forecasted weather conditions permit roofing system to be installed according to Manufacturer's written instructions and warranty requirements.

1.8 WARRANTY

- A. Special Warranty: Manufacturer's standard or customized form, without monetary limitation, in which Manufacturer agrees to repair or replace components of membrane roofing system that fail in materials or workmanship within specified warranty period.
 - 1. Special warranty includes membrane roofing, base flashings, roof insulation, insulation accessories, fasteners, roofing accessories, roof walkway pads, and other components of membrane roofing system.
 - 2. Warranty Period: **Twenty years** from date of Substantial Completion.
- B. Special Project Warranty: Submit roofing Installer's warranty, on warranty form at end of this Section, signed by Installer, covering Work of this Section, including all components of membrane roofing system such as membrane roofing, base flashing, roof insulation, fasteners, and roof walkway products, for the following warranty period:
 - 1. Warranty Period: **Two years** from date of Substantial Completion.

PART 2 - PRODUCTS

2.1 EPDM MEMBRANE ROOFING

- A. EPDM: ASTM D 4637, Type I, non-reinforced, uniform, flexible EPDM sheet.
 - 1. Manufacturers: Subject to compliance with requirements, provide products by one of the following:
 - a. Carlisle SynTec Incorporated.
 - b. Firestone Building Products.
 - c. Versico Incorporated.
 - 2. Thickness: **60 mils**, nominal.
 - 3. Exposed Face Color: **Black**.

2.2 AUXILIARY MEMBRANE ROOFING MATERIALS

- A. General: Auxiliary membrane roofing materials recommended by roofing system Manufacturer for intended use and compatible with membrane roofing.
- B. Sheet Flashing: 60-mil-thick EPDM, partially cured or cured, according to application.
- C. Bonding Adhesive: Manufacturer's standard.
- D. Seaming Material: Manufacturer's standard, synthetic-rubber polymer primer and 3-inch-wide minimum, butyl splice tape with release film.
- E. Lap Sealant: Manufacturer's standard, single-component sealant, colored to match membrane roofing.
- F. Water Cutoff Mastic: Manufacturer's standard butyl mastic sealant.
- G. Metal Termination Bars: Manufacturer's standard, predrilled stainless-steel or aluminum bars, approximately 1 by 1/8 inch thick; with anchors.
- H. Metal Battens: Manufacturer's standard, aluminum-zinc-alloy-coated or zinc-coated steel sheet, approximately 1 inch wide by 0.05 inch thick, pre-punched.
- I. Fasteners: Factory-coated steel fasteners and metal or plastic plates complying with corrosion-resistance provisions in FM Approvals 4470, designed for fastening membrane to substrate, and acceptable to roofing system Manufacturer.
- J. Miscellaneous Accessories: Provide pourable sealers, preformed cone and vent sheet flashings, preformed inside and outside corner sheet flashings, reinforced EPDM securement strips, T-joint covers, in-seam sealants, termination reglets, cover strips, and other accessories.

2.3 ROOF INSULATION

- A. General: Preformed roof insulation boards manufactured or approved by EPDM membrane roofing Manufacturer, selected from Manufacturer's standard sizes suitable for application, of thicknesses indicated.
- B. Polyisocyanurate Board Insulation: ASTM C 1289, Type II, Class 1, felt or glass-fiber mat facer on both major surfaces. Minimum **R-22.4** base insulation for entire roof area.
- C. Tapered Insulation: Provide factory tapered insulation boards fabricated to minimum slope of 1/4 inch per 12 inches (1/2 inch per 12 inches minimum at crickets) unless otherwise indicated. Minimum insulation base thickness at roof drains to be **4 inches, R-22.4**. Roof drain to be low point in roof. Overflow drain to be 2" higher than primary drain to limit ponding to 2" if primary drain becomes clogged. Secondary drain to be piped separately from primary drain. Secondary drain to spill to grade at a visible location with brass nozzle at wall near grade. Brass nozzle to be equal to **Zurn Z199** or **Mifab R1940** Downspout Nozzle, refer to Architectural and Plumbing Drawings.
- D. Provide preformed saddles, crickets, tapered edge strips, and other insulation shapes where indicated for sloping to drain. Fabricate to slopes indicated.

2.4 INSULATION ACCESSORIES

- A. General: Furnish roof insulation accessories recommended by insulation Manufacturer for intended use and compatibility with membrane roofing.
- B. Fasteners: Factory-coated steel fasteners and metal or plastic plates complying with corrosion-resistance provisions in FM Approvals 4470, designed for fastening roof insulation and cover boards to substrate, and acceptable to roofing system Manufacturer.
- C. Full Spread Applied Insulation Adhesive: Insulation Manufacturer's recommended spray applied, low rise, two component urethane adhesive formulated to attach roof insulation to substrate or to another insulation layer.
- D. Protection Mat: Woven or non-woven polypropylene, polyolefin, or polyester fabric, water permeable and resistant to UV degradation, type and weight as recommended by roofing system Manufacturer for application.

2.5 WALKWAYS

- A. Flexible Walkways: 24 inch x 24 inch, factory formed, nonporous, heavy duty, solid rubber, slip resistant, surface textured walkway pads, approximately 3/16 inch thick, and acceptable to membrane roofing system Manufacturer for use on adhered roofing areas. Install walkway pads at perimeter of all rooftop units and from roof access door to each piece of rooftop equipment. Refer to Roof Plan.
 - 1. Products: Subject to compliance with requirements, provide the following:
 - a. Carlisle SynTec Incorporated; Rubber walkway pads for use on adhered roof areas.

2. Color: **Black.**

PART 3 - EXECUTION

3.1 EXAMINATION

- A. Examine substrates, areas, and conditions, with Installer present, for compliance with the following requirements and other conditions affecting performance of roofing system:
 1. Verify that roof openings and penetrations are in place and curbs are set and braced and that roof drain bodies are securely clamped in place.
 2. Verify that wood blocking, curbs, and nailers are securely anchored to roof deck at penetrations and terminations and that nailers match thicknesses of insulation.
 3. Verify that surface plane flatness and fastening of steel roof deck complies with requirements in Division 05 Section "Steel Decking."
 4. Verify that minimum concrete drying period recommended by roofing system Manufacturer has passed.
 5. Verify that concrete substrate is visibly dry and free of moisture. Test for capillary moisture by plastic sheet method according to ASTM D 4263.
 6. Verify that concrete curing compounds that will impair adhesion of roofing components to roof deck have been removed.
- B. Proceed with installation only after unsatisfactory conditions have been corrected.

3.2 PREPARATION

- A. Clean substrate of dust, debris, moisture, and other substances detrimental to roofing installation according to roofing system Manufacturer's written instructions. Remove sharp projections.
- B. Prevent materials from entering and clogging roof drains and conductors and from spilling or migrating onto surfaces of other construction. Remove roof drain plugs when no work is taking place or when rain is forecast.
- C. Complete terminations and base flashings and provide temporary seals to prevent water from entering completed sections of roofing system at the end of the workday or when rain is forecast. Remove and discard temporary seals before beginning work on adjoining roofing.

3.3 INSULATION INSTALLATION

- A. Coordinate installing membrane roofing system components so insulation is not exposed to precipitation or left exposed at the end of the workday.
- B. Comply with membrane roofing system and insulation Manufacturer's written instructions for installing roof insulation.
- C. Install tapered insulation under area of roofing to conform to slopes indicated.

- D. Install insulation under area of roofing to achieve required thickness. Where overall insulation thickness is 2 inches or greater, install two or more layers with joints of each succeeding layer staggered from joints of previous layer a minimum of 6 inches in each direction.
 - 1. Where installing composite and non-composite insulation in two or more layers, install non-composite board insulation for bottom layer and intermediate layers, if applicable, and install composite board insulation for top layer.
- E. Trim surface of insulation where necessary at roof drains so completed surface is flush and does not restrict flow of water.
- F. Install insulation with long joints of insulation in a continuous straight line with end joints staggered between rows, abutting edges and ends between boards. Fill gaps exceeding 1/4 inch with insulation.
 - 1. Cut and fit insulation within 1/4 inch of nailers, projections, and penetrations.
- G. Adhered Insulation: Install each layer of insulation and adhere to substrate as follows:
 - 1. Prime surface of concrete deck with asphalt primer at rate of 3/4 gal./100 sq. ft. and allow primer to dry.
 - 2. Set each layer of insulation in a uniform coverage of full-spread insulation adhesive, firmly pressing and maintaining insulation in place.

3.4 ADHERED MEMBRANE ROOFING INSTALLATION

- A. Adhere membrane roofing over area to receive roofing according to membrane roofing system Manufacturer's written instructions. Unroll membrane roofing and allow to relax before installing.
- B. Start installation of membrane roofing in presence of membrane roofing system Manufacturer's technical personnel.
- C. Accurately align membrane roofing and maintain uniform side and end laps of minimum dimensions required by Manufacturer. Stagger end laps.
- D. Bonding Adhesive: Apply to substrate and underside of membrane roofing at rate required by Manufacturer and allow to partially dry before installing membrane roofing. Do not apply to splice area of membrane roofing.
- E. Apply membrane roofing with side laps shingled with slope of roof deck where possible.
- F. Adhesive Seam Installation: Clean both faces of splice areas, apply splicing cement, and firmly roll side and end laps of overlapping membrane roofing according to Manufacturer's written instructions to ensure a watertight seam installation. Apply lap sealant and seal exposed edges of membrane roofing terminations.
 - 1. Apply a continuous bead of in-seam sealant before closing splice if required by membrane roofing system Manufacturer.

- G. Repair tears, voids, and lapped seams in roofing that does not comply with requirements.
- H. Spread sealant or mastic bed over deck drain flange at roof drains and securely seal membrane roofing in place with clamping ring.

3.5 BASE FLASHING INSTALLATION

- A. Install sheet flashings and preformed flashing accessories and adhere to substrates according to membrane roofing system Manufacturer's written instructions.
- B. Apply bonding adhesive to substrate and underside of sheet flashing at required rate and allow to partially dry. Do not apply to seam area of flashing.
- C. Flash penetrations and field-formed inside and outside corners with cured or uncured sheet flashing.
- D. Clean splice areas, apply splicing cement, and firmly roll side and end laps of overlapping sheets to ensure a watertight seam installation. Apply lap sealant and seal exposed edges of sheet flashing terminations.
- E. Terminate and seal top of sheet flashings and mechanically anchor to substrate through termination bars.

3.6 WALKWAY INSTALLATION

- A. Flexible Walkways: Install walkway products in locations indicated. Adhere walkway products to substrate with compatible adhesive according to roofing system Manufacturer's written instructions.

3.7 FIELD QUALITY CONTROL

- A. Testing Agency: **Owner will engage** a qualified independent testing agency to perform inspections.
- B. Final Roof Inspection: Arrange for roofing system Manufacturer's technical personnel to inspect roofing installation on completion.
- C. Repair or remove and replace components of membrane roofing system where inspections indicate that they do not comply with specified requirements.
- D. Additional inspections, at Contractor's expense, will be performed to determine compliance of replaced or additional work with specified requirements.

3.8 PROTECTING AND CLEANING

- A. Protect membrane roofing system from damage and wear during remainder of construction period. When remaining construction will not affect or endanger roofing, inspect roofing for

deterioration and damage, describing its nature and extent in a written report, with copies to Architect and Owner.

- B. Correct deficiencies in or remove membrane roofing system that does not comply with requirements, repair substrates and repair or reinstall membrane roofing system to a condition free of damage and deterioration at time of Substantial Completion and according to warranty requirements.
- C. Clean overspray and spillage from adjacent construction using cleaning agents and procedures recommended by Manufacturer of affected construction.

3.9 ROOFING INSTALLER'S WARRANTY

A. WHEREAS <Insert name> of <Insert address>, herein called the "Roofing Installer," has performed roofing and associated work ("work") on the following project:

- 1. Owner: <Insert name of Owner>.
- 2. Address: <Insert address>.
- 3. Building Name/Type: <Insert information>.
- 4. Address: <Insert address>.
- 5. Area of Work: <Insert information>.
- 6. Acceptance Date: <Insert date>.
- 7. Warranty Period: <Insert time>.
- 8. Expiration Date: <Insert date>.

B. AND WHEREAS Roofing Installer has contracted (either directly with Owner or indirectly as a subcontractor) to warrant said work against leaks and faulty or defective materials and workmanship for designated Warranty Period,

C. NOW THEREFORE Roofing Installer hereby warrants, subject to terms and conditions herein set forth, that during Warranty Period he will, at his own cost and expense, make or cause to be made such repairs to or replacements of said work as are necessary to correct faulty and defective work and as are necessary to maintain said work in a watertight condition.

D. This Warranty is made subject to the following terms and conditions:

- 1. Specifically excluded from this Warranty are damages to work and other parts of the building, and to building contents, caused by:
 - a. Lightning;
 - b. Peak gust wind speed exceeding 90 mph;
 - c. Fire;
 - d. Failure of roofing system substrate, including cracking, settlement, excessive deflection, deterioration, and decomposition;
 - e. Faulty construction of parapet walls, copings, chimneys, skylights, vents, equipment supports, and other edge conditions and penetrations of the work;
 - f. Vapor condensation on bottom of roofing; and
 - g. Activity on roofing by others, including construction contractors, maintenance personnel, other persons, and animals, whether authorized or unauthorized by Owner.

2. When work has been damaged by any of foregoing causes, Warranty shall be null and void until such damage has been repaired by Roofing Installer and until cost and expense thereof have been paid by Owner or by another responsible party so designated.
3. Roofing Installer is responsible for damage to work covered by this Warranty but is not liable for consequential damages to building or building contents resulting from leaks or faults or defects of work.
4. During Warranty Period, if Owner allows alteration of work by anyone other than Roofing Installer, including cutting, patching, and maintenance in connection with penetrations, attachment of other work, and positioning of anything on roof, this Warranty shall become null and void on date of said alterations, but only to the extent said alterations affect work covered by this Warranty. If Owner engages Roofing Installer to perform said alterations, Warranty shall not become null and void unless Roofing Installer, before starting said work, shall have notified Owner in writing, showing reasonable cause for claim, that said alterations would likely damage or deteriorate work, thereby reasonably justifying a limitation or termination of this Warranty.
5. During Warranty Period, if original use of roof is changed and it becomes used for, but was not originally specified for, a promenade, work deck, spray-cooled surface, flooded basin, or other use or service more severe than originally specified, this Warranty shall become null and void on date of said change, but only to the extent said change affects work covered by this Warranty.
6. Owner shall promptly notify Roofing Installer of observed, known, or suspected leaks, defects, or deterioration and shall afford reasonable opportunity for Roofing Installer to inspect work and to examine evidence of such leaks, defects, or deterioration.
7. This Warranty is recognized to be the only warranty of Roofing Installer on said work and shall not operate to restrict or cut off Owner from other remedies and resources lawfully available to Owner in cases of roofing failure. Specifically, this Warranty shall not operate to relieve Roofing Installer of responsibility for performance of original work according to requirements of the Contract Documents, regardless of whether Contract was a contract directly with Owner or a subcontract with Owner's General Contractor.

E. IN WITNESS THEREOF, this instrument has been duly executed this **<Insert day>** day of **<Insert month>**, **<Insert year>**.

1. Authorized Signature: **<Insert signature>**.
2. Name: **<Insert name>**.
3. Title: **<Insert title>**.

**** END OF SECTION ****

SECTION 080020 ROOF SPECIALTIES

PART 1 - GENERAL

1.1 SUMMARY

A. Section Includes:

1. Copings.
2. Reglets and counterflashings.

B. Related Requirements:

1. Section 8 "Roof Accessories" for set-on-type curbs, equipment supports, roof hatches, vents, and other manufactured roof accessory units.
2. Section 24 "Joint Sealants" for field-applied sealants between roof specialties and adjacent materials.

C. Preinstallation Conference: Conduct conference at Project site.

1. Meet with Owner and Owner's insurer if applicable, roofing-system testing and inspecting agency representative, roofing Installer, roofing-system manufacturer's representative, Installer, structural-support Installer, and installers whose work interfaces with or affects roof specialties, including installers of roofing materials and accessories.
2. Examine substrate conditions for compliance with requirements, including flatness and attachment to structural members.
3. Review special roof details, roof drainage, and condition of other construction that will affect roof specialties.

1.2 ACTION SUBMITTALS

A. Product Data: For each type of product.

1. Include construction details, material descriptions, dimensions of individual components and profiles, and finishes.

B. Shop Drawings: For roof specialties.

1. Include plans, elevations, expansion-joint locations, keyed details, and attachments to other work. Distinguish between plant- and field-assembled work.
2. Include details for expansion and contraction; locations of expansion joints, including direction of expansion and contraction.
3. Indicate profile and pattern of seams and layout of fasteners, cleats, clips, and other attachments.
4. Detail termination points and assemblies, including fixed points.
5. Include details of special conditions.

- C. Samples: For each type of roof specialty and for each color and texture specified.
- D. Samples for Verification:
 - 1. Include Samples of each type of roof specialty to verify finish and color selection, in manufacturer's standard sizes.
 - 2. Include copings and reglets and counterflashings made from 12-inch lengths of full-size components in specified material, and including fasteners, cover joints, accessories, and attachments.

1.3 INFORMATIONAL SUBMITTALS

- A. Qualification Data: For manufacturer.
- B. Product Certificates: For each type of roof specialty.
- C. Product Test Reports: For copings, for tests performed by a qualified testing agency.
- D. Sample Warranty: For manufacturer's special warranty.

1.4 CLOSEOUT SUBMITTALS

- A. Maintenance Data: For roofing specialties to include in maintenance manuals.

1.5 QUALITY ASSURANCE

- A. Manufacturer Qualifications: A qualified manufacturer offering products meeting requirements that are FM Approvals listed for specified class and SPRI ES-1 tested to specified design pressure.
- B. Source Limitations: Obtain roof specialties approved by manufacturer providing roofing-system warranty specified in Section 8 "Ethylene Propylene Diene Monomer (EPDM)".
- C. Mockups: Build mockups to verify selections made under Sample submittals, to demonstrate aesthetic effects, and set quality standards for fabrication and installation.
 - 1. Build mockup of typical coping as shown on Drawings.
 - 2. Approval of mockups does not constitute approval of deviations from the Contract Documents contained in mockups unless Owner specifically approves such deviations in writing.
 - 3. Subject to compliance with requirements, approved mockups may become part of the completed Work if undisturbed at time of Substantial Completion.

1.6 DELIVERY, STORAGE, AND HANDLING

- A. Do not store roof specialties in contact with other materials that might cause staining, denting, or other surface damage. Store roof specialties away from uncured concrete and masonry.

- B. Protect strippable protective covering on roof specialties from exposure to sunlight and high humidity, except to extent necessary for the period of roof-specialty installation.

1.7 FIELD CONDITIONS

- A. Field Measurements: Verify profiles and tolerances of roof-specialty substrates by field measurements before fabrication, and indicate measurements on Shop Drawings.
- B. Coordination: Coordinate roof specialties with flashing, trim, and construction of parapets, roof deck, roof and wall panels, and other adjoining work to provide a leakproof, secure, and noncorrosive installation.

1.8 WARRANTY

- A. Roofing-System Warranty: Roof specialties are included in warranty provisions in Section 8 "Ethylene Propylene Diene Monomer (EPDM)".
- B. Special Warranty on Painted Finishes: Manufacturer agrees to repair finish or replace roof specialties that show evidence of deterioration of factory-applied finishes within specified warranty period.
 - 1. Fluoropolymer Finish: Deterioration includes, but is not limited to, the following:
 - a. Color fading more than 5 Hunter units when tested according to ASTM D 2244.
 - b. Chalking in excess of a No. 8 rating when tested according to ASTM D 4214.
 - c. Cracking, checking, peeling, or failure of paint to adhere to bare metal.
 - 2. Finish Warranty Period: 20 years from date of Substantial Completion.

PART 2 - PRODUCTS

2.1 PERFORMANCE REQUIREMENTS

- A. General Performance: Roof specialties shall withstand exposure to weather and resist thermally induced movement without failure, rattling, leaking, or fastener disengagement due to defective manufacture, fabrication, installation, or other defects in construction.
- B. FM Approvals' Listing: Manufacture and install copings that are listed in FM Approvals' "RoofNav" and approved for windstorm classification, Class 1-90. Identify materials with FM Approvals' markings.
- C. SPRI Wind Design Standard: Manufacture and install copings tested according to SPRI ES-1 and capable of resisting the following design pressures:
 - 1. Design Pressure: As indicated on Drawings.
- D. Thermal Movements: Allow for thermal movements from ambient and surface temperature changes to prevent buckling, opening of joints, hole elongation, overstressing of components,

failure of joint sealants, failure of connections, and other detrimental effects. Provide clips that resist rotation and avoid shear stress as a result of thermal movements. Base calculations on surface temperatures of materials due to both solar heat gain and nighttime-sky heat loss.

1. Temperature Change (Range): 120 deg F, ambient; 180 deg F, material surfaces.

2.2 COPINGS

- A. Metal Copings: Manufactured coping system consisting of metal coping cap in section lengths not exceeding 12 feet, concealed anchorage; with corner units, end cap units, and concealed splice plates with finish matching coping caps.

1. Manufacturers: Subject to compliance with requirements, available manufacturers offering products that may be incorporated into the Work include, but are not limited to, the following:

- a. Architectural Products Company.
- b. ATAS International, Inc.
- c. Castle Metal Products.
- d. Cheney Flashing Company.
- e. Hickman Company, W. P.
- f. Merchant & Evans, Inc.
- g. Metal-Era, Inc.
- h. Metal-Fab Manufacturing, LLC.
- i. Perimeter Systems; a division of Southern Aluminum Finishing Company, Inc.
- j. Petersen Aluminum Corporation.

2. Formed Aluminum Sheet Coping Caps: Aluminum sheet, 0.050 inch thick.

- a. Surface: Smooth, flat finish.
- b. Finish: Two-coat fluoropolymer.
- c. Color: As **selected by Owner** from manufacturer's full range.

3. Corners: Factory mitered and mechanically clinched and sealed watertight.
4. Coping-Cap Attachment Method: Face leg hooked to continuous cleat, fabricated from coping-cap material.

- a. Face-Leg Cleats: Concealed, continuous galvanized-steel sheet.

2.3 REGLETS AND COUNTERFLASHINGS

- A. Manufacturers: Subject to compliance with requirements, available manufacturers offering products that may be incorporated into the Work include, but are not limited to, the following:

1. Castle Metal Products.
2. Cheney Flashing Company.
3. Fry Reglet Corporation.
4. Heckmann Building Products Inc.
5. Hickman Company, W. P.

6. Keystone Flashing Company, Inc.
7. Metal-Era, Inc.
8. Metal-Fab Manufacturing, LLC.

B. Reglets: Manufactured units formed to provide secure interlocking of separate reglet and counterflashing pieces, from the following exposed metal:

1. Formed Aluminum: 0.050 inch thick.
2. Corners: Factory mitered and continuously welded.
3. Masonry Type, Embedded: Provide reglets with offset top flange for embedment in masonry mortar joint.
4. Multiuse Type, Embedded: For multiuse embedment in cast-in-place concrete and masonry mortar joints.

C. Counterflashings: Manufactured units of heights to overlap top edges of base flashings by 4 inches and in lengths not exceeding 12 feet designed to snap into reglets and compress against base flashings with joints lapped, from the following exposed metal:

1. Formed Aluminum: 0.032 inch thick.

D. Accessories:

1. Flexible-Flashing Retainer: Provide resilient plastic or rubber accessory to secure flexible flashing in reglet where clearance does not permit use of standard metal counterflashing or where reglet is provided separate from metal counterflashing.
2. Counterflashing Wind-Restraint Clips: Provide clips to be installed before counterflashing to prevent wind uplift of counterflashing lower edge.

E. Aluminum Finish: Two-coat fluoropolymer.

1. Color: As **selected by Owner** from manufacturer's full range.

2.4 MATERIALS

A. Aluminum Sheet: ASTM B 209, alloy as standard with manufacturer for finish required, with temper to suit forming operations and performance required.

2.5 UNDERLAYMENT MATERIALS

A. Self-Adhering, High-Temperature Sheet: Minimum 30 to 40 mils thick, consisting of slip-resisting polyethylene-film top surface laminated to layer of butyl or SBS-modified asphalt adhesive, with release-paper backing; cold applied. Provide primer when recommended by underlayment manufacturer.

1. Thermal Stability: ASTM D 1970; stable after testing at 240 deg F.
2. Low-Temperature Flexibility: ASTM D 1970; passes after testing at minus 20 deg F.
3. Products: Subject to compliance with requirements, available products that may be incorporated into the Work include, but are not limited to, the following:
 - a. Carlisle Coatings & Waterproofing; CCW WIP 300HT.

- b. Grace Construction Products, a unit of W. R. Grace & Co.; Grace Ice and Water Shield HT.
 - c. Henry Company; Blueskin PE200 HT.
 - d. Metal-Fab Manufacturing, LLC; MetShield.
 - e. Owens Corning; WeatherLock Metal High Temperature Underlayment.
- B. Felt: ASTM D 226, Type II (No. 30), asphalt-saturated organic felt, nonperforated.
 - C. Slip Sheet: Rosin-sized building paper, 3-lb/100 sq. ft. minimum.

2.6 MISCELLANEOUS MATERIALS

- A. Fasteners: Manufacturer's recommended fasteners, suitable for application and designed to meet performance requirements. Furnish the following unless otherwise indicated:
 - 1. Fasteners for Aluminum: Aluminum or Series 300 stainless steel.
- B. Elastomeric Sealant: ASTM C 920, elastomeric silicone polymer sealant of type, grade, class, and use classifications required by roofing-specialty manufacturer for each application.
- C. Butyl Sealant: ASTM C 1311, single-component, solvent-release butyl rubber sealant; polyisobutylene plasticized; heavy bodied for hooked-type joints with limited movement.
- D. Bituminous Coating: Cold-applied asphalt emulsion complying with ASTM D 1187.
- E. Asphalt Roofing Cement: ASTM D 4586, asbestos free, of consistency required for application.

2.7 FINISHES

- A. Comply with NAAMM's "Metal Finishes Manual for Architectural and Metal Products" for recommendations for applying and designating finishes.
- B. Protect mechanical and painted finishes on exposed surfaces from damage by applying a strippable, temporary protective covering before shipping.
- C. Appearance of Finished Work: Noticeable variations in same piece are unacceptable. Variations in appearance of adjoining components are acceptable if they are within the range of approved Samples and are assembled or installed to minimize contrast.
- D. Coil-Coated Aluminum Sheet Finishes:
 - 1. High-Performance Organic Finish: Prepare, pretreat, and apply coating to exposed metal surfaces to comply with coating and resin manufacturers' written instructions.
 - a. Two-Coat Fluoropolymer: AAMA 2605. Fluoropolymer finish containing not less than 70 percent PVDF resin by weight in color coat. Prepare, pretreat, and apply coating to exposed metal surfaces to comply with coating and resin manufacturers' written instructions.

PART 3 - EXECUTION

3.1 EXAMINATION

- A. Examine substrates, areas, and conditions, with Installer present, to verify actual locations, dimensions, and other conditions affecting performance of the Work.
- B. Examine walls, roof edges, and parapets for suitable conditions for roof specialties.
- C. Verify that substrate is sound, dry, smooth, clean, sloped for drainage where applicable, and securely anchored.
- D. Proceed with installation only after unsatisfactory conditions have been corrected.

3.2 UNDERLAYMENT INSTALLATION

- A. Self-Adhering Sheet Underlayment: Apply primer if required by manufacturer. Comply with temperature restrictions of underlayment manufacturer for installation. Apply wrinkle free, in shingle fashion to shed water, and with end laps of not less than 6 inches staggered 24 inches between courses. Overlap side edges not less than 3-1/2 inches. Roll laps with roller. Cover underlayment within 14 days.
 - 1. Apply continuously under copings and reglets and counterflashings.
 - 2. Coordinate application of self-adhering sheet underlayment under roof specialties with requirements for continuity with adjacent air barrier materials.
- B. Felt Underlayment: Install with adhesive for temporary anchorage to minimize use of mechanical fasteners under roof specialties. Apply in shingle fashion to shed water, with lapped joints of not less than 2 inches.
- C. Slip Sheet: Install with tape or adhesive for temporary anchorage to minimize use of mechanical fasteners under roof specialties. Apply in shingle fashion to shed water, with lapped joints of not less than 2 inches.

3.3 INSTALLATION, GENERAL

- A. General: Install roof specialties according to manufacturer's written instructions. Anchor roof specialties securely in place, with provisions for thermal and structural movement. Use fasteners, solder, protective coatings, separators, underlayments, sealants, and other miscellaneous items as required to complete roof-specialty systems.
 - 1. Install roof specialties level, plumb, true to line and elevation; with limited oil-canning and without warping, jogs in alignment, buckling, or tool marks.
 - 2. Provide uniform, neat seams with minimum exposure of solder and sealant.
 - 3. Install roof specialties to fit substrates and to result in weathertight performance. Verify shapes and dimensions of surfaces to be covered before manufacture.
 - 4. Torch cutting of roof specialties is not permitted.
 - 5. Do not use graphite pencils to mark metal surfaces.

- B. Metal Protection: Protect metals against galvanic action by separating dissimilar metals from contact with each other or with corrosive substrates by painting contact surfaces with bituminous coating or by other permanent separation as recommended by manufacturer.
 - 1. Coat concealed side of uncoated aluminum roof specialties with bituminous coating where in contact with wood, ferrous metal, or cementitious construction.
 - 2. Bed flanges in thick coat of asphalt roofing cement where required by manufacturers of roof specialties for waterproof performance.
- C. Expansion Provisions: Allow for thermal expansion of exposed roof specialties.
 - 1. Space movement joints at a maximum of 12 feet with no joints within 18 inches of corners or intersections unless otherwise indicated on Drawings.
 - 2. When ambient temperature at time of installation is between 40 and 70 deg F, set joint members for 50 percent movement each way. Adjust setting proportionately for installation at higher ambient temperatures.
- D. Fastener Sizes: Use fasteners of sizes that penetrate substrate not less than recommended by fastener manufacturer to achieve maximum pull-out resistance.
- E. Seal concealed joints with butyl sealant as required by roofing-specialty manufacturer.
- F. Seal joints as required for weathertight construction. Place sealant to be completely concealed in joint. Do not install sealants at temperatures below 40 deg F.

3.4 COPING INSTALLATION

- A. Install cleats, anchor plates, and other anchoring and attachment accessories and devices with concealed fasteners.
- B. Anchor copings with manufacturer's required devices, fasteners, and fastener spacing to meet performance requirements.
 - 1. Interlock face-leg drip edge into continuous cleat anchored to substrate at 16-inch centers or manufacturer's required spacing that meets performance requirements. Anchor back leg of coping with screw fasteners and elastomeric washers at 16-inch centers or manufacturer's required spacing that meets performance requirements.

3.5 REGLET AND COUNTERFLASHING INSTALLATION

- A. General: Coordinate installation of reglets and counterflashings with installation of base flashings.
- B. Embedded Reglets: See Section 24 "Cast-in-Place Concrete" and Section 24 "Unit Masonry" for installation of reglets.
- C. Surface-Mounted Reglets: Install reglets to receive flashings where flashing without embedded reglets is indicated on Drawings. Install at height so that inserted counterflashings overlap 4 inches over top edge of base flashings.

- D. Counterflashings: Insert counterflashings into reglets or other indicated receivers; ensure that counterflashings overlap 4 inches over top edge of base flashings. Lap counterflashing joints a minimum of 4 inches and bed with butyl sealant. Fit counterflashings tightly to base flashings.

3.6 CLEANING AND PROTECTION

- A. Clean exposed metal surfaces of substances that interfere with uniform oxidation and weathering.
- B. Clean and neutralize flux materials. Clean off excess solder and sealants.
- C. Remove temporary protective coverings and strippable films as roof specialties are installed. On completion of installation, clean finished surfaces, including removing unused fasteners, metal filings, pop rivet stems, and pieces of flashing. Maintain roof specialties in a clean condition during construction.
- D. Replace roof specialties that have been damaged or that cannot be successfully repaired by finish touchup or similar minor repair procedures.

** END OF SECTION **

**SECTION 080030
ROOF ACCESSORIES**

PART 1 - GENERAL

1.1 SUMMARY

A. Section Includes:

1. Roof curbs.
2. Equipment supports.
3. Preformed flashing sleeves.

B. Related Sections:

1. Section 6 "Roof Specialties" for manufactured copings, reglets, and counterflashing.

1.2 PERFORMANCE REQUIREMENTS

- A. General Performance:** Roof accessories shall withstand exposure to weather and resist thermally induced movement without failure, rattling, leaking, or fastener disengagement due to defective manufacture, fabrication, installation, or other defects in construction.

1.3 ACTION SUBMITTALS

- A. Product Data:** For each type of roof accessory indicated. Include construction details, material descriptions, dimensions of individual components and profiles, and finishes.
- B. Shop Drawings:** For roof accessories. Include plans, elevations, keyed details, and attachments to other work. Indicate dimensions, loadings, and special conditions. Distinguish between plant- and field-assembled work.
- C. Samples:** For each exposed product and for each color and texture specified, prepared on Samples of size to adequately show color.

1.4 INFORMATIONAL SUBMITTALS

- A. Coordination Drawings:** Roof plans, drawn to scale, and coordinating penetrations and roof-mounted items. Show the following:
1. Size and location of roof accessories specified in this Section.
 2. Method of attaching roof accessories to roof or building structure.
 3. Other roof-mounted items including mechanical and electrical equipment, ductwork, piping, and conduit.
 4. Required clearances.
- B. Warranty:** Sample of special warranty.

1.5 CLOSEOUT SUBMITTALS

- A. Operation and Maintenance Data: For roof accessories to include in operation and maintenance manuals.

1.6 COORDINATION

- A. Coordinate layout and installation of roof accessories with roofing membrane and base flashing and interfacing and adjoining construction to provide a leakproof, weathertight, secure, and noncorrosive installation.
- B. Coordinate dimensions with rough-in information or Shop Drawings of equipment to be supported.

1.7 WARRANTY

- A. Special Warranty on Painted Finishes: Manufacturer's standard form in which manufacturer agrees to repair finishes or replace roof accessories that show evidence of deterioration of factory-applied finishes within specified warranty period.
 - 1. Fluoropolymer Finish: Deterioration includes, but is not limited to, the following:
 - a. Color fading more than 5 Hunter units when tested according to ASTM D 2244.
 - b. Chalking in excess of a No. 8 rating when tested according to ASTM D 4214.
 - c. Cracking, checking, peeling, or failure of paint to adhere to bare metal.
 - 2. Finish Warranty Period: 20 years from date of Substantial Completion.

PART 2 - PRODUCTS

2.1 METAL MATERIALS

- A. Zinc-Coated (Galvanized) Steel Sheet: ASTM A 653, G90 (Z275) coating designation.
 - 1. Exposed Coil-Coated Finish: Prepainted by the coil-coating process to comply with ASTM A 755/A 755M. Prepare, pretreat, and apply coating to exposed metal surfaces to comply with coating and resin manufacturers' written instructions.
 - a. Two-Coat Fluoropolymer Finish: AAMA 621. System consisting of primer and fluoropolymer color topcoat containing not less than 70 percent PVDF resin by weight.
 - 2. Concealed Finish: Pretreat with manufacturer's standard white or light-colored acrylic or polyester-backer finish consisting of prime coat and wash coat, with a minimum total dry film thickness of 0.5 mil.
- B. Aluminum Sheet: ASTM B 209, manufacturer's standard alloy for finish required, with temper to suit forming operations and performance required.

1. Exposed Coil-Coated Finish: Prepare, pretreat, and apply coating to exposed metal surfaces to comply with coating and resin manufacturers' written instructions.
 - a. Two-Coat Fluoropolymer Finish: AAMA 620. System consisting of primer and fluoropolymer color topcoat containing not less than 70 percent PVDF resin by weight.
 2. Concealed Finish: Pretreat with manufacturer's standard white or light-colored acrylic or polyester-backer finish consisting of prime coat and wash coat, with a minimum total dry film thickness of 0.5 mil.
- C. Aluminum Extrusions and Tubes: ASTM B 221, manufacturer's standard alloy and temper for type of use, finished to match assembly where used, otherwise mill finished.
- D. Copper Sheet: ASTM B 370, manufacturer's standard temper.
- E. Stainless-Steel Sheet and Shapes: ASTM A 240 or ASTM A 666, Type 304.
- F. Steel Shapes: ASTM A 36, hot-dip galvanized according to ASTM A 123 unless otherwise indicated.
- G. Steel Tube: ASTM A 500, round tube.
- H. Galvanized-Steel Tube: ASTM A 500, round tube, hot-dip galvanized according to ASTM A 123.
- I. Steel Pipe: ASTM A 53, galvanized.

2.2 MISCELLANEOUS MATERIALS

- A. General: Provide materials and types of fasteners, protective coatings, sealants, and other miscellaneous items required by manufacturer for a complete installation.
- B. Polyisocyanurate Board Insulation: ASTM C 1289, thickness as indicated.
- C. Wood Nailers: Softwood lumber, pressure treated with waterborne preservatives for aboveground use, acceptable to authorities having jurisdiction, containing no arsenic or chromium, and complying with AWPA C2; not less than 1-1/2 inches thick.
- D. Security Grilles: 3/4-inch diameter, ASTM A 1011 steel bars spaced 6 inches o.c. in one direction and 12 inches o.c. in the other; factory finished as follows:
 1. Surface Preparation: Remove mill scale and rust, if any, from uncoated steel, complying with SSPC-SP 5/NACE No. 1, "White Metal Blast Cleaning," or SSPC-SP 8, "Pickling."
 2. Factory Priming for Field-Painted Finish: Apply shop primer specified below immediately after surface preparation and pretreatment.
 3. Shop Primer: Manufacturer's or fabricator's standard, fast-curing, lead- and chromate-free, universal primer; selected for resistance to normal atmospheric corrosion, for compatibility with substrate and field-applied finish paint system indicated, and for capability to provide a sound foundation for field-applied topcoats under prolonged exposure.

- E. Bituminous Coating: Cold-applied asphalt emulsion complying with ASTM D 1187.
- F. Underlayment:
 - 1. Felt: ASTM D 226, Type II (No. 30), asphalt-saturated organic felt, nonperforated.
 - 2. Polyethylene Sheet: 6-mil- thick polyethylene sheet complying with ASTM D 4397.
 - 3. Slip Sheet: Building paper, 3-lb/100 sq. ft. minimum, rosin sized.
- G. Fasteners: Roof accessory manufacturer's recommended fasteners suitable for application and metals being fastened. Match finish of exposed fasteners with finish of material being fastened. Provide nonremovable fastener heads to exterior exposed fasteners. Furnish the following unless otherwise indicated:
 - 1. Fasteners for Zinc-Coated or Aluminum-Zinc Alloy-Coated Steel: Series 300 stainless steel or hot-dip zinc-coated steel according to ASTM A 153 or ASTM F 2329.
 - 2. Fasteners for Aluminum Sheet: Aluminum or Series 300 stainless steel.
 - 3. Fasteners for Copper Sheet: Copper, hardware bronze, or passivated Series 300 stainless steel.
 - 4. Fasteners for Stainless-Steel Sheet: Series 300 stainless steel.
- H. Gaskets: Manufacturer's standard tubular or fingered design of neoprene, EPDM, PVC, or silicone or a flat design of foam rubber, sponge neoprene, or cork.
- I. Elastomeric Sealant: ASTM C 920, elastomeric silicone polymer sealant as recommended by roof accessory manufacturer for installation indicated; low modulus; of type, grade, class, and use classifications required to seal joints and remain watertight.
- J. Butyl Sealant: ASTM C 1311, single-component, solvent-release butyl rubber sealant; polyisobutylene plasticized; heavy bodied for expansion joints with limited movement.
- K. Asphalt Roofing Cement: ASTM D 4586, asbestos free, of consistency required for application.

2.3 ROOF CURBS

- A. Roof Curbs: Internally reinforced roof-curb units with integral spring-type vibration isolators and capable of supporting superimposed live and dead loads, including equipment loads and other construction indicated on Drawings; with welded or mechanically fastened and sealed corner joints, stepped integral metal cant raised the thickness of roof insulation, and integrally formed deck-mounting flange at perimeter bottom.
 - 1. Manufacturers: Subject to compliance with requirements, available manufacturers offering products that may be incorporated into the Work include, but are not limited to, the following:
 - a. AES Industries, Inc.
 - b. Curbs Plus, Inc.
 - c. Custom Solution Roof and Metal Products.
 - d. Greenheck Fan Corporation.
 - e. LM Curbs.
 - f. Metallic Products Corp.

- g. Milcor Inc.; Commercial Products Group of Hart & Cooley, Inc.
 - h. Pate Company (The).
 - i. Roof Products, Inc.
 - j. Safe Air of Illinois.
 - k. Thybar Corporation.
 - l. Vent Products Co., Inc.
- B. Size: Coordinate dimensions with roughing-in information or Shop Drawings of equipment to be supported.
- C. Loads: Refer to Mechanical drawings.
- D. Material: Zinc-coated (galvanized) or Aluminum-zinc alloy-coated steel sheet, 0.079 inch thick.
- 1. Finish: Two-coat fluoropolymer.
 - 2. Color: As **selected by Owner** from manufacturer's full range.
- E. Material: Aluminum sheet, 0.090 inch thick.
- 1. Finish: Two-coat fluoropolymer.
 - 2. Color: As **selected by Owner** from manufacturer's full range.
- F. Material: Stainless-steel sheet, 0.078 inch thick.
- 1. Finish: Manufacturer's standard.
- G. Construction:
- 1. Insulation: Factory insulated with 1-1/2-inch-thick polyisocyanurate board insulation.
 - 2. Liner: Same material as curb, of manufacturer's standard thickness and finish.
 - 3. Factory-installed wood nailer at top of curb, continuous around curb perimeter.
 - 4. On ribbed or fluted metal roofs, form deck-mounting flange at perimeter bottom to conform to roof profile.
 - 5. Fabricate curbs to minimum height of 12 inches above insulation height unless otherwise indicated.
 - 6. Top Surface: Level around perimeter with roof slope accommodated by sloping the deck-mounting flange.
 - 7. Sloping Roofs: Where roof slope exceeds 1:48, fabricate curb with perimeter curb height tapered to accommodate roof slope so that top surface of perimeter curb is level. Equip unit with water diverter or cricket on side that obstructs water flow.
 - 8. Security Grille: Provide at roof openings.

2.4 EQUIPMENT SUPPORTS

- A. Equipment Supports: Internally reinforced metal equipment supports capable of supporting superimposed live and dead loads, including equipment loads and other construction indicated on Drawings; with welded or mechanically fastened and sealed corner joints, stepped integral metal cant raised the thickness of roof insulation, and integrally formed deck-mounting flange at perimeter bottom.

1. Manufacturers: Subject to compliance with requirements, available manufacturers offering products that may be incorporated into the Work include, but are not limited to, the following:
 - a. AES Industries, Inc.
 - b. Curbs Plus, Inc.
 - c. Custom Solution Roof and Metal Products.
 - d. Greenheck Fan Corporation.
 - e. LM Curbs.
 - f. Milcor Inc.; Commercial Products Group of Hart & Cooley, Inc.
 - g. Pate Company (The).
 - h. Roof Products, Inc.
 - i. Thybar Corporation.
 - j. Vent Products Co., Inc.

- B. Size: Coordinate dimensions with roughing-in information or Shop Drawings of equipment to be supported.

- C. Loads: Refer to Mechanical drawings.

- D. Material: Zinc-coated (galvanized) or Aluminum-zinc alloy-coated steel sheet, 0.079 inch thick.
 1. Finish: Two-coat fluoropolymer.
 2. Color: As **selected by Owner** from manufacturer's full range.

- E. Material: Aluminum sheet, 0.090 inch thick.
 1. Finish: Two-coat fluoropolymer.
 2. Color: As **selected by Owner** from manufacturer's full range.

- F. Material: Stainless-steel sheet, 0.078 inch thick.
 1. Finish: Manufacturer's standard.

- G. Construction:
 1. Insulation: Factory insulated with 1-1/2-inch-thick polyisocyanurate board insulation.
 2. Liner: Same material as equipment support, of manufacturer's standard thickness and finish.
 3. Factory-installed continuous wood nailers 5-1/2 inches wide at tops of equipment supports.
 4. Metal Counterflashing: Manufacturer's standard, removable, fabricated of same metal and finish as equipment support.
 5. Fabricate equipment supports to minimum height of 12 inches above insulation height unless otherwise indicated.
 6. Sloping Roofs: Where roof slope exceeds 1:48, fabricate each support with height to accommodate roof slope so that tops of supports are level with each other. Equip supports with water diverters or crickets on sides that obstruct water flow.
 7. Security Grille: Provide at roof openings.

2.5 PREFORMED FLASHING SLEEVES

- A. Exhaust Vent Flashing: Double-walled metal flashing sleeve or boot, insulation filled, with integral deck flange, 12 inches above roof insulation high, with removable metal hood and slotted metal collar.
 - 1. Manufacturers: Subject to compliance with requirements, available manufacturers offering products that may be incorporated into the Work include, but are not limited to, the following:
 - a. Custom Solution Roof and Metal Products.
 - b. Thaler Metal USA Inc.
 - 2. Metal: Aluminum sheet, 0.063 inch thick.
 - 3. Diameter: As required for application.
 - 4. Finish: Manufacturer's standard.
- B. Vent Stack Flashing: Metal flashing sleeve, uninsulated, with integral deck flange.
 - 1. Manufacturers: Subject to compliance with requirements, available manufacturers offering products that may be incorporated into the Work include, but are not limited to, the following:
 - a. Custom Solution Roof and Metal Products.
 - b. Milcor Inc.; Commercial Products Group of Hart & Cooley, Inc.
 - c. Thaler Metal USA Inc.
 - 2. Metal: Aluminum sheet, 0.063 inch thick.
 - 3. Height: 19 inches.
 - 4. Diameter: As required for application.
 - 5. Finish: Manufacturer's standard.

2.6 GENERAL FINISH REQUIREMENTS

- A. Comply with NAAMM's "Metal Finishes Manual for Architectural and Metal Products" for recommendations for applying and designating finishes.
- B. Appearance of Finished Work: Noticeable variations in same piece are not acceptable. Variations in appearance of adjoining components are acceptable if they are within the range of approved Samples and are assembled or installed to minimize contrast.

PART 3 - EXECUTION

3.1 EXAMINATION

- A. Examine substrates, areas, and conditions, with Installer present, to verify actual locations, dimensions, and other conditions affecting performance of the Work.
- B. Verify that substrate is sound, dry, smooth, clean, sloped for drainage, and securely anchored.

- C. Verify dimensions of roof openings for roof accessories.
- D. Proceed with installation only after unsatisfactory conditions have been corrected.

3.2 INSTALLATION

- A. General: Install roof accessories according to manufacturer's written instructions.
 - 1. Install roof accessories level, plumb, true to line and elevation, and without warping, jogs in alignment, excessive oil canning, buckling, or tool marks.
 - 2. Anchor roof accessories securely in place so they are capable of resisting indicated loads.
 - 3. Use fasteners, separators, sealants, and other miscellaneous items as required to complete installation of roof accessories and fit them to substrates.
 - 4. Install roof accessories to resist exposure to weather without failing, rattling, leaking, or loosening of fasteners and seals.
- B. Metal Protection: Protect metals against galvanic action by separating dissimilar metals from contact with each other or with corrosive substrates by painting contact surfaces with bituminous coating or by other permanent separation as recommended by manufacturer.
 - 1. Coat concealed side of uncoated aluminum or stainless-steel roof accessories with bituminous coating where in contact with wood, ferrous metal, or cementitious construction.
 - 2. Underlayment: Where installing roof accessories directly on cementitious or wood substrates, install a course of felt underlayment and cover with a slip sheet, or install a course of polyethylene sheet.
 - 3. Bed flanges in thick coat of asphalt roofing cement where required by manufacturers of roof accessories for waterproof performance.
- C. Roof Curb Installation: Install each roof curb so top surface is level.
- D. Equipment Support Installation: Install equipment supports so top surfaces are level with each other.
- E. Security Grilles: Weld bar intersections and, using tamper-resistant bolts, attach the ends of bars to structural frame or primary curb walls.
- F. Preformed Flashing-Sleeve Installation: Secure flashing sleeve to roof membrane according to flashing-sleeve manufacturer's written instructions.
- G. Seal joints with elastomeric or butyl sealant as required by roof accessory manufacturer.

3.3 REPAIR AND CLEANING

- A. Galvanized Surfaces: Clean field welds, bolted connections, and abraded areas and repair galvanizing according to ASTM A 780.
- B. Touch up factory-primed surfaces with compatible primer ready for field painting according to Section 24 "Exterior Painting" and "Interior Painting."

- C. Clean exposed surfaces according to manufacturer's written instructions.
- D. Clean off excess sealants.
- E. Replace roof accessories that have been damaged or that cannot be successfully repaired by finish touchup or similar minor repair procedures.

** END OF SECTION **

**SECTION 100010
HOLLOW METAL DOORS AND FRAMES**

PART 1 - GENERAL

1.1 SUMMARY

- A. Section includes hollow-metal work.
- B. Related Requirements:
 - 1. Section 10 "Door Hardware" for door hardware for hollow-metal doors.

1.2 DEFINITIONS

- A. Minimum Thickness: Minimum thickness of base metal without coatings according to NAAMM-HMMA 803 or SDI A250.8.

1.3 COORDINATION

- A. Coordinate anchorage installation for hollow-metal frames. Furnish setting drawings, templates, and directions for installing anchorages, including sleeves, concrete inserts, anchor bolts, and items with integral anchors. Deliver such items to Project site in time for installation.

1.4 PREINSTALLATION MEETINGS

- A. Preinstallation Conference: Conduct conference at Project site.

1.5 ACTION SUBMITTALS

- A. Product Data: For each type of product.
 - 1. Include construction details, material descriptions, core descriptions, fire-resistance ratings, temperature-rise ratings, and finishes.
- B. Shop Drawings: Include the following:
 - 1. Elevations of each door type.
 - 2. Details of doors, including vertical- and horizontal-edge details and metal thicknesses.
 - 3. Frame details for each frame type, including dimensioned profiles and metal thicknesses.
 - 4. Locations of reinforcement and preparations for hardware.
 - 5. Details of each different wall opening condition.
 - 6. Details of anchorages, joints, field splices, and connections.
 - 7. Details of accessories.
 - 8. Details of moldings, removable stops, and glazing.
 - 9. Details of conduit and preparations for power, signal, and control systems.

C. Samples for Verification:

1. For each type of exposed finish required, prepared on Samples of not less than 3 by 5 inches.
2. For "Doors" and "Frames" subparagraphs below, prepare Samples approximately 12 by 12 inches to demonstrate compliance with requirements for quality of materials and construction:
 - a. Doors: Show vertical-edge, top, and bottom construction; core construction; and hinge and other applied hardware reinforcement. Include separate section showing glazing if applicable.
 - b. Frames: Show profile, corner joint, floor and wall anchors, and silencers. Include separate section showing fixed hollow-metal panels and glazing if applicable.

D. Schedule: Provide a schedule of hollow-metal work prepared by or under the supervision of supplier, using same reference numbers for details and openings as those on Drawings. Coordinate with final Door Hardware Schedule.

1.6 INFORMATIONAL SUBMITTALS

- A. Product Test Reports: For each type of hollow-metal door and frame assembly, for tests performed by a qualified testing agency.
- B. Oversize Construction Certification: For assemblies required to be fire rated and exceeding limitations of labeled assemblies.

1.7 DELIVERY, STORAGE, AND HANDLING

- A. Deliver hollow-metal work palletized, packaged, or crated to provide protection during transit and Project-site storage. Do not use nonvented plastic.
 1. Provide additional protection to prevent damage to factory-finished units.
- B. Deliver welded frames with two removable spreader bars across bottom of frames, tack welded to jambs and mullions.
- C. Store hollow-metal work vertically under cover at Project site with head up. Place on minimum 4-inch high wood blocking. Provide minimum 1/4-inch space between each stacked door to permit air circulation.

PART 2 - PRODUCTS

2.1 MANUFACTURERS

- A. Manufacturers: Subject to compliance with requirements, available manufacturers offering products that may be incorporated into the Work include, but are not limited to, the following:
 1. Amweld International, LLC.

2. Apex Industries, Inc.
3. Ceco Door Products; an Assa Abloy Group company.
4. Commercial Door & Hardware Inc.
5. Concept Frames, Inc.
6. Curries Company; an Assa Abloy Group company.
7. Custom Metal Products.
8. Daybar.
9. Deansteel.
10. de La Fontaine Industries.
11. DKS Steel Door & Frame Sys. Inc.
12. Door Components, Inc.
13. Fleming-Baron Door Products.
14. Gensteel Doors Inc.
15. Greensteel Industries, Ltd.
16. HMF Express.
17. Hollow Metal Inc.
18. Hollow Metal Xpress.
19. J/R Metal Frames Manufacturing, Inc.
20. Karpen Steel Custom Doors & Frames.
21. L.I.F. Industries, Inc.
22. LaForce, Inc.
23. Megamet Industries, Inc.
24. Mesker Door Inc.
25. Michbi Doors Inc.
26. MPI Group, LLC (The).
27. National Custom Hollow Metal.
28. North American Door Corp.
29. Philipp Manufacturing Co (The).
30. Pioneer Industries, Inc.
31. Premier Products, Inc.
32. Republic Doors and Frames.
33. Rocky Mountain Metals, Inc.
34. Security Metal Products Corp.
35. Shanahans Manufacturing Ltd.
36. Steelcraft; an Ingersoll-Rand company.
37. Steward Steel; Door Division.
38. Stiles Custom Metal, Inc.
39. Titan Metal Products, Inc.
40. Trillium Steel Doors Limited.
41. West Central Mfg. Inc.

- B. Source Limitations: Obtain hollow-metal work from single source from single manufacturer.

2.2 REGULATORY REQUIREMENTS

- A. Fire-Rated Assemblies: Complying with NFPA 80 and listed and labeled by a qualified testing agency acceptable to authorities having jurisdiction for fire-protection ratings indicated, based on testing at positive pressure according to NFPA 252 or UL 10C.

- B. Fire-Rated, Borrowed-Light Assemblies: Complying with NFPA 80 and listed and labeled by a testing and inspecting agency acceptable to authorities having jurisdiction for fire-protection ratings indicated, based on testing according to NFPA 257 or UL 9.

2.3 INTERIOR DOORS AND FRAMES

- A. Construct interior doors and frames to comply with the standards indicated for materials, fabrication, hardware locations, hardware reinforcement, tolerances, and clearances, and as specified.
- B. Extra-Heavy-Duty Doors and Frames: SDI A250.8, Level 3.
 - 1. Physical Performance: Level A according to SDI A250.4.
 - 2. Doors:
 - a. Type: As indicated in the Door and Frame Schedule.
 - b. Thickness: 1-3/4 inches.
 - c. Face: Uncoated, cold-rolled steel sheet, minimum thickness of 0.053 inch.
 - d. Edge Construction: Model 2, Seamless.
 - e. Core: Manufacturer's standard kraft-paper honeycomb, polystyrene, polyurethane, polyisocyanurate, mineral-board, or vertical steel-stiffener core at manufacturer's discretion.
 - 3. Frames:
 - a. Materials: Uncoated, steel sheet, minimum thickness of 0.053 inch.
 - b. Construction: Full profile welded.
 - 4. Exposed Finish: Prime.
 - 5. Field paint with high performance coating.

2.4 EXTERIOR HOLLOW-METAL DOORS AND FRAMES

- A. Construct exterior doors and frames to comply with the standards indicated for materials, fabrication, hardware locations, hardware reinforcement, tolerances, and clearances, and as specified.
- B. Extra-Heavy-Duty Doors and Frames: SDI A250.8, Level 3.
 - 1. Physical Performance: Level A according to SDI A250.4.
 - 2. Doors:
 - a. Type: As indicated in the Door and Frame Schedule.
 - b. Thickness: 1-3/4 inches.
 - c. Face: Metallic-coated steel sheet, minimum thickness of 0.053 inch, with minimum A40 (ZF120) coating.
 - d. Edge Construction: Model 2, Seamless.

- e. Core: Manufacturer's standard kraft-paper honeycomb, polystyrene, polyurethane, polyisocyanurate, mineral-board, or vertical steel-stiffener core at manufacturer's discretion.
 - 1. Thermal-Rated Doors: Provide doors fabricated with thermal-resistance value (R-value) of not less than 2.1 deg F x h x sq. ft./Btu when tested according to ASTM C 1363.
- 3. Frames:
 - a. Materials: Metallic-coated steel sheet, minimum thickness of 0.053 inch, with minimum A40 (ZF120) coating.
 - b. Construction: Full profile welded.
- 4. Exposed Finish: Prime.
- 5. Field paint with high performance coating.

2.5 HOLLOW-METAL PANELS

- A. Provide hollow-metal panels of same materials, construction, and finish as adjacent door assemblies.

2.6 FRAME ANCHORS

- A. Jamb Anchors:
 - 1. Masonry Type: Adjustable strap-and-stirrup or T-shaped anchors to suit frame size, not less than 0.042 inch thick, with corrugated or perforated straps not less than 2 inches wide by 10 inches long; or wire anchors not less than 0.177 inch thick.
 - 2. Postinstalled Expansion Type for In-Place Concrete or Masonry: Minimum 3/8-inch-diameter bolts with expansion shields or inserts. Provide pipe spacer from frame to wall, with throat reinforcement plate, welded to frame at each anchor location.
- B. Floor Anchors: Formed from same material as frames, minimum thickness of 0.042 inch, and as follows:
 - 1. Monolithic Concrete Slabs: Clip-type anchors, with two holes to receive fasteners.

2.7 MATERIALS

- A. Cold-Rolled Steel Sheet: ASTM A 1008, Commercial Steel (CS), Type B; suitable for exposed applications.
- B. Hot-Rolled Steel Sheet: ASTM A 1011, Commercial Steel (CS), Type B; free of scale, pitting, or surface defects; pickled and oiled.
- C. Metallic-Coated Steel Sheet: ASTM A 653, Commercial Steel (CS), Type B.

- D. Frame Anchors: ASTM A 879, Commercial Steel (CS), 04Z (12G) coating designation; mill phosphatized.
 - 1. For anchors built into exterior walls, steel sheet complying with ASTM A 1008 or ASTM A 1011, hot-dip galvanized according to ASTM A 153, Class B.
- E. Inserts, Bolts, and Fasteners: Hot-dip galvanized according to ASTM A 153.
- F. Power-Actuated Fasteners in Concrete: Fastener system of type suitable for application indicated, fabricated from corrosion-resistant materials, with clips or other accessory devices for attaching hollow-metal frames of type indicated.
- G. Grout: ASTM C 476, except with a maximum slump of 4 inches, as measured according to ASTM C 143.
- H. Mineral-Fiber Insulation: ASTM C 665, Type I (blankets without membrane facing); consisting of fibers manufactured from slag or rock wool; with maximum flame-spread and smoke-developed indexes of 25 and 50, respectively; passing ASTM E 136 for combustion characteristics.
- I. Glazing: Comply with requirements in Section 24 "Glazing."
- J. Bituminous Coating: Cold-applied asphalt mastic, compounded for 15-mil dry film thickness per coat. Provide inert-type noncorrosive compound free of asbestos fibers, sulfur components, and other deleterious impurities.

2.8 FABRICATION

- A. Fabricate hollow-metal work to be rigid and free of defects, warp, or buckle. Accurately form metal to required sizes and profiles, with minimum radius for metal thickness. Where practical, fit and assemble units in manufacturer's plant. To ensure proper assembly at Project site, clearly identify work that cannot be permanently factory assembled before shipment.
- B. Hollow-Metal Doors:
 - 1. Steel-Stiffened Door Cores: Provide minimum thickness 0.026 inch, steel vertical stiffeners of same material as face sheets extending full-door height, with vertical webs spaced not more than 6 inches apart. Spot weld to face sheets no more than 5 inches o.c. Fill spaces between stiffeners with glass- or mineral-fiber insulation.
 - 2. Fire Door Cores: As required to provide fire-protection ratings indicated.
 - 3. Vertical Edges for Single-Acting Doors: Bevel edges 1/8 inch in 2 inches.
 - 4. Top Edge Closures: Close top edges of doors with flush closures of same material as face sheets.
 - 5. Bottom Edge Closures: Close bottom edges of doors with end closures or channels of same material as face sheets.
 - 6. Exterior Doors: Provide weep-hole openings in bottoms of exterior doors to permit moisture to escape. Seal joints in top edges of doors against water penetration.

- C. Hollow-Metal Frames: Where frames are fabricated in sections due to shipping or handling limitations, provide alignment plates or angles at each joint, fabricated of same thickness metal as frames.
1. Sidelight and Transom Bar Frames: Provide closed tubular members with no visible face seams or joints, fabricated from same material as door frame. Fasten members at crossings and to jambs by butt welding.
 2. Provide countersunk, flat- or oval-head exposed screws and bolts for exposed fasteners unless otherwise indicated.
 3. Grout Guards: Weld guards to frame at back of hardware mortises in frames to be grouted.
 4. Floor Anchors: Weld anchors to bottoms of jambs with at least four spot welds per anchor; however, for slip-on drywall frames, provide anchor clips or countersunk holes at bottoms of jambs.
 5. Jamb Anchors: Provide number and spacing of anchors as follows:
 - a. Masonry Type: Locate anchors not more than 16 inches from top and bottom of frame. Space anchors not more than 32 inches o.c., to match coursing, and as follows:
 - 1) Two anchors per jamb up to 60 inches high.
 - 2) Three anchors per jamb from 60 to 90 inches high.
 - 3) Four anchors per jamb from 90 to 120 inches high.
 - 4) Four anchors per jamb plus one additional anchor per jamb for each 24 inches or fraction thereof above 120 inches high.
 - b. Postinstalled Expansion Type: Locate anchors not more than 6 inches from top and bottom of frame. Space anchors not more than 26 inches o.c.
 6. Head Anchors: Two anchors per head for frames more than 42 inches wide and mounted in metal-stud partitions.
 7. Door Silencers: Except on weather-stripped frames, drill stops to receive door silencers as follows. Keep holes clear during construction.
 - a. Single-Door Frames: Drill stop in strike jamb to receive three door silencers.
 - b. Double-Door Frames: Drill stop in head jamb to receive two door silencers.
 8. Terminated Stops: Terminate stops 6 inches above finish floor with a 45-degree angle cut, and close open end of stop with steel sheet closure. Cover opening in extension of frame with welded-steel filler plate, with welds ground smooth and flush with frame.
- D. Fabricate concealed stiffeners and edge channels from either cold- or hot-rolled steel sheet.
- E. Hardware Preparation: Factory prepare hollow-metal work to receive templated mortised hardware; include cutouts, reinforcement, mortising, drilling, and tapping according to SDI A250.6, the Door Hardware Schedule, and templates.
1. Reinforce doors and frames to receive nontemplated, mortised, and surface-mounted door hardware.
 2. Comply with applicable requirements in SDI A250.6 and BHMA A156.115 for preparation of hollow-metal work for hardware.

- F. Stops and Moldings: Provide stops and moldings around glazed lites and louvers where indicated. Form corners of stops and moldings with mitered hairline joints.
1. Single Glazed Lites: Provide fixed stops and moldings welded on secure side of hollow-metal work.
 2. Multiple Glazed Lites: Provide fixed and removable stops and moldings so that each glazed lite is capable of being removed independently.
 3. Provide fixed frame moldings on outside of exterior and on secure side of interior doors and frames.
 4. Provide loose stops and moldings on inside of hollow-metal work.
 5. Coordinate rabbet width between fixed and removable stops with glazing and installation types indicated.

2.9 STEEL FINISHES

- A. Prime Finish: Clean, pretreat, and apply manufacturer's standard primer.
1. Shop Primer: Manufacturer's standard, fast-curing, lead- and chromate-free primer complying with SDI A250.10; recommended by primer manufacturer for substrate; compatible with substrate and field-applied coatings despite prolonged exposure.
- B. Field paint with high performance coating. Color to be **selected by Owner**.

2.10 ACCESSORIES

- A. Mullions and Transom Bars: Join to adjacent members by welding or rigid mechanical anchors.
- B. Grout Guards: Formed from same material as frames, not less than 0.016 inch thick.

PART 3 - EXECUTION

3.1 EXAMINATION

- A. Examine substrates, areas, and conditions, with Installer present, for compliance with requirements for installation tolerances and other conditions affecting performance of the Work.
- B. Examine roughing-in for embedded and built-in anchors to verify actual locations before frame installation.
- C. Prepare written report, endorsed by Installer, listing conditions detrimental to performance of the Work.
- D. Proceed with installation only after unsatisfactory conditions have been corrected.

3.2 PREPARATION

- A. Remove welded-in shipping spreaders installed at factory. Restore exposed finish by grinding, filling, and dressing, as required to make repaired area smooth, flush, and invisible on exposed faces.
- B. Drill and tap doors and frames to receive nontemplated, mortised, and surface-mounted door hardware.

3.3 INSTALLATION

- A. General: Install hollow-metal work plumb, rigid, properly aligned, and securely fastened in place. Comply with Drawings and manufacturer's written instructions.
- B. Hollow-Metal Frames: Install hollow-metal frames of size and profile indicated. Comply with SDI A250.11 or NAAMM-HMMA 840 as required by standards specified.
 - 1. Set frames accurately in position; plumbed, aligned, and braced securely until permanent anchors are set. After wall construction is complete, remove temporary braces, leaving surfaces smooth and undamaged.
 - a. At fire-rated openings, install frames according to NFPA 80.
 - b. Where frames are fabricated in sections because of shipping or handling limitations, field splice at approved locations by welding face joint continuously; grind, fill, dress, and make splice smooth, flush, and invisible on exposed faces.
 - c. Install frames with removable stops located on secure side of opening.
 - d. Install door silencers in frames before grouting.
 - e. Remove temporary braces necessary for installation only after frames have been properly set and secured.
 - f. Check plumb, square, and twist of frames as walls are constructed. Shim as necessary to comply with installation tolerances.
 - g. Field apply bituminous coating to backs of frames that will be filled with grout containing antifreezing agents.
 - 2. Floor Anchors: Provide floor anchors for each jamb and mullion that extends to floor, and secure with postinstalled expansion anchors.
 - a. Floor anchors may be set with power-actuated fasteners instead of postinstalled expansion anchors if so indicated and approved on Shop Drawings.
 - 3. Masonry Walls: Coordinate installation of frames to allow for solidly filling space between frames and masonry with grout.
 - 4. Concrete Walls: Solidly fill space between frames and concrete with mineral-fiber insulation.
 - 5. In-Place Concrete or Masonry Construction: Secure frames in place with postinstalled expansion anchors. Countersink anchors, and fill and make smooth, flush, and invisible on exposed faces.
 - 6. Installation Tolerances: Adjust hollow-metal door frames for squareness, alignment, twist, and plumb to the following tolerances:

- a. Squareness: Plus or minus 1/16 inch, measured at door rabbet on a line 90 degrees from jamb perpendicular to frame head.
 - b. Alignment: Plus or minus 1/16 inch, measured at jambs on a horizontal line parallel to plane of wall.
 - c. Twist: Plus or minus 1/16 inch, measured at opposite face corners of jambs on parallel lines, and perpendicular to plane of wall.
 - d. Plumbness: Plus or minus 1/16 inch, measured at jambs at floor.
- C. Hollow-Metal Doors: Fit hollow-metal doors accurately in frames, within clearances specified below. Shim as necessary.
- 1. Non-Fire-Rated Steel Doors:
 - a. Between Door and Frame Jambs and Head: 1/8 inch plus or minus 1/32 inch.
 - b. Between Edges of Pairs of Doors: 1/8 inch to 1/4 inch plus or minus 1/32 inch.
 - c. At Bottom of Door: 5/8 inch plus or minus 1/32 inch.
 - d. Between Door Face and Stop: 1/16 inch to 1/8 inch plus or minus 1/32 inch.
 - 2. Fire-Rated Doors: Install doors with clearances according to NFPA 80.
- D. Glazing: Comply with installation requirements in Section 088000 "Glazing" and with hollow-metal manufacturer's written instructions.
- 1. Secure stops with countersunk flat- or oval-head machine screws spaced uniformly not more than 9 inches o.c. and not more than 2 inches o.c. from each corner.

3.4 ADJUSTING AND CLEANING

- A. Final Adjustments: Check and readjust operating hardware items immediately before final inspection. Leave work in complete and proper operating condition. Remove and replace defective work, including hollow-metal work that is warped, bowed, or otherwise unacceptable.
- B. Remove grout and other bonding material from hollow-metal work immediately after installation.
- C. Prime-Coat Touchup: Immediately after erection, sand smooth rusted or damaged areas of prime coat and apply touchup of compatible air-drying, rust-inhibitive primer.
- D. Metallic-Coated Surface Touchup: Clean abraded areas and repair with galvanizing repair paint according to manufacturer's written instructions.
- E. Factory-Finish Touchup: Clean abraded areas and repair with same material used for factory finish according to manufacturer's written instructions.
- F. Touchup Painting: Cleaning and touchup painting of abraded areas of paint are specified in painting Sections.

** END OF SECTION **

DOORS AND FRAMES

DISTRIBUTED BY

CAPITOL DOOR AND HARDWARE CO.

774 CORPORATE CIRCLE
NEW CUMBERLAND. PA 17070
717-774-7440

HANDING CHART				REVISION	DATE	PROJECT	LENHERT BUILDING
INSIDE	H	H	INSIDE			JOB#	CDH 1090
OUTSIDE	RH E	LH E	OUTSIDE	1 - - -	1 - - -	LOCATION	MESSIAH COLLEGE GRANTHAM, PA. 17027
INSIDE	H	H	INSIDE			ARCHITECT	SPIERS, McOONALD, BHARUCHA, ROYAL 150 CORPORATE CENTER DRIVE CAMP HILL, PA 17011
OUTSIDE	RHR E	LHR	OUTSIDE	1 - - -	1 - - -	CONTRACTOR	MC COY BROTHERS, INC. 1514 COMMERCE AVENUE CARLIUSLE, PA. 17013
						DRAWN BY	C.M.H.

HOLLOW METAL DOORS AND FRAMES MANUFACTURED BY:

WOOD DOORS MANUFACTURED BY:

SHET

1 OF 27

GENERAL NOTES:

1. Fabrication of required material for this project will proceed only after receipt signed approval by the architect. Also a signed and approved copy of the finish hardware schedule and all necessary "templates will be required.

2. a) Doors and frames shall be property reinforced, drilled 13:nd tapped for mortised hardware in accordance with the finish hardware schedule. Function holes shall be provided at the factory for for locksets and exit devices. Trim mounting holes for hardware are to be drilled and tapped when required in the field bY others.
b) AU doors and frames shall be properly reirforced for surface mounted hardware in accordance with the finish hardware schedule. Drffling and tapping for attaching of surtace mounted Hardware shall be done in the field by others.

3. Doors and frames shall be thoroughly cleaned, phosphatized and receive one co-at of baked on prime coat.

4. A) All frames shall be supplied with jamb anchors per sheet [REDACTED]
B) At.lframes shall be supplied with base anchors per sheet [REDACTED]

5. All frames shall be supplied with three rubber silencers per strike jamb for single openings and two per head for double openings.

6. All glass and caulking shall be supplied and installed in the field by others.

7. All finish hardware shall be supplied by [REDACTED]

- B. All doors and frames shall be marked with [REDACTED]

9. The hardware column on the door and frame schedule sheets is for manufacturing purposes. The headings are designated after receipt of the approved hardware schedule furnished by the hardware supplier.

10. The hardware locations indicated on the door and/or frame elevation sheets are Ceco standard locations for the majority of builder's hardware. Special type hardware such as deadlocks, exit devices, etc., will also be located in accordance with Cece's standard locations for that specific hardware item and not at locations per the paper hardware templates received unless it is specifically advised by the Architect.

11. When hollow metal is used in conjUnction with aluminum, plastic laminate, structural steel and/or wood products, it will be the responsibility of the general contractor to coordinate all hardware locations:

PROJECT: LENHERT BUILDING
Job # CDH 1090

CAPITOL DOOR AND HARDWARE CO.
774 CORPORATE CIRCLE
NEW CUMBERLAND, PA 17070

DATE

REVISION

DRAWN BY

SHEET

C.M.H.

2 OF 27

GENERAL NOTES CONTINUED:

- 12. EXTERIOR HOLLOW METAL FRAMES SHALL BE:
 - A. 16 GAUGE GALVANIZED STEEL (A60)
 - B. SET UP, ARCWELDED, GROUND SMOOTH, AND PRIME PAINTED

- 13. INTERIOR HOLLOW METAL FRAMES SHALL BE:
 - A. 16 GAUGE COLD ROLLED STEEL
 - B. SET UP, ARCWELDED, GROUND SMOOTH, AND PRIME PAINTED

- 14. FRAMES WHICH ARE WELDED SHALL BE FURNISHED WITH TEMPORARY SPREADER BARS FOR STABILITY DURING SHIPMENT. THESE SHIPPING BARS ARE NOT TO BE USED AS SPREADER BARS WHILE SETTING FRAMES. IT IS THE RESPONSIBILITY OF THE INSTALLER TO PROVIDE SPREADER BARS FOR THE PROPER INSTALLATION OF FRAMES.

- 15. EXTERIOR HOLLOW METAL DOORS SHALL BE:
 - A. 16 GAUGE GALVANIZED (A60) STEEL
 - B. POLYURETHANE CORE (EXCEPT FULL GLASS THRULITE)
 - C. UNDERCUT 3/8"

- 16. INTERIOR HOLLOW METAL DOORS SHALL BE:
 - A. 18 GAUGE COLD ROLLED STEEL
 - B. HONEYCOMB CORE
 - C. UNDERCUT 3/4"

- 17. PLEASE VERIFY ALL:
 - A. JAMB DEPTHS
 - B. ANCHOR DETAILS
 - C. SIDELITE AND BORROWED LITE DIMENSIONS
 - D. HOLLOW METAL DOOR LITE SIZES AND LOCATIONS

PROJECT: LENHERT BUILDING

JOB # CDH 1090

CAPITOL DOOR AND HARDWARE CO.
774 CORPORATE CIRCLE
NEW CUMBERLAND, PA 17070

DATE

REVISION

DRAWN BY
C.M.H.

SHEET
3 OF 27

GENERAL

FIRE RATINGS

A = 3 hours
 B = 1 1/2 hours
 C = 3/4 hours

Door Thickness

4 = 1 3/4"
 8 = 1 3/8"

FRAME DATA

Series/Profile

SF = Standard frame
 CF = Custom (con_ventional) Frame
 DS = Drywall Standard Frame
 DC = Drywall Conventional Frame
 DE = Double Egress Frame
 TB = Thennal Break Frame

Special Elevation Types

BI = Borrowed lite
 SL = Sidelite
 TF = Transom
 DF = Dutch
 CO = Cased Opening
 DA = Double Acting
 CM = Communicating

DOOR DATA

R = Regent
 SR = Stainless Steel, Honeycomb core
 O = Omega
 F = Fuego
 M = Medallioil
 I = Imperial
 T = Thrulite
 SI = Stainless Steel, Urethane Foam Core
 V = Versadoor
 A = Armorshield (level 1, 2, & 3)
 A4 = Annorshield (Level 4)

Design

F = Flush
 N = Narrow light
 V = Vision light
 G = Half glass
 ■ = Louver
 FG = Full glass

<embossed panel designs>

E6 = 6 panel
 EB = 8 panel
 CBG9 = Crossbuck w/9 lights

84

SECTION OR DETAIL

SHEET NUMBERS

ABO = ALUMINUM BY OTHERS
 CIBO = CHANNEL IRON BY OTHERS
 CO = CASSED OPENING
 DA = DOUBLE ACTING (SINGLE)
 D = DOUBLE (PAIR)

PROJECT: LENHERT BUILDING
 Job # CDH 1090

CAPITOL DOOR AND HARDWARE CO.
 774 CORPORATE CIRCLE
 NEW CUMBERLAND, PA 17070

DATE

REVISION

DRAWN BY

SHEET

C.M.H.

4 OF 27

NO.	GENERAL					FRAME DATA								DOOR DATA						REMARKS	NO.
	QTY	UNIT	DESCRIPTION	FINISH	MARK	TYPE	SIZE	SW	SL	GLASS	INSULATION	GLASS	INSULATION	TYPE	SIZE	SW	SL	GLASS	INSULATION		
1	FIRST FLOOR PLAN SHEET A1.1																				
2	0111	1	3070	LHR	SF	4	16	5 3/4	1	9	MS	17	T	4	16	FG	1	20	GALV DR/FR	1	
3	01/2	1	3070	LHR	SF	4	16	5 3/4	1	9	MS	17	T	4	18	FG	1	20		28	
4	0311	1	3070	LHR	SF	4	16	5 3/4	1	9	MS	17	R	4	18	G	2	20		29	
5	04/1	1	3070	RH	SF	4	16	6 3/8	1	9	MS	17	R	4	18	N	3	20		34	
6	05/1	1	3070	RHR	SF	4	16	5 3/4	1	9	MS	17	I	4	16	G	2	20	GALV DR/FR	3	
7	0611	1	3070	LH	SF	4	16	6 3/8	1	9	MS	17	R	4	18	N	3	20		35	
8	0711	1	3070	LH	SF	4	16	6 3/8	1	9	MS	17	R	4	18	N	3	20		36	
9	08/1	1	3070	RH	SF	4	16	6 3/8	1	9	MS	17	R	4	18	N	3	20		37	
10	08/2	1	3070	LH	SF	4	16	6 3/8	1	9	MS	17	R	4	18	N	3	20		38	
11	1111	1	A	3070	RH	SF	4	16	8 5/8	1	9	MS	17	R	4	18	F	4	20	VERIFY JAMB DEPTH	44
12	1311	1	C	3070	LH	SF	4	16	4 3/4	1	9	MW	17	R	4	18	N	3	20		63
13	13/3	1	C	3070	RH	EXISTING FRAME							R	4	18	F	4	20		67	
14	1511	1	C	3070	RH	SF	4	16	4 3/4	1	9	MW	17	R	4	18	N	3	20		64
15	1611	1		3070	LH	SF	4	16	4 3/4	1	9	MW	17	R	4	18	N	3	20		65
16	1711	1		3070	RHR	SF	4	16	5 3/4	1	9	MS	17	I	4	18	G	2	20	GALV DR/FR	4
17	1811	1	C	3070	LH	SF	4	16	5 3/4	1	9	MS	17	R	4	18	N	3	20		45
18	1911	1		3070	LHR	SF	4	16	5 3/4	4	11	MS	17	I	4	16	G	2	20	Si GALV DR/FR	5
19	20/1	1	C	3070	RH	SF	4	16	5 3/4	1	9	MS	17	R	4	18	F	4	20		57
20	2111	1	C	3070	LH	SF	4	16	5 3/4	1	9	MS	17	R	4	18	F	4	20		58
21	22/1	1	C	3072	RH	SF	4	16	4 3/4	1	9	WM	17	R	4	18	F	4	20		46
22	2311	1	C	3072	LH	SF	4	16	4 3/4	1	9	WM	17	R	4	18	N	3	20		51
23	2312	1		3072	RHR	SF	4	16	4 3/4	1	9	WM	17	R	4	18	N	3	20		48
24	2411	1		3070	RHR	SF	4	16	5 3/4	1	9	MS	17	I	4	16	G	2	20	GALV DR/FR	6

PROJECT LENHART BUILDING	CAPITOL DOOR AND HARDWARE COMPANY 774 CORPORATE CIRCLE NEW CUMBERLAND, PA 17070	DATE	DRAWN BY C.M.H.
JOB # CDH 1090		REVISION	SHEET 5 OF 27

NO	SYMBOL	GENERAL				FRAME DATA								DOOR DATA					REMARKS	NO	
		QTY	DESCRIPTION	UNIT	PRICE	TYPE	SIZE	THICKNESS	WEIGHT	FINISH	GLASS	GLASS	GLASS	GLASS	GLASS	GLASS	GLASS	GLASS			GLASS
1		FIRST FLOOR PLAN SHEET A1.1 CONTINUED																			
2	25/2	1		3070	RHR	SF	4	16	4 3/4	1	9	WM	17	I	4	16	N	3	20		56
3	26/1	1	C	3070	LH	SF	4	16	4 3/4	1	9	EO	17	R	4	18	N	3	20		66
4	28/1	1	C	3072	RH	SF	4	16	4 3/4	1	9	EO	17	R	4	18	N	3	20		47
5	28/2	1		3072	LHR	SF	4	16	5 3/4	1	9	MS	17	I	4	16	F	4	20	GALV DR/FR	27
6	29 i 1	1		?	LH	EXISTING FRAME								R	4	18	F	4	20		55
7	30/1	1		3072	RHR	SF	4	16	5 3/4	1	9	MS	17	I	4	16	F	4	20	GALV DR/FR	20
8	32/1	1		4070		CF/C	CO	16	4 3/4	3	10	EO	17								
9	32 i 1a	1	C	?	RH	EXISTING FRAME								R	4	18	N	3	20		50
10	32 i 2	1	C	3070	RH	SF	4	16	4 3/4	1	9	WM	17	R	4	18	N	3	20	'EO@HINGE JAMB	52
11	32/3	1		3070	RHR	SF	4	16	5 3/4	1	9	MS	17	I	4	16	F	4	20	GALV DR/FR	7
12	33/1	1	C	2670	LH	SF	4	16	4 3/4	1	9	EO	17	R	4	18	F	4	20		52
13	34/1	1		3070	RHR	SF	4	16	5 3/4	1	9	MS	17	I	4	16	F	4	20	GALV DR/FR	8
14	34/3	1	PR	6070	RHR	SF	4	16	7 1/8	2	9	MS	17	R	4	18	F	5	21		59
15	37/1	1		3070	RH	SF	4	16	5 3/4	1	9	WS	17	R	4	18	G	2	20		39
16	38/1	1		3070	LH	SF	4	16	5 3/4	1	9	WS	17	R	4	18	G	2	20		40
17	41/1	1		3070	RHR	SF	4	16	5 3/4	1	9	EO	17	T	4	16	FG	1	20	GALV DR/FR	2
18	41/2	1		4070	LHR	SF	4	16	5 3/4	1	9	EO	17	I	4	16	F	4	20	GALV DR/FR	14
19	43/1		C	?	?	EXISTING FRAME								R	4	18	N	3	20		68
20	HM-1	1		3844		SF	4	16	5 3/4	5	12	MS	17							BIL	
21																					
22																					
23																					
24																					

PROJECT LENHERT BUILDING	CAPITOL DOOR AND HARDWARE COMPANY 774 CORPORATE CIRCLE NEW CUMBERLAND, PA 17070	DATE	DRAWN BY C.M.H.
JOB # CDH 1090		REVISION	SHEET 6 OF 27

NO	SYM	GENERAL				FRAME DATA						DOOR DATA				REMARKS	FIN			
		QTY	UNIT	DESCRIPTION	MARK	NO	UNIT	DESCRIPTION	MARK	NO	UNIT	DESCRIPTION	MARK	NO	UNIT			DESCRIPTION	MARK	
1	Z	1	3072	LHR	SF	4	16	53/4	1	9	WM	17	I	4	16	F	4	20	GALV DRIFR	24
2	50/1	1	3072	LHR	SF	4	16	53/4	1	9	WM	11	I	4	16	G	2	20	GALVDR/FR	9
3	52/1	1	3072	LHR	SF	4	16	53/4	1	9	WM	17	R	4	18	G	2	20		41
4	53/1	1	3072	LH	SF	4	16	43/4	1	9	WM	17	R	4	18	G	2	20		30
5	54/1	1	3072	RHR	SF	4	16	43/4	1	9	WM	17	R	4	18	G	2	20		31
6	54/2	1	3072	RHR	SF	4	16	43/4	1	9	WM	17	R	4	18	F	4	20		23
7	55/1	1	3072	LHR	SF	4	16	53/4	1	9	WM	17	I	4	16	G	2	20	GALVDR/FR	21
8	56/1	1	3072	RHR	SF	4	16	53/4	1	9	WM	17	I	4	16	F	4	20	GALVDR/FR	60
9	56/2	1	3072	LHR	SF	4	16	43/4	1	9	WM	17	R	4	18	G	2	20		15
10	58/2	1	3072	RHR	SF	4	16	53/4	1	9	WM	17	I	4	16	F	4	20	GALVDR/FR	10
11	59/2	1	3072	RHR	SF	4	16	53/4	1	9	WM	17	I	4	16	G	2	20	GALVDR/FR	53
12	62/1	1	3072	RH	SF	4	16	43/4	1	9	WM	17	R	4	18	F	4	20		42
13	63/1	1	3072	RH	SF	4	16	53/4	1	9	WM	17	R	4	18	G	2	20		11
14	64/1	1	3072	LHR	SF	4	16	53/4	1	9	WM	17	I	4	16	G	2	20	GALV DRIFR	16
15	64/3	1	3072	RHR	SF	4	16	53/4	1	9	WM	17	I	4	16	F	4	20	GALV DRIFR	26
16	65/1	LPR	6072	RHR	SF	4	16	53/4	2	9	WM	17	I	4	16	F	5	21	GALV DR/FR	32
17	66/1	1	3072	LH	SF	4	16	53/4	1	9	WM	17	R	4	18	F	4	20		49
18	67/1	1	3072	RHR	SF	4	16	53/4	1	9	WM	17	R	4	18	G	2	20		12
19	68/1	1	3072	RHR	SF	4	16	53/4	1	9	WM	17	I	4	16	G	2	20	GALVDR/FR	17
20	69/1	1	3072	RHR	SF	4	16	53/4	1	9	WM	17	I	4	16	F	4	20		

FIRST FLOOR PLAN SHEET A1.1a

PROJECT
LENHERT BUILDING

CAPITOL DOOR AND HARDWARE COMPANY
774 CORPORATE CIRCLE
NEW CUMBERLAND, PA 17070

DATE

DRAWN BY
C.M.H.

JOB # CDH 1090

REVISION

SHEET
7 OF 27

NO	GENERAL					FRAME DATA								DOOR DATA						REMARKS	NO
	NO	QTY	UNIT	NO	NO	NO	NO	NO	NO	NO	NO	NO	NO	NO	NO	NO	NO	NO	NO		
1	FIRST FLOOR PLAN SHEETA1.1a																				
2	7218	1		3072	LHR	SF	4	16	5 3/4	1	9	WM	17	R	4	18	F	4	20	19	
3	73 / 1	1		3072	LHR	SF	4	16	5 3/4	1	9	MS	17	R	4	18	F	4	20	33	
4	A i 1	1	C	3062	RHR	SF	4	16	5 3/4	1	9	MS	17	R	4	18	F	4	20	VERIFY DOOR HEIGHT	69
5	B / 1	1	C	3072	RHR	SF	4	16	5 3/4	1	9	MS	17	R	4	18	F	4	20	70	
6	5214	1		3072	RH	SF	4	16	4 3/4	1	9	WM	17	R	4	18	F	4	20	54	
7	5413	1		3072	LH	SF	4	16	4 3/4	1	9	WM	17	R	4	18	G	2	20	61	
8	6414	1		3072	LHR	SF	4	16	4 3/4	1	9	WM	17	R	4	18	G	2	20	62	
9	HM-2	2		3844		SF	4	16	5 3/4	5	12	WM	17							B/L	
10	HM-3	1		5044		SF	4	16	5 3/4	6	13	WM	17							B/L	
11	HM-4	1		3838		SF	4	16	4 3/4	7	14	WM	17							B/L	
12																					
13																					
14																					
15																					
16																					
17																					
18																					
19																					
20																					
21																					
22																					
23																					
24																					

PROJECT LENHERT BUILDING	JOB # CDH 1090	CAPITOL DOOR AND HARDWARE COMPANY 774 CORPORATE CIRCLE NEW CUMBERLAND, PA 17070	DATE	DRAWN BY C.M.H.
			REVISION	SHEET 8 OF 27

SERIES	
SF	(for 1-3/4" door)

PROFILES	
7"	4-7/8"
THROAT	SF
DEPTH	5-3/4"

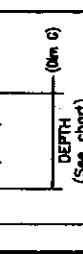
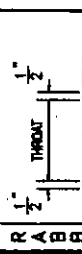
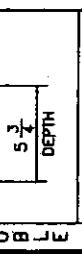
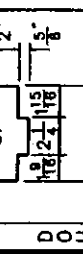
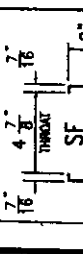

STANDARD MATERIAL:
18 Gage C.R. steel.

OPTIONAL MATERIAL:
16 Gage A60 galv. steel.
14 Gage C.R. steel.
14 Gage A60 galv. steel.

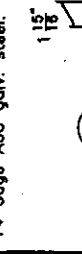

LOCK STRIKE PREPARATION

UNIVERSAL (4-7/8") (Shown)
ANSI A115.1 & 2 TEMPLATE
12 GAGE STEEL REINFORCING
(STANDARD)

CYLINDRICAL (2-3/4") (Not shown)
ANSI A115.3 TEMPLATE
18 GAGE STEEL REINFORCING
(OPTIONAL)

DEPTHS	
STANDARD DEPTHS	(In addition to 5-3/4")
Dim G = 4-3/4"	
Dim G = 6-3/4"	(Dim G) 4-1/2" thru 10-1/4"
Dim G = 7-3/4"	(in 1/8" increments)
Dim G = 8-3/4"	

SPECIAL DEPTHS	
Dim G = 4-1/2"	thru 10-1/4"
Dim G = 6-3/4"	(in 1/8" increments)

OPTIONAL FACE DIMENSIONS:
4" face head with 2" face jamb.

STANDARD FRAMES HAVE THE FOLLOWING HINGE PREP QUANTITY:
7'-6" HIGH OR SMALLER: (3) HINGE PREPS
HIGHER THAN 7'-6": (4) HINGE PREPS

HINGE SPACING	
OPENING HEIGHT	6-9
DIMENSION	A B C
1 1/2" door spacing	9" (2) AT 31"

7-0	7-2	7-10	8-0	8-0	9-0
A	B	C	A	B	C
9"	9"	9"	9"	9"	9"
(2) AT 33"	(2) AT 34"	(3) AT 25, 33"	(3) AT 28"	(3) AT 28"	(3) AT 30"

Unless otherwise indicated, frames are for 1-3/4" thick doors.
For SI conversion: 1" = 25.4 mm.

DOUBLE SWING ELEVATION I

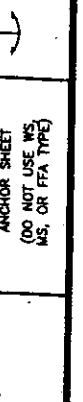
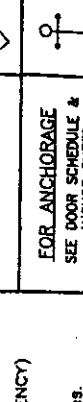
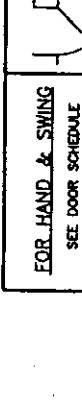
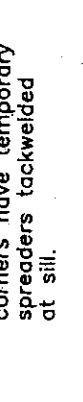
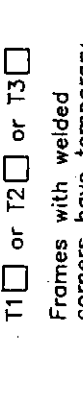
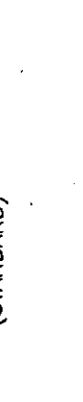
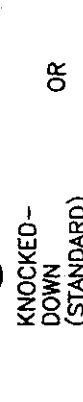
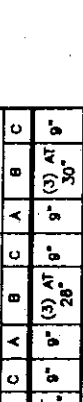
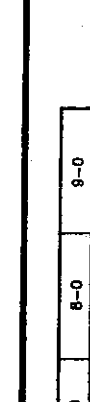
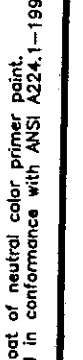
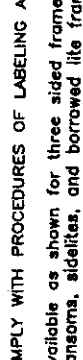
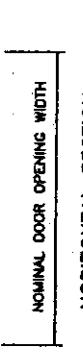
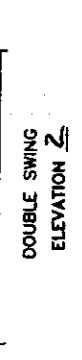
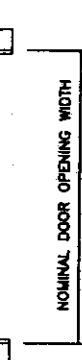
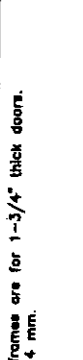
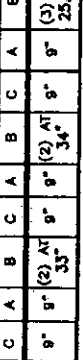
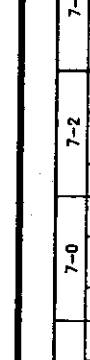
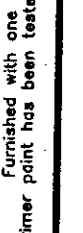
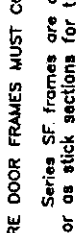
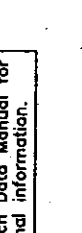
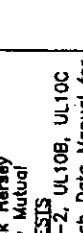
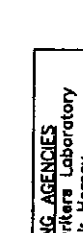
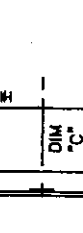
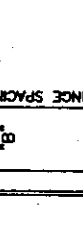
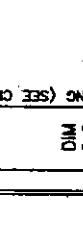
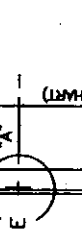
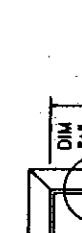

FOR HAND & SWING SEE DOOR SCHEDULE

FOR ANCHORAGE SEE DOOR SCHEDULE & ANCHOR SHEET (DO NOT USE MS, OR FFA TYPE)

WELDED CORNERS (OPTIONAL) TYPE: T1 or T2 or T3

Frames with welded corners have temporary spreaders tackwelded at sill.

Labels: Underwriters Laboratory, Warnock Hersey Factory Mutual, FIRE TESTS, UBC 7-2, UL10B, UL10C, See Tech Data Manual for additional information.

BACKSET: 5/16"

4-1/2" x 134" OR 4-1/2" x 180"

ANSI A156.7 TEMPLATE 7 GAGE STEEL REINFORCING

DOUBLE SWING ELEVATION I

SINGLE SWING ELEVATION II

NOMINAL DOOR OPENING WIDTH

DOUBLE SWING ELEVATION III

NOMINAL DOOR OPENING WIDTH

HORIZONTAL SECTION

DOUBLE SWING ELEVATION IV

NOMINAL DOOR OPENING WIDTH

HORIZONTAL SECTION

SERIES SF STEEL FRAMES

(FIRE DOOR FRAMES MUST COMPLY WITH PROCEDURES OF LABELING AGENCY)

Series SF frames are available as shown for three sided frames or as stick sections for transoms, sidelites, and borrowed lite frames. Furnished with one coat of neutral color primer paint. Primer paint has been tested in conformance with ANSI A224.1-1990.

Ceco Door Products A United Dominion Company	
DRAWN BY	DATE
CHK'D BY	DATE
SHT 9	CONTRACT NO.
OF 27	
ISSUE DATE	REVISIONS
	BY

SERIES	CF/O
16 Ga. Steel	

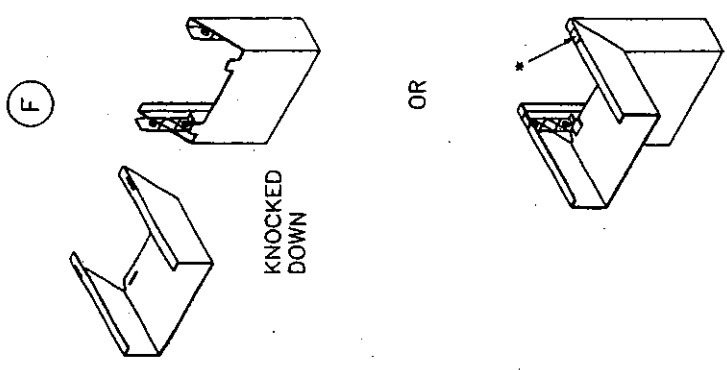
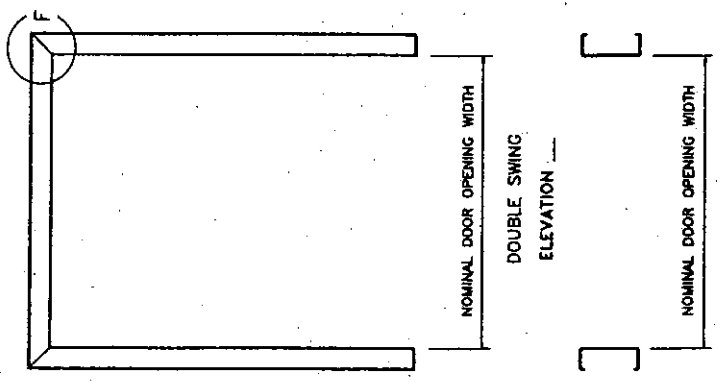
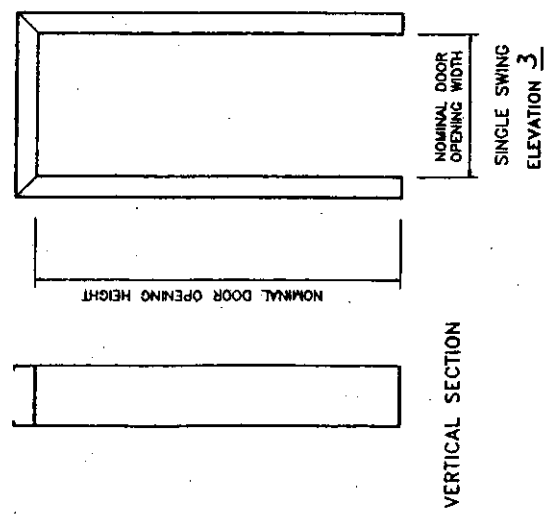

WELDED CORNERS TYPE _____

* Welded corner types with "V" prefix do not utilize corner tabs.

Series CF/O DEPTHS	
DIM B	3" THRU 9-3/4"

C.R. steel is standard.
ASTM A525 galvanized steel is optional.

	FOR HAND & SWING SEE DOOR SCHEDULE
	FOR ANCHORAGE SEE DOOR SCHEDULE & ANCHOR SHEET (DO NOT USE WS, MS, OR PFA TYPE)

SERIES/PROFILE CF/O CASED OPENING FRAMES

		Caco Door Products A United Division Company	
DRAWN BY	DATE	ISSUE DATE	BY
CHK'D BY	DATE	REVISIONS	
SHT 10 OF 27	CONTRACT NO.		

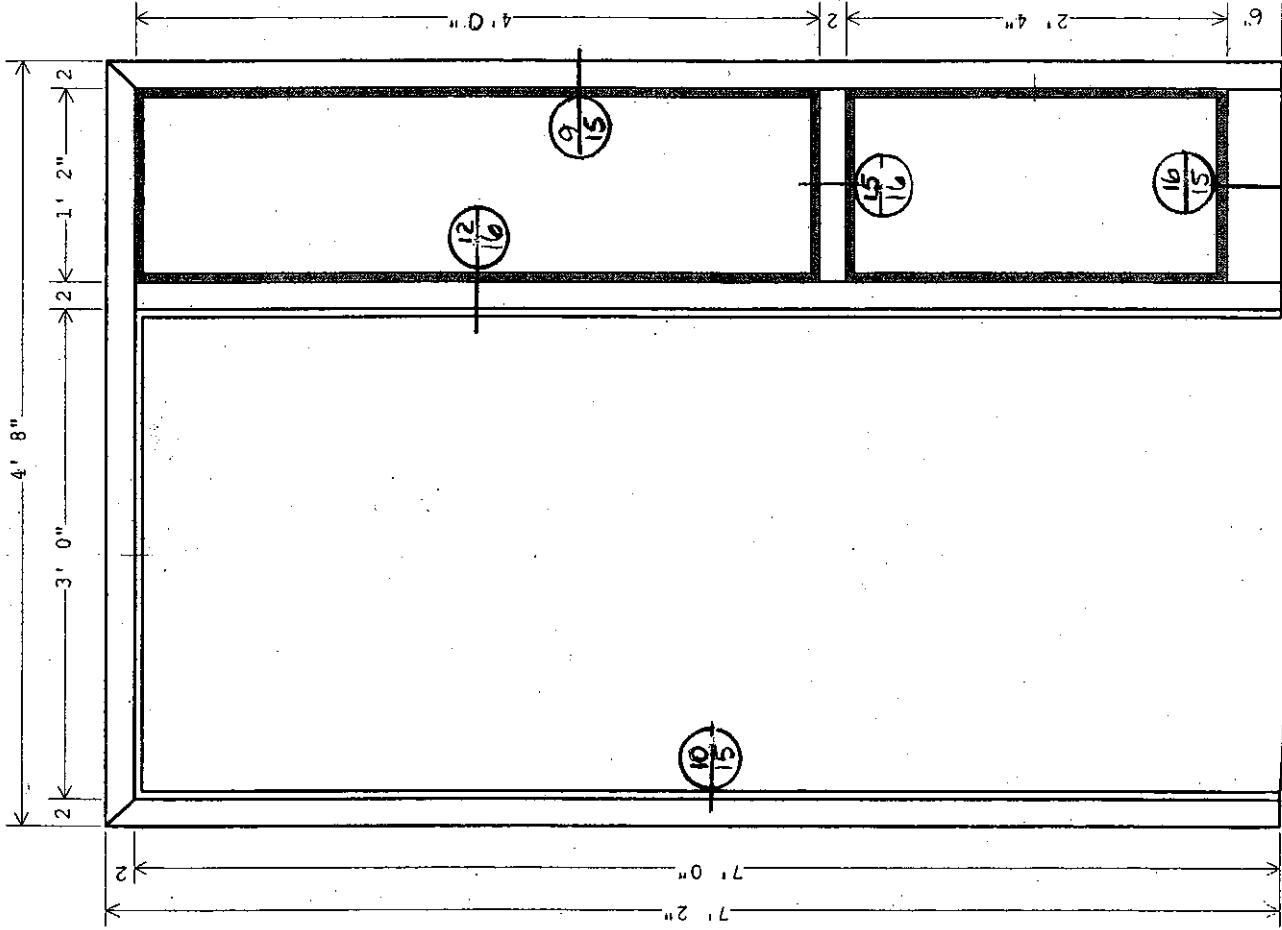

ELEV 4
19/1 (LHR)

1" Glass by Others
 CAPITOL DOOR AND HARDWARE COMPANY
 774 CORPORATE CIRCLE
 NEW CUMBERLAND, PA 17070

Project: Code: LIBRARY
 Elevation: SINGLE SIDELITE & HORIZONTAL MULLION RIGHT Code: HSL4-R
 Drawn by: cmh Date: 12/28/00 11:13 Scale: 1' 2" = 1" Page: 1

11/27

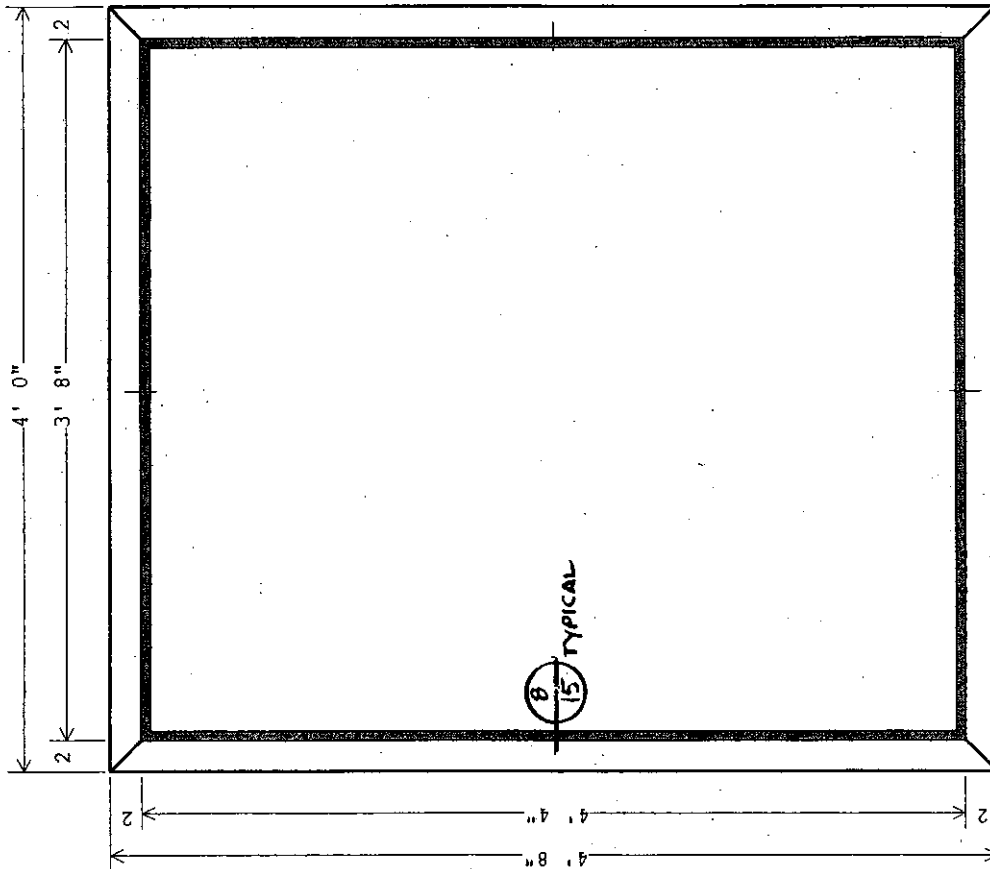

ELEV 5
HM-1, HM-2

1/4" GLASS SUPPLIED AND INSTALLED BY OTHERS

CAPITOL DOOR AND HARDWARE COMPANY
774 CORPORATE CIRCLE
NEW CUMBERLAND, PA 17070

Project: The library
Elevation: 1BL 30 x 40
Drawn by: cmh

Code: LIBRARY
Code: 1BL

Date: 12/28/00 10:45

Scale: 1' 0" = 1"

Page: 1

12/27

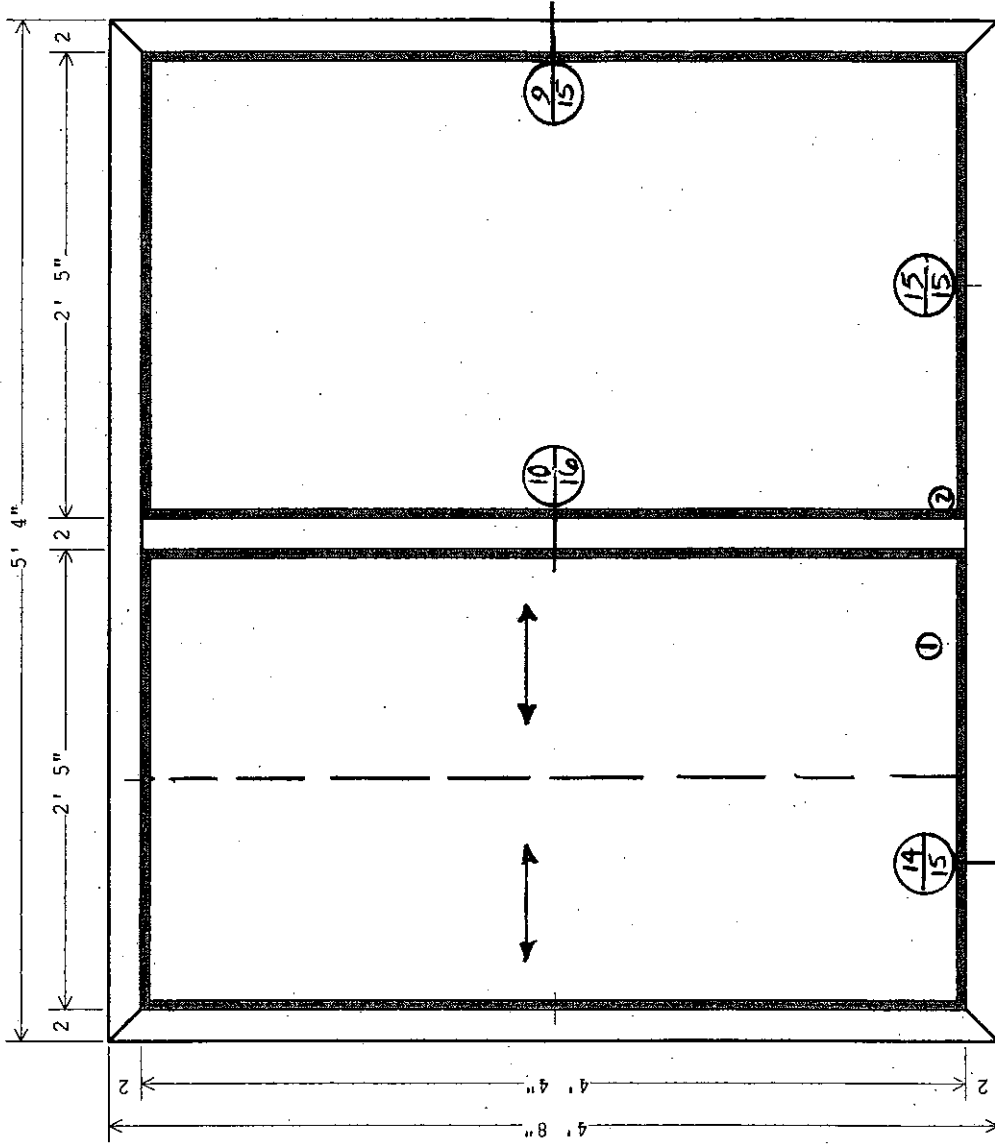

ELEV 6
HM-3

① SLIDING GLASS AND TRACK BY OTHERS (NO GLAZING BEAD)
 ② 1/4" GLASS SUPPLIED AND INSTALLED BY OTHERS

CAPITOL DOOR AND HARDWARE COMPANY
 774 CORPORATE CIRCLE
 NEW CUMBERLAND, PA 17070

Project: The library
 Elevation: 2BL 80 x 40
 Drawn by: cmh

Code: LIBRARY
 Code: 2BL

Page: 1

Scale: 1" 0" = 1"

Date: 12/28/00 10:48

13/27

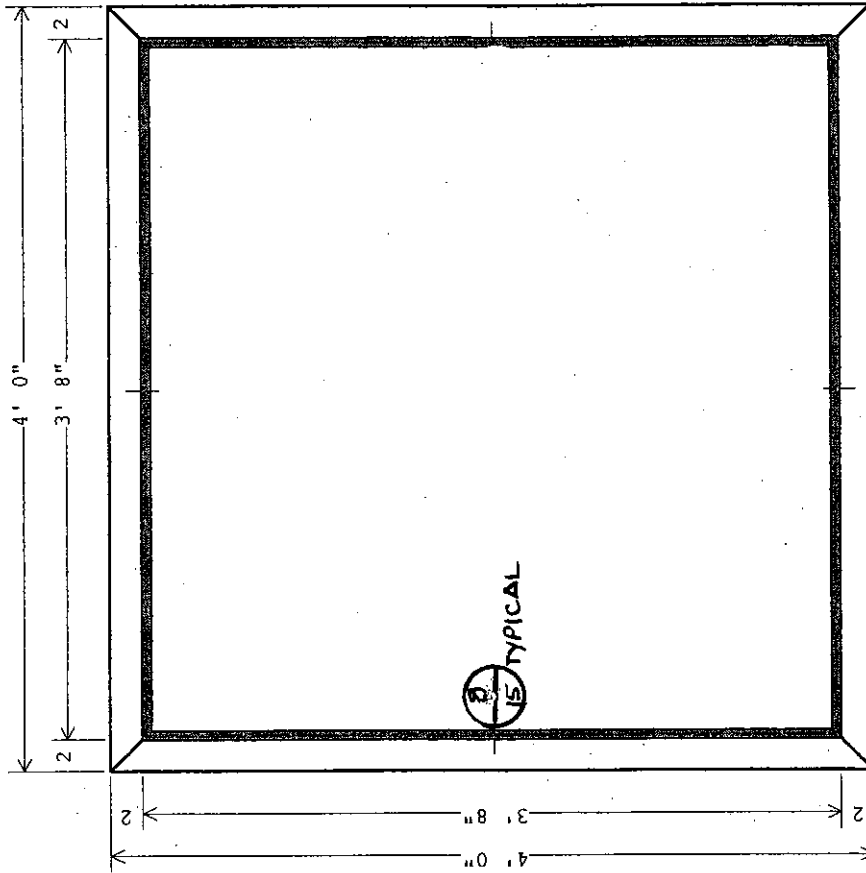

ELEV 7
HM-4

1/4" GLASS SUPPLIED & INSTALLED BY OTHERS

CAPITOL DOOR AND HARDWARE COMPANY
774 CORPORATE CIRCLE
NEW CUMBERLAND, PA 17070

Project: The library
Elevation: 1BL 30 x 40
Drawn by: cmh

Code: LIBRARY
Code: 1BL
Scale: 1' 0" = 1"

Date: 12/28/00 10:49

Page: 1

14/27

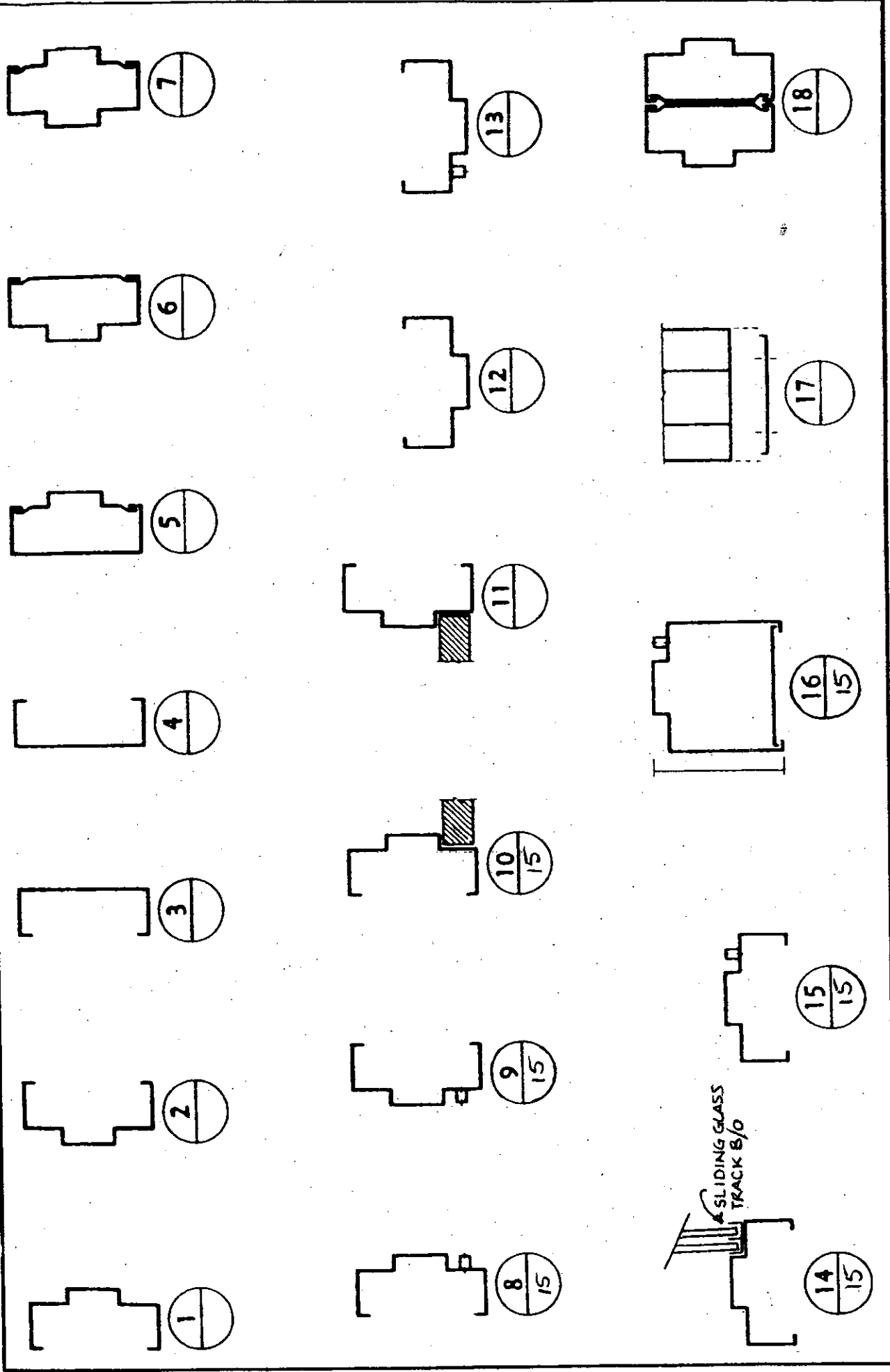

PROJECT	DATE	DRAWN BY
	REVISION	SHEET 15 OF 27

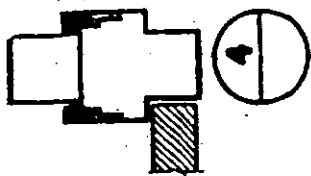

4

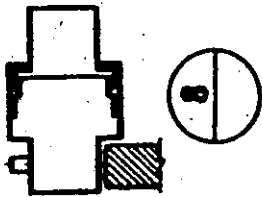

8

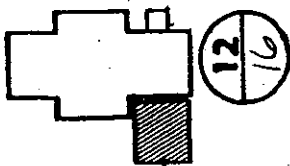

12/16

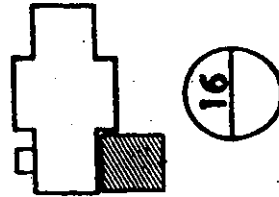

16

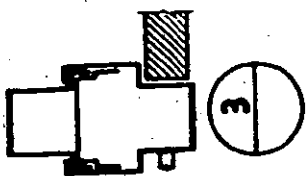

3

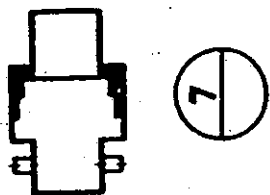

7

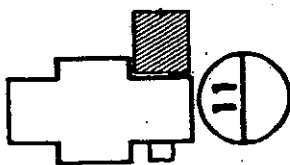

11

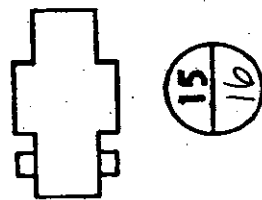

15/16

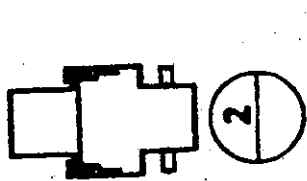

2

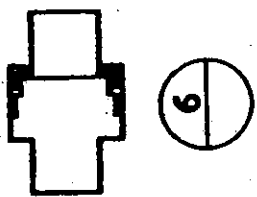

6



SLIDING GLASS
B/O

10/16

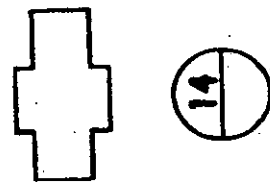

14

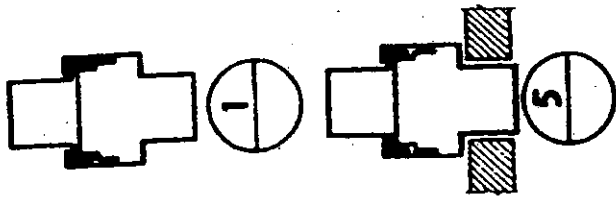

1

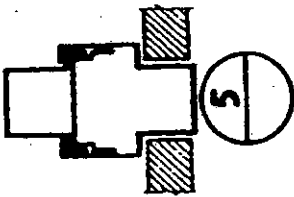

5





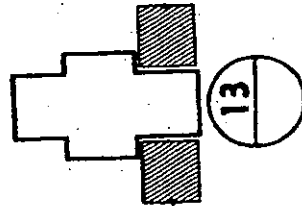

9

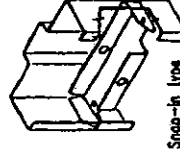
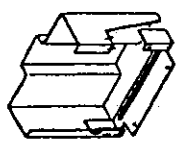
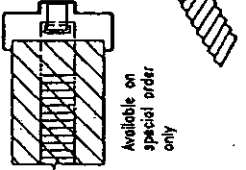
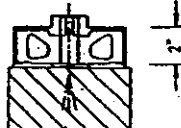
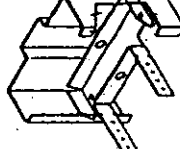
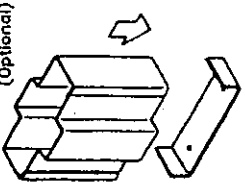
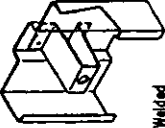
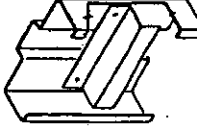
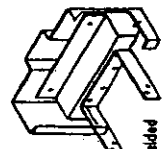

13

PROJECT	DATE	DRAWN BY
	REVISION	SHEET 16 OF 27

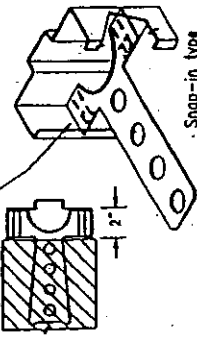
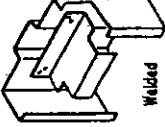
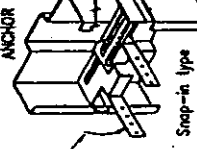
JAMB ANCHORS		FLOOR ANCHORS	
<p>WMA SERIES SF AND CF STANDARD ANCHOR</p>  <p>WIRE MASONRY ANCHOR (For 2" thru 8-3/4" depths)</p> <p>Available on special order only</p>	<p>MT FOR SPECIAL DEPTHS AND OVERSIZE FRAMES</p>  <p>Available on special order only</p> <p>2"</p> <p>3"</p> <p>4"</p> <p>5"</p> <p>6"</p> <p>7"</p> <p>8"</p> <p>9"</p> <p>10"</p> <p>11"</p> <p>12"</p> <p>13"</p> <p>14"</p> <p>15"</p> <p>16"</p> <p>17"</p> <p>18"</p> <p>19"</p> <p>20"</p> <p>21"</p> <p>22"</p> <p>23"</p> <p>24"</p> <p>25"</p> <p>26"</p> <p>27"</p> <p>28"</p> <p>29"</p> <p>30"</p> <p>31"</p> <p>32"</p> <p>33"</p> <p>34"</p> <p>35"</p> <p>36"</p> <p>37"</p> <p>38"</p> <p>39"</p> <p>40"</p> <p>41"</p> <p>42"</p> <p>43"</p> <p>44"</p> <p>45"</p> <p>46"</p> <p>47"</p> <p>48"</p> <p>49"</p> <p>50"</p> <p>51"</p> <p>52"</p> <p>53"</p> <p>54"</p> <p>55"</p> <p>56"</p> <p>57"</p> <p>58"</p> <p>59"</p> <p>60"</p> <p>61"</p> <p>62"</p> <p>63"</p> <p>64"</p> <p>65"</p> <p>66"</p> <p>67"</p> <p>68"</p> <p>69"</p> <p>70"</p> <p>71"</p> <p>72"</p> <p>73"</p> <p>74"</p> <p>75"</p> <p>76"</p> <p>77"</p> <p>78"</p> <p>79"</p> <p>80"</p> <p>81"</p> <p>82"</p> <p>83"</p> <p>84"</p> <p>85"</p> <p>86"</p> <p>87"</p> <p>88"</p> <p>89"</p> <p>90"</p> <p>91"</p> <p>92"</p> <p>93"</p> <p>94"</p> <p>95"</p> <p>96"</p> <p>97"</p> <p>98"</p> <p>99"</p> <p>100"</p>	<p>MS SERIES SF 4-3/4" and 5-3/4" DEPTH ONLY</p>  <p>Pocket provided for 1/2" or 5/8" thick wall board</p> <p>Flush with stud</p> <p>2"</p> <p>3"</p> <p>4"</p> <p>5"</p> <p>6"</p> <p>7"</p> <p>8"</p> <p>9"</p> <p>10"</p> <p>11"</p> <p>12"</p> <p>13"</p> <p>14"</p> <p>15"</p> <p>16"</p> <p>17"</p> <p>18"</p> <p>19"</p> <p>20"</p> <p>21"</p> <p>22"</p> <p>23"</p> <p>24"</p> <p>25"</p> <p>26"</p> <p>27"</p> <p>28"</p> <p>29"</p> <p>30"</p> <p>31"</p> <p>32"</p> <p>33"</p> <p>34"</p> <p>35"</p> <p>36"</p> <p>37"</p> <p>38"</p> <p>39"</p> <p>40"</p> <p>41"</p> <p>42"</p> <p>43"</p> <p>44"</p> <p>45"</p> <p>46"</p> <p>47"</p> <p>48"</p> <p>49"</p> <p>50"</p> <p>51"</p> <p>52"</p> <p>53"</p> <p>54"</p> <p>55"</p> <p>56"</p> <p>57"</p> <p>58"</p> <p>59"</p> <p>60"</p> <p>61"</p> <p>62"</p> <p>63"</p> <p>64"</p> <p>65"</p> <p>66"</p> <p>67"</p> <p>68"</p> <p>69"</p> <p>70"</p> <p>71"</p> <p>72"</p> <p>73"</p> <p>74"</p> <p>75"</p> <p>76"</p> <p>77"</p> <p>78"</p> <p>79"</p> <p>80"</p> <p>81"</p> <p>82"</p> <p>83"</p> <p>84"</p> <p>85"</p> <p>86"</p> <p>87"</p> <p>88"</p> <p>89"</p> <p>90"</p> <p>91"</p> <p>92"</p> <p>93"</p> <p>94"</p> <p>95"</p> <p>96"</p> <p>97"</p> <p>98"</p> <p>99"</p> <p>100"</p>	<p>FFA SERIES SF STANDARD ANCHOR</p>  <p>Anchor is attached to frame in the field by means of SMS</p>
<p>YS</p>  <p>YOKE AND STRAP MASONRY ANCHOR</p> <p>Welded</p>	<p>EO SERIES SF AND CF STANDARD ANCHOR</p>  <p>2"</p> <p>3"</p> <p>4"</p> <p>5"</p> <p>6"</p> <p>7"</p> <p>8"</p> <p>9"</p> <p>10"</p> <p>11"</p> <p>12"</p> <p>13"</p> <p>14"</p> <p>15"</p> <p>16"</p> <p>17"</p> <p>18"</p> <p>19"</p> <p>20"</p> <p>21"</p> <p>22"</p> <p>23"</p> <p>24"</p> <p>25"</p> <p>26"</p> <p>27"</p> <p>28"</p> <p>29"</p> <p>30"</p> <p>31"</p> <p>32"</p> <p>33"</p> <p>34"</p> <p>35"</p> <p>36"</p> <p>37"</p> <p>38"</p> <p>39"</p> <p>40"</p> <p>41"</p> <p>42"</p> <p>43"</p> <p>44"</p> <p>45"</p> <p>46"</p> <p>47"</p> <p>48"</p> <p>49"</p> <p>50"</p> <p>51"</p> <p>52"</p> <p>53"</p> <p>54"</p> <p>55"</p> <p>56"</p> <p>57"</p> <p>58"</p> <p>59"</p> <p>60"</p> <p>61"</p> <p>62"</p> <p>63"</p> <p>64"</p> <p>65"</p> <p>66"</p> <p>67"</p> <p>68"</p> <p>69"</p> <p>70"</p> <p>71"</p> <p>72"</p> <p>73"</p> <p>74"</p> <p>75"</p> <p>76"</p> <p>77"</p> <p>78"</p> <p>79"</p> <p>80"</p> <p>81"</p> <p>82"</p> <p>83"</p> <p>84"</p> <p>85"</p> <p>86"</p> <p>87"</p> <p>88"</p> <p>89"</p> <p>90"</p> <p>91"</p> <p>92"</p> <p>93"</p> <p>94"</p> <p>95"</p> <p>96"</p> <p>97"</p> <p>98"</p> <p>99"</p> <p>100"</p>	<p>WS SERIES SF STANDARD ANCHOR</p>  <p>Pocket provided for 1/2" or 5/8" thick wall board</p> <p>Flush with stud</p> <p>2"</p> <p>3"</p> <p>4"</p> <p>5"</p> <p>6"</p> <p>7"</p> <p>8"</p> <p>9"</p> <p>10"</p> <p>11"</p> <p>12"</p> <p>13"</p> <p>14"</p> <p>15"</p> <p>16"</p> <p>17"</p> <p>18"</p> <p>19"</p> <p>20"</p> <p>21"</p> <p>22"</p> <p>23"</p> <p>24"</p> <p>25"</p> <p>26"</p> <p>27"</p> <p>28"</p> <p>29"</p> <p>30"</p> <p>31"</p> <p>32"</p> <p>33"</p> <p>34"</p> <p>35"</p> <p>36"</p> <p>37"</p> <p>38"</p> <p>39"</p> <p>40"</p> <p>41"</p> <p>42"</p> <p>43"</p> <p>44"</p> <p>45"</p> <p>46"</p> <p>47"</p> <p>48"</p> <p>49"</p> <p>50"</p> <p>51"</p> <p>52"</p> <p>53"</p> <p>54"</p> <p>55"</p> <p>56"</p> <p>57"</p> <p>58"</p> <p>59"</p> <p>60"</p> <p>61"</p> <p>62"</p> <p>63"</p> <p>64"</p> <p>65"</p> <p>66"</p> <p>67"</p> <p>68"</p> <p>69"</p> <p>70"</p> <p>71"</p> <p>72"</p> <p>73"</p> <p>74"</p> <p>75"</p> <p>76"</p> <p>77"</p> <p>78"</p> <p>79"</p> <p>80"</p> <p>81"</p> <p>82"</p> <p>83"</p> <p>84"</p> <p>85"</p> <p>86"</p> <p>87"</p> <p>88"</p> <p>89"</p> <p>90"</p> <p>91"</p> <p>92"</p> <p>93"</p> <p>94"</p> <p>95"</p> <p>96"</p> <p>97"</p> <p>98"</p> <p>99"</p> <p>100"</p>	<p>SLFA (Optional)</p>  <p>IN-FIELD: FASTEN ANCHOR TO FLOOR. SLIP-FIT OVER FRAME ANCHOR</p>
<p>EO/N (Optional)</p>  <p>Welded</p> <p>Used where standard anchor is not applicable</p>	<p>MSZ1 (Optional)</p>  <p>5/8"</p> <p>Welded</p>	<p>WSZS (Optional)</p>  <p>Welded</p> <p>5/8"</p> <p>DESIGNATE WALL CONFIGURATION SO THAT PROPER POCKET CAN BE PROVIDED</p>	<p>SFA (Optional)</p>  <p>Welded</p> <p>ANCHOR MAY BE CONTINUOUS OR TWO PIECE AS SHOWN.</p>
<p>MT 4-3/4" and 5-3/4" DEPTHS</p>  <p>3"</p> <p>4"</p> <p>5"</p> <p>6"</p> <p>7"</p> <p>8"</p> <p>9"</p> <p>10"</p> <p>11"</p> <p>12"</p> <p>13"</p> <p>14"</p> <p>15"</p> <p>16"</p> <p>17"</p> <p>18"</p> <p>19"</p> <p>20"</p> <p>21"</p> <p>22"</p> <p>23"</p> <p>24"</p> <p>25"</p> <p>26"</p> <p>27"</p> <p>28"</p> <p>29"</p> <p>30"</p> <p>31"</p> <p>32"</p> <p>33"</p> <p>34"</p> <p>35"</p> <p>36"</p> <p>37"</p> <p>38"</p> <p>39"</p> <p>40"</p> <p>41"</p> <p>42"</p> <p>43"</p> <p>44"</p> <p>45"</p> <p>46"</p> <p>47"</p> <p>48"</p> <p>49"</p> <p>50"</p> <p>51"</p> <p>52"</p> <p>53"</p> <p>54"</p> <p>55"</p> <p>56"</p> <p>57"</p> <p>58"</p> <p>59"</p> <p>60"</p> <p>61"</p> <p>62"</p> <p>63"</p> <p>64"</p> <p>65"</p> <p>66"</p> <p>67"</p> <p>68"</p> <p>69"</p> <p>70"</p> <p>71"</p> <p>72"</p> <p>73"</p> <p>74"</p> <p>75"</p> <p>76"</p> <p>77"</p> <p>78"</p> <p>79"</p> <p>80"</p> <p>81"</p> <p>82"</p> <p>83"</p> <p>84"</p> <p>85"</p> <p>86"</p> <p>87"</p> <p>88"</p> <p>89"</p> <p>90"</p> <p>91"</p> <p>92"</p> <p>93"</p> <p>94"</p> <p>95"</p> <p>96"</p> <p>97"</p> <p>98"</p> <p>99"</p> <p>100"</p>	<p>MSZ2 (Optional)</p>  <p>Welded</p> <p>DESIGNATE WALL CONFIGURATION SO THAT PROPER POCKET CAN BE PROVIDED</p> <p>Flush with stud</p>	<p>ADJ/STUD SPECIAL DEPTH STANDARD ANCHOR</p>  <p>3/4"</p> <p>2"</p> <p>3"</p> <p>4"</p> <p>5"</p> <p>6"</p> <p>7"</p> <p>8"</p> <p>9"</p> <p>10"</p> <p>11"</p> <p>12"</p> <p>13"</p> <p>14"</p> <p>15"</p> <p>16"</p> <p>17"</p> <p>18"</p> <p>19"</p> <p>20"</p> <p>21"</p> <p>22"</p> <p>23"</p> <p>24"</p> <p>25"</p> <p>26"</p> <p>27"</p> <p>28"</p> <p>29"</p> <p>30"</p> <p>31"</p> <p>32"</p> <p>33"</p> <p>34"</p> <p>35"</p> <p>36"</p> <p>37"</p> <p>38"</p> <p>39"</p> <p>40"</p> <p>41"</p> <p>42"</p> <p>43"</p> <p>44"</p> <p>45"</p> <p>46"</p> <p>47"</p> <p>48"</p> <p>49"</p> <p>50"</p> <p>51"</p> <p>52"</p> <p>53"</p> <p>54"</p> <p>55"</p> <p>56"</p> <p>57"</p> <p>58"</p> <p>59"</p> <p>60"</p> <p>61"</p> <p>62"</p> <p>63"</p> <p>64"</p> <p>65"</p> <p>66"</p> <p>67"</p> <p>68"</p> <p>69"</p> <p>70"</p> <p>71"</p> <p>72"</p> <p>73"</p> <p>74"</p> <p>75"</p> <p>76"</p> <p>77"</p> <p>78"</p> <p>79"</p> <p>80"</p> <p>81"</p> <p>82"</p> <p>83"</p> <p>84"</p> <p>85"</p> <p>86"</p> <p>87"</p> <p>88"</p> <p>89"</p> <p>90"</p> <p>91"</p> <p>92"</p> <p>93"</p> <p>94"</p> <p>95"</p> <p>96"</p> <p>97"</p> <p>98"</p> <p>99"</p> <p>100"</p>	<p>SPECIAL SIZE FLOOR ANCHOR</p>

Series SF and CF FRAME ANCHORS

3 PER JAMB FOR HEIGHTS UP TO 7'-2" AND ONE FLOOR ANCHOR
 4 PER JAMB FOR HEIGHTS FROM 7'-3" THRU 9'-0" AND ONE FLOOR ANCHOR
 ONE ADDITIONAL JAMB ANCHOR FOR EACH ADDITIONAL TWO FEET IN HEIGHT OR FRACTION THEREOF
 ONE ADDITIONAL JAMB ANCHOR IN LIEU OF FLOOR ANCHOR FOR EO AND WS TYPE CONDITIONS

ANCHOR QUANTITIES	REVISIONS	BY
ISSUE DATE		
CONTRACT NO.		
SHT 17 OF 22		

Ceco Door Products
 A United Distribution Company

DRAWN BY: _____ DATE: _____
 CHK'D BY: _____ DATE: _____
 SHT 17 OF 22



FRAME INSTALLATION MASONRY and STUD WALLS

JOB SITE STORAGE: Store frames off the ground on wood runners or skids. Do not store directly on the ground. Cover frames with tarpaulin or plastic but do insure that adequate ventilation is provided to eliminate moisture condensation. When frames are to be fully grouted and when plaster or mortar contain "anti-freeze" agents, the inside of the frames should be coated with a bituminous, water-resistant paint by the installation contractor.

ASSEMBLY of FRAME

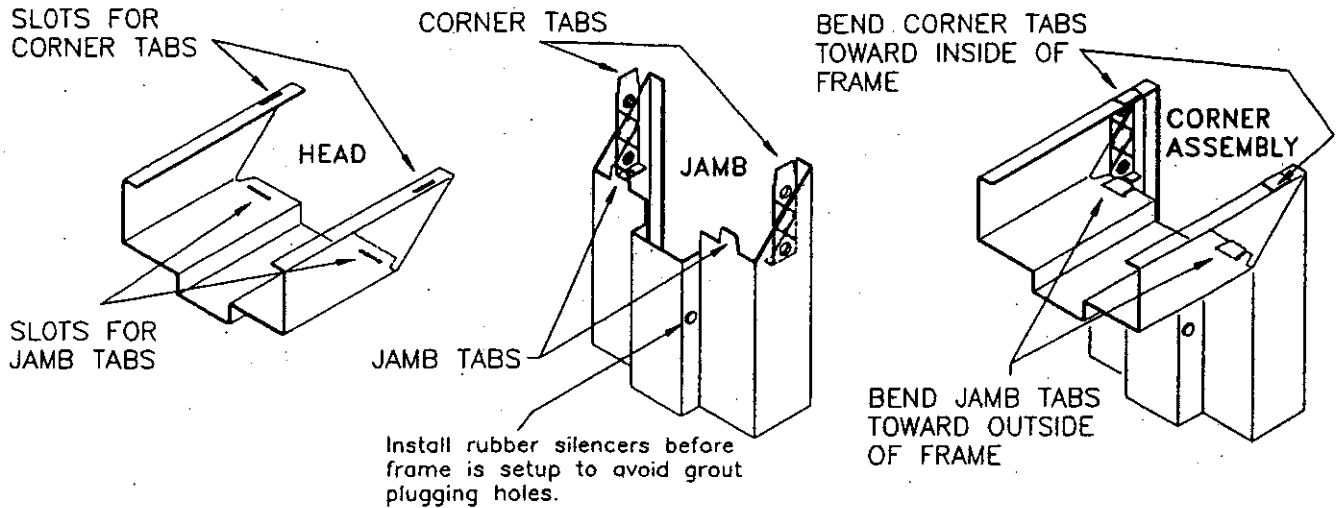

PLUMBING FRAME

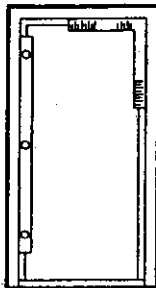

SQUARING THE FRAME

The installer should use wood spreaders (as described at right), a carpenters level (the longer the better), and a carpenters square (the bigger the better). Set the frame in the desired location. Level head and plumb jambs. Shim under jambs if necessary.

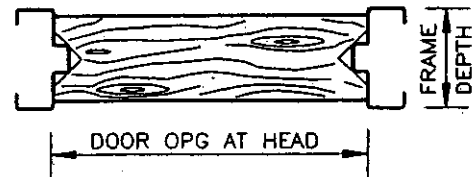

SPREADER

Typical wood spreader must be square and made from lumber at least 1" thick. Length of spreader equals door opening width at the head. Cut clearance notches for frame stops as shown. Spreader must be nearly as wide as frame depth for proper installation.

10/27

MASONRY WALL CONSTRUCTION

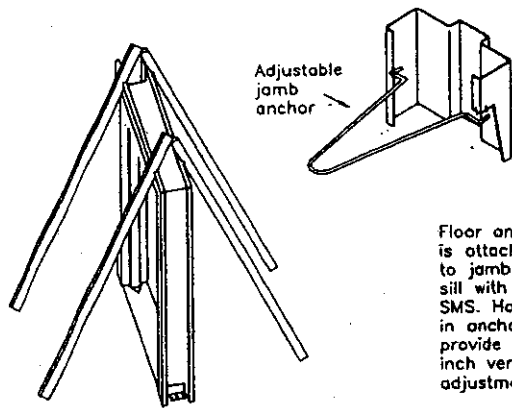

BRACING THE FRAME

NOTE: If frame is received setup and welded, remove and discard the temporary metal supports that are tack welded to jambs at sill before starting installation.

Brace the frame as shown or shore to ceiling. Do not brace in the direction of intended wall. Plumb and square jambs. Set spreader. Attach jambs to floor through floor anchor.

Floor anchor is attached to jamb at sill with (2) SMS. Holes in anchor provide one inch vertical adjustment.

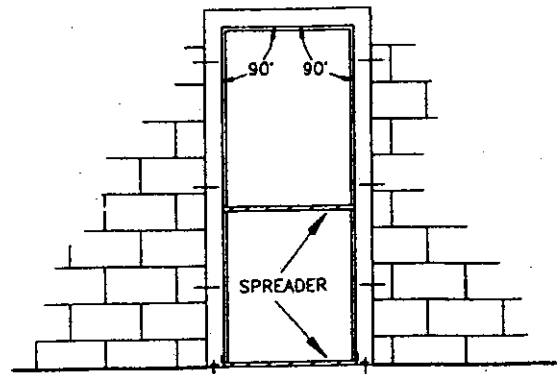
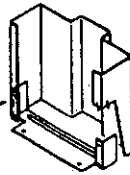

INSTALLING THE FRAME

Set and plumb frame. Install jamb anchors at hinge levels as wall is laid up. (3 anchors for heights to 7'-2" -- one more anchor per jamb for each additional 2 feet of height or fraction thereof.) Grout frame in the area of the anchors. A second spreader should be used at mid-point of opening to maintain the door opening dimension. Continually check plumb and square as wall progresses. **CHECK:** The difference between diagonals measured from opposite corners should not exceed 1/16".

WOOD or METAL STUD WALL CONSTRUCTION

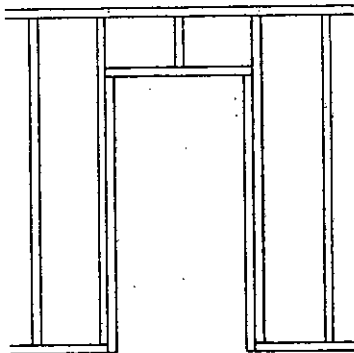

ROUGH STUD OPENING

ADD 3/8" TO OVERALL FRAME WIDTH.
ADD 1/8" TO OVERALL FRAME HEIGHT

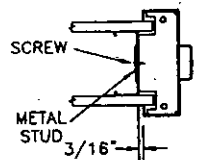

DET. A

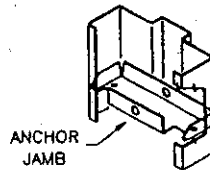

DET. B

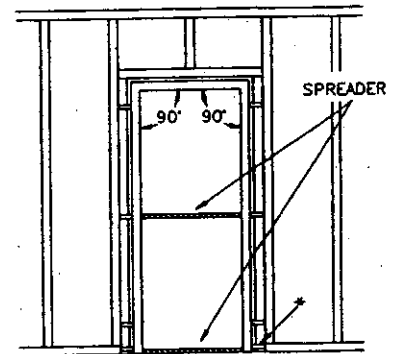

INSTALLING THE FRAME

1. Build the rough opening in wall allowing 3/16" clearance between upright stud and frame jamb and 1/8" clearance between header and top of door frame. *

2. Insert jamb anchors in frame throat and top into place with a hammer. Place at hinge location and directly opposite on strike jamb. Position anchors also at sill.

3. Place frame in rough opening.

4. Set spreader and level frame. Shim jambs if necessary.

*If you choose to erect door frame before wall framing: brace frame and anchor at sill per masonry procedure above, then butt studs to door frame.

5. Square and fasten top anchors to stud on ONE JAMB ONLY. Check plumb and square of door frame and continue to fasten balance of anchors to studs. Repeat on opposite jamb.

6A. If your anchor looks like Det. A, fasten anchor to metal stud thru web of channel using suitable fastener for sheet metal.

6B. If your anchor looks like Det. B, bend anchor tabs around stud and fasten tabs with suitable fastener.

7. Maintain necessary clearance between frame returns and stud for inserting wall board. Do not install wall board until you are sure that frame is plumb and square.

19/61



Ceco Door Products
A United Dominion Company

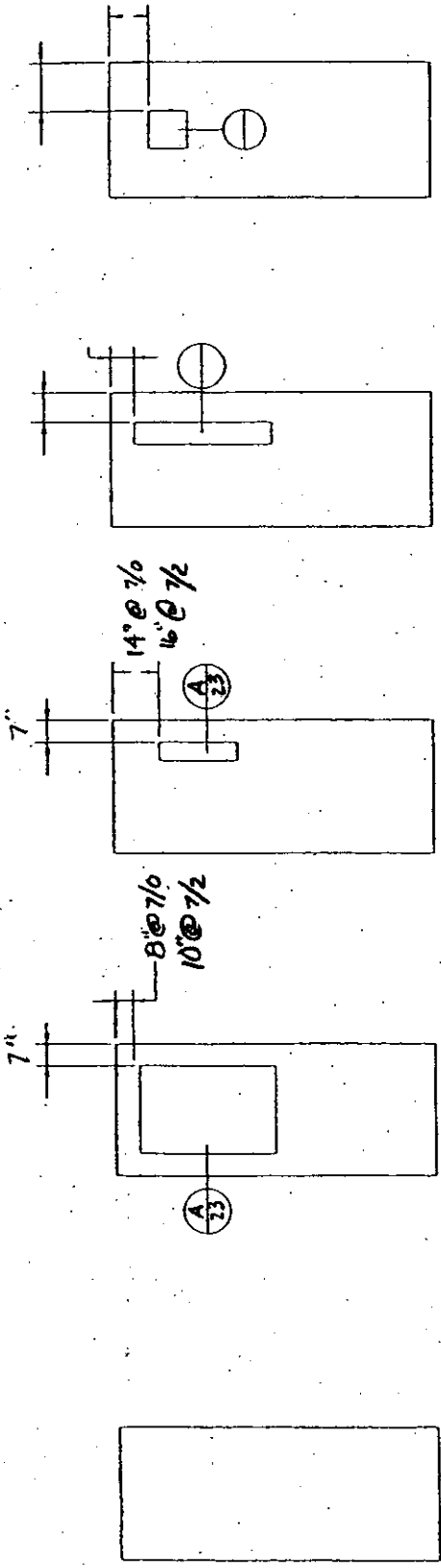

ELEV. 4 _____ ELEV. 2 _____ ELEV. 3 _____ ELEV. _____

22' x 30' LITE
5 x 20 LITE
(1/4" GLASS BY OTHERS)

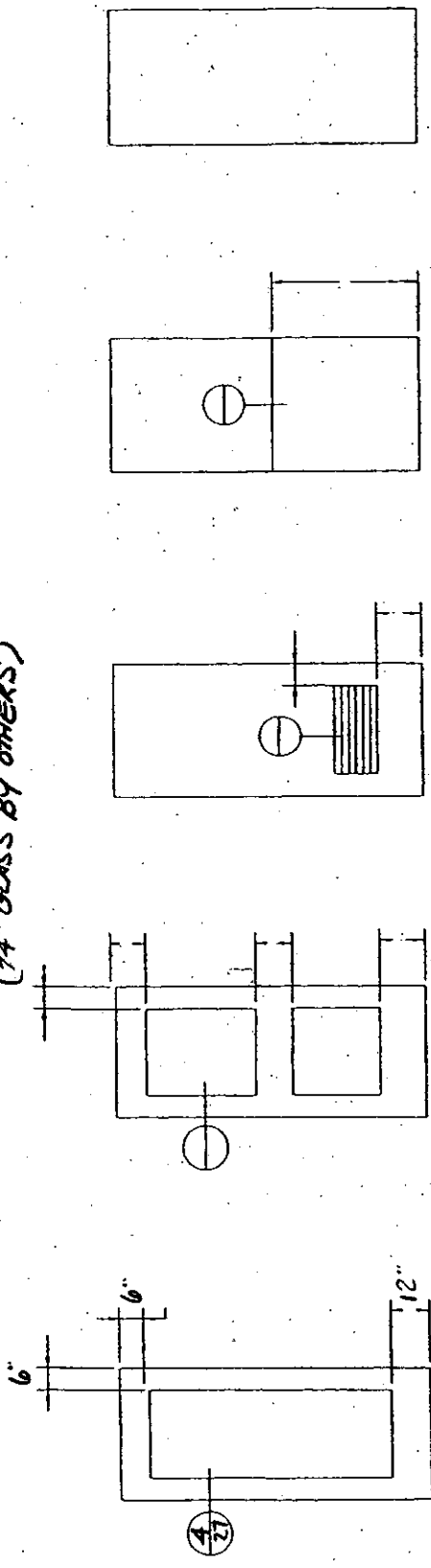

ELEV. 1 _____ ELEV. _____ ELEV. _____ ELEV. _____

1" INSULATED GLASS BY OTHERS

JOB NAME:

DRAWN BY:

DATE:

JOB #

TITLE:

SHEET # 20 OF 27

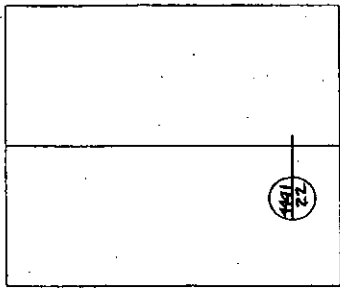

ELEV. 5

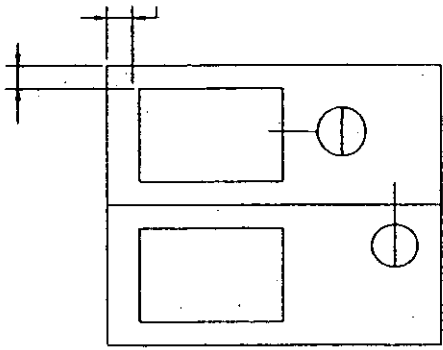

ELEV. _____

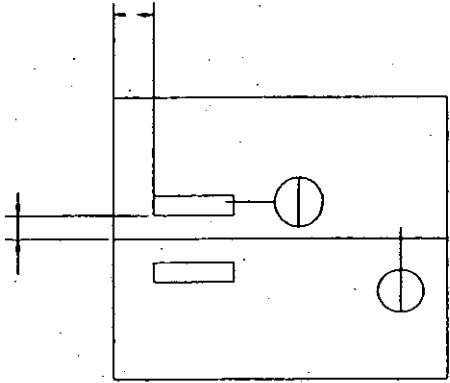

ELEV. _____

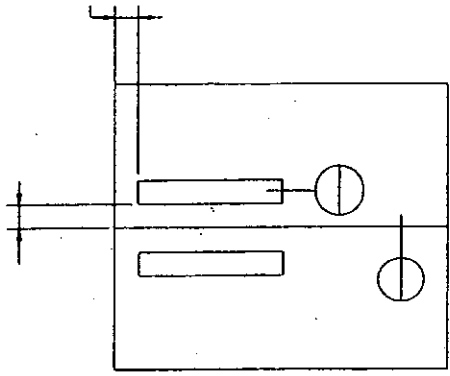

ELEV. _____

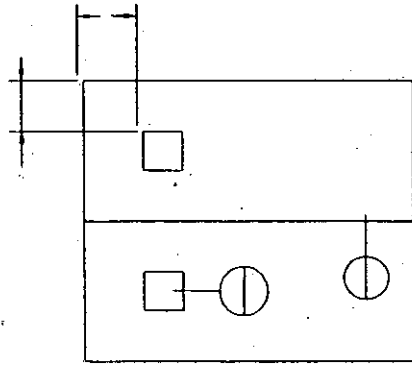

ELEV. _____

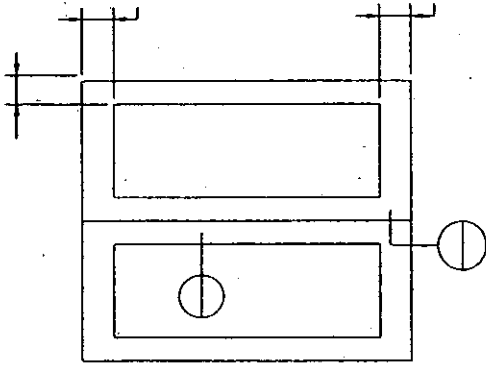

ELEV. _____

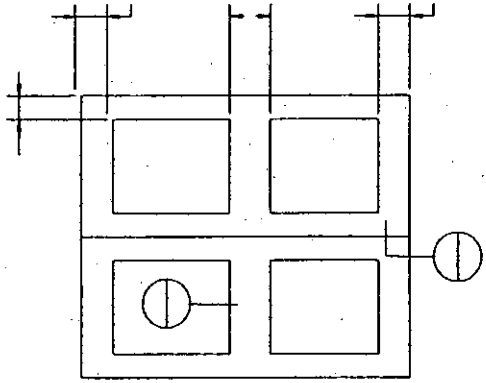

ELEV. _____

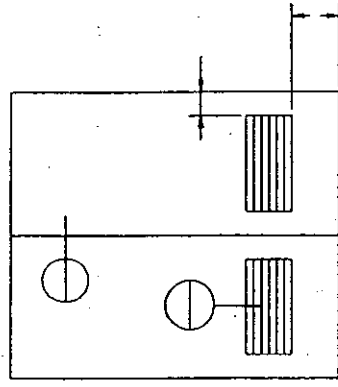

ELEV. _____

JOB NAME:

DRAWN BY:

DATE:

JOB #

TITLE:

SHEET # 21

OF 27

ASTRAGALS

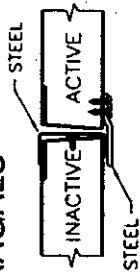

4441
 OVERLAPPING ASTRAGAL
 FOR 1-3/4" THICK DOORS

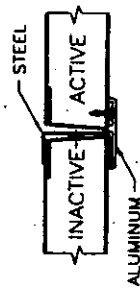

4451
 OVERLAPPING ASTRAGAL
 WITH OPTIONAL POLY-PILE INSERT



4471
 OVERLAPPING ASTRAGAL



FLAT PLATE ASTRAGAL
4491 PLAIN STEEL (welded on)
 (Medallion & Thrulite Doors only)
4481 STAINLESS STEEL (screwed on)
 (Stainless steel doors only)

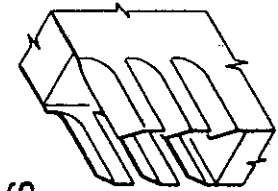

"L" DESIGN (PIERCED)
 FOR HONEYCOMB CORE DOORS

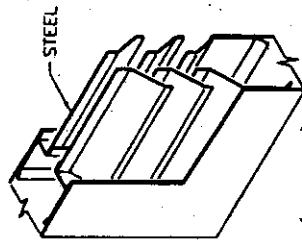

4684 (FLUSH)
 FOR MEDALLION DOORS (ONLY)

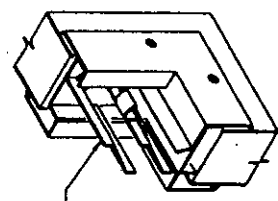

4605/FLDL (ADJUSTABLE)

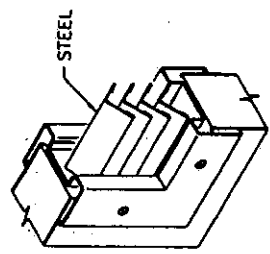

4631 (INVERTED "V")

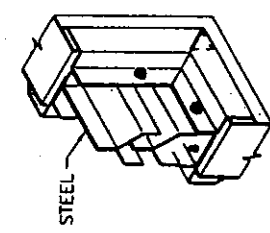

4634 (FIXED SLAT)

GLASS LITE TRIM KITS (G, V, and N)

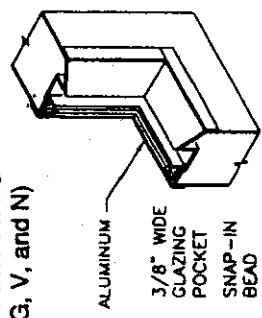

4831 (APPLIED)

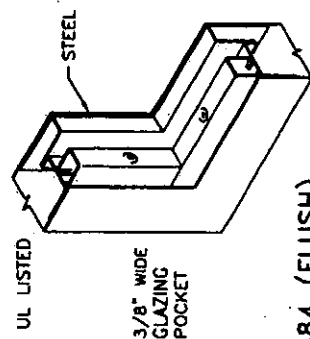

4884 (FLUSH)
 FOR MEDALLION AND THRULITE DOORS

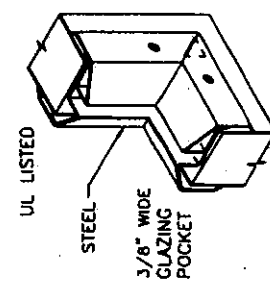

4834 (APPLIED)

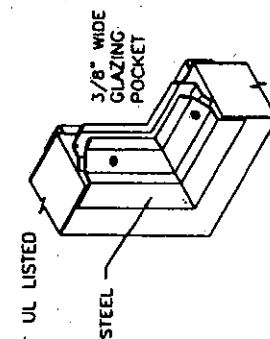

4841 (APPLIED)

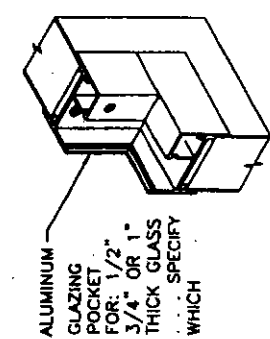

4900 (APPLIED)

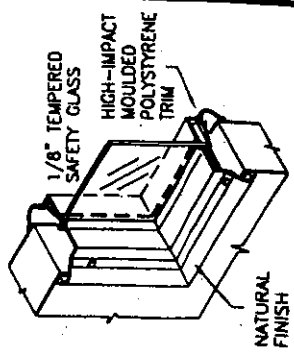

4854 (Applied)
 FOR STAINLESS STEEL DOORS (ONLY)

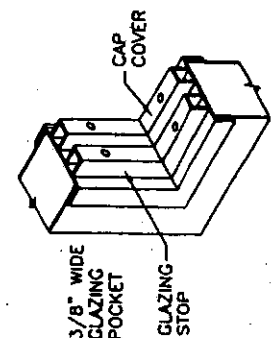

4854 (Applied)
 FOR STAINLESS STEEL DOORS (ONLY)

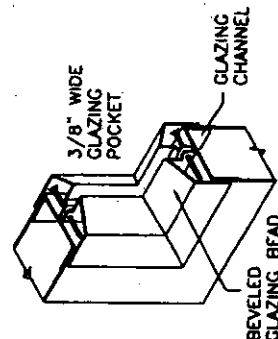

LoPro (Applied)

DOOR ACCESSORIES
 (FOR 1-3/4" DOORS)

Ceco Door Products A United Dominion Company		DATE _____	DATE _____	ISSUE DATE _____	REVISIONS _____	BY _____
DRAWN BY _____	CHK'D BY _____	CONTRACT NO. _____		ISSUE DATE _____	REVISIONS _____	BY _____
SHT 22	OF 27					

MODEL 115 FIRE DOOR LIGHT FRAMES

PATENT NO. 4,550,542

ORDER INFORMATION:

ORDER SIZE = INSIDE DIMENSION OF FRAME, as illustrated (W x H)

CUTOUT SIZE = ORDER SIZE + 1-1/2", as illustrated

GLASS SIZE = ORDER SIZE + 3/4", as illustrated

UL & WHI LISTED

Meets UL10B requirements for NEGATIVE PRESSURE and

UL10C & UBC 7-2 (1997) requirements for POSITIVE PRESSURE

For details refer to AMS Listing Specifications.

Fire Tested with NO glazing compound, tape, or intumescent.

STD SPECS: 18 GA. CRS with BEIGE PRIMER

SPECIALS:

- 18 GA. GALVANIZED
- 18 GA. STAINLESS STEEL
- SPECIAL COLORS
- VENEER WRAPPED

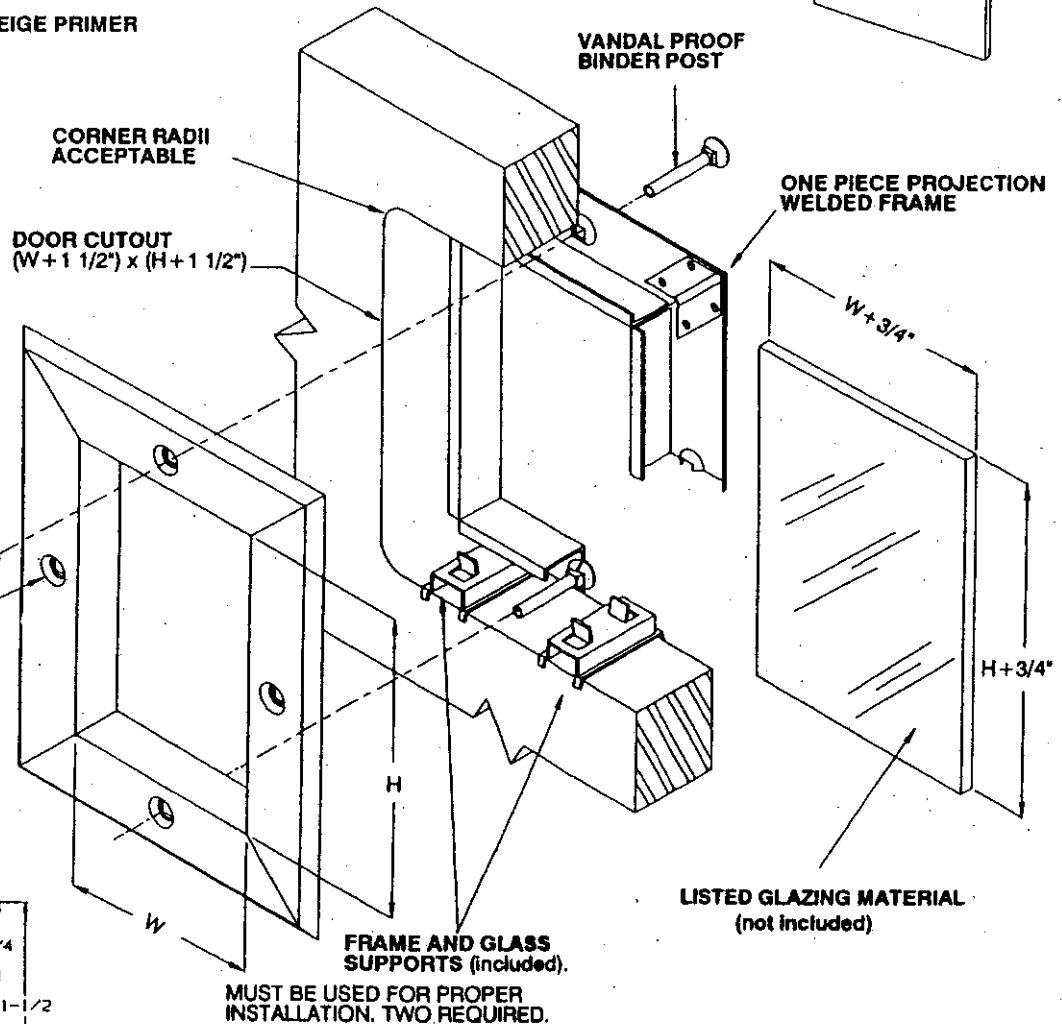
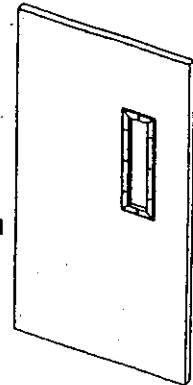

PHILLIPS DRIVE #8-32
FLAT HEAD SCREW
INSTALL ON SECURED
SIDE OF DOOR

MOUNTING HOLES
11" LENGTH OR LESS:
1 HOLE CENTERED
OVER 11":
3" MAX. FROM CORNERS,
11-5/16" MAX. CENTERS

LISTED GLAZING MATERIAL
(not included)

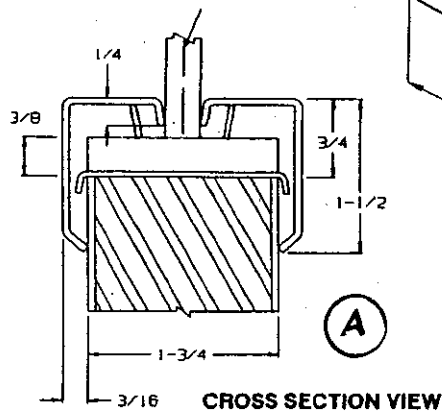

**Laminated Glass
NOT Recommended
See Glass Note below.**

GLASS NOTE: For non-fire door applications we recommend 1/4" tempered glass. If laminated glass is used, thin glazing and light torque on screws is required to prevent glass breakage.

Phone (715) 223-6324

ALL METAL STAMPING, INC.
411 W. Spruce St., Abbotsford, Wisconsin 54405

FAX (715) 223-3352

23/27

$$\underline{\underline{(A = B + C)}}$$

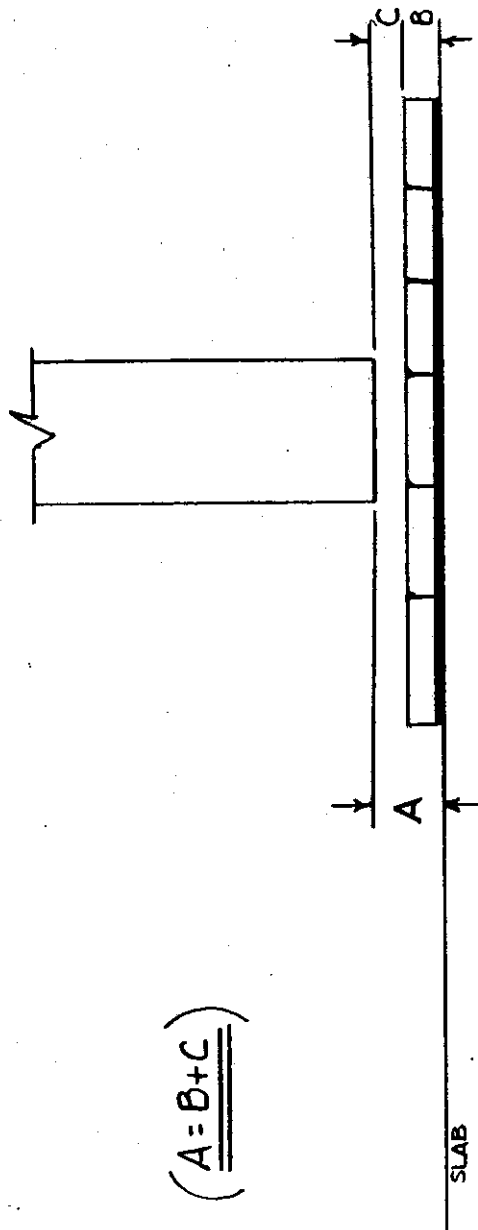

- A. UNDERCUT = DISTANCE FROM BOTTOM OF DOOR TO BOTTOM OF FRAME
- B. FLOOR COVERING TREATMENT = VARIES
- C. CLEARANCE = 1/4" (STANDARD)

PROJECT 1	DATE	DRAWN BY
	REVISIONS	SHEET 24 OF 27

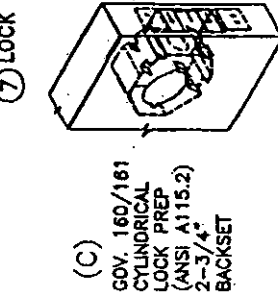
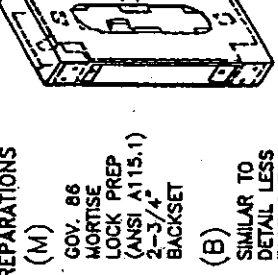
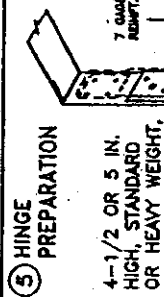
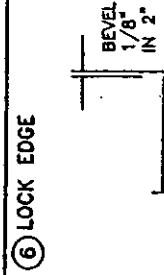
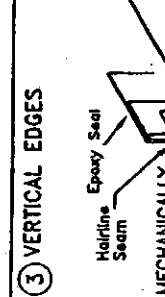
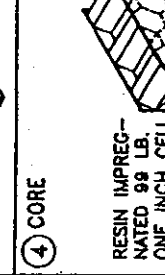
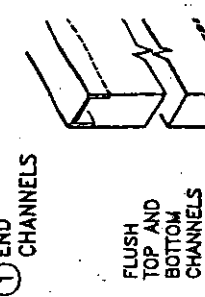
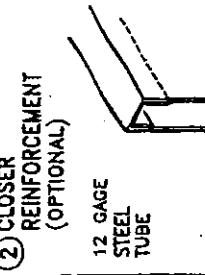

U FACTOR: 0.41
R FACTOR: 2.44

SOUND TRANSMISSION CLASS (STC): 32 F DESIGN, 18 GAGE FACE SHEETS - - ASTM E90-81 & E413-73 (FULLY OPERABLE)

MEETS OR EXCEEDS ANSI A 151.1 PERFORMANCE TEST:
20 gage steel (500,000 cycles); 18 & 16 gage steel (1,000,000 cycles).

CORE THERMAL INSULATION
SOUND TRANSMISSION
PHYSICAL ENDURANCE TEST DATA

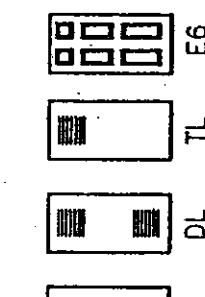

12" x 14-1/2" PIERCED LOUVER

"N" NARROW LITE SIZES ARE AVAILABLE IN 6" AND 8" WIDTHS AND IN 36" TO 60" HEIGHTS, IN 4" INCREMENTS.

EIRE DOORS:
TEST: UL10B, UL10C
UBC 7-2

LABELING AGENCIES:
UNDERWRITERS LABORATORY, INC.
WARNOCK HERSEY INTL
FACTORY MUTUAL SYSTEM

RATING: 20 MIN THRU 3 HR
MAX. SIZE: 40 x 90 SINGLE
80 x 90 PAIR
DESIGNS: F, G, N, & V

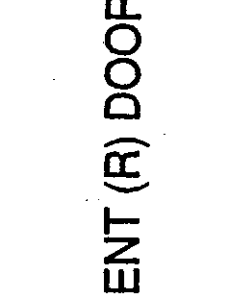
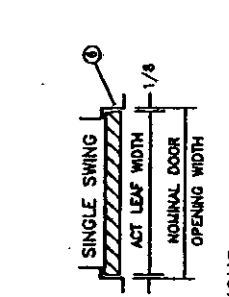
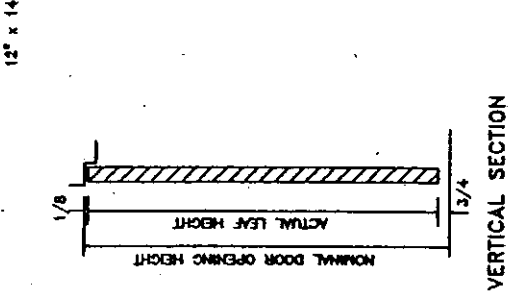

1-3/4" REGENT (R) DOOR

Caco Door Products
A United Dominion Company

DRAWN BY _____ DATE _____
CHK'D BY _____ DATE _____

CONTRACT NO. _____
SHT 25 OF 27
ISSUE DATE _____
REVISIONS BY _____

Full Mortise Hinges

Plain Bearing • Standard Weight • Template
 For use on Medium Weight Doors Requiring Low Frequency Service
 (Not for use with Door Closer)

1279

Steel with steel pin ANSI A8133

1191

Brass with brass pin ANSI A2133

Stainless Steel with stainless steel pin ANSI A5133

Five knuckle non-rising removable pin with button tip and plug.
 Specify screw requirements.

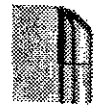
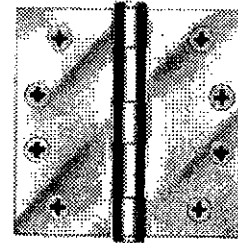

For Hospital type
 prefix "HT" to
 catalog number.

Hinge Size		Gauge of metal	Number of holes	Screw Size		Quantity		Avg weight per case (lbs)	
Inches	Millimeters			Machine	Wood	Box	Case	Steel	SSteel/Brass
2 x 2	51 x 51	0.083	4	1/2 x 8-32	3/4 x 8	10 each	200 each	32	35
2 1/2 x 2 1/2	64 x 64	0.089	6	1/2 x 8-32	3/4 x 8	10 each	200 each	34	39
3 x 3	76 x 76	0.097	6	1/2 x 10-24	1 x 9	2 each	100 each	37	40
3 1/2 x 3 1/2	89 x 89	0.119	6	1/2 x 10-24	1 x 9	2 each	100 each	66	72
4 x 4	102 x 102	0.129	8	1/2 x 12-24	1 1/4 x 12	3 each	48 each	43	47
4 1/2 x 4	114 x 102	0.134	8	1/2 x 12-24	1 1/4 x 12	3 each	48 each	49	53
4 1/2 x 4 1/2	114 x 114	0.134	8	1/2 x 12-24	1 1/4 x 12	3 each	48 each	55	60
5 x 4	127 x 102	0.145	8	1/2 x 12-24	1 1/4 x 12	3 each	24 each	37	40
5 x 4 1/2	127 x 114	0.145	8	1/2 x 12-24	1 1/4 x 12	3 each	24 each	37	40
5 x 5	127 x 127	0.145	8	1/2 x 12-24	1 1/4 x 12	3 each	24 each	37	40
6 x 4 1/2	152 x 114	0.160	10	1/2 x 1/4 -20	1 1/2 x 14	3 each	24 each	61	66
6 x 5	152 x 127	0.160	10	1/2 x 1/4 -20	1 1/2 x 14	3 each	24 each	61	66
6 x 6	152 x 152	0.160	10	1/2 x 1/4 -20	1 1/2 x 14	3 each	24 each	61	66

Ball Bearing • Standard Weight • Template

For use on Medium Weight Doors or Doors Requiring Medium Frequency Service

BB1279

Steel with steel pin ANSI A8112

BB1191

Brass with brass pin ANSI A2112

Stainless Steel with stainless steel pin ANSI A5112

Five knuckle two ball bearings non-rising removable pin with button tip and plug.
 Specify screw requirements.

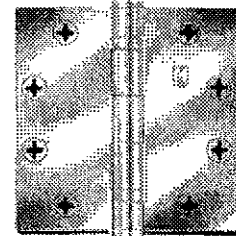

For Hospital type
 prefix "HT" to
 catalog number.

Hinge Size		Gauge of metal	Number of holes	Screw Size		Quantity		Avg weight per case (lbs)	
Inches	Millimeters			Machine	Wood	Box	Case	Steel	SSteel/Brass
3 1/2 x 3 1/2	89 x 89	0.119	6	1/2 x 10-24	1 x 9	2 each	100 each	66	72
4 x 4	102 x 102	0.129	8	1/2 x 12-24	1 1/4 x 12	3 each	48 each	43	47
4 1/2 x 4	114 x 102	0.134	8	1/2 x 12-24	1 1/4 x 12	3 each	48 each	55	60
4 1/2 x 4 1/2	114 x 114	0.134	8	1/2 x 12-24	1 1/4 x 12	3 each	48 each	55	60
5 x 4	127 x 102	0.145	8	1/2 x 12-24	1 1/4 x 12	3 each	24 each	37	40
5 x 4 1/2	127 x 114	0.145	8	1/2 x 12-24	1 1/4 x 12	3 each	24 each	37	40
5 x 5	127 x 127	0.145	8	1/2 x 12-24	1 1/4 x 12	3 each	24 each	37	40
6 x 4 1/2	152 x 114	0.160	10	1/2 x 1/4-20	1 1/2 x 14	3 each	24 each	57	62
6 x 5	152 x 127	0.160	10	1/2 x 1/4-20	1 1/2 x 14	3 each	24 each	57	62
6 x 6	152 x 152	0.160	10	1/2 x 1/4-20	1 1/2 x 14	3 each	24 each	57	62

Hinge testing conforms to ANSI A156.1. Furnished with screw hole locations that conform to standards approved by ANSI A156.7.

"THE FIRST FAMILY OF SUPERIOR HARDWARE"

Full Mortise Hinges

Ball Bearing • Heavy Weight • Template
 For use on Heavy Weight Doors or Doors Requiring High Frequency Service

BB1168
 Steel with steel pin ANSI A8111

BB1199
 Brass with brass pin ANSI A2111
 Stainless Steel with stainless steel pin ANSI A5111

Five knuckle four ball bearings non-rising removable pin with button tip and plug.
 Specify screw requirements.

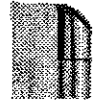
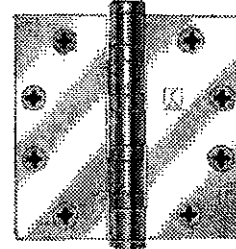

For Hospital type
 prefix "HT" to
 catalog number

Hinge Size		Gauge of metal	Number of holes	Screw Size		Quantity		Avg weight per case (lbs)	
Inches	Millimeters			Machine	Wood	Box	Case	Steel	SS/Steel/Brass
4 1/2 x 4	114 x 102	0.180	8	1/2 x 12-24	1 1/4 x 12	3 each	24 each	35	38
4 1/2 x 4 1/2	114 x 114	0.180	8	1/2 x 12-24	1 1/4 x 12	3 each	24 each	35	38
5 x 4	127 x 102	0.190	8	1/2 x 12-24	1 1/4 x 12	3 each	24 each	44	48
5 x 4 1/2	127 x 114	0.190	8	1/2 x 12-24	1 1/4 x 12	3 each	24 each	44	48
5 x 5	127 x 127	0.190	8	1/2 x 12-24	1 1/4 x 12	3 each	24 each	44	48
6 x 4 1/2	152 x 114	.203 Steel & Brass	10	1/2 x 1/4-20	1 1/2 x 14	3 each	24 each	70	65
6 x 5	152 x 127	.203 Steel & Brass	10	1/2 x 1/4-20	1 1/2 x 14	3 each	24 each	70	65
6 x 6	152 x 152	.203 Steel & Brass	10	1/2 x 1/4-20	1 1/2 x 14	3 each	24 each	70	65
8 x 6	203 x 152	.203 Steel & Brass	16	1/2 x 1/4-20	1 1/2 x 14	3 each	12 each	67	62
8 x 8	203 x 203	.203 Steel & Brass	16	1/2 x 1/4-20	1 1/2 x 14	3 each	12 each	67	62

Ball Bearing • Heavy Weight • Template • Wide Throw
 For use on Heavy Weight door or doors Requiring High Frequency Service

BB1168 - Wide Throw
 Steel with steel pin ANSI A5111

BB1199 - Wide Throw
 Brass with brass pin ANSI A2111
 Stainless Steel with stainless steel pin ANSI A5111

Five knuckle four ball bearings non-rising removable pin with tip and plug.
 Specify Screw Requirements.

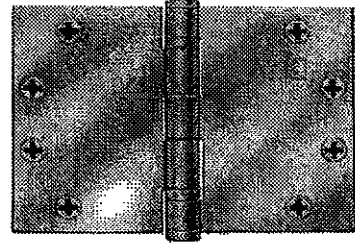

Hinge Size		Gauge of metal	Number of holes	Screw Size		Quantity		Avg weight per case (lbs)	
Inches	Millimeters			Machine	Wood	Box	Case	Steel	SS/Steel/Brass
4 1/2 x 5	114 x 127	0.180	8	1/2 x 12-24	1 1/4 x 12	3 each	24 each	55	60
4 1/2 x 6	114 x 152	0.180	8	1/2 x 12-24	1 1/4 x 12	3 each	24 each	55	60
4 1/2 x 7	114 x 178	0.180	8	1/2 x 12-24	1 1/4 x 12	3 each	24 each	55	60
4 1/2 x 8	114 x 203	0.180	8	1/2 x 12-24	1 1/4 x 12	3 each	24 each	55	60
5 x 6	127 x 152	0.190	8	1/2 x 12-24	1 1/4 x 12	3 each	12 each	32	35
5 x 7	127 x 178	0.190	8	1/2 x 12-24	1 1/4 x 12	3 each	12 each	32	35
5 x 8	127 x 203	0.190	8	1/2 x 12-24	1 1/4 x 12	3 each	12 each	32	35

Hinge testing conforms to ANSI A156.1. Furnished with screw hole locations that conform to standards approved by ANSI A156.7.

PH. 1-800-325-9995 or 1-314-772-4400 • Fax 1-800-782-0149 or 1-314-772-0744

5A

"THE FIRST FAMILY OF SUPERIOR HARDWARE"



SPECIFICATIONS - 9K SERIES

Certifications - ANSI A156.2, Series 4000 Grade 1 Federal Specifications FF-H-106C/Gen. Listed by Underwriter's Laboratories for use on 3 Hr, A label single swinging doors. GYJT builders hardware single point locks or latches. **Note:** Proper door preparation is mandatory or all warranty and liability for the product is voided.

Material - Lever handles are a high-quality zinc alloy. Trim components are brass or bronze. Critical latch and chassis components are brass, corrosion-treated steel, or stainless steel.

Finish - BHMA	US	DESCRIPTION
605	3	Bright Brass
606	4	Satin Brass
611	9	Bright Bronze
612	10	Satin Bronze
613	10B	Oxidized Satin Bronze, Oil Rubbed
618	14	Bright Nickel Plated
619	15	Satin Nickel Plated
622	19	Flat Black
625	26	Bright Chromium Plated
626	26D	Satin Chromium Plated

Chassis - 2-1/16" diameter to fit 2-1/8" hole in door (Conforms to ANSI A115.2)

Lever handles - Body is approximately 1-5/8" in diameter; Handle is approximately 4-3/4" long (from center-line of chassis). #14 and #15 levers conform to California Administrative Code Title 19 and Title 24. All three styles of levers conform to the Illinois Accessibility Standard.

Projection on Door - Approximately 2-3/4" when mounted on 1-3/4" door.

Roses - "C"- 3" Convex
 "D"-3-1/2" Convex
 "K"-3" Convex - no ring
 "L"- 3-1/2" Convex - no ring

Latch - 9/16" throw. Front 2-1/4" x 1-1/8" beveled. 3/4" throw optional (See Order Procedure below).

Backset - 2-3/4" standard, 3-3/4" and 5" available.

Strike - STK: Conforms to ANSI A115.3 (2-3/4" x 1-1/8" with curved lip & box). S3: Conforms to ANSI A115.2 for 1-3/4" doors (4-7/8" x 1-1/4" with curved lip).

Door Thickness - Available for 1-3/4" to 2-1/4" doors. Spacer available for 1-3/8" doors.

Mounting - In addition to standard door preparation (ANSI A115.2 for 1-3/4" doors), two additional holes are needed for thru-bolts. Thru-bolts require two 5/16" diameter holes located at 12 o'clock and 6 o'clock. A drill jig is provided to insure accuracy of the holes. (see page 6B.11).

Products covered by one or more of the following patents:

U.S.:			
D290,085	4,437,695	4,428,212	
4,843,852	4,318,558	4,428,570	
4,262,507	4,496,178	4,779,908	
		5,116,170	

Canada:
 1,184,773 1,194,057 1,229,358
 Other products patent pending.



ORDER PROCEDURE

9K Lever Handle Cylindrical

STEP 1	2	3	4	5	6	7	8
93K	7	AB	14	K	STK	626	
Backset	Core Housing	Function Code	Lever Style	Rose Style	Strike Package	Standard Finishes *	Options
93K-2 3/4" 94K-3 3/4" 95K-5"	O-keyless 7-7 pin housing accepts all Best cores.	AB-corridor D-storeroom L-privacy N-passage R-classroom Etc. page 6B.6-8	14-curved return 15-contour angle return 16-curved no return page 6B.4-5	C- 3"convex D- 3-1/2" convex K- 3"convex - no ring L- 3-1/2" convex - no ring	STK-2-3/4" ANSI S3- 4-7/8" ANSI page 6B.10	605 606 611 612 613 618 619 625 626 (For all available finishes see above)	AL-abrasive lever LL-lead lined SH-security head screws 3/4"-3/4"throw latch NOTE:specify inside (I), outside(O),or both (B) for AL,TL options TL-tactile lever (not available in #15)

* Handles are made from a zinc alloy, and have been plated to be equivalent in appearance to the finishes listed.

CYLINDRICALS - LEVERS



9K SERIES - FEATURES

9K Exploded View

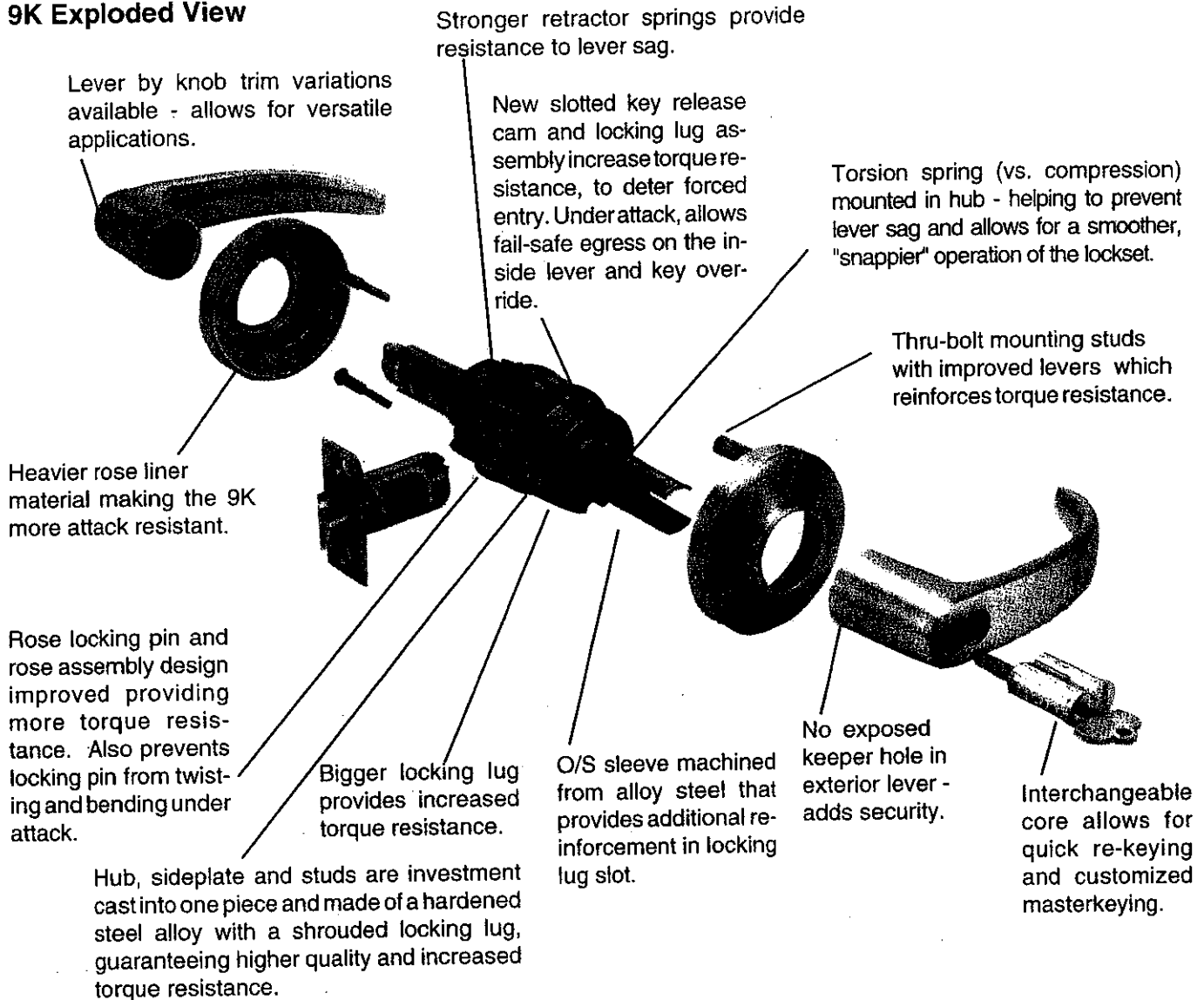

9K CYLINDRICAL - OPTIONS

ABRASIVE LEVERS

Besides complying with a wide variety of handicapped codes and ordinances, Best Lock lever handles are available with a special abrasive feature. Abrasive strip on the lever immediately identifies warnings on doors to hazardous areas for the blind. **TO ORDER:** Designate choice of abrasive lever - AL option on Step 8 of order procedure (page 6B.3).

Note: Abrasive strip is available on all levers, however **NOT** on #14 and #16 levers in 613 finish.

TACTILE LEVERS







Tactile levers may be used in areas where improved grip is required or as a warning in hazardous or safety first areas. Grooves are machined into the back of the hand grasp portion of the lever to improve grip and/or to provide a sensory warning. This option can be used for Blind, Safety, or Handicapped applications. **TO ORDER:** Designate "TL" on step 8 of order procedure (page 6B.3).

Note: The (TL) option will be available on #14 and #16 levers in all finishes. The (TL) option will **NOT** be available

CYLINDRICALS - LEVERS

9K SERIES - FUNCTION DESCRIPTIONS

Single keyed functions

Function & Diag. (ANSI No.)		Description	Outside lever		Inside lever	
		Latch operated by	locked by	unlocked by	locked by	unlocked by
AB F81	 Corridor lock	<ul style="list-style-type: none"> Rotating the inside lever, OR Rotating the outside lever—only when the inside push button is out. 	<ul style="list-style-type: none"> Pushing the inside button, QB Pushing and turning the inside button. Turning the button keeps the outside lever locked until the button is turned back. 	<ul style="list-style-type: none"> Turning the key in the outside lever, QB Rotating the inside lever, OR Closing the door. 	Cannot be locked	Always unlocked
D F86	 Storeroom Lock	<ul style="list-style-type: none"> Turning the key in the outside lever, QB Rotating the inside lever. 	Always fixed	Cannot be unlocked	Cannot be locked	Always unlocked
E F92	 Service Station Lock	<ul style="list-style-type: none"> Rotating the inside lever, OR Rotating the outside lever—only when the inside push button is out. Turning the key in the outside lever. 	<ul style="list-style-type: none"> Pushing the inside button, QB Pushing and turning the inside button. Turning the slotted button keeps the outside lever locked until the button is turned back. 	<ul style="list-style-type: none"> Turning the key in outside lever, QB Rotating the inside lever, OR Closing the door, only when the slotted push button is unlocked. Turning the slotted button back. 	Cannot be locked	Always unlocked
H F93	 Hotel Guest Room Lock	<ul style="list-style-type: none"> Rotating the inside lever, OR Turning the key in the outside lever—only when the inside push button is out, QB Removing the core with a control key and using a special emergency key. 	Always fixed	Key block feature is released by: <ul style="list-style-type: none"> Rotating the inside lever, OR Closing the door. 	Cannot be locked	Always unlocked
*Pushing the inside button displays an "occupied" indicator in the outside lever and blocks all operating keys.						
HJ	 Hotel Guest Room Lock	<ul style="list-style-type: none"> Rotating the inside lever, OR Turning the key in the outside lever—only when the inside push button is out, QB Removing the core with a control key and using a special emergency key. 	Always fixed	Key block feature is released by: <ul style="list-style-type: none"> Rotating the inside lever, OR Closing the door. 	Cannot be locked	Always unlocked
*Pushing the inside button blocks all operating keys, but no "occupied" indicator is displayed.						
R F84	 Classroom Lock	<ul style="list-style-type: none"> Rotating the inside lever, OR Turning the key in the outside lever, QB Rotating the outside lever when not locked by key. 	Turning the key in the outside lever.	Turning the key in the outside lever.	Cannot be locked	Always unlocked
T F90	 Dormitory Lock	<ul style="list-style-type: none"> Rotating the inside lever, OR Rotating the outside lever when not locked by key or push button. 	<ul style="list-style-type: none"> Turning the key in the outside lever, QB Pushing the button on the inside lever. 	<ul style="list-style-type: none"> Turning the key in the outside lever, QB Rotating the inside lever (only when locked by push button), OR Closing the door (only when locked by push button). 	Cannot be locked	Always unlocked

Double keyed functions*

C F88	 Corridor lock	<ul style="list-style-type: none"> Rotating the inside lever, QB Rotating the outside lever when not locked by key, OR Turning the key in the outside lever. 	Turning the key in the inside lever.	Turning the key in the inside lever.	Cannot be locked	Always unlocked
----------	---	---	--------------------------------------	--------------------------------------	------------------	-----------------





* **WARNING:** Locksets that secure both sides of the door are controlled by building codes and the Life Safety Code. In an

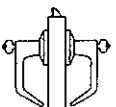
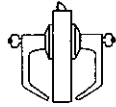
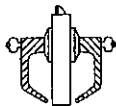

9K SERIES FUNCTIONS

Function & Diag. (ANSI No.)	DESCRIPTION	Outside lever		Inside lever	
		locked by	unlocked by	locked by	unlocked by
G F91 	Storeroom Lock <ul style="list-style-type: none"> Rotating the outside lever when not locked by key, OR Rotating the inside lever when not locked by key. 	<ul style="list-style-type: none"> Turning the key in the inside lever, OR Turning the key in the outside lever. 	<ul style="list-style-type: none"> Turning the key in the inside lever, OR Turning the key in the outside lever. 	<ul style="list-style-type: none"> Turning the key in the inside lever, OR Turning the key in the outside lever. 	<ul style="list-style-type: none"> Turning the key in the inside lever, OR Turning the key in the outside lever.
*Turning the key in either the inside OR the outside, locks or unlocks both sides.					
S F80 	Communicating Lock <ul style="list-style-type: none"> Turning the key in the inside lever, OR Turning the key in the outside lever. Turning the inside or outside lever (if unlocked) 	Turning the key in the outside lever.	Turning the key in the outside lever.	Turning the key in the inside lever.	Turning the key in the inside lever.
*Turning the key in either lever, locks or unlocks its own lever independently.					
W F87 	Institutional Lock <ul style="list-style-type: none"> Turning the key in the inside lever, OR Turning the key in the outside lever. 	Always fixed	Cannot be unlocked	Always fixed	Cannot be unlocked

Keyless functions

L F76 	Privacy lock <ul style="list-style-type: none"> Rotating the inside lever, OR Rotating the outside lever only when the inside push button is out. 	Pushing the inside button	Rotating the outside slotted lever, OR rotating the inside lever, OR pushing the inside button	Cannot be locked	Always unlocked
N F75 	Passage Lock <ul style="list-style-type: none"> Rotating the inside lever, OR Rotating the outside lever. 	Cannot be locked	Always unlocked	Cannot be locked	Always unlocked
NX F75 	Exit Lock <ul style="list-style-type: none"> Rotating the inside lever. 	Always fixed	Cannot be unlocked	Cannot be locked	Always unlocked
P F77 	Patio Lock <ul style="list-style-type: none"> Rotating the inside lever, OR Rotating the outside lever—only when the inside push button is out. 	Pushing the inside button	Rotating the inside lever, OR pushing the inside button	Cannot be locked	Always unlocked
Y 	Exit Lock <ul style="list-style-type: none"> Rotating the inside lever. 	Always fixed	Cannot be unlocked	Cannot be locked	Always unlocked

1DT **Single Dummy Trim** This is a single, surface-mounted lever for an inactive door or a non-latching door.



2DT **Double Dummy Trim** This is a thru-bolt mounted pair of matching levers for an inactive door or a non-latching door.



9K SERIES - TRIM VARIATIONS

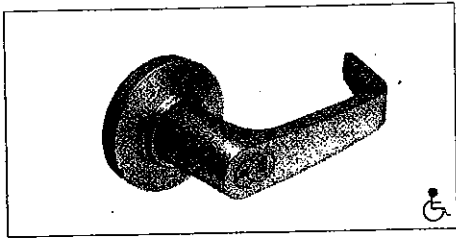

15C

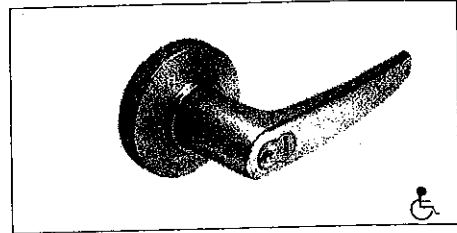

16C

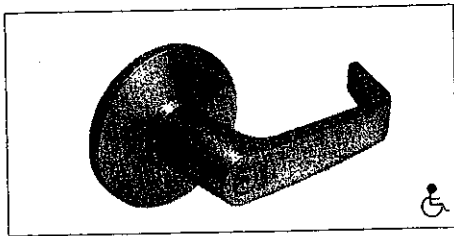

15D

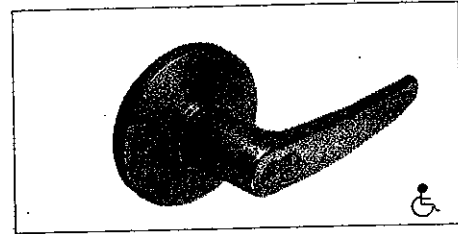

16D

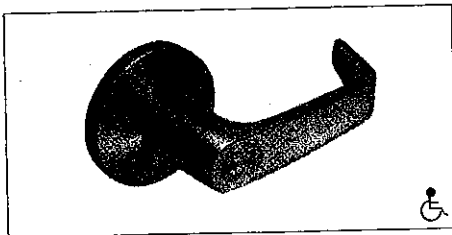

15K

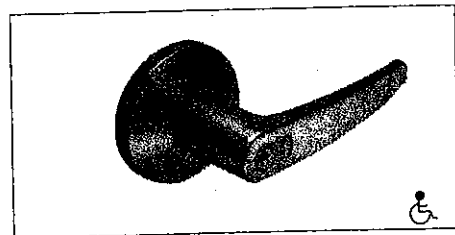

16K

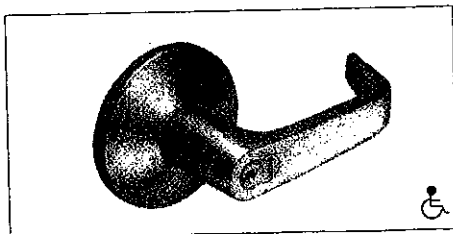

15L

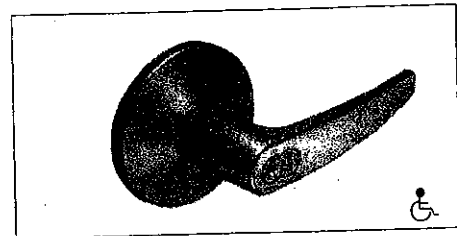

16L

CYLINDERS

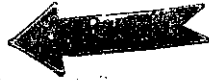

1E SERIES - CYLINDERS

1E MORTISE CYLINDER

Standard mortise applications require use of Best's 1E Series cylinders with standard 1E-C4 cam. Best cylinders may be altered to function with other manufacturers' locks by use of different cams (see page 9.8) and different cylinder rings (see page 9.9).

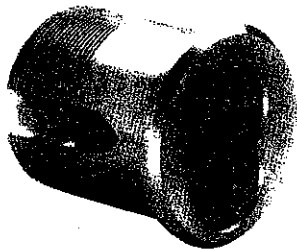

Special cylinder variations are available for most applications (see pages 9.4 & 9.5).

Best cylinders are machined from brass or bronze bar stock and are available in a variety of finishes. Additional security is provided by a set screw that mounts diagonally in the cylinder wall and when tightened, holds the cylinder securely in the housing. Best mortise cylinders feature the Best interchangeable core and may be masterkeyed into any existing Best system. Contact your local Best Representative for information on special cylinder applications not listed in this catalog.

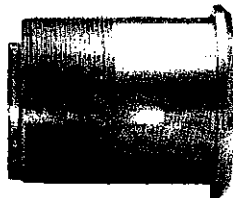

SPECIFICATIONS

CYLINDER NOMENCLATURE	DIMENSION "A"	DOOR THICKNESS
1E-64	1-1/8"	1-5/8" to 2-1/4"
1E-74	1-1/4"	1-7/8" to 2-1/2"

CYLINDER DIAMETER - 1-5/32"

To Order: see below. Example: 1E74-C4-RP3-626

Products covered by one or more of the following patents.

4,437,695 4,633,690 4,616,394

HOW TO ORDER:

STEP: A	B	C	D	E	F	G	H	**
1E	7	4		C4	RP3	626		
CYLINDER DIAMETER	CORE HOUSING	FUNCTION CODE	STANDARD MORTISE LENGTH CODE	CAM OR SPINDLE	RINGS	STANDARD FINISHES	OPTIONS	
1E-1-5/32"	0-dummy	2-rim	Blank-standard	C4-standard cam	RP-rim cylinder	605 606	MC-marine	
3E-1-1/2"	6-6 pin	4-mortise*	22-1-3/8"	C181-Adams Rite	RP1-tapered cyl.	612 613	construction	
5E-see page 9.10	7-7 pin housing	6-tapered mortise	24-1-1/2" etc. up to 96'-6"	MS cam	RP2-6 pin mortise	625 626		
8E-see page 9.7	accepts all Best cores		(see page 9.4 and 9.5)	S2-standard spindle (special cams see page 9.8)	RP3-7 pin mortise RP4-3E mortise (special rings-see page 9.9)		Specify hand if required	

* For additional special mortise cylinders, see pages 9.4 and 9.5.

** Must specify keymark and number of keys or designate L/C for less core.

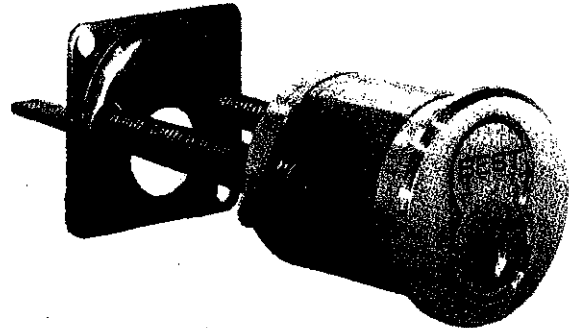

1E RIM CYLINDER

Standard rim cylinder applications require the use of Best's 1E rim cylinder series. Best rim lock cylinders are interchangeable with other manufacturers' rim locks. Best rim cylinders are machined from solid bar stock and are available in a variety of finishes. The standard package for the Best rim cylinder includes cylinder, 1E-R3 and 1E-R5 rings, 1E-S2 spindle, clamp plate and clamp plate screws. Best rim cylinders feature the Best interchangeable core and may be masterkeyed into any existing Best system.

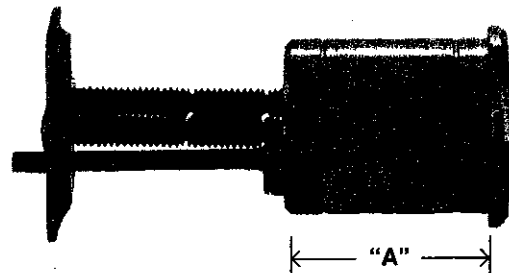

SPECIFICATIONS

CYLINDER NOMENCLATURE	DIMENSION "A"	DOOR THICKNESS
1E-62	1-3/16"	1" to 2-3/4"
1E-72	1-11/32"	1-1/4" to 3"

CYLINDER DIAMETER- 1-5/32"

To Order: see page 9.2 example: 1E72-S2-RP-626



6000 SERIES PUSH-PULL LATCH

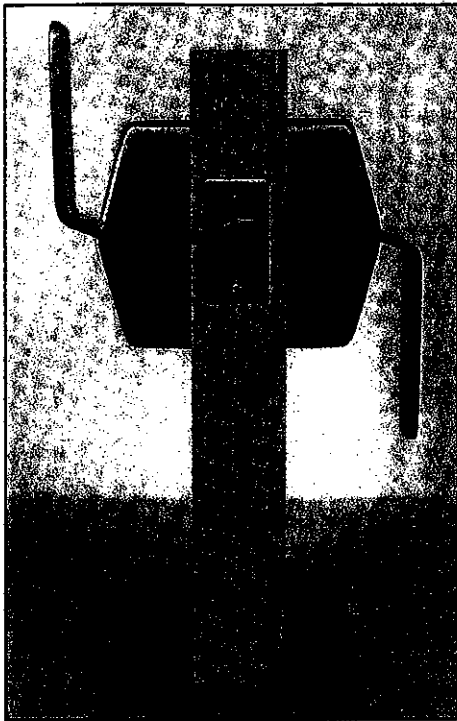

- Non-handed (except for engraved models). **SEE NOTE BELOW.***
- Push/pull latch can be mounted with the handles up, down or horizontal without any modification.
- Available with 2 3/4", 5" or 7" backset latches.
- Standard or ASA strike.
- Includes all required fasteners.
- Compact non-handed covers provide maximum clearance between the handle and door.
- UL listed for all fire doors.
- Available in BHMA finishes.
- Lead lining is available.
- Available latch bracket for Roller to Push Pull conversion.
- Meets ADA requirements.

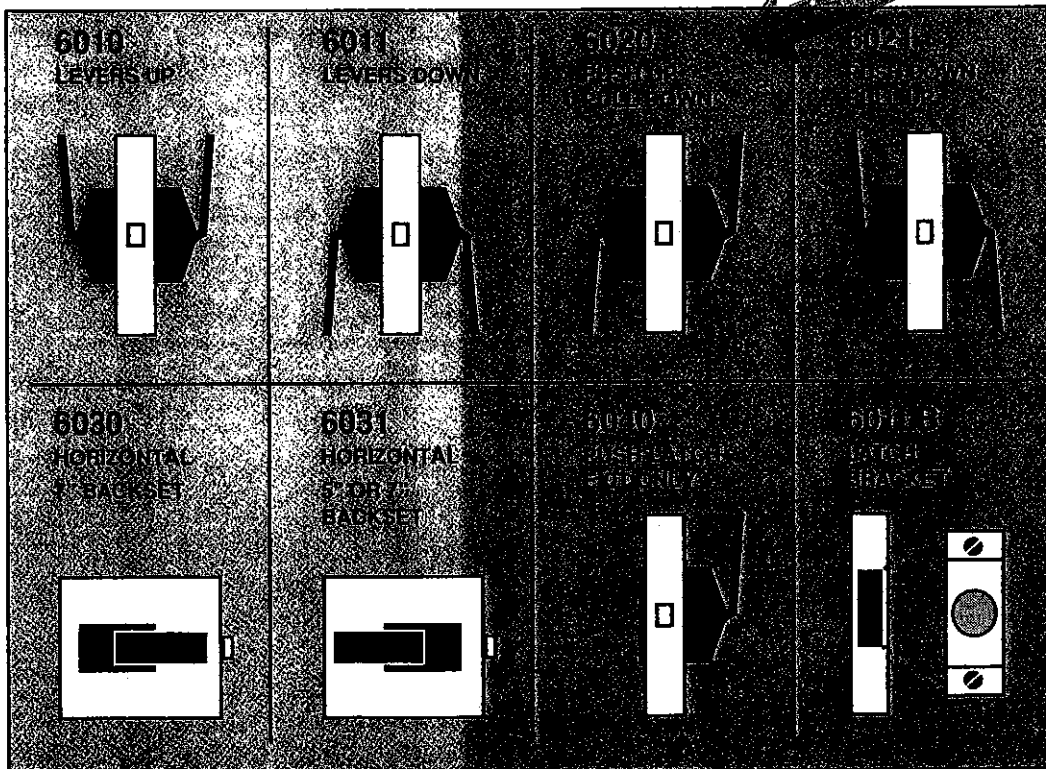

* When ordering engraved models, add the letter **P** after the numbers shown below and designate hand.

Visit our web site at <http://www.abhmfg.com>
Architectural Builders Hardware Mfg., Inc.
 500 Crossen Ave.
 Elk Grove Village, IL 60007
 847.437.9901; FAX 800.9FAXABH (932.9224)

ABH is a minority owned and operated manufacturing company

© 1997 ABH Mfg., Inc.
 Printed in USA 397



6000 SERIES PUSH/PULL LATCH

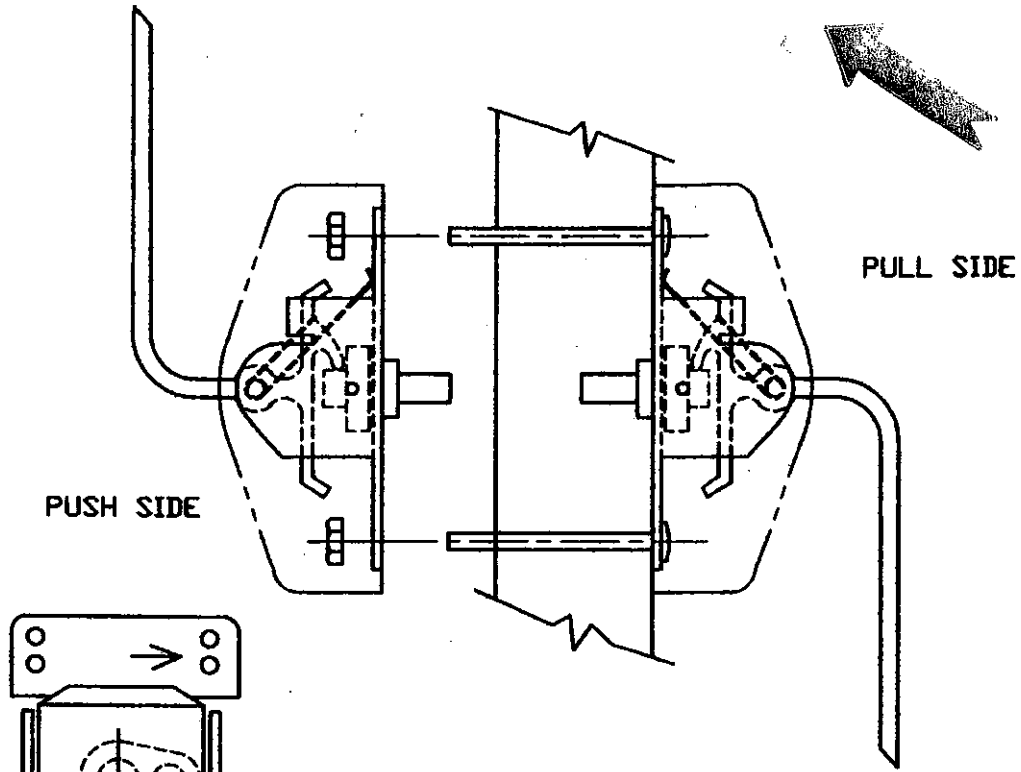

NOTE:
 BEFORE MOUNTING PUSH AND PULL HANDLES,
 CAM PIN MUST BE ROTATED TOWARD SIDE INDICATED
 BY ARROW STAMPED ON BASE

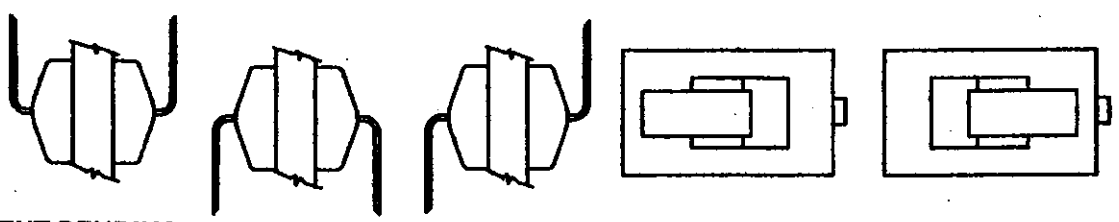

PATENT PENDING

SCREW DETAIL		
	WOOD DOOR	METAL DOOR
PUSH/PULL HANDLE	(4) 10-32 X 2-3/4" PAN HD. M.S. (4) 10/32 NUT	(4) 10-32 X 2-3/4" PAN HD. M.S. (4) 10/32 NUT
COVER	(4) 8-32 x 3/8" F.H.M.S.	(4) 8-32 x 3/8" F.H.M.S.
LATCH	(2) #6 X 3/4" F.H.W.S.	(2) 6-32 x 3/8" F.H.M.S.
STD STRIKE	(2) #8 X 3/4" F.H.W.S.	
ASA STRIKE		(2) 12-24 X 3/8" F.H.M.S.

Visit our web site at <http://www.abhmfg.com>
Architectural Builders Hardware Mfg., Inc.
 500 Crossen Ave.
 Elk Grove Village, IL 60007
 847.437.9901; FAX 800.9FAXABH (932.9224)

ABH is a minority owned and operated manufacturing company
 © 1997 ABH Mfg., Inc.
 Printed in USA 397



VON DUPRIN®

98/99 Rim Devices

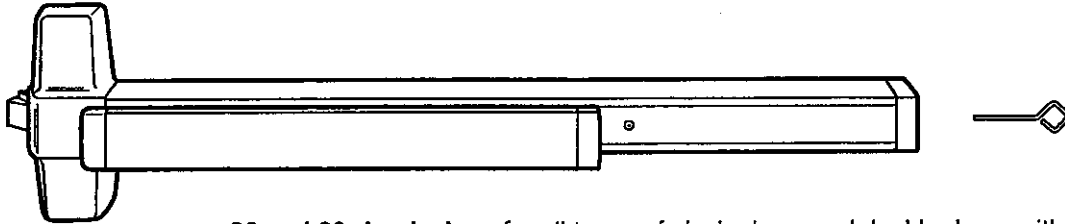
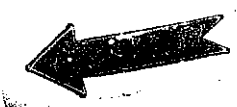

98 and 99 rim devices for all types of single doors and double doors with mullion, UL listed for accident hazard installations. Covers stock hollow metal doors with 86 or 161 cutouts.



FEATURES

- Nonhanded
- Field sizeable
- $\frac{3}{4}$ " (19mm) throw, latch bolt
- Latch bolt deadlocking
- Eight popular finishes
- Hex key dogging

DIMENSIONS

Touchbar height to finished floor	$39\frac{13}{16}$ " (935mm) at center
Touchbar projection —	
neutral	$3\frac{13}{16}$ " (97mm)
depressed	$3\frac{1}{8}$ " (78mm)
Center case	$8" \times 2\frac{1}{4}" \times 2\frac{3}{4}"$ (203mm \times 57mm \times 70mm)
Device length — Short 3'	2'6" to 3' (762mm to 914mm) door size
Long 4'	3'1" to 4' (940mm to 1219mm) door size

OUTSIDE TRIM

Standard

990NL-R/V
990TP-R/V
990DT
110NL-MD
991K-R/V
992L-R/V

Optional

990EO
696NL-R/V
696TP-R/V
696DT
697NL-R/V
697TP-R/V
697DT
KP992L-R/V
994L-R/V
110NL-WD
392-7

For complete outside trim information, see pages 18-19.

STRIKES AND FASTENERS

Device is furnished with standard 299 strike in dull black finish. All necessary fasteners are included. Optional strikes and finishes are available. For strike applications, dimensions, and minimum door stile information refer to pages 22, 23.

A combination of fasteners are included for surface mounting and through bolting to trim on $1\frac{3}{4}$ " (44mm) and $2\frac{1}{4}$ " (57mm) thick doors.

DEVICE OPTIONS

Electric latch retraction, page 24
Pneumatic latch retraction, page 27
Electric rim device, page 25
Request to exit switch, page 26
Latch bolt monitoring, page 26
Signal switch, page 26
Cylinder dogging, page 30
Double cylinder, page 27

For How-To-Order Information on all devices, see page 35.



VON DUPRIN®

98/99 Additional Information

NOMENCLATURE

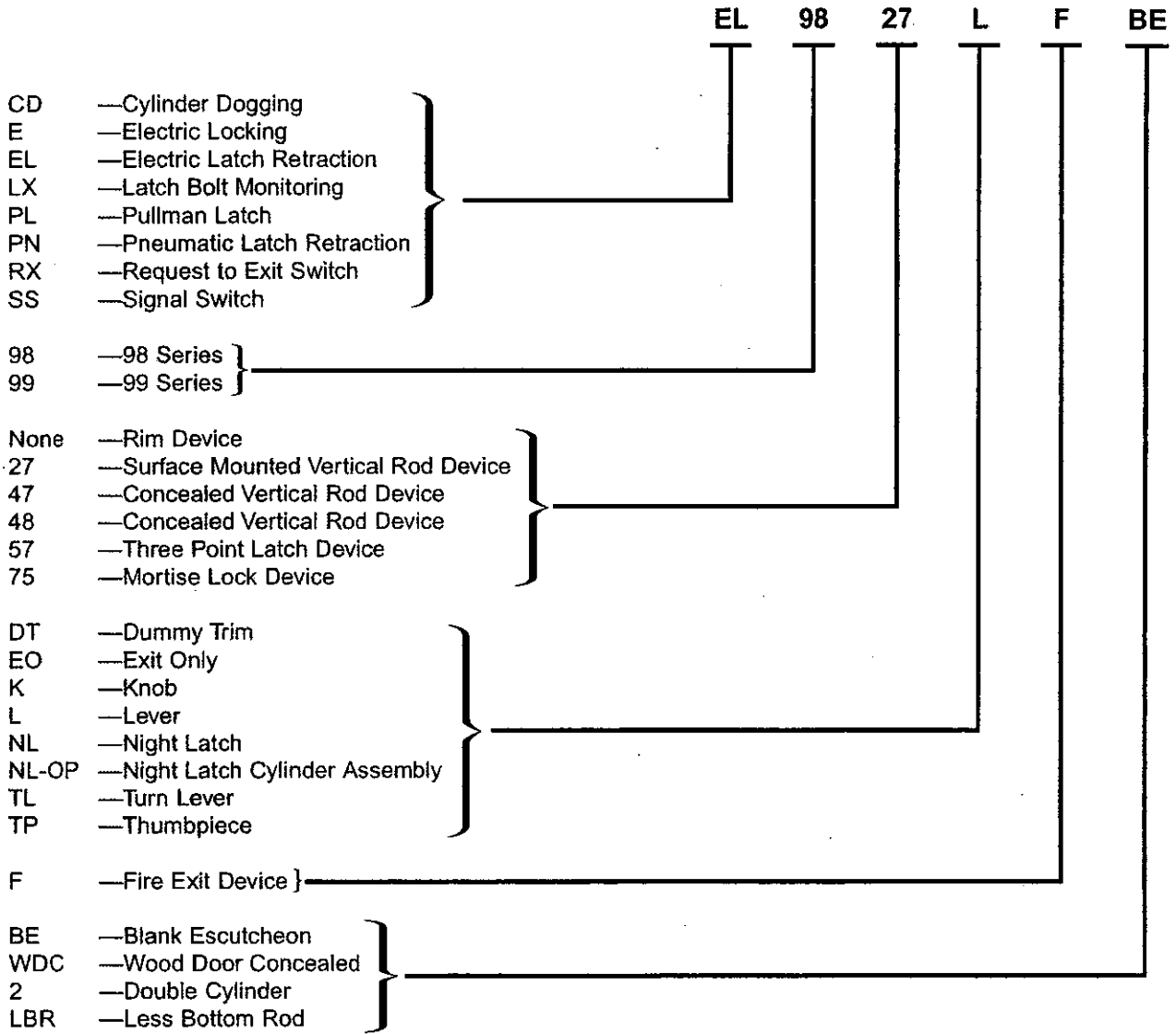

VON DUPRIN®

98/99 Additional Information

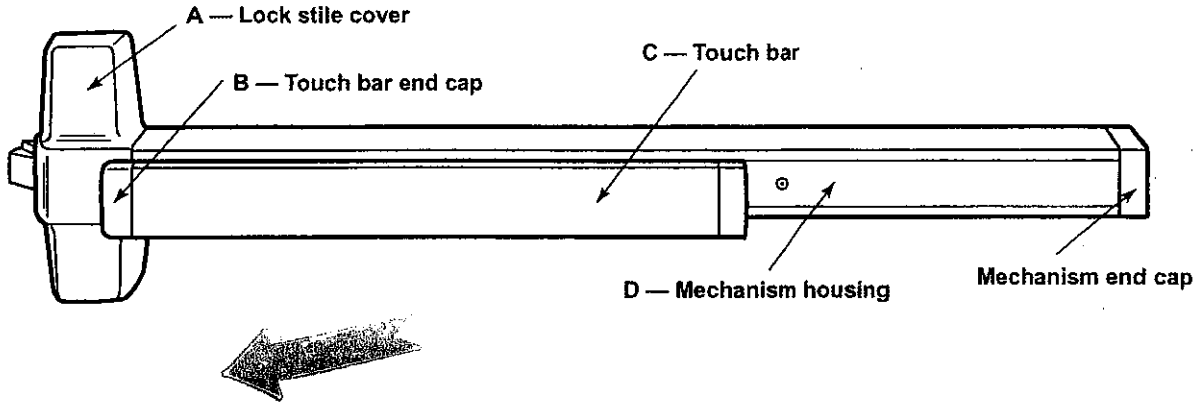

FINISHES

Color*	US Number	BHMA Number	A, B, E	C	D
Brass, Polished	US3	BHMA605	Plated	Brass, Polished US3, BHMA605	Buffed Anodized
Brass, Satin	US4	BHMA606	Plated	Brass, Dull US4, BHMA606	Anodized
Bronze, Satin	US10	BHMA612	Plated/Anodized Bronze, Dull US10, BHMA612		Anodized
Chrome, Polished	US26	BHMA625	Plated	Stainless Steel, Polished US32, BHMA629	Buffed Anodized
Chrome, Satin	US26D	BHMA626	Plated	Stainless Steel, Satin US32D, BHMA630	Anodized
Stainless Steel, Satin	US32D	BHMA630	Stainless Steel	Stainless Steel, Satin US32D, BHMA630	Anodized
Aluminum, Anodized	US28	BHMA628	Painted	Stainless Steel, Satin US32D, BHMA630	Anodized
Duranodic Dark Bronze	313	—	Painted	Wood grain vinyl**	Anodized

Touch Bar Options. — Knurled — Black vinyl — Walnut grain vinyl — Embossed "Push", brass, bronze or stainless steel

*US32D Finish — available on Series 98, consult factory.

**US10B available, consult factory.

VON DUPRIN® 98/99 Accessories

DUMMY PUSH BAR



The 330 grooved and 350 smooth dummy push bars are designed as a companion unit for all 98 or 99 devices. The touch bar is rigid and non-functioning. A push/pull operation can be accomplished by using 990DT, 696DT, or 697DT trim.

To order, specify:

1. 330 or 350.
2. Size, 3' or 4' (914mm or 1219mm).
3. Finish, see page 35.

CYLINDER DOGGING — CD



Cylinder dogging is available on all 98/99 devices to replace the standard hex key dogging. Furnished, not installed. Unit requires a standard 1 1/4" (32mm) mortise cylinder.

To order, specify:

1. Prefix CD, example CD99NL.

CYLINDER DOGGING KIT — CDK

For field conversion, a cylinder dogging conversion kit is available. Order: 33/99CDK or 35/98CDK, specify finish.

HEX KEY DOGGING KIT — HDK

For field conversion, a hex key dogging conversion kit is available. Order: 33/99HDK or 35/98HDK, specify finish.

GLASS BEAD KIT

Glass bead conversion kits are available for all 99 Series devices for use on doors with raised glass beads. Each kit consists of 1/4" (6mm) shim sets.

To order, specify:

1. 99GBK.
2. Device type (rim, mortise, surface vertical and concealed vertical rod.)
3. Wood door, when used with concealed vertical.

COVER PLATES KIT — 997 KIT

For 99 rim device, kit contains inside and outside plates for hinge stile cutouts, an inside plate for the lock stile, and necessary screws. Plates are designed to cover cutouts required by most existing exit device installations. Specify finish.

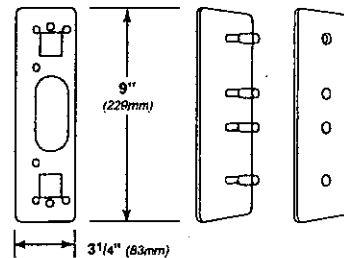

CYLINDERS

Cylinders are not furnished with device or trim and must be specified when ordering. Rim, surface vertical rod, and concealed vertical rod exit devices use rim type cylinders. Mortise lock exit devices and series 370 controls use mortise type cylinders.

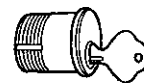

Mortise - 3215 (Schlage B502-191 cam)

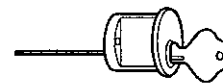
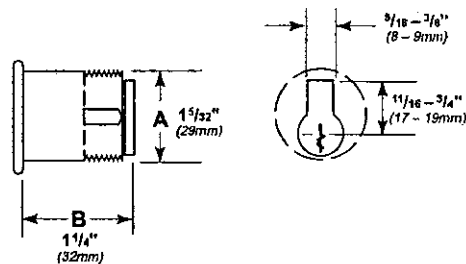

Rim - 3216

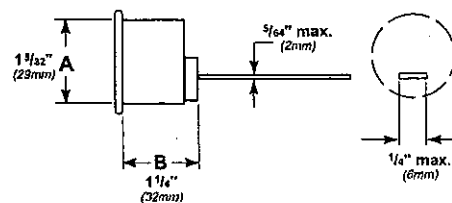

**SUPER SMOOTHEE®
SURFACE MOUNTED CLOSER**

Specify finish (F), hand (H), size (S), and cylinder function (C) where indicated.

CYLINDER

4040-3071 Cylinder Assembly F,S,C
 SIZE: 1
 4041-3071 cylinder adjustable from size 1 thru 6.
 CYLINDER FUNCTION: Regular, Delay.
 -3071 regular cylinder provides all normal functions.
 -3071DA cylinder provides delayed closing action from maximum opening until approximately 70°.

INDIVIDUAL PARTS

Parts for 4040-72	Cover	
Parts for 4040-72LL	Lead Lined Cover	
4040-31	Cover Screw (2)	F
4040-163	Arm Inserts	F
4040-164	Screw Inserts (2)	F
4040-159	Arm Screw	F

COVER

4040-72	Standard Cover	F
	Includes (2) 4040-31, -163 and -164.	
4040-72LL	Lead Lined Cover	F
	Includes (2) 4040-31 -163 and -164.	
4040-72MC	Metal Cover	F,H
	Includes (2) 4040-31.	

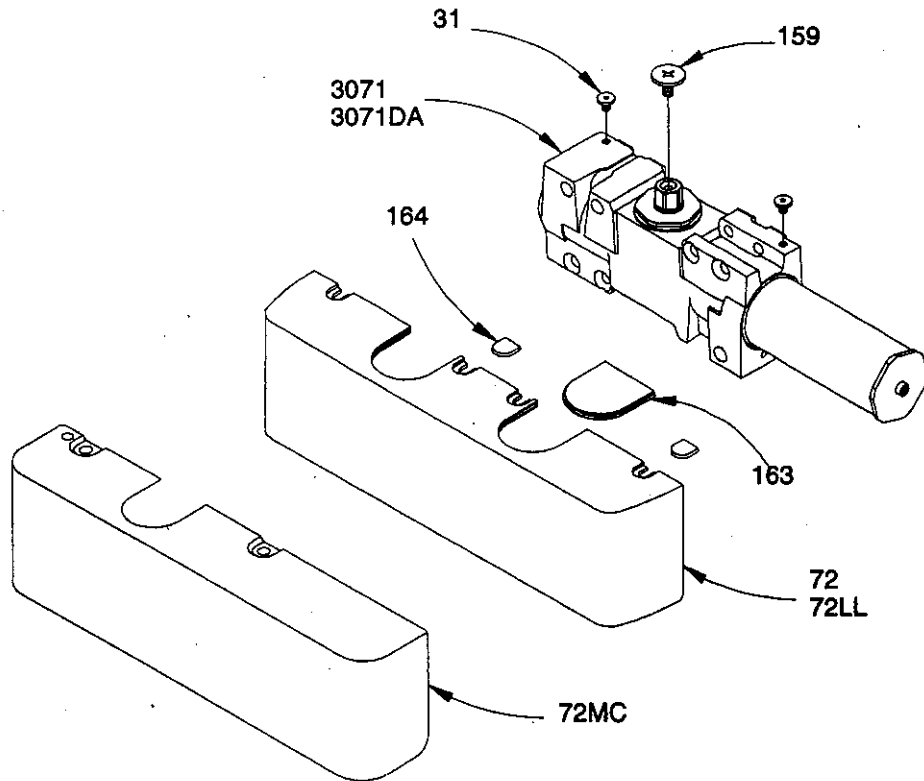

**SUPER SMOOTH™
SURFACE MOUNTED CLOSER**

Specify finish (F) and hand (H) where indicated.

COMPLETE ARM

4040-3077EDA Extra Duty Arm
Includes 4040-159 and -201.

F

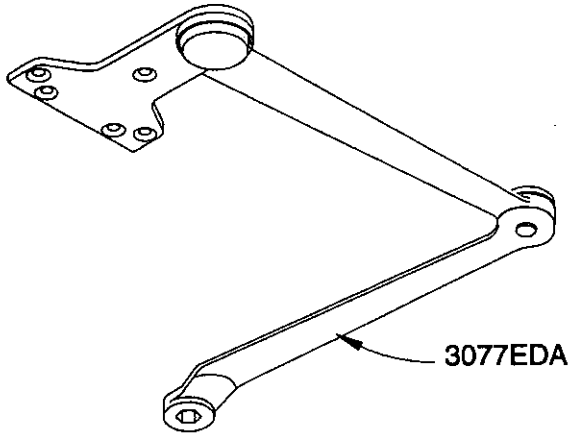

3077EDA

COMPLETE ARM

4040-3049EDA Extra Duty Arm
Includes 4040-159.

F,H

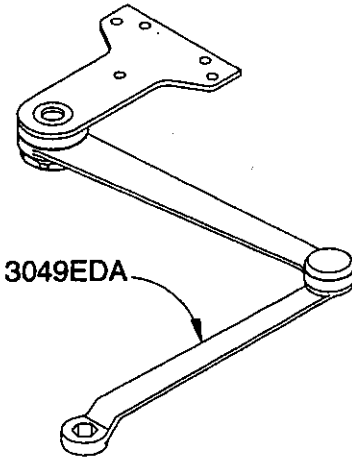

3049EDA

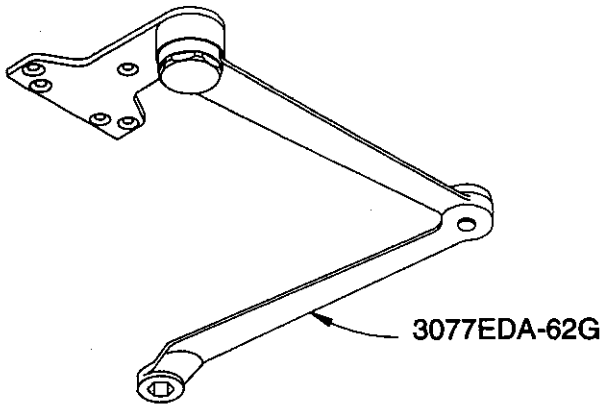

3077EDA-62G

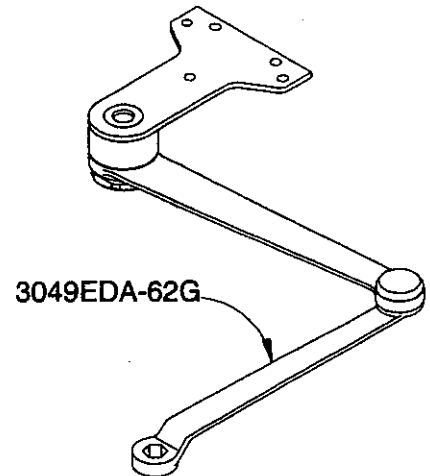

3049EDA-62G

COMPLETE ARM

4040-3077EDA-62G Extra Duty Arm
Includes 4040-159 and -201.

F

COMPLETE ARM

4040-3049EDA-62G H Extra Duty Arm
Includes 4040-159.

F,H

**SUPER SMOOTHEE®
SURFACE MOUNTED CLOSER**

Specify finish (F) and hand (H) where indicated.

COMPLETE ARM

4040-3077CNS Cush-N-Stop Arm
Includes 4040-159.

F

COMPLETE ARM

4040-3049CNS H Cush-N-Stop Arm
Includes 4040-159.

F

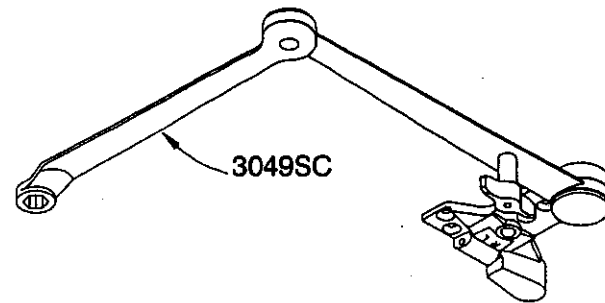
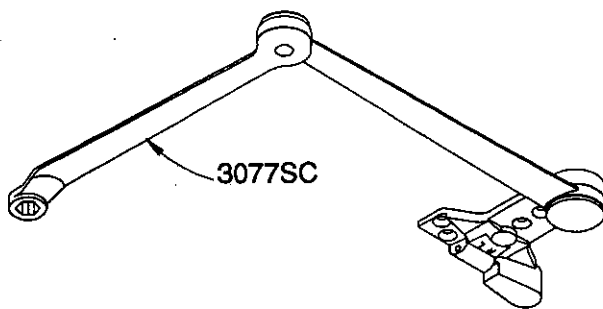
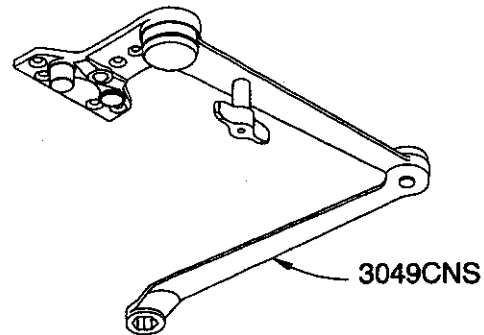
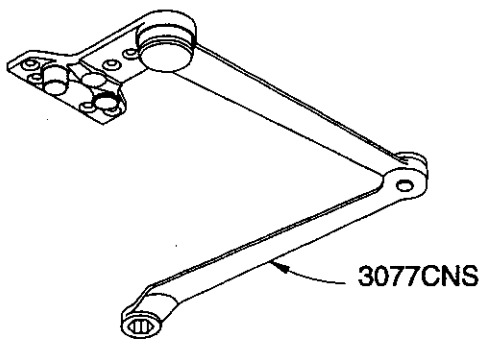

COMPLETE ARM

4040-3077SC Spring Cush Arm
Includes 4040-159.

F

COMPLETE ARM

4040-3049SC H Spring Cush Arm
Includes 4040-159.

F



A member of the Yale Security Group

HEAVY DUTY 9 SERIES Surface Mount - Interior or Exterior Doors

Standard Features

- Surface mounted
- Non-handed
- Slide track design
- For use on exterior or interior doors
- Recommended for high traffic, heavy abuse installations
- Heavy shock absorber spring provides 5°-7° compression before dead stop
- On/off knob on hold open models
- Stop, friction stay or hold open function
- Complete screw packet allows for installation in wood or metal door and frame
- For security areas torx screws, optional
- Standard architectural finishes
- Non-metal slide block and shock block
- 110° maximum opening
- 1-3/4" minimum door thickness
- LS option available for doors being used with electromechanical closers and floor closers with dead stop
- Mount on pull side of door use bracket 5458 LH or 5459 RH

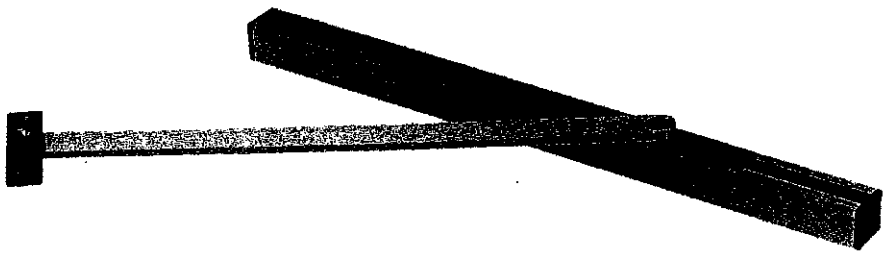
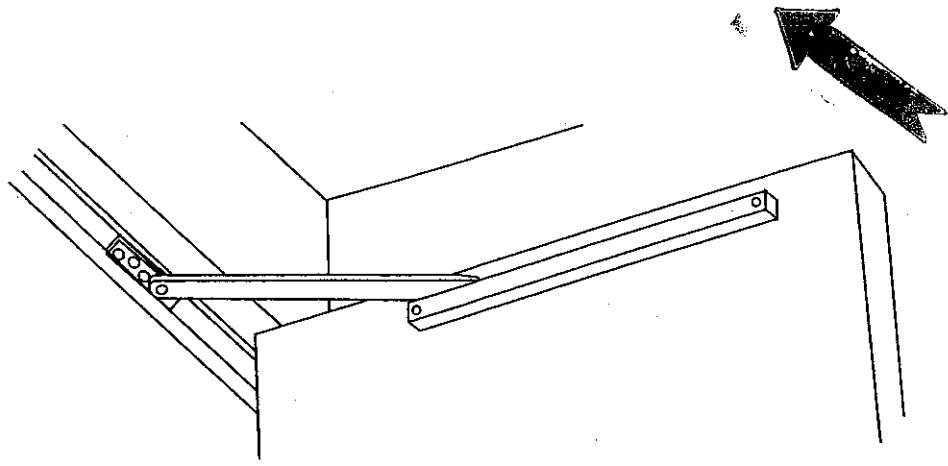

Door Opening Chart (in inches)

Model Number

Butts Offset Pivots	Center Hung Pivots	Friction	H.O.	Stop
*24 - 28	25-1/2-30	9-116	9-126	9-136
28-1/16-33	30-1/16-36	9-216	9-226	9-236
33-1/16-38	36-1/16-41	9-316	9-326	9-336
38-1/16-43	41-1/16-46	9-416	9-426	9-436
43-1/16-48	46-1/16-50	9-516	9-526	9-536

*Butt hung only on this size door.

ANSI No.			
Shipping Weight	Friction	H.O.	Stop
4.5 lbs.	----	C02511	C02541



Doorplates

Kickplates are an attractive means of protecting a door surface from scuffing due to heavy traffic. A range of heights is available to provide protection from damage by floor cleaning operations, stretchers, industrial carts and trucks. Plates are available in all architectural finishes plus a variety of plastic materials.

Standard Features:

- All Plates individually packed with screws.
- Stainless Steel 18-8 Phillips head sheet metal screws plated to match.
- Nominal Thickness: Metal Plates - .050", Plastic Plates - .125".
- All Architectural Finishes available up to 48" x 48" except US26D (626) which has a maximum height of 12".
- Westinghouse Micarta® Plastic Laminate is in stock in the following colors: #90M52 Gray, #52M33 Sand, #92M16 Pearl Black, #90M21 Chocolate Brown, #92M90 Cool White. B4E is standard.
- Kydex 160 Heavy Duty PVC/Acrylic Alloy Plastic is stocked in the following colors. #72010 Chocolate Brown, #52001 Pewter Gray, #52000 Calcutta Black, #72005 Beige, #72047 Cocoa.
- Clear Acrylic Plastic. B4E is standard.
- Compliance with BHMA ANSI A156.6 Standards:
Metal Armorplate = J101
Metal Kickplate = J102
Metal Mopplate = J103
Plastic Armorplate = J105
Plastic Kickplate = J106
Plastic Mopplate = J107.

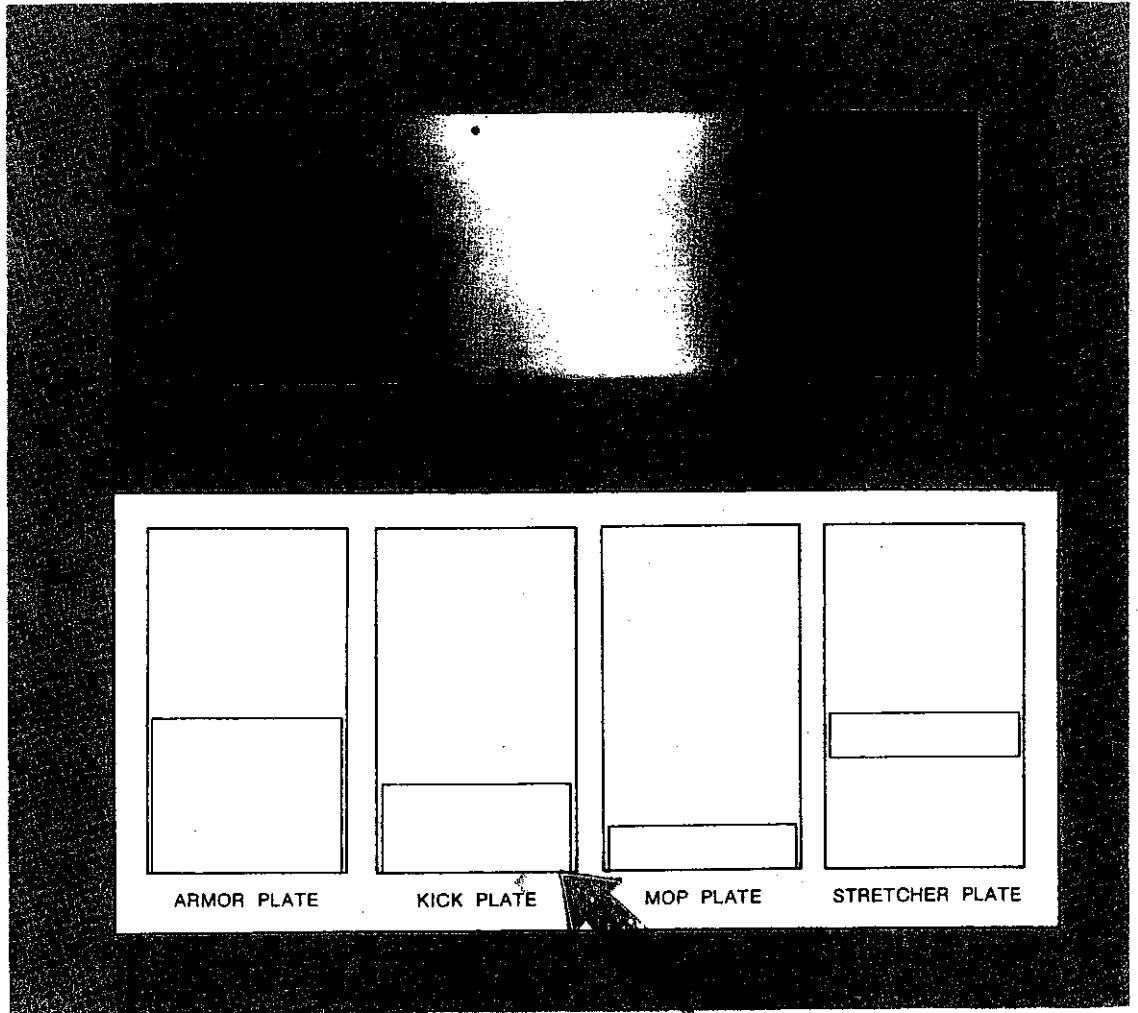

Doorplates are commonly used for protective purposes; for best protection mount plates flush with the bottom of the door. If plates are used primarily for aesthetic reasons (i.e. Brass Kickplates), it may be desirable to mount them up to 1" from the bottom of the door.

Optional Features:

- Beveled 3 or 4 edges, specify "B3E" or "B4E".
- Machine Screws or Spanner Head Screws.
- Cut outs for Locks, Louvers, or Windows.
- Stainless Steel is available in the following gauges: US20(.038"), US18(.050"), US16(.062"), US11(.125").
- Aluminum, Brass, and Bronze are available in the following gauges: B&S16(.050"), B&S14(.064"), .125", .188".

Ordering instructions: Specify Rockwood Kickplate Height x Width x Finish Code x Thickness. Add Any Options such as B3E.

- Weight: Metal 8" x 34" = 4.0 lbs., Plastic 8" x 34" = 1.9 lbs.

ROCKWOOD

U. L. Listed Flush and Surface Bolts

#550 and #555 flush bolts are listed for use on A, B, C, D, and E labeled metal doors. Standard rod length is 12". Other lengths are available to order. #554 rabbet piece is designed to fill the mortise gap in rabbeted doors when using our #555. Rabbeted strikes and guides are quoted on request.

#557 flush bolt is U.L. listed for all types of labeled wood fire doors. Door strength is maintained by a reinforcing plate. Simple installation instructions are enclosed in each box. Please specify if door thickness is other than 1 3/4".

#580 and #581 heavy duty surface bolts are U. L. listed for use on the inactive leaf of a pair of labeled fire doors. The bolt is 1/4" thick x 3/4" wide with 1 3/16" throw. It is packed with both top and bottom strike and ms and sms. Sex bolts available, please specify when ordering.

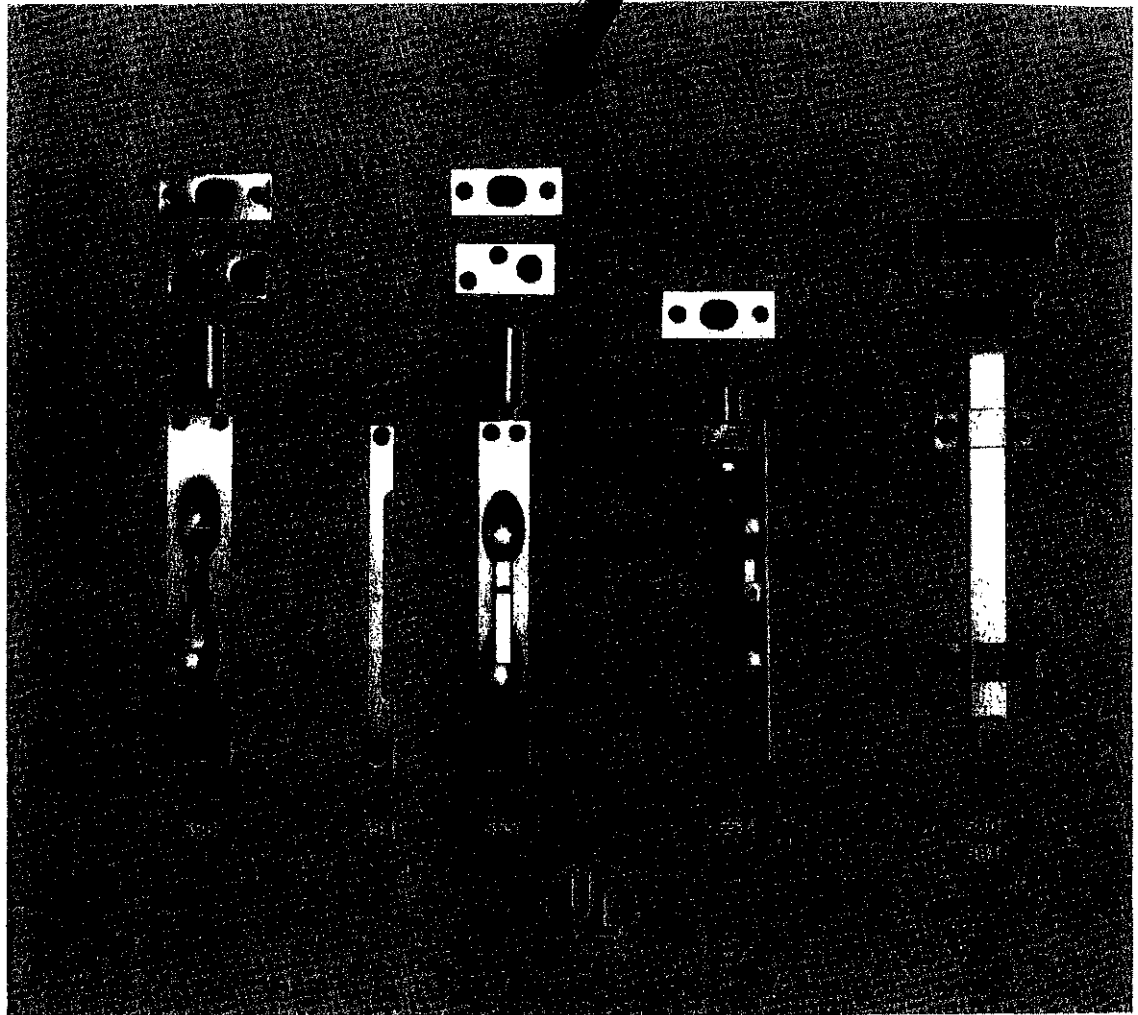

No.	Size	Finishes	Weight	ANSI
550	6 3/4" x 1 1/4"	all architectural	1.7 lbs./2	*****
554	6 3/4" x 1/2"	all architectural	4.1 lbs./10	w/555 L14101
555	6 3/4" x 1"	all architectural	1.5 lbs./2	L14251,L14081
557	6 3/4" x 1"	all architectural	1.7 lbs./2	*****
580	8" bolt	zinc, bronze, chrome, brass	5.3 lbs./5	L84161
581	12" bolt	zinc, bronze, chrome	6.8 lbs./5	*****

ROCKWOOD

1600 Series Coordinators

This non-handed coordinator (with companion filler) is designed to become an integral part of the door frame and when painted with the frame becomes virtually invisible. It is engineered to prevent damage in case of abnormal force against the door that is held open. Stock sizes available for quick shipment are #1660 (60" opening), #1672 (72" opening), and #1696 (96" opening).

Fillers are usually supplied pre-cut from the factory. Note: If "S" dimension is other than 1/2", advise the factory.

The 1600 Series coordinators are manufactured in three different housing lengths to coordinate the full range of door sizes:

- **1600 Series**—for jamb opening widths (A + B dimension) from 54" through 96". E dimension, 52".
- **NX1600 Series**—for jamb opening widths (A + B dimension) from 44" through 76". E dimension, 42".
- **L1600 Series**—for unusual widths and special conditions (minimum jamb opening: 66"). E dimension, 60".

Determining Coordinator Item Number:

Active door widths A plus inactive door width B equals the last two or three digits of all 1600 Series coordinator item numbers. See examples at bottom right.

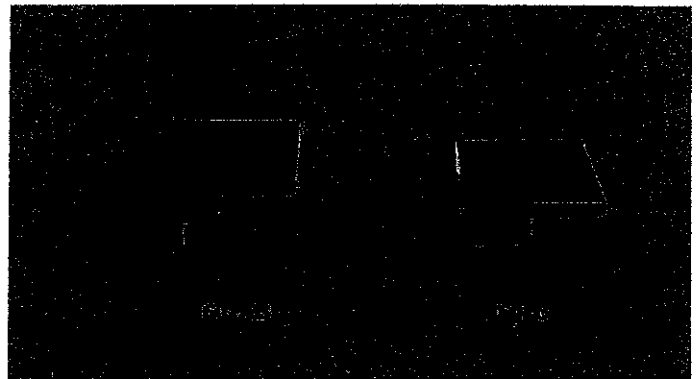
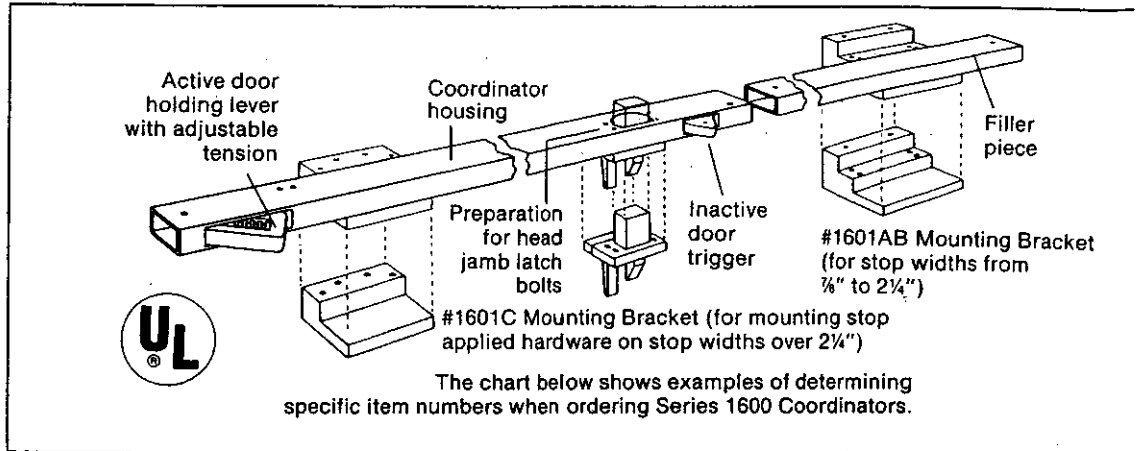

Carry Bars

#1100 carry bars are recommended for use on all openings with astragals except when the inactive door is equipped with automatic flush bolts. Carry bars are available in standard architectural finishes as well as prime coat steel.

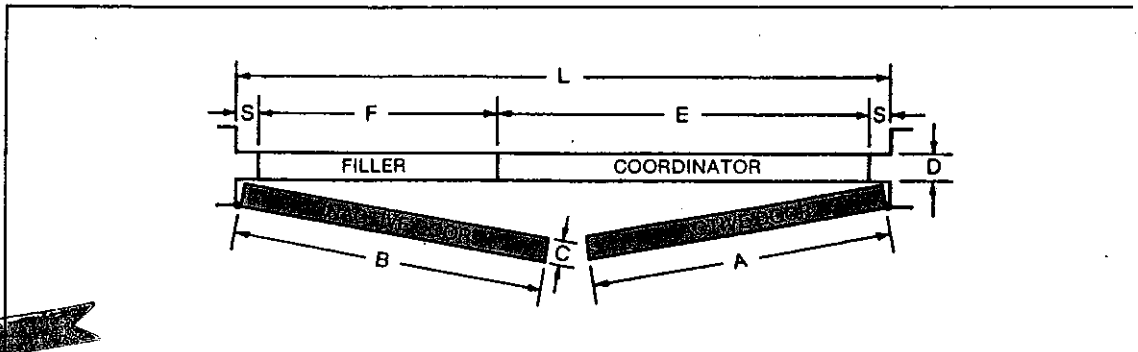

Mounting Brackets

#1601AB and #1601C mounting brackets are used for stop applied hardware. Their use prevents the inadvertent disabling of the coordinator by fasteners passing through the housing.

Range of Sizes	Series No.	Door Leaf Active (Dim. A)	Widths Inactive (Dim. B)	Sum of Dim. A + B	Item No. Equals Sum A + B
54" thru 96" (Dim. A + B)	16	36" 42"	36" 18"	72" 60"	1672 1660
44" thru 76" (Dim. A + B)	NX16	24" 36"	24" 12"	48" 48"	NX1648 NX1648
66" (Min. jamb opening) or greater	L16	54" 52"	42" 52"	96" 104"	L1696 L16104

ROCKWOOD

1842/1942 Automatic Flush Bolts

The #1842 is U.L. listed for use on the inactive leaf of a pair of A, B, C, D, and E labeled metal doors. The #1942 is U.L. listed for use on the inactive leaf of a pair of B, C, D, and E labeled wood covered composite doors. The patented non-handed cam triggering device is the heart of this smooth-acting mechanism; only five pounds of force is required to drive a pair of bolts allowing door closing devices to perform at maximum efficiency. An override feature prevents damage to doors or bolts should the bolt heads be prevented from penetrating either the top or bottom strikes. The bolts are adjustable for unusual clearance or conditions and have a thermal lock that automatically locks the inactive door under high heat conditions due to fire. Sold in pairs.

1845/1945 Combination Flush Bolts

The combination flush bolt uses one automatic flush bolt for the bottom of the door and a constant self-latching flush bolt for the top of the door. When the active leaf is opened, the bottom automatic flush bolt is opened. However the inactive leaf stays latched at the top until it is manually released by depressing the plunger on the bolt face. The top bolt engages each time the inactive door is closed. The #1845 is U.L. listed for use on A, B, C, D, and E labeled metal doors. The #1945 is U.L. listed for use on B, C, D, and E labeled wood covered composite doors. Sold in sets.

Dust Proof Strike

#1880 dust proof strike is designed specifically for use with our automatic flush bolts. Use it wherever dirt clogging a strike hole is a problem.

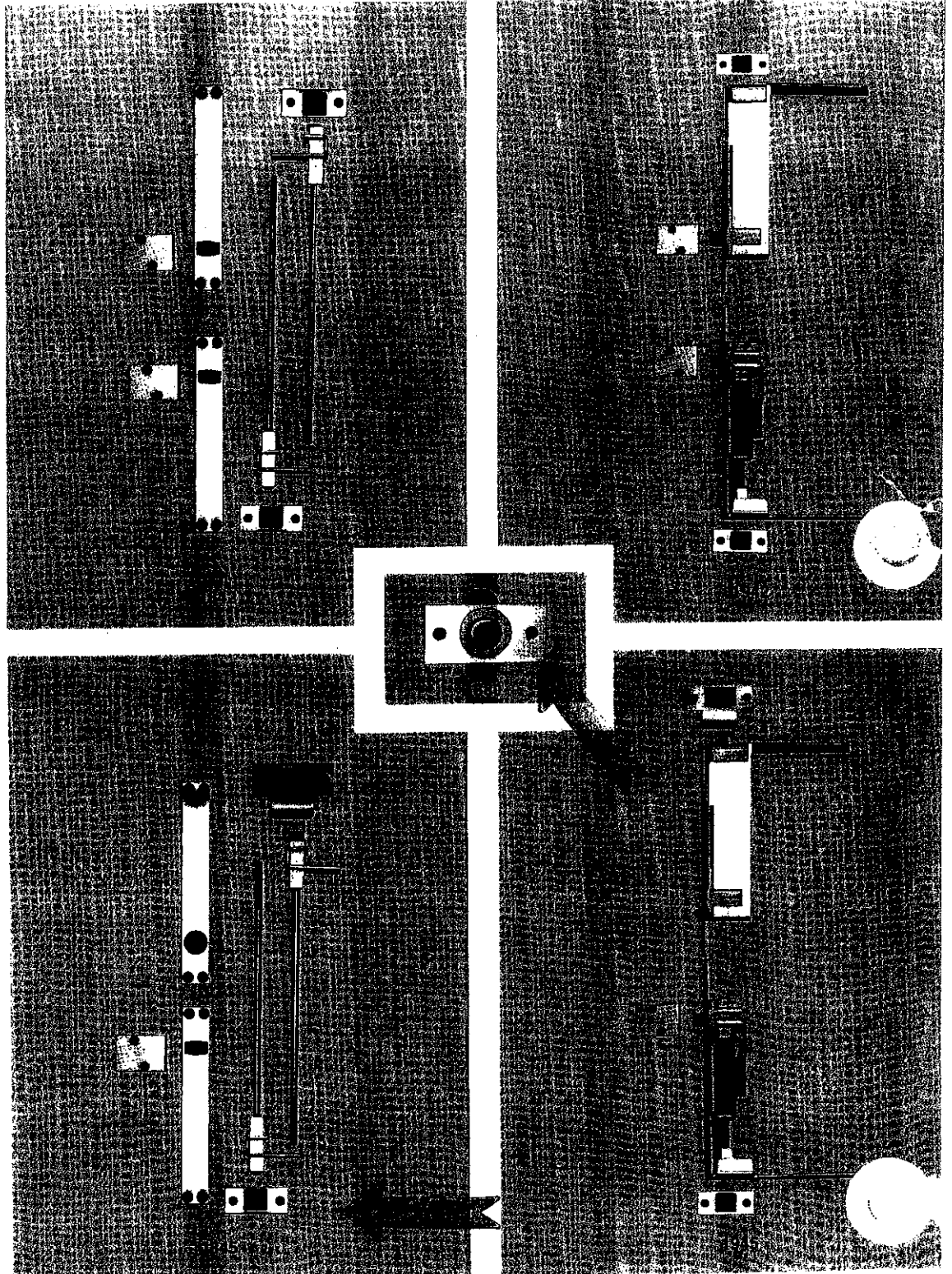

ROCKWOOD

Gate Latch, Door Guard & Silencers

Our #600 and #602 secret gate latch is single acting, reversible and supplied with a dummy knob.

Our #603 and #604 security door guards are easier to use than a chain door guard and eliminates the marring of the door frame caused by chain door guards.

The #605 edge guard is designed to protect the door or frame from marring when used in conjunction with a #603 or 604 door guard.

The #608 and #609 are rubber door silencers for metal and wood frames respectively.

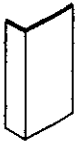

605



608



609

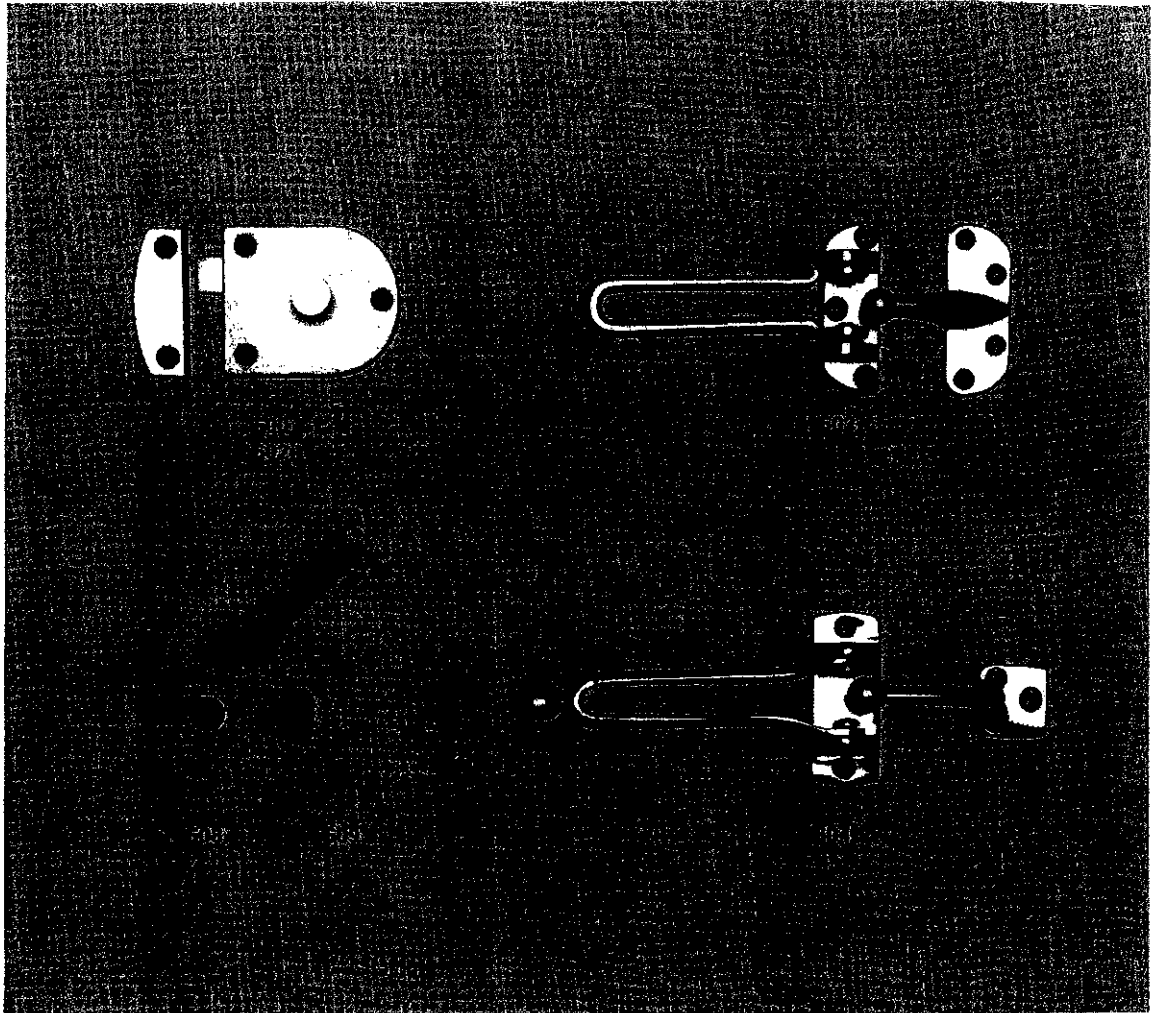

No.	Material	Size	Finishes	Weight	ANSI
600	Aluminum	Case: 2" x 2 3/4"	Sprayed Aluminum	1.5 lbs./6	*****
		Strike: 2" x 2 3/4"	Brass, Bronze, Black		
602	Brass	Case: 2" x 2 3/4"	Dull Brass, Bronze	3.4 lbs./6	*****
		Strike: 2" x 2 3/4"	Dull Chrome		
603	Aluminum	Jamb Plate: 29/32" x 2 1/2"	Dull Chrome	4.2 lbs./10	L33042
		Strike Plate: 31/32" x 2 1/2"	Polished Brass, Antique Brass		
604	Brass	Jamb Plate: 1 1/16" x 29/16"	Polished Brass	4.4 lbs./10	L13042
		Strike Plate: 1 1/16" x 1 1/16"	Dull Chrome		
605	Brass	1 1/8" x 1" x 1/2" return	same as above	0.3 lbs./10	*****
608	Gray Rubber	1/2" diameter x 5/8"		1.3 lbs./500	L03011
609	Gray Rubber	3/8" x 3/4"		1.3 lbs./500	L03021

ROCKWOOD

Wall Bumpers

#400 - #405 feature a solid forged brass housing with a concealed in the bumper attachment. The backplate fully distributes the impact of the door to prevent damage to the wall.

#406 - #411 are wrought preassembled wall bumpers with concealed-in-the-bumper fastening. All of these Rockwood wall bumpers feature a non-yellowing low durometer rubber bumper that softly cushions the door knob. And the metal backplate is designed to distribute the impact of door contact to protect the wall surface.

See page F7 for Poly Pack box quantities.

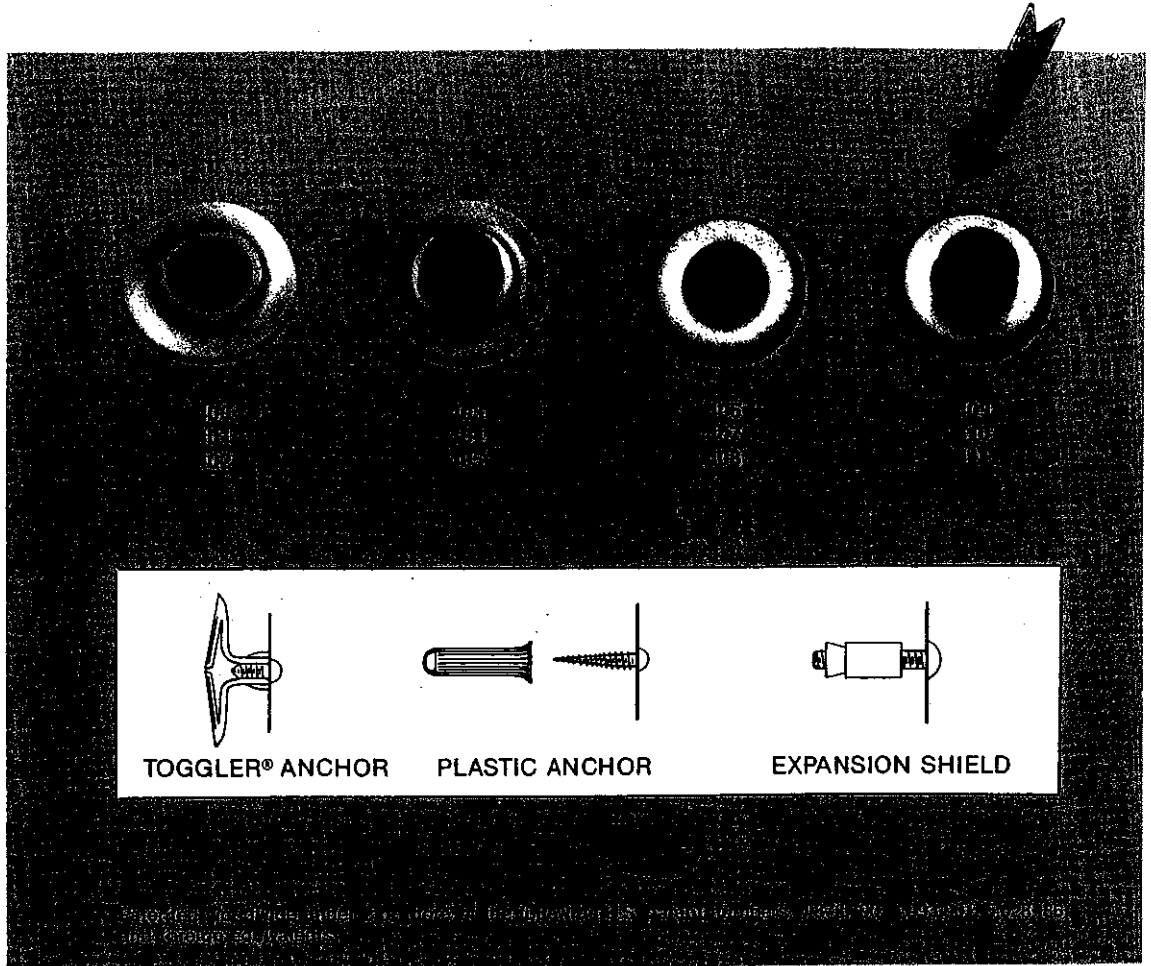

No.	Bumper	Fastener	Size	Weight	ANSI
400	convex	sms and Toggler®	2 1/8" diameter	3.3 lbs./10	L12101
401	convex	ws and anchor	3/4" projection	3.3 lbs./10	L12101
402	convex	ms and exp. shield		3.3 lbs./10	L12101
403	concave	sms and Toggler®		3.3 lbs./10	L12251
404	concave	ws and anchor		3.3 lbs./10	L12251
405	concave	ms and exp. shield		3.3 lbs./10	L12251
406	convex	sms and Toggler®	2 1/8" diameter	1.8 lbs./10	L22101, L52101
407	convex	ws and anchor	3/4" projection	1.8 lbs./10	L22101, L52101
408	convex	ms and exp. shield		1.8 lbs./10	L22101, L52101
409	concave	sms and Toggler®		1.8 lbs./10	L22251, L52251
410	concave	ws and anchor		1.8 lbs./10	L22251, L52251
411	concave	ms and exp. shield		1.8 lbs./10	L22251, L52251

Push Plates

Push plates are available in all architectural finishes, clear plastic and Westinghouse Micarta® laminate plastic. The most popular variations and sizes are shown on this page, but any size may be obtained by special order. Push plates are supplied with phillips oval head stainless steel sheet metal screws, plated to match. #70, #71 and #75 have four beveled edges; #73 and #74 have square edges on the sides and rounded edges on top and bottom, with four beveled edges available as a no cost option.

Standard sizes:

- A = 3" x 12"
- B = 3½" x 15"
- C = 4" x 16"
- E = 6" x 16"
- F = 8" x 16"

To order, specify plate number followed by size designation and finish, i.e. 70B US32D or for non-standard size 70 (width x height) and finish.

OPTIONAL FEATURES:

Adhesive mounting. Specify push plate number "x scotch mount." The push plate will have a 1/16" thick double face foam tape applied to the back side and will have no screw holes.

Engraving. On plates 4" wide or wider it is possible to engrave "PUSH", "PULL", "MEN" or "WOMEN". Please indicate the copy you require and see page A12 for standard engraving location.

Cylinder and turn knob cutouts. Specify the push plate number "x C/C" for cut for cylinder and "x C/TK" for cut for turn knob. See page A12 for standard locations and sizes.

Rounded corners. Specify plate number "x RC".

Two rounded corners. Specify plate number "x 2RC".

Rounded ends. Specify plate number "x RE".

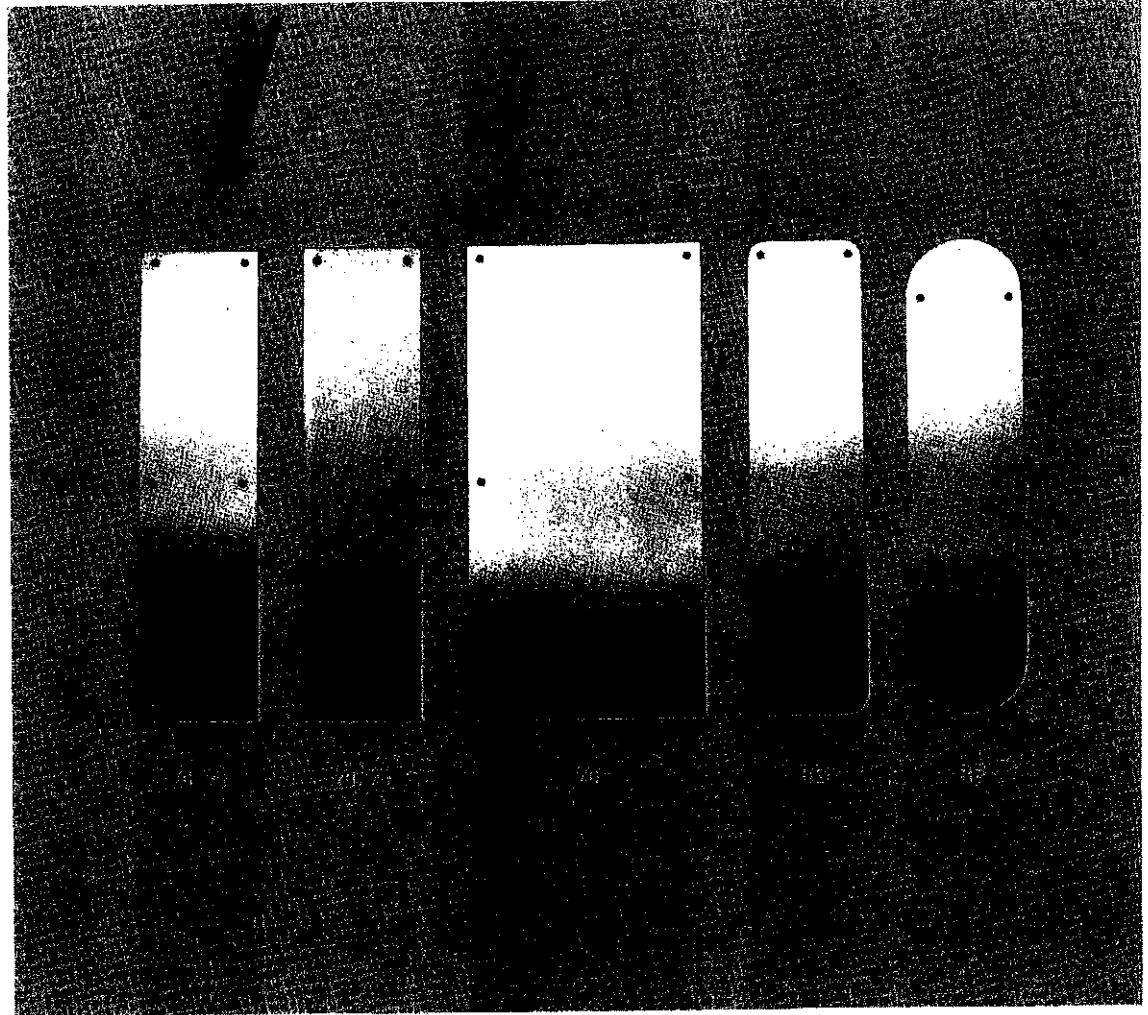

No.	Material	Weight*	ANSI	Suffix For End Modifications
70	.050 wrought	1.0 lbs.	J301	RC = rounded corners
71	.062 wrought	1.2 lbs.	J301	2RC = 2 rounded corners (not shown)
73	.125 wrought	2.2 lbs.	J304	RE = rounded ends
74	.188 wrought	3.8 lbs.	J304	
75	.125 plastic	.5 lbs.	J304	

*For 4" x 16"

BF SERIES DOOR PULLS

This selection of door pulls provides the 2 1/2" clearance we recommend for the upper limb impaired. Push plates are available for door protection as well as for indicating which side of the door to push on.

RECOMMENDED LOCATIONS ON DOOR:

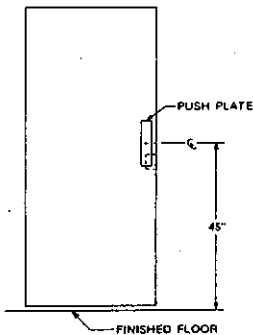
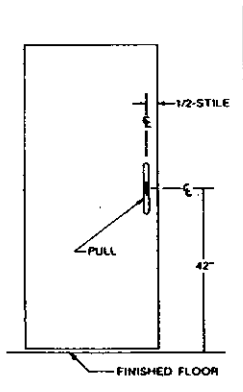

See standards quoted
on back 4.13.9

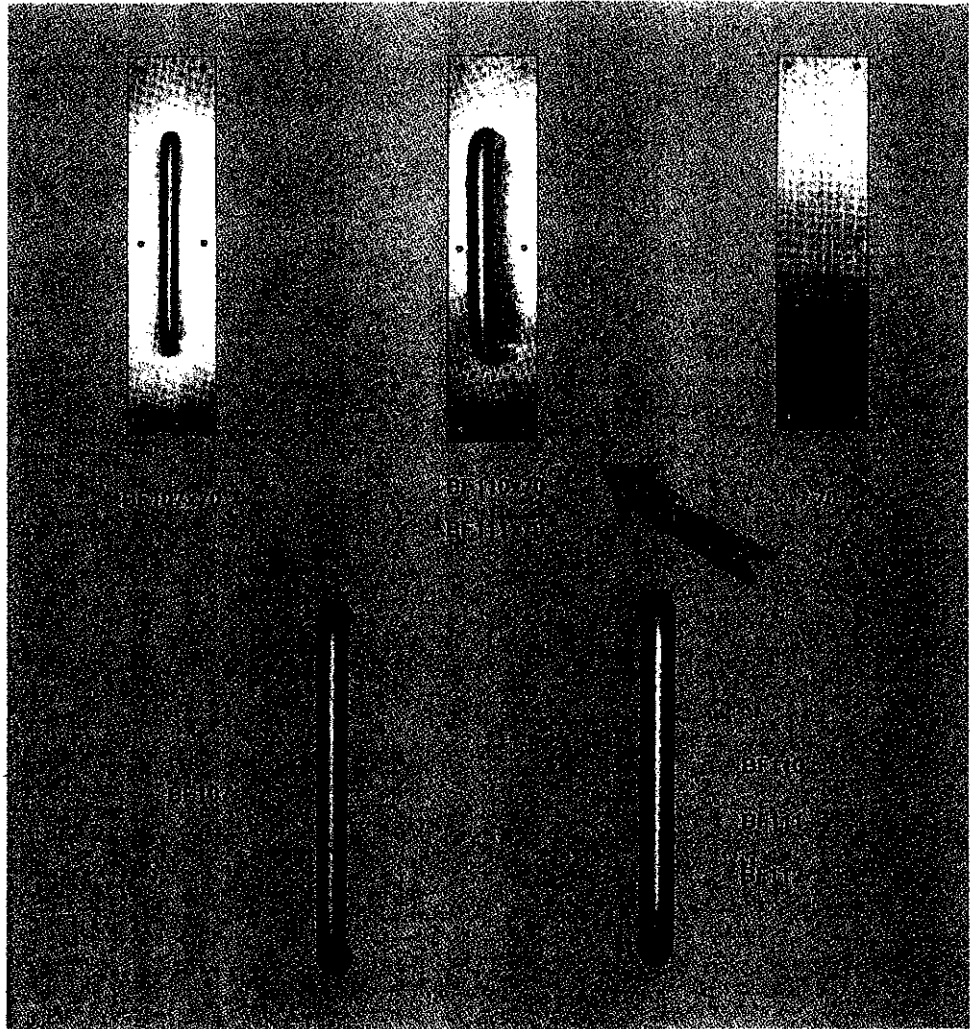

No.	Material	CTC	Overall	Projection	Clearance	Base
BF107	3/4" diameter	8"	8 3/4"	3 1/4"	2 1/2"	3/4"
BF110	1" diameter	8"	9"	3 1/2"	2 1/2"	1"
BF111	1" diameter	10"	11"	3 1/2"	2 1/2"	1"
BF112	1" diameter	12"	13"	3 1/2"	2 1/2"	1"

BF690 SERIES TACTILE SIGNAGE

BF690M BF690W BF690R
10 1/2" high 12" high 12" high

Economical molded plastic sign is adhesive mounted in blue with raised letters and braille translation. Offers complete compliance in an inexpensive sign.

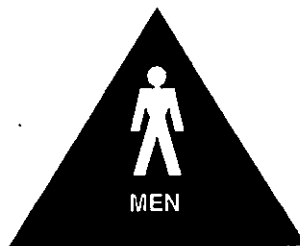

BF690M



BF690W



BF690R

1-800-328-0953

Sill Protection

WEATHERSTRIPS & THRESHOLDS

M15A
M15C
M15D
M15G

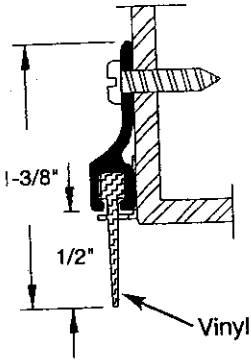

M35A
M35C
M35D
M35G

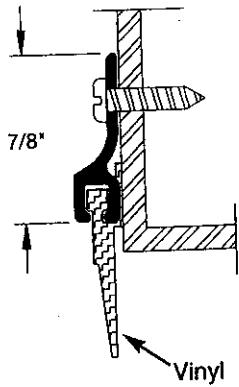

323A
323B
323C
323D
323G

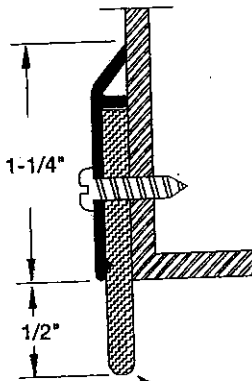

362A
362B
362C
362D
362G

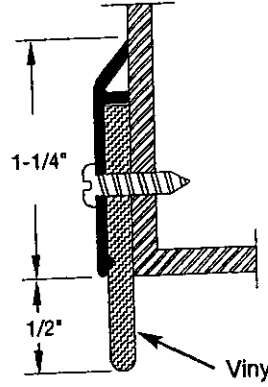

377C
377D
377G

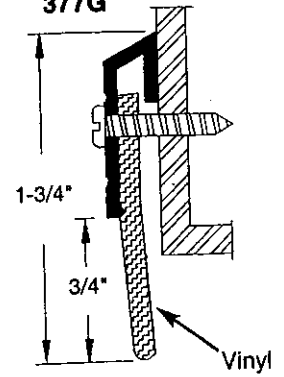

DB469C
DB469D
DB469G

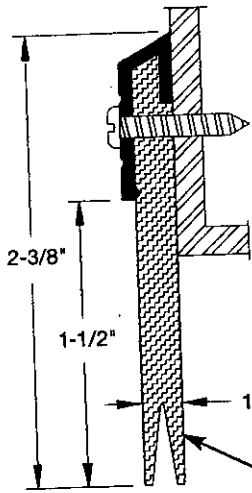

602C
602D
602G

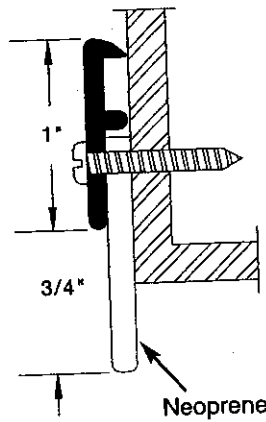

603C
603D
603G

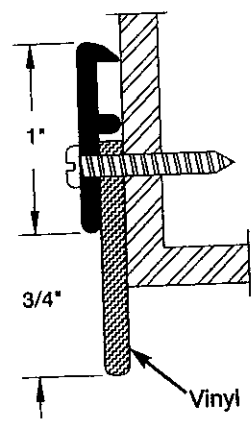

772A
772B
772C
772D
772G

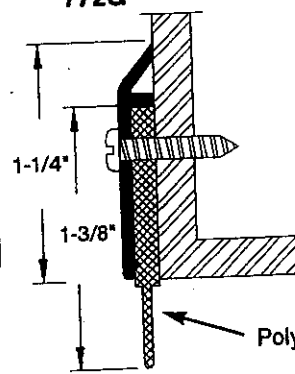

773A
773C
773D
773G

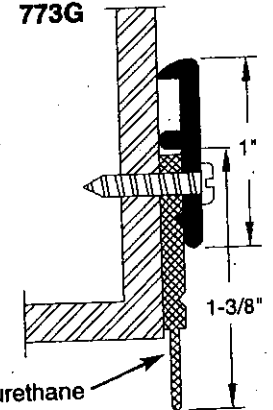

805A
805C
805D
805G

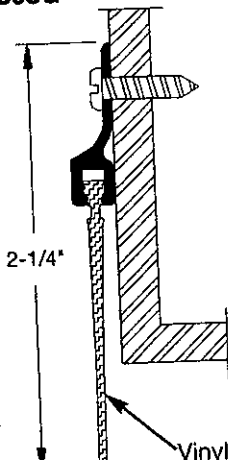

806A
806C
806D
806G

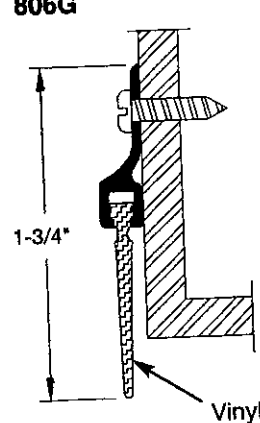

810C
810D
810G

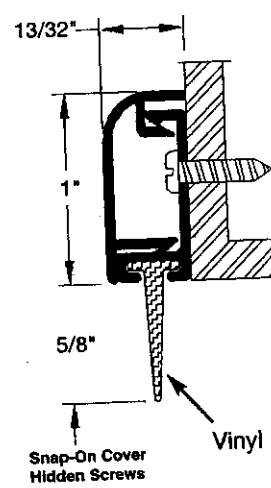

825A
825C
825D
825G

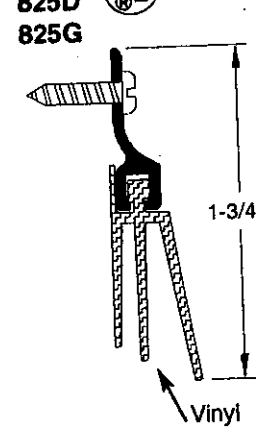

967C
967D

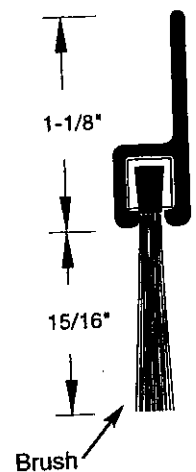

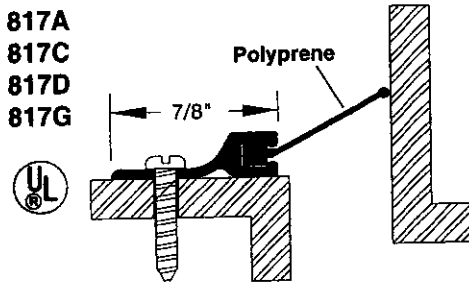
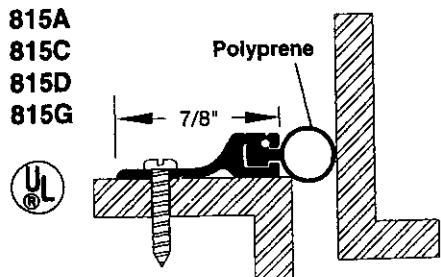
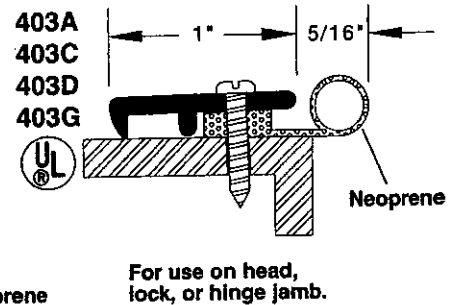
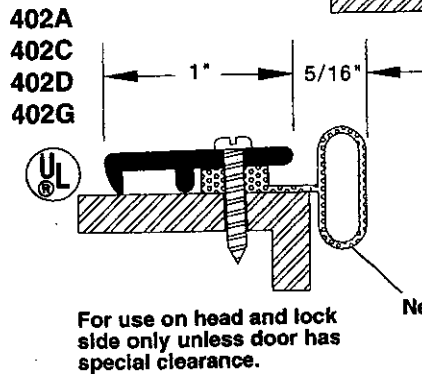
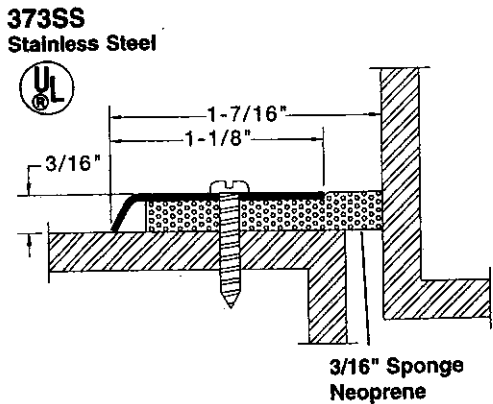
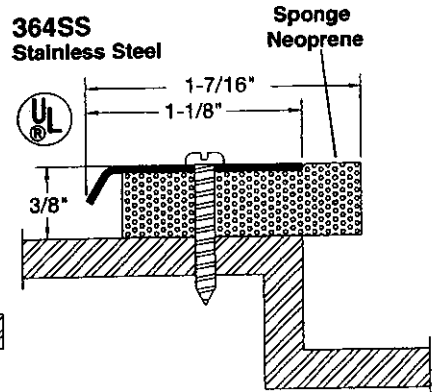
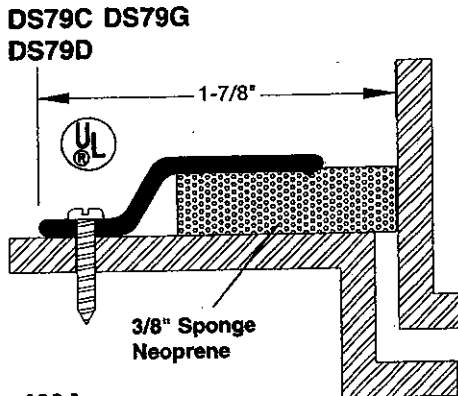
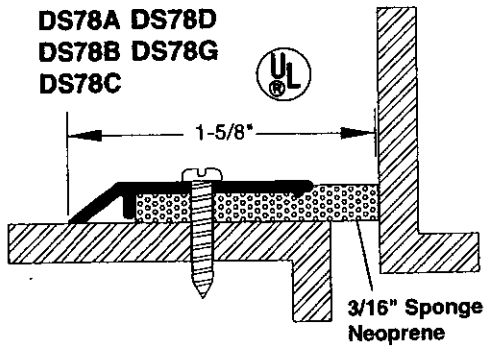
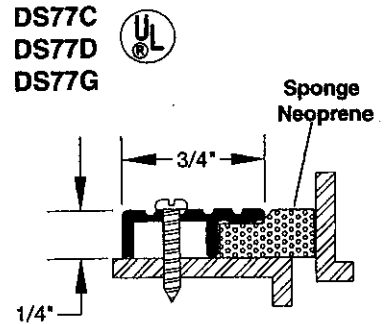
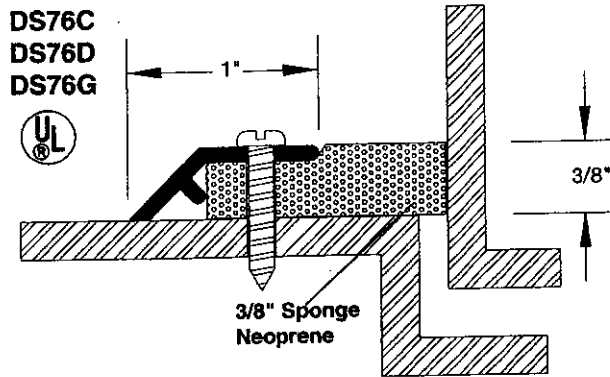
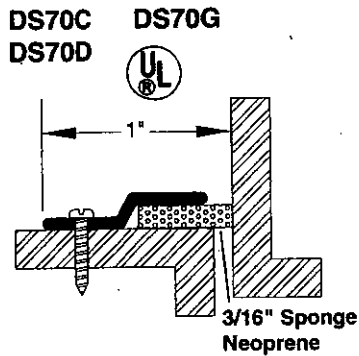
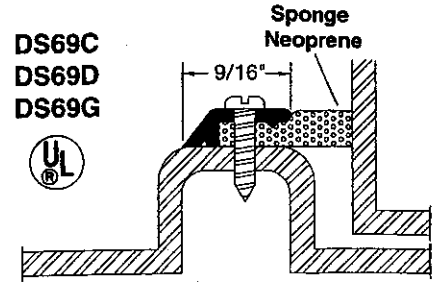
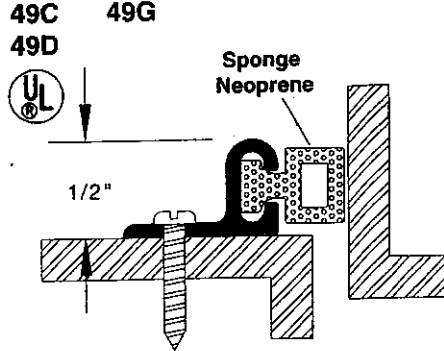
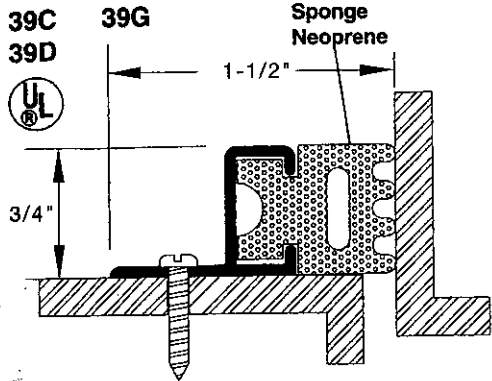

Finish Designations:

A	Aluminum mill finish
B	Architectural bronze (brass)
C	Clear anodized aluminum
D	Dark bronze anodized aluminum
G	Gold anodized aluminum

Saddle Thresholds

S225A

S225B

S225D

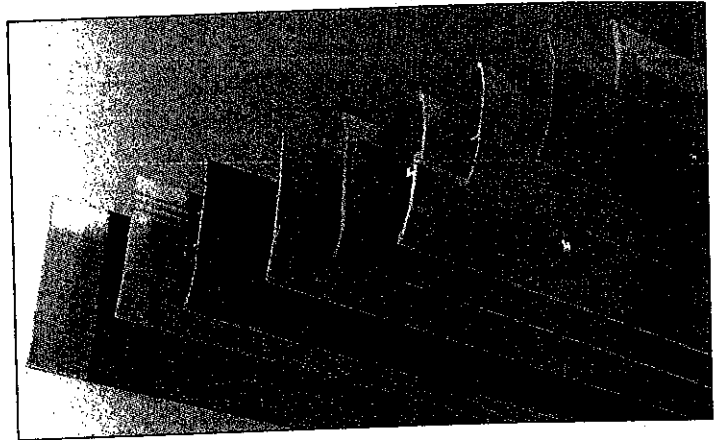
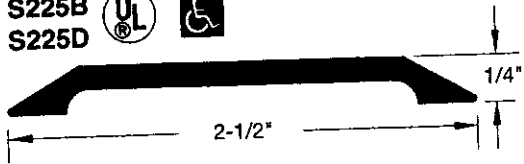

S263A

S263B

S263D

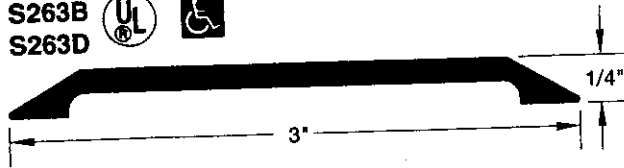

S404A

S404B

S404D

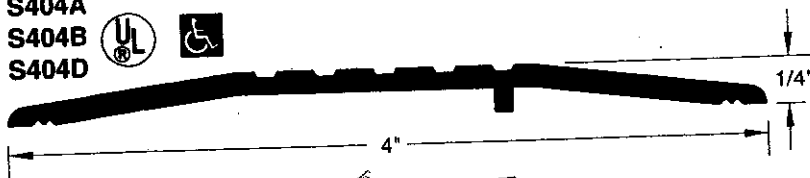

S405A

S405D

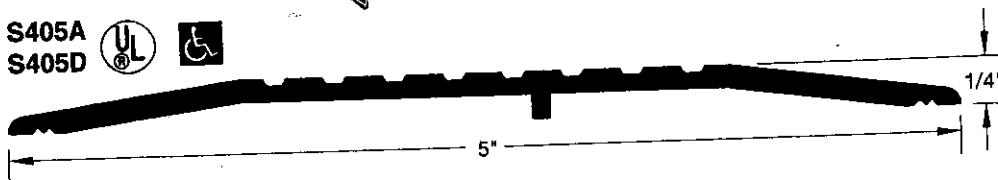

S803A

S803D

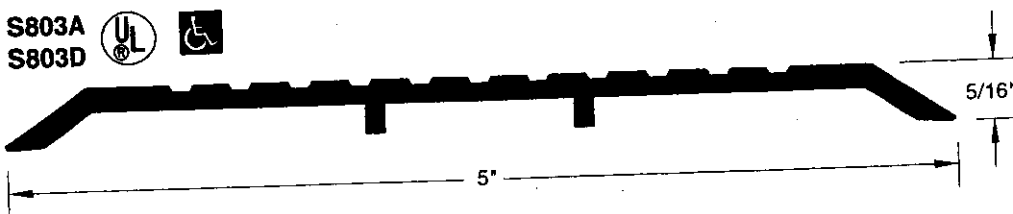

S406A

S406D

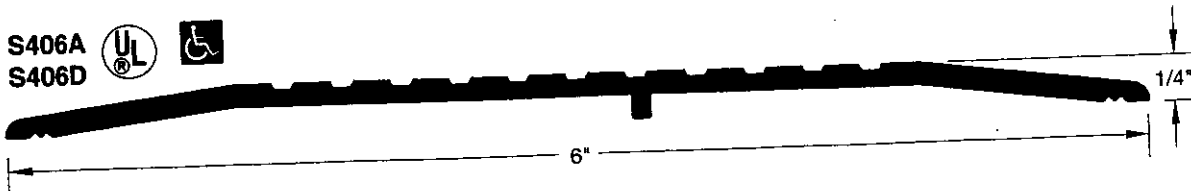

S407A

S407B

S407D

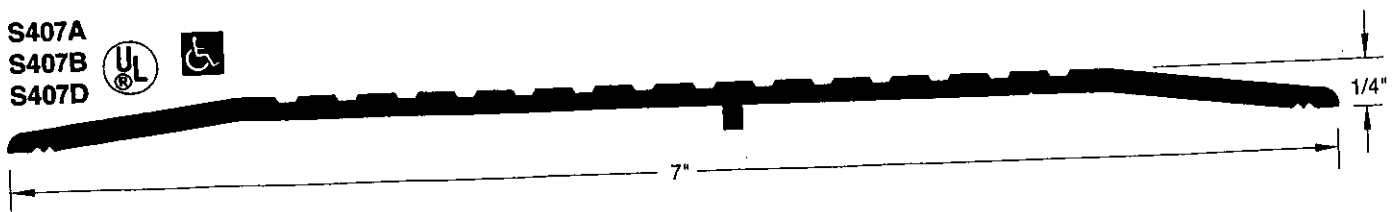

Finish Designations:

- A Aluminum mill finish
- B Architectural bronze (brass)
- D Dark bronze anodized aluminum
- PG Perfect Grit abrasive

S483A S483B S483D

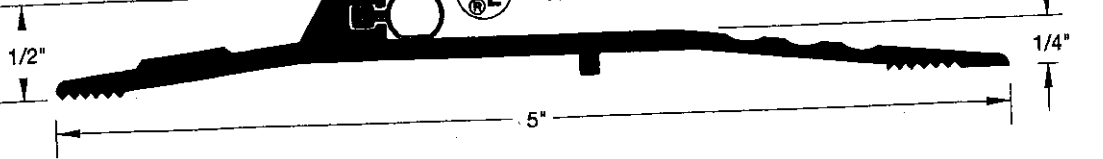

INSERT OPTIONS FOR S483 AND S257

- U — polyurethane
- V — vinyl
- PR — polypropylene

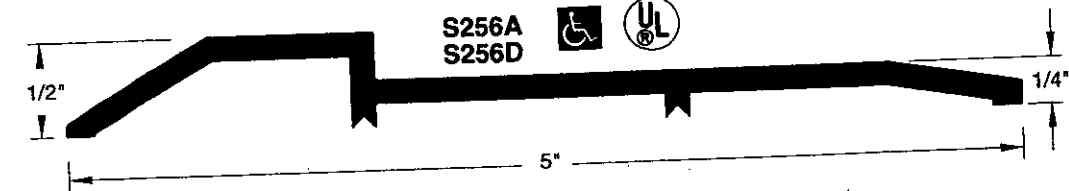
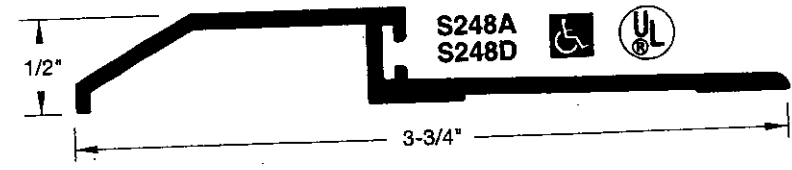
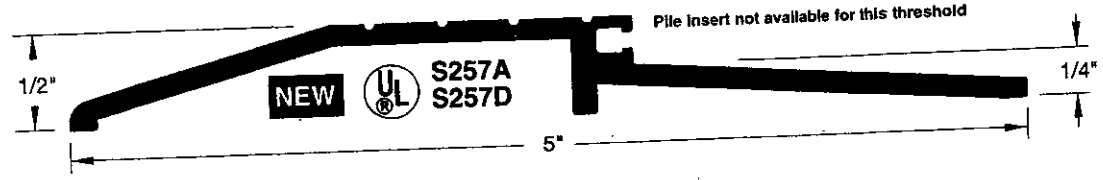

Finish Designations:

- A Aluminum mill finish
- B Architectural bronze (brass)
- D Dark bronze anodized aluminum
- PG Perfect Grit abrasive

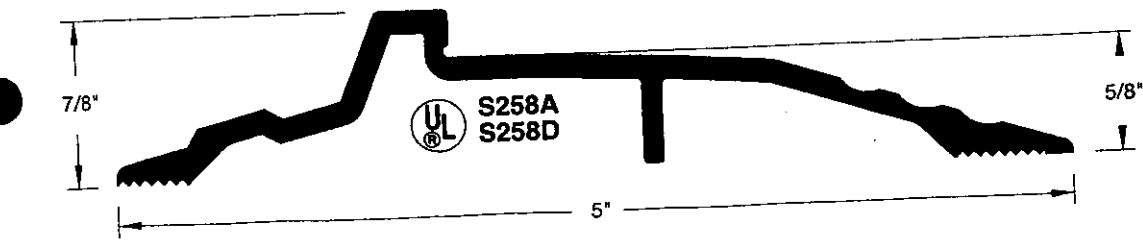
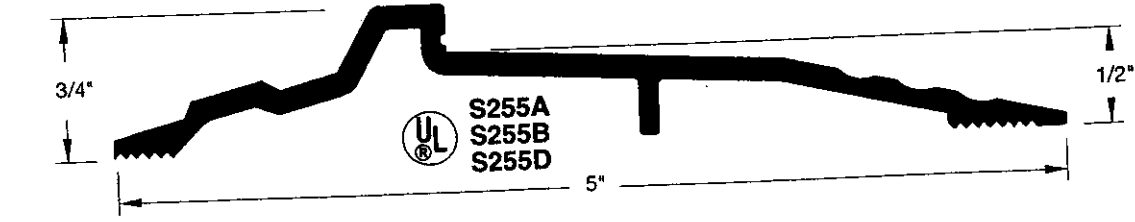
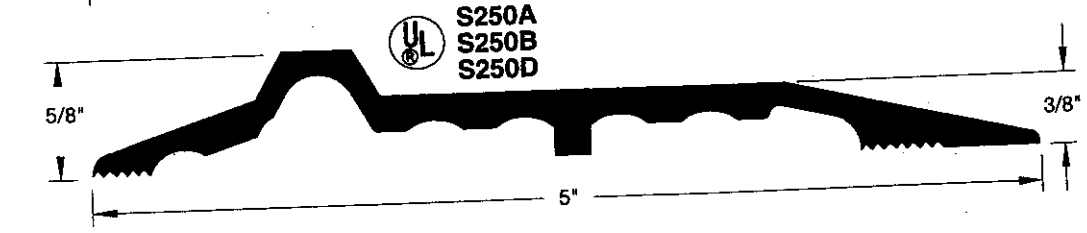

**SECTION 100040
ACCESS DOORS AND FRAMES**

PART 1 - GENERAL

1.1 SUMMARY

- A. Section Includes:
 - 1. Access doors and frames for walls and ceilings.

1.2 ACTION SUBMITTALS

- A. Product Data: For each type of product.
 - 1. Include construction details, fire ratings, materials, individual components and profiles, and finishes.
- B. Shop Drawings:
 - 1. Include plans, elevations, sections, details, and attachments to other work.
 - 2. Detail fabrication and installation of access doors and frames for each type of substrate.
- C. Samples: For each door face material, at least 3 by 5 inches in size, in specified finish.
- D. Product Schedule: Provide complete access door and frame schedule, including types, locations, sizes, latching or locking provisions, and other data pertinent to installation.

PART 2 - PRODUCTS

2.1 PERFORMANCE REQUIREMENTS

- A. Fire-Rated Access Doors and Frames: Units complying with NFPA 80 that are identical to access door and frame assemblies tested for fire-test-response characteristics according to the following test method and that are listed and labeled by UL or another testing and inspecting agency acceptable to authorities having jurisdiction:
 - 1. NFPA 252 or UL 10B for fire-rated access door assemblies installed vertically.
 - 2. NFPA 288 for fire-rated access door assemblies installed horizontally.

2.2 ACCESS DOORS AND FRAMES FOR WALLS AND CEILINGS

- A. Manufacturers: Subject to compliance with requirements, available manufacturers offering products that may be incorporated into the Work include, but are not limited to, the following:
 - 1. Access Panel Solutions.

2. Acudor Products, Inc.
3. Alfab, Inc.
4. Babcock-Davis.
5. Cendrex Inc.
6. Elmdor/Stoneman Manufacturing Co.; Div. of Acorn Engineering Co.
7. Jensen Industries; Div. of Broan-Nutone, LLC.
8. J. L. Industries, Inc.; Div. of Activar Construction Products Group.
9. Karp Associates, Inc.
10. Larsen's Manufacturing Company.
11. Maxam Metal Products Limited.
12. Metropolitan Door Industries Corp.
13. MIFAB, Inc.
14. Milcor Inc.
15. Nystrom, Inc.
16. Williams Bros. Corporation of America (The).

B. Source Limitations: Obtain each type of access door and frame from single source from single manufacturer.

C. Flush Access Doors with Concealed Flanges:

1. Assembly Description: Fabricate door to fit flush to frame. Provide frame with concealed flange installation.
2. Locations: Wall and ceiling.
3. Door Size: Refer to Mechanical Drawings or as required for each access application.
4. Uncoated Steel Sheet for Door: Nominal 0.060 inch, 16 gage.
 - a. Finish: Factory finish. Color to match adjacent finish color.
5. Frame Material: Same material and thickness as door.
6. Hinges: Manufacturer's standard.
7. Hardware: Lock.

D. Fire-Rated, Flush Access Doors with Concealed Flanges:

1. Assembly Description: Fabricate door to fit flush to frame, with a core of mineral-fiber insulation enclosed in sheet metal. Provide self-latching door with automatic closer and interior latch release. Provide frame with concealed flange installation.
2. Locations: Wall.
3. Fire-Resistance Rating: Not less than that of adjacent construction.
4. Temperature-Rise Rating: 450 deg F at the end of 30 minutes.
5. Uncoated Steel Sheet for Door: Nominal 0.036 inch, 20 gage.
 - a. Finish: Factory finish. Color to match adjacent finish color.
6. Frame Material: Same material, thickness, and finish as door.
7. Hinges: Manufacturer's standard.
8. Hardware: Lock.

E. Hardware:

1. Lock: Cylinder.

2.3 MATERIALS

- A. Steel Plates, Shapes, and Bars: ASTM A 36.
- B. Steel Sheet: Uncoated or electrolytic zinc coated, ASTM A 879, with cold-rolled steel sheet substrate complying with ASTM A 1008, Commercial Steel (CS), exposed.
- C. Frame Anchors: Same type as door face.
- D. Inserts, Bolts, and Anchor Fasteners: Hot-dip galvanized steel according to ASTM A 153 or ASTM F 2329.

2.4 FABRICATION

- A. General: Provide access door and frame assemblies manufactured as integral units ready for installation.
- B. Metal Surfaces: For metal surfaces exposed to view in the completed Work, provide materials with smooth, flat surfaces without blemishes. Do not use materials with exposed pitting, seam marks, roller marks, rolled trade names, or roughness.
- C. Doors and Frames: Grind exposed welds smooth and flush with adjacent surfaces. Furnish attachment devices and fasteners of type required to secure access doors to types of supports indicated.
 1. Provide mounting holes in frames for attachment of units to metal framing.
 2. Provide mounting holes in frame for attachment of masonry anchors.
- D. Latching Mechanisms: Furnish number required to hold doors in flush, smooth plane when closed.
 1. For cylinder locks, furnish two keys per lock and key all locks alike.

2.5 FINISHES

- A. Comply with NAAMM's "Metal Finishes Manual for Architectural and Metal Products" for recommendations for applying and designating finishes.
- B. Protect mechanical finishes on exposed surfaces from damage by applying a strippable, temporary protective covering before shipping.
- C. Appearance of Finished Work: Noticeable variations in same piece are not acceptable. Variations in appearance of adjoining components are acceptable if they are within the range of approved Samples and are assembled or installed to minimize contrast.
- D. Steel Finishes:

1. Factory Prime: Apply manufacturer's standard, fast-curing, lead- and chromate-free, universal primer immediately after surface preparation and pretreatment.
2. Factory Finish: Immediately after cleaning and pretreating, apply manufacturer's standard two-coat, baked-on finish consisting of prime coat and thermosetting topcoat, with a minimum dry-film thickness of 1 mil for topcoat.

PART 3 - EXECUTION

3.1 EXAMINATION

- A. Examine substrates for compliance with requirements for installation tolerances and other conditions affecting performance of the Work.
- B. Proceed with installation only after unsatisfactory conditions have been corrected.

3.2 INSTALLATION

- A. Comply with manufacturer's written instructions for installing access doors and frames.
- B. Install doors flush with adjacent finish surfaces or recessed to receive finish material.

3.3 ADJUSTING

- A. Adjust doors and hardware, after installation, for proper operation.
- B. Remove and replace doors and frames that are warped, bowed, or otherwise damaged.

** END OF SECTION **

**SECTION 10050
WINDOW LIGHT KITS**

PART 1 - GENERAL

1.1 WINDOW LIGHT KITS

- A. Light kits are required in all occupied office spaces and should be equipped with School Guard Glass.

**** END OF SECTION ****

SECTION 100060

SECTIONAL DOORS

PART 1 - GENERAL

1.1 SUMMARY

A. Section includes:

1. Insulated Sectional Overhead Doors.
2. Electric Operators and Controls.
3. Operating Hardware, tracks, and support.

B. Related Requirements:

1. Section 24 - Cast-In-Place Concrete: Prepared opening in concrete. Execution requirements for placement of anchors in concrete wall construction.
2. Section 24 - Unit Masonry Assemblies: Prepared opening in masonry. Execution requirements for placement of anchors in masonry wall construction.
3. Section 24 - Joint Sealants: Perimeter sealant and backup materials.
4. Section 10 - Door Hardware: Cylinder locks.
5. Section 24 - High Performance Coatings: Field painting.
6. Section 18 - Raceway and Boxes: Empty conduit from control station to door operator.
7. Section 18 - Wiring Connections: Electrical service to door operator.

1.2 REFERENCES

- A. ANSI/DASMA 102 - American National Standard Specifications for Sectional Overhead Type Doors.

1.3 DESIGN/PERFORMANCE REQUIREMENTS

- A. Wind Loads: Design and size components to withstand loads caused by pressure and suction of wind acting normal to plane of wall as calculated in accordance with applicable code.
 1. Design pressure of 27 lb/sq ft acting inward and outward.
- B. Wiring Connections: Requirements for electrical characteristics.
 1. 115 volts, single phase, 60 Hz.
- C. Single-Source Responsibility: Provide doors, tracks, motors, and accessories from one manufacturer for each type of door. Provide secondary components from source acceptable to manufacturer of primary components.

1.4 ACTION SUBMITTALS

- A. Product Data: Manufacturer's data sheets on each product to be used, including:
 - 1. Preparation instructions and recommendations.
 - 2. Storage and handling requirements and recommendations.
 - 3. Installation methods.
- B. Shop Drawings: Indicate plans and elevations including opening dimensions and required tolerances, connection details, anchorage spacing, hardware locations, and installation details.
- C. Manufacturer's Certificates: Certify products meet or exceed specified requirements.
- D. Operation and Maintenance Data.

1.5 QUALITY ASSURANCE

- A. Manufacturer Qualifications: Company specializing in manufacturing products specified in this section with minimum five years documented experience.
- B. Installer Qualifications: Authorized representative of the manufacturer with minimum five years documented experience.
- C. Products Requiring Electrical Connection: Listed and classified by Underwriters Laboratories, Inc. acceptable to authority having jurisdiction as suitable for purpose specified.

1.6 DELIVERY, STORAGE, AND HANDLING

- A. Store products in manufacturer's unopened labeled packaging until ready for installation.
- B. Protect materials from exposure to moisture until ready for installation.
- C. Store materials in a dry, ventilated weathertight location.

1.7 PROJECT CONDITIONS

- A. Pre-Installation Conference: Convene a pre-installation conference just prior to commencement of field operations, to establish procedures to maintain optimum working conditions and to coordinate this work with related and adjacent work.

1.8 WARRANTY

- A. Warranty: Manufacturer's limited door and operators System warranty for 10 year against delamination of polyurethane foam from steel face and all other components for 3 years or 20,000 cycles, whichever comes first.

PART 2 - PRODUCTS

2.1 MANUFACTURERS

- A. Acceptable Manufacturer: Overhead Door Corp., 2501 S. State Hwy. 121, Suite 200, Lewisville, TX 75067. ASD. Tel. Toll Free: (800) 275-3290. Phone: (469) 549-7100. Fax: (972) 906-1499. Web Site: www.overheaddoor.com. E-mail: info@overheaddoor.com.
- B. Requests for substitutions will be considered in accordance with provisions of Section 012500.

2.2 INSULATED SECTIONAL OVERHEAD DOORS

- A. Insulated Steel Sectional **Overhead Doors: 599 Series Thermacore** Insulated Steel Doors by Overhead Door Corporation. Units shall have the following characteristics:
 - 1. Door Assembly: Metal/foam/metal sandwich panel construction, with PVC thermal break and weather-tight ship-lap meeting joints.
 - a. Panel Thickness: 2 inches.
 - b. Exterior Surface: Flush, textured.
 - c. Exterior Steel: .015 inch, hot-dipped galvanized.
 - d. End Stiles: 16 gauge with thermal break.
 - e. Spring Counterbalance: Sized to weight of the door, with a helically wound, oil tempered torsion spring mounted on a steel shaft; cable drum of diecast aluminum with high strength galvanized aircraft cable. Sized with a minimum 7 to 1 safety factor.
 - 1. High cycle spring: 50,000 cycles.
 - f. Insulation: CFC-free and HCFC-free polyurethane, fully encapsulated.
 - g. Thermal Values: R-value of 17.50; U-value of 0.057.
 - h. Air Infiltration: 0.08 cfm at 15 mph; 0.08 cfm at 25 mph.
 - i. High-Usage Package: Provide high-usage package.
 - j. Full Glazed Aluminum Sash Panels:
 - 1. 1/2 inch Low E Insulated glazing.
 - 2. Finish and Color: Two coat baked-on polyester.
 - a. Interior color, tan.
 - b. Exterior color, tan.
 - 3. Windload Design: Provide to meet the Design/Performance requirements specified.
 - 4. Hardware: Galvanized steel hinges and fixtures. Ball bearing rollers with hardened steel races.
 - 5. Lock:
 - a. Keyed lock with interlock switch for automatic operator.
 - 6. Weatherstripping:

- a. EPDM bulb-type strip at bottom section.
 - b. Flexible Jamb seals.
 - c. Flexible Header seal.
7. Track: Provide track as recommended by manufacturer to suit loading required and clearances available.
- a. Size: 2 inch.
 - b. Type: Standard lift, low headroom.
8. Electric Motor Operation: Provide UL listed 1/2 HP electric operator, to move door in either direction at not less than 2/3 foot nor more than 1 foot per second. Operator shall meet UL325/2010 requirements for continuous monitoring of safety devices.
- a. Entrapment Protection: Required for momentary contact.
 - 1. Electric sensing edge monitored to meet UL 325/2010.
 - 2. Photoelectric sensors monitored to meet UL 325/2010.
 - b. Operator Controls:
 - 1. Push-button and key operated control stations with open, close, and stop buttons.
 - 2. Flush mounting.
 - 3. Both interior and exterior location.

PART 3 - EXECUTION

3.1 EXAMINATION

- A. Do not begin installation until openings have been properly prepared.
- B. Verify wall openings are ready to receive work and opening dimensions and tolerances are within specified limits.
- C. Verify electric power is available and of correct characteristics.
- D. If preparation is the responsibility of another installer, notify Owner of unsatisfactory preparation before proceeding.

3.2 PREPARATION

- A. Clean surfaces thoroughly prior to installation.
- B. Prepare surfaces using the methods recommended by the manufacturer for achieving the best result for the substrate under the project conditions.

3.3 INSTALLATION

- A. Install overhead doors and track in accordance with approved shop drawings and the manufacturer's printed instructions.
- B. Coordinate installation with adjacent work to ensure proper clearances and allow for maintenance.
- C. Anchor assembly to wall construction and building framing without distortion or stress.
- D. Securely brace door tracks suspended from structure. Secure tracks to structural members only.
- E. Fit and align door assembly including hardware.
- F. Coordinate installation of electrical service. Complete power and control wiring from disconnect to unit components.

3.4 CLEANING AND ADJUSTING

- A. Adjust door assembly to smooth operation and in full contact with weatherstripping.
- B. Clean doors, frames and glass.
- C. Remove temporary labels and visible markings.

3.5 PROTECTION

- A. Do not permit construction traffic through overhead door openings after adjustment and cleaning.
- B. Protect installed products until completion of project.
- C. Touch-up, damaged coatings and finishes and repair minor damage before Substantial Completion.

** END OF SECTION **

**SECTION 100070
ALUMINUM FRAMED
ENTRANCES AND STOREFRONTS**

PART 1 - GENERAL

1.1 RELATED DOCUMENTS

- A. Drawings and general provisions of the Contract, including General and Supplementary Conditions and Division 01 Specification Sections, apply to this Section.

1.2 SUMMARY

- A. Section Includes:
 - 1. Exterior and interior manual swing entrance doors and door frame units.

1.3 DEFINITIONS

- A. ADA/ABA Accessibility Guidelines: U.S. Architectural & Transportation Barriers Compliance Board's "Americans with Disability Act (ADA) and Architectural Barriers Act (ABA) Accessibility Guidelines for Buildings and Facilities."

1.4 PERFORMANCE REQUIREMENTS

- A. General Performance: Aluminum framed systems shall withstand the effects of the following performance requirements without exceeding performance criteria or failure due to defective manufacture, fabrication, installation, or other defects in construction:
 - 1. Movements of supporting structure indicated on Drawings including, but not limited to, story drift and deflection from uniformly distributed and concentrated live loads.
 - 2. Dimensional tolerances of building frame and other adjacent construction.
 - 3. Failure includes the following:
 - a. Deflection exceeding specified limits.
 - b. Thermal stresses transferring to building structure.
 - c. Framing members transferring stresses, including those caused by thermal and structural movements to glazing.
 - d. Glazing-to-glazing contact.
 - e. Noise or vibration created by wind and by thermal and structural movements.
 - f. Loosening or weakening of fasteners, attachments, and other components.
 - g. Sealant failure.
 - h. Failure of operating units.
- B. Delegated Design: Design aluminum framed systems, including comprehensive engineering analysis by a qualified professional engineer, using performance requirements and design criteria indicated.

- C. Structural Loads:
1. Wind Loads:
 2. Seismic Loads:
 3. Blast Loads:
- D. Deflection of Framing Members:
1. Deflection Normal to Wall Plane: Limited to 1/175 of clear span for spans up to 13 feet 6 inches and to 1/240 of clear span plus 1/4 inch for spans greater than 13 feet 6 inches or an amount that restricts edge deflection of individual glazing lites to 3/4 inch, whichever is less.
 2. Deflection Parallel to Glazing Plane: Limited to L/360 of clear span or 1/8 inch, whichever is smaller.
- E. Structural Test Performance: Provide aluminum framed systems tested according to ASTM E 330 as follows:
1. When tested at positive and negative wind-load design pressures, systems do not evidence deflection exceeding specified limits.
 2. When tested at 150 percent of positive and negative wind-load design pressures, systems, including anchorage, do not evidence material failures, structural distress, and permanent deformation of main framing members exceeding 0.2 percent of span.
 3. Test Durations: As required by design wind velocity, but not fewer than 10 seconds.
- F. Story Drift: Provide aluminum framed systems that accommodate design displacement of adjacent stories indicated.
1. Design Displacement:
 2. Test Performance: Meet criteria for passing, based on building occupancy type, when tested according to AAMA 501.4 at design displacement and 1.5 times design displacement.
- G. Air Infiltration: Provide aluminum framed systems with maximum air leakage through fixed glazing and framing areas of 0.06 cfm/sq. ft. of fixed wall area when tested according to ASTM E 283 at a minimum static-air-pressure difference of 1.57 lbf/sq. ft.
- H. Water Penetration under Static Pressure: Provide aluminum framed systems that do not evidence water penetration through fixed glazing and framing areas when tested according to ASTM E 331 at a minimum static-air-pressure difference of 20 percent of positive wind-load design pressure, but not less than 6.24 lbf/sq. ft.
- I. Water Penetration under Dynamic Pressure: Provide aluminum framed systems that do not evidence water leakage through fixed glazing and framing areas when tested according to AAMA 501.1 under dynamic pressure equal to 20 percent of positive wind-load design pressure, but not less than 6.24 lbf/sq. ft.
1. Maximum Water Leakage: No uncontrolled water penetrating aluminum framed systems or water appearing on systems' normally exposed interior surfaces from sources other than condensation. Water leakage does not include water controlled by flashing and

gutters that is drained to exterior and water that cannot damage adjacent materials or finishes.

- J. Thermal Movements: Provide aluminum framed systems that allow for thermal movements resulting from the following maximum change (range) in ambient and surface temperatures. Base engineering calculation on surface temperatures of materials due to both solar heat gain and nighttime-sky heat loss.
 - 1. Temperature Change (Range): 120 deg F, ambient; 180 deg F, material surfaces.
 - 2. Test Performance: No buckling; stress on glass; sealant failure; excess stress on framing, anchors, and fasteners; or reduction of performance when tested according to AAMA 501.5.
 - a. High Exterior Ambient-Air Temperature: That which produces an exterior metal-surface temperature of 180 deg F.
 - b. Low Exterior Ambient-Air Temperature: 0 deg F.
 - 3. Interior Ambient-Air Temperature: 75 deg F.
- K. Condensation Resistance: Provide aluminum framed systems with fixed glazing and framing areas having condensation-resistance factor (CRF) of not less than 53 when tested according to AAMA 1503.
- L. Thermal Conductance: Provide aluminum framed systems with fixed glazing and framing areas having an average U-factor of not more than 0.57 Btu/sq. ft. x h x deg F when tested according to AAMA 1503.
- M. Sound Transmission: Provide aluminum framed systems with fixed glazing and framing areas having the following sound-transmission characteristics:
 - 1. Sound Transmission Class (STC): Minimum 30 STC when tested for laboratory sound transmission loss according to ASTM E 90 and determined by ASTM E 413.
- N. Structural Sealant: Capable of withstanding tensile and shear stresses imposed by aluminum framed systems without failing adhesively or cohesively. When tested for preconstruction adhesion and compatibility, cohesive failure of sealant shall occur before adhesive failure.
 - 1. Adhesive failure occurs when sealant pulls away from substrate cleanly, leaving no sealant material behind.
 - 2. Cohesive failure occurs when sealant breaks or tears within itself but does not separate from each substrate because sealant-to-substrate bond strength exceeds sealant's internal strength.
- O. Structural-Sealant Joints: Designed to produce tensile or shear stress of less than 20 psi.

1.5 ACTION SUBMITTALS

- A. Product Data: For each type of product indicated. Include construction details, material descriptions, dimensions of individual components and profiles, and finishes for aluminum framed systems.

- B. Shop Drawings: For aluminum framed systems. Include plans, elevations, sections, details, and attachments to other work.
 - 1. Include details of provisions for system expansion and contraction and for drainage of moisture in the system to the exterior.
 - 2. For entrance doors, include hardware schedule and indicate operating hardware types, functions, quantities, and locations.
- C. Samples for Verification: For each type of exposed finish required, in Manufacturer's standard sizes.
- D. Fabrication Sample: Of each vertical-to-horizontal intersection of aluminum framed systems, made from 12-inch lengths of full-size components and showing details of the following:
 - 1. Joinery, including concealed welds.
 - 2. Anchorage.
 - 3. Expansion provisions.
 - 4. Glazing.
 - 5. Flashing and drainage.
- E. Other Action Submittals:
 - 1. Entrance Door Hardware Schedule: Prepared by or under the supervision of supplier, detailing fabrication and assembly of entrance door hardware, as well as procedures and diagrams. Coordinate final entrance door hardware schedule with doors, frames, and related work to ensure proper size, thickness, hand, function, and finish of entrance door hardware.
- F. Delegated Design Submittal: For aluminum framed systems indicated to comply with performance requirements and design criteria, including analysis data signed and sealed by the qualified professional engineer responsible for their preparation.
 - 1. Detail fabrication and assembly of aluminum framed systems.
 - 2. Include design calculations.

1.6 INFORMATIONAL SUBMITTALS

- A. Qualification Data: For qualified Installer and testing agency.
- B. Seismic Qualification Certificates: For aluminum framed systems, accessories, and components, from Manufacturer.
 - 1. Basis for Certification: Indicate whether withstand certification is based on actual test of assembled components or on calculation.
- C. Welding certificates.
- D. Preconstruction Test Reports: For sealant.

- E. Product Test Reports: Based on evaluation of comprehensive tests performed by a qualified testing agency, for aluminum framed systems, indicating compliance with performance requirements.
- F. Source quality-control reports.
- G. Quality Control Program for Structural Sealant Glazed System: Include reports.
- H. Field quality-control reports.
- I. Warranties: Sample of special warranties.

1.7 CLOSEOUT SUBMITTALS

- A. Maintenance Data: For aluminum framed systems to include in maintenance manuals.

1.8 QUALITY ASSURANCE

- A. Installer Qualifications: Manufacturer's authorized representative who is trained and approved for installation of units required for this Project.
- B. Testing Agency Qualifications: Qualified according to ASTM E 699 for testing indicated.
- C. Engineering Responsibility: Prepare data for aluminum framed systems, including Shop Drawings, based on testing and engineering analysis of Manufacturer's standard units in systems similar to those indicated for this Project.
- D. Quality Control Program for Structural Sealant Glazed System: Develop quality control program specifically for Project. Document quality-control procedures and verify results for aluminum framed systems. Comply with ASTM C 1401 recommendations including, but not limited to, system material-qualification procedures, preconstruction sealant-testing program, procedures for system fabrication and installation, and intervals of reviews and checks.
- E. Product Options: Information on Drawings and in Specifications establishes requirements for systems' aesthetic effects and performance characteristics. Aesthetic effects are indicated by dimensions, arrangements, alignment, and profiles of components and assemblies as they relate to sightlines, to one another, and to adjoining construction. Performance characteristics are indicated by criteria subject to verification by one or more methods including preconstruction testing, field testing, and in-service performance.
 - 1. Do not revise intended aesthetic effects, as judged solely by Owner, except with Owner's approval. If revisions are proposed, submit comprehensive explanatory data to Owner for review.
- F. Pre-construction Sealant Testing: For structural sealant glazed systems, perform sealant Manufacturer's standard tests for compatibility with and adhesion of each material that will come in contact with sealants and each condition required by aluminum framed systems.
 - 1. Test a minimum five samples each of metal, glazing, and other material.
 - 2. Prepare samples using techniques and primers required for installed systems.

3. For materials that fail tests, determine corrective measures necessary to prepare each material to ensure compatibility with and adhesion of sealants including, but not limited to, specially formulated primers. After performing these corrective measures on the minimum number of samples required for each material, retest materials.
- G. Accessible Entrances: Comply with applicable provisions in the U.S. Architectural & Transportation Barriers Compliance Board's ADA-ABA Accessibility Guidelines and ICC/ANSI A117.1.
 - H. Source Limitations for Aluminum framed Systems: Obtain from single source from single Manufacturer.
 - I. Structural Sealant Glazing: Comply with ASTM C 1401, "Guide for Structural Sealant Glazing" for design and installation of structural-sealant-glazed systems.
 - J. Structural Sealant Joints: Design reviewed and approved by structural-sealant Manufacturer.
 - K. Welding Qualifications: Qualify procedures and personnel according to AWS D1.2, "Structural Welding Code - Aluminum."
 - L. Mockups: Build mockups to verify selections made under sample submittals and to demonstrate aesthetic effects and set quality standards for fabrication and installation.
 1. Build mockup of typical wall area.
 2. Field testing shall be performed on mockups according to requirements in "Field Quality Control" Article.
 3. Approval of mockups does not constitute approval of deviations from the Contract Documents contained in mockups unless Owner specifically approves such deviations in writing.
 4. Approved mockups may become part of the completed Work if undisturbed at time of Substantial Completion.
 - M. Pre-installation Conference: Conduct conference at Project site.

1.9 PROJECT CONDITIONS

- A. Field Measurements: Verify actual locations of structural supports for aluminum framed systems by field measurements before fabrication and indicate measurements on Shop Drawings.

1.10 WARRANTY

- A. Special Warranty: Manufacturer's standard form in which Manufacturer agrees to repair or replace components of aluminum framed systems that do not comply with requirements or that fail in materials or workmanship within specified warranty period.
 1. Failures include, but are not limited to, the following:
 - a. Structural failures including, but not limited to, excessive deflection.
 - b. Noise or vibration caused by thermal movements.

- c. Deterioration of metals, metal finishes, and other materials beyond normal weathering.
 - d. Adhesive or cohesive sealant failures.
 - e. Water leakage through fixed glazing and framing areas.
 - f. Failure of operating components.
2. Warranty Period: **5 years** from date of Substantial Completion.

1.11 MAINTENANCE SERVICE

A. Entrance Door Hardware:

1. Maintenance Tools and Instructions: Furnish a complete set of specialized tools and maintenance instructions as needed for Owner's continued adjustment, maintenance, and removal and replacement of entrance door hardware.
2. Initial Maintenance Service: Beginning at Substantial Completion, provide six months' full maintenance by skilled employees of entrance door hardware Installer. Include quarterly preventive maintenance, repair or replacement of worn or defective components, lubrication, cleaning, and adjusting as required for proper entrance door hardware operation at rated speed and capacity. Provide parts and supplies the same as those used in the manufacture and installation of original equipment.

PART 2 - PRODUCTS

2.1 MANUFACTURERS

- A. Basis-of-Design Storefront Product: Subject to compliance with requirements, provide **YKK AP America Inc YES 45 TU** Series Storefront or comparable product by one of the following:
1. Kawneer.
 2. US Aluminum, Division of CR Lawrence.
 3. Old Castle Building Envelope.
- B. Basis-of-Design Entrance Product: Subject to compliance with requirements, provide **YKK AP America Inc 35D** Series Medium Stile Swing Doors with 10" Bottom Rail (coordinate medium stile with hardware supplied) or comparable product by one of the following:
1. Kawneer.
 2. US Aluminum, Division of CR Lawrence.
 3. Old Castle Building Envelope.

2.2 MATERIALS

- A. Aluminum: Alloy and temper recommended by Manufacturer for type of use and finish indicated.
1. Sheet and Plate: ASTM B 209.
 2. Extruded Bars, Rods, Profiles, and Tubes: ASTM B 221.

3. Extruded Structural Pipe and Tubes: ASTM B 429.
 4. Structural Profiles: ASTM B 308.
 5. Welding Rods and Bare Electrodes: AWS A5.10.
- B. Steel Reinforcement: Manufacturer's standard zinc-rich, corrosion-resistant primer, complying with SSPC-PS Guide No. 12.00; applied immediately after surface preparation and pretreatment. Select surface preparation methods according to recommendations in SSPC-SP COM and prepare surfaces according to applicable SSPC standard.
1. Structural Shapes, Plates, and Bars: ASTM A 36.
 2. Cold-Rolled Sheet and Strip: ASTM A 1008.
 3. Hot-Rolled Sheet and Strip: ASTM A 1011.

2.3 FRAMING SYSTEMS

- A. Framing Members: Manufacturer's standard extruded-aluminum framing members of thickness required and reinforced as required to support imposed loads.
1. Construction: Thermally broken.
 2. Glazing System: Retained mechanically with gaskets on four sides.
 3. Glazing Plane: Center.
- B. Brackets and Reinforcements: Manufacturer's standard high strength aluminum with non-staining, nonferrous shims for aligning system components.
- C. Fasteners and Accessories: Manufacturer's standard corrosion-resistant, non-staining, non-bleeding fasteners and accessories compatible with adjacent materials.
1. Use self-locking devices where fasteners are subject to loosening or turning out from thermal and structural movements, wind loads, or vibration.
 2. Reinforce members as required to receive fastener threads.
 3. Use exposed fasteners with countersunk Phillips screw heads, finished to match framing system, fabricated from stainless steel.
- D. Concrete and Masonry Inserts: Hot-dip galvanized cast-iron, malleable-iron, or steel inserts, complying with ASTM A 123 or ASTM A 153.
- E. Concealed Flashing: Dead-soft, 0.018-inch thick stainless steel, ASTM A 240 of type recommended by Manufacturer.
- F. Shim Supports: Custom continuous pre-finished aluminum shim supports attached to aluminum frame to retain secondary sealant application specified in Section 079200. Shim support to be mechanically attached to main aluminum frame member at head, jambs, and sill on all aluminum frames to support secondary compression sealant.
- G. Framing System Gaskets and Sealants: Manufacturer's standard, recommended by Manufacturer for joint type.
1. Sealants used inside the weatherproofing system shall have a VOC content of 250 g/L or less when calculated according to 40 CFR 59, Subpart D (EPA Method 24).

2. Sealants used inside the weatherproofing system shall comply with the testing and product requirements of the California Department of Health Services' "Standard Practice for the Testing of Volatile Organic Emissions from Various Sources Using Small-Scale Environmental Chambers."

2.4 GLAZING SYSTEMS

- A. Glazing: As specified in Division 24 Section "Glazing."
- B. Glazing Gaskets: Manufacturer's standard compression types; replaceable, molded or extruded, of profile and hardness required to maintain watertight seal.
- C. Spacers and Setting Blocks: Manufacturer's standard elastomeric type.
- D. Bond Breaker Tape: Manufacturer's standard TFE-fluorocarbon or polyethylene material to which sealants will not develop adhesion.
- E. Glazing Sealants: For structural-sealant-glazed systems, as recommended by Manufacturer for joint type, and as follows:
 1. Structural Sealant: ASTM C 1184, single-component neutral-curing silicone formulation that is compatible with system components with which it comes in contact, specifically formulated and tested for use as structural sealant and approved by a structural-sealant Manufacturer for use in aluminum framed systems indicated.
 - a. Sealants used inside the weatherproofing system shall have a VOC content of 100 g/L or less when calculated according to 40 CFR 59, Subpart D (EPA Method 24).
 - b. Sealants used inside the weatherproofing system shall comply with the testing and product requirements of the California Department of Health Services' "Standard Practice for the Testing of Volatile Organic Emissions from Various Sources Using Small-Scale Environmental Chambers."
 - c. Color: Black.
 2. Weather-seal Sealant: ASTM C 920 for Type S, Grade NS, Class 25, Uses NT, G, A, and O; single-component neutral-curing formulation that is compatible with structural sealant and other system components with which it comes in contact; recommended by structural-sealant, weather-seal-sealant, and aluminum framed-system Manufacturers for this use.
 - a. Sealants used inside the weatherproofing system shall have a VOC content of 250 g/L or less when calculated according to 40 CFR 59, Subpart D (EPA Method 24).
 - b. Sealants used inside the weatherproofing system shall comply with the testing and product requirements of the California Department of Health Services' "Standard Practice for the Testing of Volatile Organic Emissions from Various Sources Using Small-Scale Environmental Chambers."
 - c. Color: Matching structural sealant.

2.5 ENTRANCE DOOR SYSTEMS

- A. Entrance Doors: Manufacturer's standard glazed entrance doors for manual-swing operation.
 - 1. Door Construction: 2-3/8 inch overall thickness, with minimum 0.125 inch thick, extruded-aluminum tubular rail and stile members. Mechanically fasten corners with reinforcing brackets that are deeply penetrated and fillet welded or that incorporate concealed tie rods.
 - a. Thermal Construction: High-performance plastic connectors separate aluminum members exposed to the exterior from members exposed to the interior.
 - 2. Door Design: Medium stile; 3-1/2-inch nominal width.
 - a. Accessible Doors: Smooth surfaced for width of door in area within 10 inches above floor or ground plane.
 - 3. Glazing Stops and Gaskets: Square, snap-on, extruded-aluminum stops and preformed gaskets.
 - a. Provide non-removable glazing stops on outside of door.
- B. Entrance Door Hardware: As specified in Section 10 "Door Hardware."

2.6 ENTRANCE DOOR HARDWARE

- A. General: Provide entrance door hardware and entrance door hardware sets indicated in door and frame schedule.
 - 1. Entrance Door Hardware Sets: Provide quantity, item, size, finish or color indicated.
 - 2. Opening Force Requirements:
 - a. Egress Doors: Not more than 15 lbf to release the latch and not more than 30 lbf to set the door in motion and not more than 15 lbf to open the door to its minimum required width.
 - b. Accessible Interior Doors: Not more than 5 lbf to fully open door.

2.7 STOREFRONT SYSTEM

- A. General: Manufacturer's standard extruded aluminum sections and components for complete storefront system.

2.8 ACCESSORY MATERIALS

- A. Joint Sealants: For installation at perimeter of aluminum framed systems, as specified in Division 24 Section "Joint Sealants."
 - 1. Sealants used inside the weatherproofing system shall have a VOC content of 250 g/L or less when calculated according to 40 CFR 59, Subpart D (EPA Method 24).

2. Sealants used inside the weatherproofing system shall comply with the testing and product requirements of the California Department of Health Services' "Standard Practice for the Testing of Volatile Organic Emissions from Various Sources Using Small-Scale Environmental Chambers."

- B. Bituminous Paint: Cold-applied, asphalt-mastic paint complying with SSPC-Paint 12 requirements except containing no asbestos; formulated for 30-mil thickness per coat.

2.9 FABRICATION

- A. Form or extrude aluminum shapes before finishing.
- B. Weld in concealed locations to greatest extent possible to minimize distortion or discoloration of finish. Remove weld spatter and welding oxides from exposed surfaces by de-scaling or grinding.
- C. Framing Members, General: Fabricate components that, when assembled, have the following characteristics:
 1. Profiles that are sharp, straight, and free of defects or deformations.
 2. Accurately fitted joints with ends coped or mitered.
 3. Means to drain water passing joints, condensation within framing members, and moisture migrating within the system to exterior.
 4. Physical and thermal isolation of glazing from framing members.
 5. Accommodations for thermal and mechanical movements of glazing and framing to maintain required glazing edge clearances.
 6. Provisions for field replacement of glazing from exterior.
 7. Fasteners, anchors, and connection devices that are concealed from view to greatest extent possible.
- D. Mechanically Glazed Framing Members: Fabricate for flush glazing without projecting stops.
- E. Structural Sealant Glazed Framing Members: Include accommodations for using temporary support device to retain glazing in place while structural sealant cures.
- F. Storefront Framing: Fabricate components for assembly using shear block system.
- G. Entrance Door Frames: Reinforce as required to support loads imposed by door operation and for installing entrance door hardware.
 1. At exterior doors, provide compression weather stripping at fixed stops.
 2. At interior doors, provide silencers at stops to prevent metal-to-metal contact. Install three silencers on strike jamb of single-door frames and two silencers on head of frames for pairs of doors.
- H. Entrance Doors: Reinforce doors as required for installing entrance door hardware.
 1. At exterior doors, provide weather sweeps applied to door bottoms.

- I. Entrance Door Hardware Installation: Factory install entrance door hardware to the greatest extent possible. Cut, drill, and tap for factory-installed entrance door hardware before applying finishes.
- J. After fabrication, clearly mark components to identify their locations in Project according to Shop Drawings.

2.10 ALUMINUM FINISHES

- A. **Clear Anodic Finish:** AAMA 611, AA-M12C22A41, Class I, 0.018 mm or thicker.

PART 3 - EXECUTION

3.1 EXAMINATION

- A. Examine areas and conditions, with Installer present, for compliance with requirements for installation tolerances and other conditions affecting performance of the Work.
- B. Proceed with installation only after unsatisfactory conditions have been corrected.

3.2 INSTALLATION

- A. General:
 - 1. Comply with Manufacturer's written instructions.
 - 2. Do not install damaged components.
 - 3. Fit joints to produce hairline joints free of burrs and distortion.

4. Rigidly secure non-movement joints.
5. Install anchors with separators and isolators to prevent metal corrosion and electrolytic deterioration.
6. Seal joints watertight unless otherwise indicated.

B. Metal Protection:

1. Where aluminum will contact dissimilar metals, protect against galvanic action by painting contact surfaces with primer or applying sealant or tape, or by installing nonconductive spacers as recommended by Manufacturer for this purpose.
2. Where aluminum will contact concrete or masonry, protect against corrosion by painting contact surfaces with bituminous paint.

C. Install components to drain water passing joints, condensation occurring within framing members, and moisture migrating within the system to exterior.

D. Set continuous sill members and flashing in full sealant bed as specified in Section 24 Section "Joint Sealants" to produce weather-tight installation.

E. Install components plumb and true in alignment with established lines and grades, and without warp or rack.

F. Install glazing as specified in Section 24 "Glazing."

G. Entrance Doors: Install doors to produce smooth operation and tight fit at contact points.

1. Exterior Doors: Install to produce weather-tight enclosure and tight fit at weather stripping.
2. Field Installed Entrance Door Hardware: Install surface mounted entrance door hardware according to entrance door hardware Manufacturers' written instructions using concealed fasteners to greatest extent possible.

H. Install perimeter joint sealants as specified in Section 24 "Joint Sealants" to produce weather-tight installation.

3.3 ERECTION TOLERANCES

A. Install aluminum framed systems to comply with the following maximum erection tolerances:

1. Location and Plane: Limit variation from true location and plane to 1/8 inch in 12 feet; 1/4 inch over total length.
2. Alignment:
 - a. Where surfaces abut in line, limit offset from true alignment to 1/16 inch.
 - b. Where surfaces meet at corners, limit offset from true alignment to 1/32 inch.

B. Diagonal Measurements: Limit difference between diagonal measurements to 1/8 inch.

3.4 FIELD QUALITY CONTROL

- A. Testing Agency: **Engage** a qualified independent testing and inspecting agency to perform field tests and inspections.
- B. Testing Services: Testing and inspecting of representative areas to determine compliance of installed systems with specified requirements shall take place as follows and in successive phases as indicated on Drawings. Do not proceed with installation of the next area until test results for previously completed areas show compliance with requirements.
 - 1. Air Infiltration: Areas shall be tested for air leakage of 1.5 times the rate specified for laboratory testing under "Performance Requirements" Article, but not more than 0.09 cfm/sq. ft., of fixed wall area when tested according to ASTM E 783 at a minimum static-air-pressure difference of 6.24 lbf/sq. ft.
 - 2. Water Penetration: Areas shall be tested according to ASTM E 1105 at a minimum uniform and cyclic static-air-pressure difference of 0.67 times the static-air-pressure difference specified for laboratory testing under "Performance Requirements" Article, but not less than 4.18 lbf/sq. ft., and shall not evidence water penetration.
 - 3. Water Spray Test: Before installation of interior finishes has begun, a minimum area of 75 feet by 1 story of aluminum framed systems designated by Owner shall be tested according to AAMA 501.2 and shall not evidence water penetration.
- C. Repair or remove work if test results and inspections indicate that it does not comply with specified requirements.
- D. Additional testing and inspecting, at Contractor's expense, will be performed to determine compliance of replaced or additional work with specified requirements.
- E. Aluminum framed assemblies will be considered defective if they do not pass tests and inspections.
- F. Prepare test and inspection reports.

3.5 ADJUSTING

- A. Adjust operating entrance door hardware to function smoothly as recommended by Manufacturer.
 - 1. For entrance doors accessible to people with disabilities, adjust closers to provide a 3-second closer sweep period for doors to move from a 70-degree open position to 3 inches from the latch, measured to the leading door edge.

** END OF SECTION **

**SECTION 100080
FIRE RATED ENTRANCES
AND STOREFRONTS**

PART 1 - GENERAL

1.1 Summary

A. Section Includes:

1. Fire rated curtain wall system, including perimeter trims, stools, accessories, shims and anchors, and perimeter sealing of curtain wall framing.

B. Related Sections include the following:

1. Section 10 "Aluminum Framed Entrances and Storefronts" for entrances installed in non-rated applications.
2. Section 10 "Door Hardware" for door hardware for all entrances.
3. Section 24 "Glazing" for glazing in fire rated applications.

1.2 REFERENCES

A. American Architectural Manufacturers Association (AAMA)

1. AAMA 501.1-2005: Standard Test Method for Water Penetration of Windows, Curtain Walls, and Doors Using Dynamic Pressure
2. AAMA 501.2-2003: Quality Assurance and Diagnostic Water Leakage Field Check of Installed Storefronts, Curtain Walls, and Sloped Glazing Systems
3. AAMA 501.4-2000 (Revised 2001): Recommended Static Test Method for Evaluating Curtain Wall and Storefront Systems Subjected to Seismic and Wind Induced Interstory Drifts
4. AAMA 501.5-2005: Test Method for Thermal Cycling of Exterior Walls
5. AAMA 506-2000 (Revised 2003): Voluntary Specifications for Hurricane Impact and Cycle Testing of Fenestration Products
6. AAMA 1503-1998: Voluntary Test Method for Thermal Transmittance and Condensation Resistance of Windows, Doors and Glazed Wall Sections
7. AAMA 2603-2002 - Voluntary Specification, Performance Requirements and Test Procedures for Pigmented Organic Coatings on Aluminum Extrusions and Panels.
8. AAMA 2604-2005 - Voluntary Specification, Performance Requirements and Test Procedures for High Performance Organic Coatings on Aluminum Extrusions and Panels.
9. AAMA 2605-2005 - Voluntary Specification, Performance Requirements and Test Procedures for Superior Performing Organic Coatings on Aluminum Extrusions and Panels.

B. American Society for Testing and Materials (ASTM):

1. Fire safety related:
 - a. ASTM E119: Methods for Fire Tests of Building Construction and Materials.

- b. ASTM E2074-00: Standard Test Method for Fire Tests of Door Assemblies, Including Positive Pressure Testing of Side-Hinged and Pivoted Swinging Door Assemblies.
 - c. ASTM E2010-01: Standard Test Method for Positive Pressure Fire Tests of Window Assemblies.
- 2. Material related
 - a. ASTM A 1008 - Standard Specification for Steel, Sheet, Cold-Rolled, Carbon, Structural, High-Strength, Low Alloy, and High-Strength Low-Alloy with Improved Formability, Solution Hardened, and Bake Hardenable; 2007.
 - b. ASTM A 1011 - Standard Specification for Steel, Sheet and Strip, Hot-Rolled, Carbon, Structural, High-Strength Low-Alloy and High-Strength Low-Alloy with Improved Formability, and Ultra-High Strength; 2006b.
- 3. Exterior related
 - a. ASTM E 283-04: Test Method for Determining the Rate of Air Leakage through Exterior Windows, Curtain Walls, and Doors under Specified Pressure Differences across the Specimen
 - b. ASTM E 330-02: Test Method for Structural Performance of Exterior Windows, Doors, Skylights and Curtain Walls by Uniform Static Air Pressure Difference Procedure A
 - c. ASTM E 331-04: Test Method for Water Penetration of Exterior Windows, Skylights, Doors, and Curtain Walls by Uniform Static Air Pressure Difference
 - d. ASTM E 783-02: Test Method for Field Measurement of Air Leakage through Installed Exterior Windows and Doors
 - e. ASTM E 1105-00: Test Method for Field Determination of Water Penetration of Installed Exterior Windows, Skylights, Doors, and Curtain Walls by Uniform or Cyclic Static Air Pressure Difference
- 4. Sound related:
 - a. ASTM E 90-04: Test Method for Laboratory Measurement of Airborne Sound Transmission Loss of Building Partitions and Elements
 - b. ASTM E 413-04: Standard Classification for Rating Sound Insulation
- C. American Welding Society (AWS)
 - 1. AWS D1.3 - Structural Welding Code - Sheet Steel; 2007
- D. Builders Hardware Manufacturers Association, Inc
 - 1. BHMA A156 - American National Standards for door hardware; 2006 (ANSI/BHMA A156).
- E. National Fire Protection Association (NFPA):
 - 1. NFPA 80: Fire Doors and Windows.
 - 2. NFPA 251: Fire Tests of Building Construction & Materials
 - 3. NFPA 252: Fire Tests of Door Assemblies
 - 4. NFPA 257: Fire Test of Window Assemblies

- F. Underwriters Laboratories, Inc. (UL):
 - 1. UL 9: Fire Tests of Door Assemblies
 - 2. UL 10 B: Fire Tests of Door Assemblies
 - 3. UL 10 C: Positive Pressure Fire Tests of Window & Door Assemblies
 - 4. UL 263: Fire tests of Building Construction and Materials
- G. Uniform Building Code
 - 1. UBC 7-2 (1997) - Fire Tests of Door Assemblies, Parts I and II
 - 2. UBC 7-4 (1997) - Fire Tests of Window Assemblies
- H. American National Standards Institute (ANSI):
 - 1. ANSI Z97.1: Standard for Safety Glazing Materials Used in Buildings
- I. Consumer Product Safety Commission (CPSC):
 - 1. CPSC 16 CFR 1201: Safety Standard for Architectural Glazing Materials
- J. American Society of Civil Engineers (ASCE)
 - 1. ASCE 7 - Minimum Design Loads for Buildings and Other Structures;; 2005

1.3 PERFORMANCE REQUIREMENTS

- A. System Description:
 - 1. Steel fire rated glazed curtain wall system, outside glazed pressure plate, cover cap format.
 - 2. Face Width: 2 3/8 inch.
 - 3. Water Drainage:
 - a. System is vertically weeped. No joint plugs or weep holes at horizontal mullions. Horizontal gaskets are notched and received by vertical gaskets.
- B. Structural Loads:
 - 1. Uniform Wind Load: ASTM E 330; Static air design load of 40 psf applied in positive and negative direction; no deflection in excess of L/175 of span of any framing member at design load.
 - 2. At structural test load equal to 1.5 times specified design load, no glass breakage or permanent set in the framing members in excess of 0.2% of their clear spans shall occur.
- C. Air Infiltration: ASTM E 283; Air infiltration rate shall not exceed 0.06 cfm/ft² at a static air pressure differential of 6.24 psf.
- D. Water Resistance, (static): ASTM E 331; No leakage at a static air pressure differential of 30 psf as defined in AAMA 501.

- E. Water Resistance, (dynamic): AAMA 501.1; No leakage at an air pressure differential of 30 psf as defined in AAMA 501.
- F. Thermal Movements: Provide steel fire rated glazed curtain-wall systems that allow for thermal movements resulting from the following maximum change (range) in ambient and surface temperatures. Base engineering calculation on surface temperatures of materials due to both solar heat gain and nighttime-sky heat loss.
 - 1. Temperature Change (Range): 120 deg F, ambient; 180 deg F, material surfaces.

1.4 SUBMITTALS

- A. Product Data: Include construction details, material descriptions, dimensions of individual components and profiles, and finishes for each type of product indicated.
- B. Shop Drawings: Prepared by or under the supervision of a qualified professional engineer detailing fabrication and assembly of steel fire rated glazed curtain-wall systems.
 - 1. Include structural analysis data signed and sealed by the qualified professional engineer responsible for their preparation.
- C. Samples for Initial Selection: For units with factory-applied color finishes.

1.5 QUALITY ASSURANCE

- A. Installer Qualifications: Installer experienced (as determined by contractor) to perform work of this section who has specialized in the installation of work similar to that required for this project and who is acceptable to product Manufacturer.
 - 1. Engineering Responsibility: Preparation of data for glazed curtainwall systems including the following:
 - a. Shop Drawings based on testing and engineering analysis of Manufacturer's standard units in assemblies similar to those indicated for this Project and submission of reports of tests performed on Manufacturer's standard assemblies.
 - b. Shop Drawings and comprehensive engineering analysis by a qualified professional engineer.
- B. Manufacturer Qualifications: Manufacturer capable of providing field service representation during construction, approving acceptable installer and approving application method.
- C. Pre-Installation Meetings: Conduct pre-installation meeting to verify project requirements, substrate conditions, Manufacturer's installation instructions, and Manufacturer's warranty requirements.

1.6 DELIVERY, STORAGE, AND HANDLING

- A. Ordering: Comply with Manufacturer's ordering instructions and lead-time requirements to avoid construction delays.

- B. Packing, Shipping, Handling, and Unloading: Deliver materials in Manufacturer's original, unopened, undamaged containers with identification labels intact.
- C. Storage and Protection: Store materials protected from exposure to harmful weather conditions. Handle material and components to avoid damage. Protect curtainwall material against damage from elements, construction activities, and other hazards before, during and after curtainwall installation.

1.7 PROJECT CONDITIONS

- A. Field Measurements: Verify actual locations of structural supports for steel fire rated glazed curtain-wall systems by field measurements before fabrication and indicate measurements on Shop Drawings.
 - 1. Established Dimensions: Where field measurements cannot be made without delaying the Work, establish dimensions and proceed with fabricating steel fire rated glazed curtain-wall systems without field measurements. Coordinate construction to ensure that actual dimensions correspond to established dimensions.

1.8 WARRANTY

- A. Assembly Warranty: Manufacturer's standard form in which Manufacturer agrees to repair or replace components of steel fire rated glazed curtain-wall systems that do not comply with requirements or that deteriorate as defined in this Section within specified warranty period.
 - 1. Failures include, but are not limited to, the following:
 - a. Structural failures including, but not limited to, excessive deflection.
 - b. Noise or vibration caused by thermal movements.
 - c. Deterioration of metals, metal finishes, and other materials beyond normal weathering.
 - d. Water leakage.
 - e. Failure of operating components to function normally.
 - 2. Provide **Firelite** glass supplier's limited five year warranty from the date of shipment from the factory.
- B. Finish Warranty: Manufacturer's standard form in which Manufacturer agrees to repair or replace components on which finishes fail within specified warranty period. Warranty does not include normal weathering.
 - 1. Warranty Period: **2 years** from date of substantial completion.

PART 2 - PRODUCTS

2.6 PRODUCTS GENERAL

- A. Frame System: **Fireframes® Curtainwall Series 120M** fire rated steel frame system as supplied by **Technical Glass Products** 8107 Bracken Place SE, Snoqualmie, WA 98065 (800-426-0279) fax (800-451-9857) e-mail sales@fireglass.com web site <http://www.fireglass.com>.
- B. Entrance System: **Fireframes® Designer Series 90M** fire rated steel frame system as supplied by **Technical Glass Products** 8107 Bracken Place SE, Snoqualmie, WA 98065 (800-426-0279) fax (800-451-9857) e-mail sales@fireglass.com web site <http://www.fireglass.com>.
- C. Refer to attached Manufacturer's catalog cut sheets of curtainwall and designer series products.
- D. Refer to Door Schedule for door and frame elevations.
- E. Substitutions: No substitutions allowed.

2.7 HARDWARE

- A. Provide complete hardware package included as part of the Fire Rated Entrance System from **TGP** except for Hardware listed in Section 087100 "Door Hardware". Hardware provided as part of the **TGP** package to be compatible with fail safe hardware specified in Section 087100 and to match finish specified for other hardware in Section 087100. Fire Rated Entrance door system to operate in a fail safe mode. GC to provide all hardware and power required for a fail safe operation.

2.8 MATERIALS - GLASS

- A. Fire Rated Glazing: ASTM C 1036 and ASTM C 1048.
- B. Thickness of Glazing Material: 1 inch insulated **Firelite Plus, 90M** at doors and **120M** at curtainwall framing.
- C. Logo: Each piece of fire rated glazing shall be labeled with a permanent logo including name of product, manufacture, testing laboratory (UL), fire rating period, safety glazing standards, and date of manufacture.

2.9 MATERIALS –STEEL FRAMING

- A. Steel Curtainwall Framing System **120 min.**
 - 1. Steel Frame: Profiled steel tubing permanently joined with steel bolts.
 - 2. Steel Pressure Plates: Formed stainless steel pressure plate with dimensions recommended by Manufacturer to securely hold glazing material in place.
- B. Aluminum: Alloy and temper recommended by Manufacturer for type of use and finish indicated.
 - 1. Extruded Bars, Rods, Shapes, and Tubes: ASTM B 221.
- C. Steel Reinforcement: With Manufacturer's standard corrosion resistant primer complying with SSPC-PS Guide No. 12.00 applied immediately after surface preparation and pretreatment.

Select surface preparation methods according to recommendations in SSPC-SP COM and prepare surfaces according to applicable SSPC standard.

1. Structural Shapes, Plates, and Bars: ASTM A 36.
2. Cold-Rolled Sheet and Strip: ASTM A 611.
3. Hot-Rolled Sheet and Strip: ASTM A 570.

- D. Brackets and Reinforcements: Manufacturer's standard high-strength materials with non-staining, non-ferrous shims for aligning system components.
- E. Fasteners and Accessories: Manufacturer's standard corrosion-resistant, non-staining, non-bleeding fasteners and accessories compatible with adjacent materials.
1. Where fasteners are subject to loosening or turn out from thermal and structural movements, wind loads, or vibration, use self-locking devices.
 2. Reinforce members as required to receive fastener threads.
- F. Anchors: Three-way adjustable anchors that accommodate fabrication and installation tolerances in material and finish compatible with adjoining materials and recommended by Manufacturer.
1. Concrete and Masonry Inserts: Hot-dip galvanized cast-iron, malleable-iron, or steel inserts complying with ASTM A 123 or ASTM A 153 requirements.
- G. Concealed Flashing: Manufacturer's standard corrosion-resistant, non-staining, non-bleeding flashing compatible with adjacent materials.

2.10 ACCESSORIES

- A. Exposed Fasteners: Use fasteners fabricated from Type 304 stainless steel.
- B. Glazing Gaskets:
1. Exterior Applications: ASTM C 864; extruded EPDM rubber that provides for silicone adhesion.
 2. Interior Applications: Glaze Firelite glass with approved pure silicone sealant.

- C. Intumescent Tape: As supplied by frame Manufacturer.
- D. Setting Blocks: Calcium silicate.
- E. Perimeter Anchors: Steel or 316 Stainless steel when exposed.
- F. Flashings: As recommended by Manufacturer; same material and finish as cover caps.
- G. Silicone Sealant: One-Part Low Modulus, High Movement-Capable Sealant: Type S; Grade NS; Class 25 with additional movement capability of 100 percent in extension and 50 percent in compression (total 150 percent); Use (Exposure) NT; Uses (Substrates) M, G, A, and O as applicable. (Use-O joint substrates include: Metal factory-coated with a high-performance coating; galvanized steel; ceramic tile.)
 - 1. Available Products:
 - a. Dow Corning **790** - Dow Corning Corp.
- H. Intumescent Caulk: Single component, latex-based, intumescent caulk designed to stop passage of fire, smoke, and fumes through fire rated separations; permanently flexible after cure; will not support mold growth; flame spread/smoke developed 10/10.
 - 1. Available Products:
 - a. Firetemp CI - John-Manville.

2.11 SLAG-WOOL-FIBER/ROCK-WOOL-FIBER INSULATION

- A. Available Manufacturers:
 - 1. Fibrex Insulations Inc.
 - 2. Owens Corning.
 - 3. Thermafiber.
- B. Unfaced, Slag-Wool-Fiber/Rock-Wool-Fiber Board Insulation: ASTM C 612, maximum flame-spread and smoke-developed indexes of 15 and 0, respectively; passing ASTM E 136 for combustion characteristics; and of the following nominal density and thermal resistivity:
 - 1. Nominal density of 4 lb/cu. ft., Types IA and IB, thermal resistivity of 4 deg F x h x sq. ft./Btu x in. at 75 deg F.
 - 2. Fiber Color: Regular color, unless otherwise indicated.

2.12 FABRICATION

- A. General:
 - 1. Fabricate components per Manufacturer's installation instructions and with minimum clearances and shim spacing around perimeter of assembly, yet enabling installation and dynamic movement of perimeter seal.

2. Accurately fit and secure joints and corners. Make joints flush and weatherproof.
3. Prepare components to receive anchor devices.
4. Fabricate anchors.
5. Arrange fasteners and attachments to be concealed from view.

2.13 FINISHES, GENERAL

- A. Comply with NAAMM's "Metal Finishes Manual for Architectural and Metal Products" for recommendations for applying and designating finishes.
- B. Appearance of Finished Work: Variations in appearance of abutting or adjacent pieces are acceptable. Noticeable variations in the same piece are not acceptable.

2.14 INTERIOR STEEL FINISHES

- A. Color Coated Finish: Apply Manufacturer's standard powder coating finish system applied to factory assembled frames before shipping, complying with Manufacturer's written instructions for surface preparation including pretreatment, application, and minimum dry film thickness.
 1. Color and Gloss: To be **selected by Owner** from Manufacturer's full range to match finish color selected for other aluminum window and door products specified elsewhere.

2.15 ALUMINUM FINISHES

- A. Finish designations prefixed by AA comply with the system established by the Aluminum Association for designating aluminum finishes.
- B. High-Performance Organic Finish (2-Coat Fluoropolymer): AA-C12C40R1x (Chemical Finish: cleaned with inhibited chemicals; Chemical Finish: conversion coating; Organic Coating: Manufacturer's standard 2-coat, thermocured system consisting of specially formulated inhibitive primer and fluoropolymer color topcoat containing not less than 70 percent polyvinylidene fluoride resin by weight). Prepare, pretreat, and apply coating to exposed metal surfaces to comply with AAMA 2604 and 2605 and with coating and resin Manufacturers' written instructions.
 1. Color and Gloss: To be **selected by Owner** from Manufacturer's full range to match finish color selected for other aluminum window and door products specified elsewhere.

PART 3 - EXECUTION

3.6 EXAMINATION

- A. Site Verification of Conditions: Verify substrate conditions (which have been previously installed under other sections) are acceptable for product installation in accordance with Manufacturer's instructions. Verify openings are sized to receive curtain wall system and sill plate is level in accordance with Manufacturer's acceptable tolerances.

1. Field Measurements: Verify actual measurements/openings by field measurements before fabrication; show recorded measurements on shop drawings. Coordinate field measurements, fabrication schedule with construction progress to avoid construction delays.

3.7 INSTALLATION

- A. General: Install curtain wall systems plumb, level, and true to line, without warp or rack of frames with Manufacturer's prescribed tolerances and installation instructions. Provide support and anchor in place.
- B. Install fireframe system by a specialty contractor with appropriate experience qualifications; and in strict accordance with the approved shop drawings. Employ experienced mechanics familiar with this type of specialized work.
- C. Glazing: Glass shall be outside glazed and held in place with stainless steel pressure plates anchored to the mullion using stainless steel fasteners spaced no greater than 12-inches on center.
- D. Install glazing in strict accordance with fire resistant glazing material Manufacturer's specifications. Field cutting or tampering is not permissible.
- E. Firmly pack perimeter of framing system to rough opening with mineral wool fire stop insulation or appropriately rated intumescent sealant.

3.8 FIELD QUALITY CONTROL

- A. Field Tests: Owner shall select curtain wall units to be tested as soon as a representative portion of the project has been installed, glazed, perimeter caulked and cured. Conduct tests for air infiltration and water penetration with Manufacturer's representative present. Tests not meeting specified performance requirements and units having deficiencies should be corrected as part of the contract amount.
 1. Testing: Testing shall be performed per AAMA 503 by a qualified independent testing agency. Refer to Division 1 Testing Section for payment of testing and testing requirements.
 2. Air Infiltration Tests: Conduct tests in accordance with ASTM E 783. Allowable air infiltration shall not exceed 1.5 times the amount indicated in the performance requirements or 0.09 cfm/ft², which ever is greater.
 3. Water Infiltration Tests: Conduct tests in accordance with ASTM E 1105. No uncontrolled water leakage is permitted when tested at a static test pressure of two-thirds the specified water penetration pressure but not less than 8 psf.
- B. Manufacturer's Field Services: Upon Owner's request, provide Manufacturer's field service consisting of product use recommendations and periodic site visit for inspection of product installation in accordance with Manufacturer's instructions.

3.9 PROTECTION AND CLEANING

- A. Protection: Protect installed product's finish surfaces from damage during construction. Protect steel fire rated glazed curtainwall system from damage from grinding and polishing compounds, plaster, lime, acid, cement, or other harmful contaminants.
 - 1. Cleaning: Repair or replace damaged installed products. Clean installed products in accordance with Manufacturer's instructions prior to owner's acceptance. Remove construction debris from project site and legally dispose of debris.

** END OF SECTION **

SECTION 101000 DOOR HARDWARE

PART 1 - GENERAL

1.1 SUMMARY

A. Section includes:

1. Mechanical door hardware for the following:
 - a. Swinging doors.
 - b. Sliding doors.
 - c. Folding doors.
2. Cylinders for door hardware specified in other Sections.
3. Electrified door hardware.

B. Related Sections:

1. Section 10 "Hollow Metal Doors and Frames" for astragals provided as part of labeled fire-rated assemblies and for door silencers provided as part of hollow-metal frames.
2. Section 10 "Access Doors and Frames" for access door hardware, including cylinders.
3. Section 10 "Sectional Doors" for door hardware provided as part of overhead door assemblies.
4. Section 10 "Fire Rated Entrances and Storefronts" for door hardware provided as part of fire-rated door assemblies.
5. Section 10 "Aluminum-Framed Entrances and Storefronts" for installation of entrance door hardware, including cylinders.

1.2 ACTION SUBMITTALS

A. Product Data: For each type of product indicated. Include construction and installation details, material descriptions, dimensions of individual components and profiles, and finishes.

B. Shop Drawings: Details of electrified door hardware, indicating the following:

1. Wiring Diagrams: For power, signal, and control wiring and including the following:
 - a. Details of interface of electrified door hardware and building safety and security systems.
 - b. Schematic diagram of systems that interface with electrified door hardware.
 - c. Point-to-point wiring.
 - d. Risers.
 - e. Elevations doors controlled by electrified door hardware.
2. Operation Narrative: Describe the operation of doors controlled by electrified door hardware.

- C. Samples for Initial Selection: For plastic protective trim units in each finish, color, and texture required for each type of trim unit indicated.
- D. Samples for Verification: For exposed door hardware of each type required, in each finish specified, prepared on Samples of size indicated below. Tag Samples with full description for coordination with the door hardware schedule. Submit Samples before, or concurrent with, submission of door hardware schedule.
 - 1. Sample Size: Full-size units or minimum 2-by-4-inch Samples for sheet and 4-inch long Samples for other products.
 - a. Full-size Samples will be returned to Contractor. Units that are acceptable and remain undamaged through submittal, review, and field comparison process may, after final check of operation, be incorporated into the Work, within limitations of keying requirements.
- E. Other Action Submittals:
 - 1. Door Hardware Schedule: Prepared by or under the supervision of Installer, detailing fabrication and assembly of door hardware, as well as installation procedures and diagrams. Coordinate final door hardware schedule with doors, frames, and related work to ensure proper size, thickness, hand, function, and finish of door hardware.
 - a. Submittal Sequence: Submit door hardware schedule concurrent with submissions of Product Data, Samples, and Shop Drawings. Coordinate submission of door hardware schedule with scheduling requirements of other work to facilitate the fabrication of other work that is critical in Project construction schedule.
 - b. Format: Comply with scheduling sequence and vertical format in DHI's "Sequence and Format for the Hardware Schedule." Double space entries, and number and date each page.
 - c. Format: Use same scheduling sequence and format and use same door numbers as in the Contract Documents.
 - d. Content: Include the following information:
 - 1) Identification number, location, hand, fire rating, size, and material of each door and frame.
 - 2) Locations of each door hardware set, cross-referenced to Drawings on floor plans and to door and frame schedule.
 - 3) Complete designations, including name and manufacturer, type, style, function, size, quantity, function, and finish of each door hardware product.
 - 4) Description of electrified door hardware sequences of operation and interfaces with other building control systems.
 - 5) Fastenings and other pertinent information.
 - 6) Explanation of abbreviations, symbols, and codes contained in schedule.
 - 7) Mounting locations for door hardware.
 - 8) List of related door devices specified in other Sections for each door and frame.
 - 2. Keying Schedule: Prepared by or under the supervision of Installer, detailing Owner's final keying instructions for locks. Include schematic keying diagram and index each key set to unique door designations that are coordinated with the Contract Documents.

1.3 INFORMATIONAL SUBMITTALS

- A. Qualification Data: For Architectural Hardware Consultant.
- B. Product Certificates: For electrified door hardware, from the manufacturer.
 - 1. Certify that door hardware approved for use on types and sizes of labeled fire-rated doors complies with listed fire-rated door assemblies.
- C. Product Test Reports: For compliance with accessibility requirements, based on evaluation of comprehensive tests performed by manufacturer and witnessed by a qualified testing agency, for door hardware on doors located in accessible routes.
- D. Warranty: Special warranty specified in this Section.

1.4 CLOSEOUT SUBMITTALS

- A. Maintenance Data: For each type of door hardware to include in maintenance manuals. Include final hardware schedule.

1.5 QUALITY ASSURANCE

- A. Installer Qualifications: Supplier of products and an employer of workers trained and approved by product manufacturers and an Architectural Hardware Consultant who is available during the course of the Work to consult with Contractor, Architect, and Owner about door hardware and keying.
 - 1. Warehousing Facilities: In Project's vicinity.
 - 2. Scheduling Responsibility: Preparation of door hardware and keying schedules.
 - 3. Engineering Responsibility: Preparation of data for electrified door hardware, including Shop Drawings, based on testing and engineering analysis of manufacturer's standard units in assemblies similar to those indicated for this Project.
- B. Architectural Hardware Consultant Qualifications: A person who is experienced in providing consulting services for door hardware installations that are comparable in material, design, and extent to that indicated for this Project and who is currently certified by DHI as follows:
 - 1. For door hardware, an Architectural Hardware Consultant (AHC).
- C. Source Limitations: Obtain each type of door hardware from a single manufacturer.
 - 1. Provide electrified door hardware from same manufacturer as mechanical door hardware, unless otherwise indicated. Manufacturers that perform electrical modifications and that are listed by a testing and inspecting agency acceptable to authorities having jurisdiction are acceptable.
- D. Fire-Rated Door Assemblies: Where fire-rated door assemblies are indicated, provide door hardware rated for use in assemblies complying with NFPA 80 that are listed and labeled by a qualified testing agency, for fire-protection ratings indicated, based on testing at positive pressure according to NFPA 252 or UL 10C, unless otherwise indicated.

- E. Smoke- and Draft-Control Door Assemblies: Where smoke- and draft-control door assemblies are required, provide door hardware that meet requirements of assemblies tested according to UL 1784 and installed in compliance with NFPA 105.
 - 1. Air Leakage Rate: Maximum air leakage of **0.3 cfm/sq. ft.** at the tested pressure differential of **0.3-inch wg** of water.
- F. Electrified Door Hardware: Listed and labeled as defined in NFPA 70, Article 100, by a testing agency acceptable to authorities having jurisdiction.
- G. Means of Egress Doors: Latches do not require more than **15 lbf** to release the latch. Locks do not require use of a key, tool, or special knowledge for operation.
- H. Accessibility Requirements: For door hardware on doors in an accessible route, comply with the U.S. Architectural & Transportation Barriers Compliance Board's ADA-ABA Accessibility Guidelines and ICC/ANSI A117.1.
 - 1. Provide operating devices that do not require tight grasping, pinching, or twisting of the wrist and that operate with a force of not more than **5 lbf**.
 - 2. Comply with the following maximum opening-force requirements:
 - a. Interior, Non-Fire-Rated Hinged Doors: **5 lbf** applied perpendicular to door.
 - b. Sliding or Folding Doors: **5 lbf** applied parallel to door at latch.
 - c. Fire Doors: Minimum opening force allowable by authorities having jurisdiction.
 - 3. Bevel raised thresholds with a slope of not more than 1:2. Provide thresholds not more than **1/2 inch** high.
 - 4. Adjust door closer sweep periods so that, from an open position of 70 degrees, the door will take at least 3 seconds to move to a point **3 inches** from the latch, measured to the leading edge of the door.
- I. Keying Conference: Cylinder cores by Owner.
- J. Preinstallation Conference: Conduct conference at Project site.
 - 1. Review and finalize construction schedule and verify availability of materials, Installer's personnel, equipment, and facilities needed to make progress and avoid delays.
 - 2. Inspect and discuss preparatory work performed by other trades.
 - 3. Inspect and discuss electrical roughing-in for electrified door hardware.
 - 4. Review sequence of operation for each type of electrified door hardware.
 - 5. Review required testing, inspecting, and certifying procedures.

1.6 DELIVERY, STORAGE, AND HANDLING

- A. Inventory door hardware on receipt and provide secure lock-up for door hardware delivered to Project site.
- B. Tag each item or package separately with identification coordinated with the final door hardware schedule, and include installation instructions, templates, and necessary fasteners with each item or package.

1.7 COORDINATION

- A. Coordinate layout and installation of floor-recessed door hardware with floor construction. Cast anchoring inserts into concrete.
- B. Installation Templates: Distribute for doors, frames, and other work specified to be factory prepared. Check Shop Drawings of other work to confirm that adequate provisions are made for locating and installing door hardware to comply with indicated requirements.
- C. Security: Coordinate installation of door hardware, keying, and access control with Owner's security consultant.
- D. Electrical System Roughing-In: Coordinate layout and installation of electrified door hardware with connections to power supplies and building safety and security systems.
- E. Existing Openings: Where hardware components are scheduled for application to existing construction or where modifications to existing door hardware are required, field verify existing conditions and coordinate installation of door hardware to suit opening conditions and to provide proper door operation.

1.8 WARRANTY

- A. Special Warranty: Manufacturer's standard form in which manufacturer agrees to repair or replace components of door hardware that fail in materials or workmanship within specified warranty period.
 - 1. Failures include, but are not limited to, the following:
 - a. Structural failures including excessive deflection, cracking, or breakage.
 - b. Faulty operation of doors and door hardware.
 - c. Deterioration of metals, metal finishes, and other materials beyond normal weathering and use.
 - 2. Warranty Period: Manufacturer standard warranty, unless otherwise indicated.
 - a. Exit Devices: Two years from date of Substantial Completion.
 - b. Manual Closers: 10 years from date of Substantial Completion.

1.9 MAINTENANCE SERVICE

- A. Maintenance Tools and Instructions: Furnish a complete set of specialized tools and maintenance instructions for Owner's continued adjustment, maintenance, and removal and replacement of door hardware.
- B. Maintenance Service: Beginning at Substantial Completion, provide six months' full maintenance by skilled employees of door hardware Installer. Include quarterly preventive maintenance, repair or replacement of worn or defective components, lubrication, cleaning, and adjusting as required for proper door and door hardware operation. Provide parts and supplies that are the same as those used in the manufacture and installation of original products.

PART 2 - PRODUCTS

2.1 SCHEDULED DOOR HARDWARE

- A. Provide door hardware for each door as scheduled in Part 3 "Door Hardware Schedule" Article / on Drawings to comply with requirements in this Section.
 - 1. Door Hardware Sets: Provide quantity, item, size, finish or color indicated, and named manufacturers' products or approved products equivalent in function and comparable in quality to named products.
 - 2. Sequence of Operation: Provide electrified door hardware function, sequence of operation, and interface with other building control systems indicated.
- B. Designations: Requirements for design, grade, function, finish, size, and other distinctive qualities of each type of door hardware are indicated in Part 3 "Door Hardware Schedule" Article. Products are identified by using door hardware designations, as follows:
 - 1. Named Manufacturers' Products: Manufacturer and product designation are listed for each door hardware type required for the purpose of establishing minimum requirements. Manufacturers' names are abbreviated in Part 3 "Door Hardware Schedule" Article.
 - 2. References to BHMA Designations: Provide products complying with these designations and requirements for description, quality, and function.

2.2 HINGES

- A. Hinges: BHMA A156.1. Provide template-produced hinges for hinges installed on hollow-metal doors and hollow-metal frames.
 - 1. Manufacturers: Subject to compliance with requirements, provide products by one of the following:
 - a. Hager Companies.
 - b. IVES Hardware; an Ingersoll-Rand company.
 - c. McKinney Products Company; an ASSA ABLOY Group company.
 - d. Stanley Commercial Hardware; Div. of The Stanley Works.

2.3 CONTINUOUS HINGES

- A. Continuous, Gear-Type Hinges: Extruded-aluminum, pinless, geared hinge leaves joined by a continuous extruded-aluminum channel cap; with concealed, self-lubricating thrust bearings.
 - 1. Manufacturers: Subject to compliance with requirements, provide products by one of the following:
 - a. Roton.
 - b. Pemko.

2.4 MECHANICAL LOCKS AND LATCHES

- A. Lock Functions: As indicated in door hardware schedule.
- B. Lock Throw: Comply with testing requirements for length of bolts required for labeled fire doors, and as follows:
 - 1. Bored Locks: Minimum **1/2-inch** latchbolt throw.
- C. Lock Backset: **2-3/4 inches**, unless otherwise indicated.
- D. Lock Trim:
 - 1. Description: As indicated on Hardware Sets.
 - 2. Levers: Wrought.
 - a. Best 9K-3.
 - 3. Operating Device: Lever 15D.
- E. Strikes: Provide manufacturer's standard strike for each lock bolt or latchbolt complying with requirements indicated for applicable lock or latch and with strike box and curved lip extended to protect frame; finished to match lock or latch.
 - 1. Flat-Lip Strikes: For locks with three-piece antifriction latchbolts, as recommended by manufacturer.
- F. Bored Locks: BHMA A156.2; Grade 1; Series 4000.
 - 1. Manufacturers: Subject to compliance with requirements, provide products by the following:
 - a. Best Access Systems; Div. of Stanley Security Solutions, Inc.; **No substitution, Owner Standard**

2.5 MANUAL FLUSH BOLTS

- A. Manual Flush Bolts: BHMA A156.16; minimum **3/4-inch** throw; designed for mortising into door edge.
 - 1. Manufacturers: Subject to compliance with requirements, provide products by one of the following:
 - a. Burns Manufacturing Incorporated.
 - b. IVES Hardware; an Ingersoll-Rand company.
 - c. Rockwood.

2.6 AUTOMATIC AND SELF-LATCHING FLUSH BOLTS

- A. Automatic and Self-Latching Flush Bolts: BHMA A156.16; minimum **3/4-inch** throw; designed for mortising into door edge.
 - 1. Basis-of-Design Product: Subject to compliance with requirements, provide product indicated on schedule or comparable product by one of the following:
 - a. IVES Hardware; an Ingersoll-Rand company.
 - b. Door Control Rockwood.

2.7 EXIT DEVICES AND AUXILIARY ITEMS

- A. Exit Devices and Auxiliary Items: BHMA A156.3.
 - 1. Basis-of-Design Product: Subject to compliance with requirements, provide product indicated on schedule:
 - a. Von Duprin; an Ingersoll-Rand company; **No substitution, Owner Standard**

2.8 LOCK CYLINDERS

- A. Lock Cylinders: Tumbler type, constructed from brass or bronze, stainless steel, or nickel silver.
 - 1. Basis-of-Design Product: Subject to compliance with requirements, provide product indicated on schedule.
 - a. Best Access Systems; Div. of Stanley Security Solutions, Inc.; **No substitution, Owner Standard**
 - b. Cores by Owner.
- B. Standard Lock Cylinders: Best, no Sub, cores by Owner.

2.9 KEYING

- A. By Owner.

2.10 OPERATING TRIM

- A. Operating Trim: BHMA A156.6; stainless steel, unless otherwise indicated.
 - 1. Basis-of-Design Product: Subject to compliance with requirements, provide product indicated on schedule or comparable product by one of the following:
 - a. Burns Manufacturing Incorporated.
 - b. IVES Hardware; an Ingersoll-Rand company.
 - c. Rockwood Manufacturing Company.

2.11 ACCESSORIES FOR PAIRS OF DOORS

- A. Coordinators: BHMA A156.3; consisting of active-leaf, hold-open lever and inactive-leaf release trigger; fabricated from steel with nylon-coated strike plates; with built-in, adjustable safety release; and with internal override.
- B. Astragals: BHMA A156.22.

2.12 SURFACE CLOSERS

- A. Surface Closers: BHMA A156.4; rack-and-pinion hydraulic type with adjustable sweep and latch speeds controlled by key-operated valves and forged-steel main arm. Comply with manufacturer's written recommendations for size of door closers depending on size of door, exposure to weather, and anticipated frequency of use. Provide factory-sized closers, adjustable to meet field conditions and requirements for opening force.
 - 1. Basis-of-Design Product: Subject to compliance with requirements, provide product indicated on schedule:
 - a. LCN Closers; an Ingersoll-Rand company; **No substitution, Owner Standard.**

2.13 MECHANICAL STOPS AND HOLDERS

- A. Wall- and Floor-Mounted Stops: BHMA A156.16; polished cast brass base metal.
 - 1. Basis-of-Design Product: Subject to compliance with requirements, provide product indicated on schedule or comparable product by one of the following:
 - a. Burns Manufacturing Incorporated.
 - b. IVES Hardware; an Ingersoll-Rand company.
 - c. Rockwood Manufacturing Company.

2.14 OVERHEAD STOPS AND HOLDERS

- A. Overhead Stops and Holders: BHMA A156.8.
 - 1. Basis-of-Design Product: Subject to compliance with requirements, provide product indicated on schedule or comparable product by one of the following:
 - a. Architectural Builders Hardware Mfg., Inc.
 - b. Glynn-Johnson; an Ingersoll-Rand company.
 - c. Rockwood Manufacturing Company.

2.15 DOOR GASKETING

- A. Door Gasketing: BHMA A156.22; air leakage not to exceed **0.50 cfm per foot** of crack length for gasketing other than for smoke control, as tested according to ASTM E 283; with resilient or

flexible seal strips that are easily replaceable and readily available from stocks maintained by manufacturer.

1. Basis-of-Design Product: Subject to compliance with requirements, provide product indicated on schedule:
 - a. National Guard Products.
 - b. Pemko Manufacturing Co.; an ASSA ABLOY Group company.
 - c. Reese Enterprises, Inc.

2.16 THRESHOLDS

- A. Thresholds: BHMA A156.21; fabricated to full width of opening indicated.

1. Basis-of-Design Product: Subject to compliance with requirements, provide product indicated on schedule:
 - a. National Guard Products.
 - b. Pemko Manufacturing Co.; an ASSA ABLOY Group company.
 - c. Reese Enterprises, Inc.

2.17 FABRICATION

- A. Manufacturer's Nameplate: Do not provide products that have manufacturer's name or trade name displayed in a visible location except in conjunction with required fire-rated labels and as otherwise approved by Owner.

1. Manufacturer's identification is permitted on rim of lock cylinders only.

- B. Base Metals: Produce door hardware units of base metal indicated, fabricated by forming method indicated, using manufacturer's standard metal alloy, composition, temper, and hardness. Furnish metals of a quality equal to or greater than that of specified door hardware units and BHMA A156.18.

- C. Fasteners: Provide door hardware manufactured to comply with published templates prepared for machine, wood, and sheet metal screws. Provide screws that comply with commercially recognized industry standards for application intended, except aluminum fasteners are not permitted. Provide Phillips flat-head screws with finished heads to match surface of door hardware, unless otherwise indicated.

1. Concealed Fasteners: For door hardware units that are exposed when door is closed, except for units already specified with concealed fasteners. Do not use through bolts for installation where bolt head or nut on opposite face is exposed unless it is the only means of securely attaching the door hardware. Where through bolts are used on hollow door and frame construction, provide sleeves for each through bolt.
2. Fire-Rated Applications:
 - a. Wood or Machine Screws: For the following:

- 1) Hinges mortised to doors or frames; use threaded-to-the-head wood screws for wood doors and frames.
 - 2) Strike plates to frames.
 - 3) Closers to doors and frames.
- b. Steel Through Bolts: For the following unless door blocking is provided:
- 1) Surface hinges to doors.
 - 2) Closers to doors and frames.
 - 3) Surface-mounted exit devices.
3. Spacers or Sex Bolts: For through bolting of hollow-metal doors.
 4. Fasteners for Wood Doors: Comply with requirements in DHI WDHS.2, "Recommended Fasteners for Wood Doors."
 5. Gasketing Fasteners: Provide noncorrosive fasteners for exterior applications and elsewhere as indicated.

2.18 FINISHES

- A. Provide finishes complying with BHMA A156.18 as indicated in door hardware schedule.
- B. Protect mechanical finishes on exposed surfaces from damage by applying a strippable, temporary protective covering before shipping.
- C. Appearance of Finished Work: Variations in appearance of abutting or adjacent pieces are acceptable if they are within one-half of the range of approved Samples. Noticeable variations in the same piece are not acceptable. Variations in appearance of other components are acceptable if they are within the range of approved Samples and are assembled or installed to minimize contrast.

PART 3 - EXECUTION

3.1 EXAMINATION

- A. Examine doors and frames, with Installer present, for compliance with requirements for installation tolerances, labeled fire-rated door assembly construction, wall and floor construction, and other conditions affecting performance.
- B. Examine roughing-in for electrical power systems to verify actual locations of wiring connections before electrified door hardware installation.
- C. Proceed with installation only after unsatisfactory conditions have been corrected.

3.2 PREPARATION

- A. Steel Doors and Frames: For surface applied door hardware, drill and tap doors and frames according to ANSI/SDI A250.6.

- B. Wood Doors: Comply with DHI WDHS.5 "Recommended Hardware Reinforcement Locations for Mineral Core Wood Flush Doors."

3.3 INSTALLATION

- A. Mounting Heights: Mount door hardware units at heights to comply with the following unless otherwise indicated or required to comply with governing regulations.
 - 1. Standard Steel Doors and Frames: ANSI/SDI A250.8.
- B. Install each door hardware item to comply with manufacturer's written instructions. Where cutting and fitting are required to install door hardware onto or into surfaces that are later to be painted or finished in another way, coordinate removal, storage, and reinstallation of surface protective trim units with finishing. Do not install surface-mounted items until finishes have been completed on substrates involved.
 - 1. Set units level, plumb, and true to line and location. Adjust and reinforce attachment substrates as necessary for proper installation and operation.
 - 2. Drill and countersink units that are not factory prepared for anchorage fasteners. Space fasteners and anchors according to industry standards.
- C. Hinges: Install types and in quantities indicated in door hardware schedule but not fewer than the number recommended by manufacturer for application indicated or one hinge for every **30 inches** of door height, whichever is more stringent, unless other equivalent means of support for door, such as spring hinges or pivots, are provided.
- D. Intermediate Offset Pivots: Where offset pivots are indicated, provide intermediate offset pivots in quantities indicated in door hardware schedule but not fewer than one intermediate offset pivot per door and one additional intermediate offset pivot for every **30 inches** of door height greater than **90 inches**.
- E. Lock Cylinders: Install construction cores to secure building and areas during construction period.
 - 1. Owner to replace construction cores with permanent cores.
- F. Boxed Power Supplies: Locate power supplies as indicated or, if not indicated, above accessible ceilings. Verify location with Owner.
 - 1. Configuration: Provide one power supply for each door opening with electrified door hardware.
- G. Thresholds: Set thresholds for exterior doors and other doors indicated in full bed of sealant complying with requirements specified in Section 24 "Joint Sealants."
- H. Stops: Provide floor stops for doors unless wall or other type stops are indicated in door hardware schedule. Do not mount floor stops where they will impede traffic.
- I. Perimeter Gasketing: Apply to head and jamb, forming seal between door and frame.
- J. Meeting Stile Gasketing: Fasten to meeting stiles, forming seal when doors are closed.

- K. Door Bottoms: Apply to bottom of door, forming seal with threshold when door is closed.

3.4 FIELD QUALITY CONTROL

- A. Independent Architectural Hardware Consultant: Owner will engage a qualified independent Architectural Hardware Consultant to perform inspections and to prepare inspection reports.
 - 1. Independent Architectural Hardware Consultant will inspect door hardware and state in each report whether installed work complies with or deviates from requirements, including whether door hardware is properly installed and adjusted.

3.5 ADJUSTING

- A. Initial Adjustment: Adjust and check each operating item of door hardware and each door to ensure proper operation or function of every unit. Replace units that cannot be adjusted to operate as intended. Adjust door control devices to compensate for final operation of heating and ventilating equipment and to comply with referenced accessibility requirements.
 - 1. Spring Hinges: Adjust to achieve positive latching when door is allowed to close freely from an open position of 30 degrees.
 - 2. Electric Strikes: Adjust horizontal and vertical alignment of keeper to properly engage lock bolt.
 - 3. Door Closers: Adjust sweep period to comply with accessibility requirements and requirements of authorities having jurisdiction.
- B. Occupancy Adjustment: Approximately six months after date of Substantial Completion, Installer's Architectural Hardware Consultant shall examine and readjust each item of door hardware, including adjusting operating forces, as necessary to ensure function of doors, door hardware, and electrified door hardware.

3.6 CLEANING AND PROTECTION

- A. Clean adjacent surfaces soiled by door hardware installation.
- B. Clean operating items as necessary to restore proper function and finish.
- C. Provide final protection and maintain conditions that ensure that door hardware is without damage or deterioration at time of Substantial Completion.

3.7 DEMONSTRATION

- A. Engage a factory-authorized service representative to train Owner's maintenance personnel to adjust, operate, and maintain door hardware and door hardware finishes. Refer to Section 30 "Demonstration and Training."

3.8 DOOR HARDWARE SCHEDULE

A. Hardware Sets: List of manufacturers represented in the hardware sets:

1. Best Lock Corp. (BES)
2. Glynn-Johnson; an Ingersoll-Rand company (GLY)
3. Hager Companies (HAG)
4. LCN Closers; an Ingersoll-Rand company (LCN)
5. Pemko Manufacturing Co.; an ASSA ABLOY Group company (PEM)
6. Rockwood Manufacturing Company (ROC)
7. Roton (ROT)
8. Securitron Magnalock Corporation; an ASSA ABLOY Group company (SEC)
9. Steelcraft Mfg. (STE)
10. Von Duprin; an Ingersoll-Rand company (VON)

** END OF SECTION **

**SECTION 120010
GENERAL PROVISIONS – MECHANICAL**

PART 1 - GENERAL

1.1 WORK INCLUDED

- A. Plumbing Work shall consist of the labor, materials and equipment required for installing the plumbing systems.
- B. Mechanical Work shall include the following Specification Sections and Drawings as outlined:

1. Specifications:

Section 200010	General Provisions – Mechanical
Section 120020	Plumbing Basic Materials
Section 120030	Plumbing Pipe and Pipe Fittings
Section 120040	Plumbing Piping Specialties
Section 120050	Plumbing Specialties
Section 120060	Plumbing Valves
Section 120070	Plumbing Supports and Anchors
Section 120080	Plumbing Insulation
Section 120110	Plumbing Pumps
Section 120120	Sanitary Drainage
Section 120130	Interceptors
Section 120140	Storm Drainage
Section 120150	Water Conditioning System
Section 120160	Water Heaters
Section 120170	Plumbing Fixtures
Section 120180	Special Piping Systems
Section 120190	Fuel Gas Piping and Specialties
Section 120200	Wiring of Plumbing Equipment

- C. Plumbing Work shall be bid as subcontracts in accordance with the bidding requirements.

1.2 TERMINOLOGY

- A. Wherever the term, “Contractor” is used in of the Specifications, it shall be interpreted to refer to the Contractor responsible for Work of these Divisions.
- B. Those responsible for Work covered by other portions of the Specification will be indicated by trade, such as Electrical Contractor, General Contractor, etc.

1.3 REFERENCE STANDARDS

- A. Portions or all of certain recognized industry or association standards referred to herein as being a requirement of these Specifications shall be considered as binding as though reproduced in full herein. Unless otherwise stated the referenced standard shall be the standard which is current as of the date of issuance of these Specifications. Reference may be made to standards either by full name or for the sake of brevity by letter designation only. The following is a list of the most commonly used standards, but is not all inclusive for these Specifications:

ABMA	American Bearing Manufacturers Association
ADA	Americans with Disabilities Act
AGA	American Gas Association
AMCA	Air Moving and Conditioning Association
ANSI	American National Standards Institute
API	American Petroleum Institute
ARI	American Refrigeration Institute
ASHRAE	American Society of Heating, Refrigerating and Air- Conditioning Engineers
ASME	American Society of Mechanical Engineers
ASSE	American Society of Sanitary Engineers
ASTM	American Society for Testing and Materials
AWS	American Welding Society
AWWA	American Water Works Association
CISPI	Cast Iron Soil Pipe Institute
FM	Factory Mutual Engineering Corporation
I-B-R	Institute of Boiler & Radiator Manufacturers
NEC	National Electrical Code
NEMA	National Electrical Manufacturers Association
NFPA	National Fire Protection Association
OSHA	Occupational Safety and Health Administration

PDI	Plumbing Drainage Institute
SMACNA	Sheet Metal and Air Conditioning Contractors National Association, Inc.
UL	Underwriters Laboratories, Inc.

1.4 PERMITS AND INSPECTIONS

- A. Secure all permits and inspections required by applicable authorities and pay all costs in connection with the Work.
- B. Schedule all inspections required by applicable authorities. Certificates shall be in triplicate and shall be delivered to Owner.
- C. Piping work, specialties, or equipment shall not be concealed or covered until same have been tested and inspected by municipal inspector(s) and observed by Owner. Municipal inspector(s) record of inspections shall be delivered to Owner. Owner and municipal inspector's witnessing of tests shall not relieve Contractor of his responsibility for concealed piping work and specialties, nor for equipment to perform in accordance with Contract Documents.

1.5 CODES AND STANDARDS

- A. Mechanical Work is subject to provisions of the Pennsylvania Uniform Construction Code and has been designed to be in compliance with the Code. Design aspect of the Project shall not be altered regarding building envelope or selection of HVAC, service water heating systems and equipment. Supplemental data published by equipment and system manufacturers to substantiate energy conservation efficiencies throughout the Project shall be furnished at request of Owner.
- B. Mechanical Work shall meet requirements of the National Fire Protection Association, all federal, state, and municipal authority's laws, rules and regulations applicable to the Work and public utilities having jurisdiction over systems specified herein.
- C. Domestic water heater(s) shall be constructed and tested in accordance with recommendations of the National Fire Protection Association, and ASME Code. Equipment shall be stamped with the ASME symbol and National Board number and shall be inspected during construction by an inspector who has been commissioned by the Pennsylvania Department of Labor and Industry to perform such service. Equipment shall be prepared for initial inspection in accordance with Pennsylvania Department of Labor and Industry regulations.
- D. Plumbing Work shall be installed in conformity with applicable portions of the International Plumbing Code, state plumbing codes, local ordinances, and shall be approved as Project progresses by Owner, and local plumbing inspector. Contractor shall certify domestic water systems for compliance with Pennsylvania Plumbing System Lead Ban & Notification Act (No. 33-1989). Nothing in the Specifications shall be construed to permit deviation from requirements of governing code(s).
- E. Installation of all gas piping and gas burning equipment shall conform to recommendations of the American Gas Association, Owner's insurance carrier, and the local utility.

- F. The handling and use of CFC and HCFC refrigerants, whether leaking, venting, recovering, etc., shall be in accordance with US Environmental Protection Agency regulations CFR 58 FR 28660, ASHRAE 15- Safety Code for Mechanical Refrigeration, and ANSI/ASHRAE 34 - Number Designation and Safety Classification of Refrigerants.
- G. Electrical Work shall meet requirements of the National Electrical Code and all federal, state, and municipal authority's laws, rules and regulations applicable to the Work.
- H. Where applicable, materials and equipment shall bear the label of approval of Underwriters Laboratories, Inc.
- I. Reference to codes and standards listed herein shall constitute minimum acceptable requirements. Where Drawings and Specification requirements exceed those of codes listed, Drawings and Specifications shall take precedence for Work of this Project.
- J. If Contractor, during the course of work, observes the existence of hazardous materials in the structure or on the project site, Contractor shall promptly notify Owner. Contractor shall not perform any work pertinent to the hazardous material prior to receipt of special instructions from Owner. "Hazardous materials", for the purpose of this Specification, are defined as asbestos, PCB's, petroleum, radioactive material, or hazardous waste substances.

1.6 SUBSTITUTIONS

- A. Specifications for each piece of equipment and each item of material are written around a product of a specific base manufacturer. This base manufacturer is the basis of design, dimensions and details. The base manufacturer's name and model information are included with the product description as the first named manufacturer under the heading "Acceptable Manufacturer".
- B. "Substitution" manufacturers are defined as any manufacturer other than the one used as the basis of design. "Substitution" manufacturers will be permitted, in accordance with the bidding requirements and where indicated herein.
- C. Manufacturers named in the product description, in addition to the base manufacturer, are "substitution" manufacturers, have been determined to be manufacturers capable of manufacturing products similar to the base manufacturer and these manufacturers are acceptable "substitution" manufacturers to the base manufacturer. Where additional manufacturer's names do not appear with the base manufacturer, the Owner reserves the right to disallow any "substitution" manufacturers. Where the base manufacturer's name is followed by the term "no substitution", no "substitution" manufacturers will be considered.
- D. Naming of specific manufacturers shall not be construed as eliminating products or services of other "substitution" manufacturers having comparable items. Where permitted by these Specifications, and where Bidder desires to use other "substitution" manufacturers, he may submit a request for approval to use the "substitution" manufacturer in accordance with bidding requirements.
- E. Products described in Specifications are intended to set a quality level and ensure a workable system. "Substitution" of manufacturers, including those herein named, may be made only after approval of Owner. Bidder shall assume full responsibility for installation and dimensional

changes required by the use of all “substitution” manufacturer’s products, including revisions to wiring, controls, piping, structural revisions, etc., and all room or space changes as required due to dimension differences of the “substitution” manufacturer product.

- F. Where the Bidding requirements call for submittal for approval of substitutions prior to bids due, all approvals given are for “substitution” manufacturers only, not approval of any particular product. An approved “substitution” manufacturer’s product must comply with all requirements of the specifications for the base manufacturer’s product.

1.7 SHOP DRAWINGS AND PRODUCT DATA

- A. Submit shop drawings and product data for approval to Owner. Shop drawings and product data shall have been reviewed and approved (stamped) by Contractor furnishing the equipment. If evidence of this Contractor’s approval does not appear on submittal data, submittals will be returned without review. Following Owner review, submittals not approved or requiring resubmission shall be corrected and resubmitted until satisfactory. Work indicated on shop drawings and product data shall not be executed until submittals have been approved.
- B. Submittals for equipment and material shall indicate room numbers, drawing identification symbols, product type, capacities, accessories, connection sizes, electrical characteristics, wiring diagrams, and installation instructions. Each shop drawing shall have specified items, accessories and options, as applicable to this Project, clearly marked. Catalog numbers, part numbers, etc. on shop drawings will not be reviewed for correctness, Contractor is responsible for verifying correctness of these and that they relate to the options, accessories, features, etc. marked on the shop drawings. Shop drawings not clearly marked as to only that which will be provided for this Project will not be approved.
- C. In as much as it is not the purpose of the submittal process to assure that the Contractor is meeting all the requirements of the Contract Documents, submittal review by Owner is for conformance with design concept of the Project and general compliance with information given in the construction documents. Approval, corrections and/or comments made as part of the submittal review do not relieve the Contractor of the responsibility from conformance with all requirements of the Contract Documents, applicable codes and laws. Contractor is responsible for dimensions, quantities, and performance requirements to be confirmed and correlated at the job site; for information that pertains solely to the fabrication processes or to techniques of construction; and for all coordination with the Work of all trades. Refer to paragraph entitled “Substitutions” in this section of the specifications.
- D. At the time of each submittal, Contractor shall give Owner specific written notice of such variations, if any, that the Shop Drawing or product submitted may have from the requirements of the Contract Documents, such notice to be in a written communication separate from the submittal; and, in addition, shall cause a specific notation to be made on each Shop Drawing and sample submitted to Owner for review and approval of each such variation. Owner’s review and approval of Shop Drawings or products shall not relieve Contractor from responsibility for any variation from the requirements of the Contract Documents unless Contractor has in writing called the Owner’s attention to each such variation at the time of each submittal and Owner has given written notation thereof incorporated in or

accompanying the Shop Drawing or product approval; nor will any approval by Owner relieve contractor from responsibility for complying with the requirements of this paragraph.

- E. Shop drawing submittals shall be accompanied by a transmittal sheet with the applicable specification section number and the "name" of the item or items being submitted clearly indicated on the transmittal. All "names" on the transmittal shall match exactly the "names" listed in the specifications for the item being submitted.
- F. The name of the supplier, distributor, subcontractor, etc., who will furnish equipment and items to the Contractor shall appear on the shop drawings when submitted. Shop drawing submittals without supplier's, distributors, subcontractors, etc., name will not be reviewed and will be returned without review.
- G. If Owner is required to review any shop drawing or product data submittal more than two times, a Change Order will be issued to the Contractor for a credit due on the Contract Price to recoup Owner's expenses associated with the multiple reviews.
- H. One complete set of approved shop drawings and product data shall be delivered to Owner at completion of Work. Include lists of manufacturer's parts and part numbers.

1.8 COORDINATION – GENERAL

- A. Work shall be governed by requirements set forth in the conditions of the Contract.
- B. Provide all labor, materials, and equipment required by the Contract Documents necessary for completion of the Work of Section 12.
- C. Bidders shall visit the project site to determine actual conditions which will be encountered in completing the work of this project.
- D. Drawings are generally indicative of Work to be installed but may not indicate all bends, fittings, elbows, etc., required to meet conditions. Where items shown on the Drawings, or herein described, are not clearly understood, Bidders shall confer with Owner.
- E. Coordinate Work of Section 12 with that of other trades so that Work will be installed in the most direct manner and so that interference between piping, ducts, conduits, equipment, and architectural or structural features will be avoided. Work installed in an arbitrary manner without regard for Work of other trades or equipment servicing requirements will be rejected in any situation where an undesirable condition or an unfair hardship for other trades, or Owner, results.
- F. Provide sufficient scaffolding and hoist or rig material and equipment into place, or arrange for rigging by others. In any case, rigging or hoisting for Work of Section 12 shall be at the expense of Contractor.
- G. Unless otherwise indicated on the Drawings, provide structural steel members as required for support of equipment and materials furnished under Section 12. Provide all hangers and supports, as specified, detailed, or in accordance with accepted industry standards.

- H. Equipment shall be installed in accordance with equipment manufacturer's installation instructions. Obtain manufacturer's installation instructions prior to roughing-in.
- I. Where equipment is furnished by other trades for installation as Work under Section 12, or where electrical service or utility connection to equipment installed by others is indicated as Work of Section 12, obtain approved shop drawings and installation instructions from the respective contractor prior to roughing-in. Discrepancies between installation instructions and Contract Documents shall be brought to the attention of Owner.
- J. Where equipment is indicated to be furnished as Work of Section 12 for installation by others, or where equipment furnished and installed under Section 12 requires utility connections by others, provide to the respective contractor one copy of an approved shop drawing and installation instructions necessary for execution of his work.
- K. Unless specifically indicated, communication between the mechanical and electrical systems equipment and panels shall be via a dedicated wiring system furnished and installed by the systems installers. These systems shall be separate from all other data communication networks within the building. Contractor may request approval for providing communications on the Owner's building data network. If Owner's written approval is obtained, the system installer shall fully coordinate the necessary data network connections with the Owner, the Owner's technology consultant, and the contractor responsible for installing the building data network system. The systems shall follow the Owner's data network labeling scheme for outlets and jacks, operation protocols, and shall adhere to all network security measures. The system installer shall be responsible for all costs associated with equipment, materials, and labor necessary to furnish and install the communications network including, but not limited to: jacks, wall plates, cables, conduits and boxes, patch panels, patch cords, additional Owner switches and equipment, additional systems equipment, and programming services.

1.9 COORDINATION – NEW CONSTRUCTION

- A. Openings and recesses, including cutting, patching and finishing, necessary for installation of mechanical equipment in new construction will be provided by General Contractor. Coordinate locations, dimensional data, and scheduling of Work with General Contractor.
- B. Where piping is run concealed in concrete masonry unit (block) walls, Contractor shall be responsible for installing his work in cores of block for mason to wall-in as he carries up wall. Coordinate locations and scheduling of Work with General Contractor.
- C. Provide concrete foundation pads for mechanical equipment installed under this Division. Foundations for compressors shall extend through floor slab and be isolated from floor by 1/2 inch thick expansion joint material. Foundations for base mounted pumps and water heaters shall be installed on floor slab. Unless otherwise noted, foundations shall be 4 inches above finished floor and extend a minimum of 2 inches beyond base or bedplate. Inserts and anchor bolts shall be poured into foundation according to equipment manufacturer's instructions. Method of setting, aligning, and anchoring shall be as recommended by equipment manufacturer
- D. General Contractor will furnish and install structural steel members for supporting rooftop equipment. Provide General Contractor with dimensional data required for fabrication of supports.

- E. General Contractor will furnish and install all base flashing for roof mounted equipment. Furnish and install all cap flashing integral to roof mounted equipment and field fabricated. Coordinate with General Contractor's roofer.
- F. Electrical Contractor will wire all motors, resistance coils and controllers, except as noted otherwise in Section 18, Wiring of Mechanical Equipment. Where motor starters and disconnect switches are supplied, and shipped loose with mechanical equipment, they shall be mounted and wired by Electrical Contractor. Verify available power characteristics prior to ordering equipment.

1.10 COORDINATION – EXISTING CONSTRUCTION

- A. Cut all openings required in existing construction for installation of equipment and material. Perform all cutting, patching, and refinishing as required to match surroundings.
- B. Existing Ceilings: Remove existing ceiling tile where required for installation of mechanical Work. Replace ceiling tiles as Work is completed. All damaged or broken ceiling tile caused by Contractor's workers shall be replaced by Contractor at no cost to Owner.
- C. Utility interruptions (including campus heating and chilled water) and tie-ins shall be coordinated with Owner a minimum of 14 days in advance of Work.

1.11 EXCAVATION AND BACKFILL

- A. General Contractor will perform excavation and backfill required for Work of this Division, inside and outside building. Coordinate extent of excavation required with General Contractor.

1.12 PAINTING

- A. Equipment furnished under Section 12 that is pre-painted or pre-finished by manufacturer shall have all nicks, scratches, blemishes, and rust spots cleaned, primed, and refinished prior to final acceptance by Owner.
- B. General Contractor will paint exposed unfinished equipment, piping, ductwork, etc., installed under Section 12.

1.13 EXISTING EQUIPMENT

- A. Removal of Existing Equipment and Materials: Items of value as determined by Owner shall be stored on site where directed by Owner. Equipment and material that Owner does not wish to retain shall be legally disposed of offsite. Do not remove any equipment and materials from the site without Owner's approval.
- B. Relocation of Existing Equipment and Materials: Before reinstallation, equipment shall be cleaned and nicks and scratches shall be touched-up. Broken parts shall be brought to the attention of Owner prior to removal or any disassembly.

1.14 OPERATION AND MAINTENANCE MANUALS

- A. One (1) complete hard copy and 1 soft copy/electronic set(s) on compact disc(s) of the operating and maintenance manual labeled as described herein shall be submitted to the Owner for approval in as many 3-ring loose leaf binders as required. The copies shall be submitted a minimum of two weeks prior to any instructions and demonstrations to Owner's personnel.
- B. The manuals shall be typewritten and the information shall be arranged in a logical order for use by the Owner in maintaining the equipment and systems installed on the project.
- C. The manuals shall include, but not be limited to the following:
 - 1. Table of contents.
 - 2. Materials list with place of purchase.
 - 3. List of normally replaced items, such as filters, fuses, belts, seals, screens, etc., indicating style, rating, size, etc., and place of purchase.
 - 4. Approved copies of submittals, including component wiring diagrams and BAS wiring piping diagrams of all installed systems indicating all connections, color coding, functions, locations, etc. Approved "As-Noted" submittals shall be corrected to incorporate all approval notes prior to inclusion in the manuals.
 - 5. Installation, servicing, maintenance and operating instructions for all systems and components with place of original purchase, and name, address and phone number of person servicing system.

6. Manufacturer's guarantees and warranties.
7. System and equipment start-up, seasonal changeover, and seasonal shut-down with pre-start checklists and precautions.
8. System and equipment troubleshooting guides.
9. Reference documents which shall include construction drawings list, record set of drawings list, test and balance records.
10. Testing and balancing procedures for each system(s) and system(s) components.
11. Copies of all inspection certificates and approvals from all inspection agencies.
12. Copies of approved testing, adjusting and balancing reports.
13. Copy of all Mechanical Vibration Analysis and Alignment Verification Reports.

1.15 SPARE PARTS AND EQUIPMENT

- A. Furnish to Owner spare parts and equipment at project closeout in accordance with each respective specification section that requires spare parts and equipment.

1.16 FINAL PAYMENT AND ACCEPTANCE

- A. Upon written notice that Work is complete and installed in accordance with intent of Specifications, Mechanical Engineer will make a final inspection with Owner and Contractor. If Mechanical Engineer determines that Work is incomplete, or it contains deficiencies, Contractor shall immediately take such measures as are necessary to complete Work or remedy such deficiencies.
- B. Obligations of Contractor, when making application for final payment, are contained in various sections of the Specifications, Addenda or modifications. These obligations consist of furnishing instruction, record drawings, printed material, tools and devices, clean-up services, credit, certificates, valve listings, start-up test reports.
- C. If documentation required does not accompany final payment application, Mechanical Engineer will not accept Work and will advise that final payment is not recommended. Mechanical Engineer will indicate in writing reasons for refusing to recommend final payment.
- D. If, on basis of Mechanical Engineer's observation of Work during construction and final inspection and Mechanical Engineer's review of final application for payment and accompanying documentation, and if Mechanical Engineer is satisfied that Work has been completed and Contractor has fulfilled all obligations, Mechanical Engineer will indicate in writing his recommendation for final payment. If, through

no fault of Contractor, final completion of Work is significantly delayed and if Mechanical Engineer so confirms, Mechanical Engineer will recommend payment to Contractor for that portion of the Work fully completed and accepted.

- E. Contractor is reminded that his obligation is a continuing one to perform and complete Work in accordance with Contract Documents. Neither recommendation of any progress or final payment, nor issuance of Certificate of Substantial Completion, nor any payment to Contractor by Owner, or any use or occupancy of premises or any part thereof by Owner, will constitute an acceptance of Work.

PART 2 - PRODUCTS

2.1 MATERIALS

- A. All materials and equipment shall be new, without imperfections or blemishes, and shall be protected from the elements prior to installation.
- B. Contractor shall be responsible to verify all furnished materials and equipment are suitable for the service, temperatures, and pressures where they are installed.

PART 3 - EXECUTION

3.1 INSTALLATION

- A. Work shall be installed by mechanics skilled in the trade involved.
- B. All mechanical equipment and materials shall be installed to allow access to and to facilitate service, maintenance, repair, replacement, etc., of components to all equipment furnished and installed under this Division of the specifications, furnished and installed under all other Divisions of the specifications, and, where applicable, Owner furnished and installed and Owner's existing equipment.
- C. Duct work, piping, equipment, etc., shall be installed in such a manner as to preserve access to equipment installed under this project and, where applicable, existing equipment.

3.2 CLEANING

- A. Upon completion of Work, remove all dirt, foreign materials, stains, fingerprints, etc., from all parts and equipment.
- B. Remove all construction debris and vacuum interior spaces of all compartmental equipment.
- C. Conduct cleaning and disposal operations to comply with codes, ordinances, regulations and anti-pollution laws.
- D. Work shall be subject to inspection by the Owner.

3.3 PROTECTION FROM DUST AND DEBRIS

- A. During patching, painting, ceiling removal and replacement, working on the ceiling or on things above the ceiling, etc., maintain cloths or suitable building paper covers to protect building surfaces. Protective measures (drop cloths, protective covers, etc.) shall be placed and sealed over all furniture and equipment to keep items clean and protected against dirt, dust and debris from entering furniture and equipment that the Owner has not removed.
- B. Upon completion of work each day when building is occupied, remove all temporary covers, drop cloths and debris and vacuum clean all worked-in areas to eliminate carrying of dirt materials and dirt tracking throughout building during times construction is not proceeding.

3.4 CONSTRUCTION SEQUENCE

- A. The work shall proceed in accordance with the construction work sequence narrative as issued in Division 01.
- B. Work to be installed through existing building shall be installed at other than normal occupied hours. Coordinate installation times with Owner. Contractor shall be responsible for removing and replacing ceilings for installing items above ceilings in these existing areas. All ceilings removed shall be replaced prior to normal occupied hours.

3.5 OPERATING INSTRUCTIONS

- A. Engage qualified instructors to instruct Owner's personnel to adjust, operate, and maintain systems, subsystems, and equipment not part of a system.
- B. Provide instruction at mutually agreed on times. Schedule training with Owner with at least seven days' advance notice.
- C. Instructor shall operate system(s) in order to demonstrate fulfillment of contract requirements and educate Owner's personnel on the following:
 - 1. Basis of system design and operational requirements.
 - 2. Documentation provided in the operating and maintenance manuals.
 - 3. Startup and normal operation instructions.
 - 4. Warning, trouble indications, emergency operation and failure instructions.
 - 5. Adjustments.
 - 6. Inspection and preventative maintenance.
 - 7. Diagnostics and repairs.

3.6 WARRANTIES

- A. Where extended warranties beyond the normal one-year warranty are, as specified herein, to be applied to a particular item of equipment or system, furnish to Owner a description of the

warranty along with any required registration and signature of manufacturer's authorized personnel.

- B. Contractor shall be responsible for coordinating with and having the manufacturer administer these warranties for the full extent of time the warranty will be in effect.
- C. Contractor shall be responsible for administering and servicing all extended warranties for the life of each extended warranty at no additional cost to Owner. Owner's responsibility will be for additional costs for parts associated with warranties that are warranted on a pro-rated basis. All labor for administering and servicing the extended warranty, including actual replacement of parts, will be the responsibility of the Contractor for the extended warranty period. All unwarranted shipping and handling costs for parts and equipment will be the responsibility of the Owner.

****END OF SECTION****

**SECTION 120020
PLUMBING BASIC MATERIALS**

PART 1 - GENERAL

1.1 WORK INCLUDED

- A. The Work of this Section shall consist of the labor, materials and equipment required for the installation of basic materials and motors associated with plumbing systems.

1.2 SUBMITTALS

- A. Submit for approval in accordance with specified submittal procedures:
1. Access Panels
 2. Fire Stop Sealing System
 3. Equipment Nameplates; including itemized listing of nameplate equipment designations
 4. Motors; submit with each piece of equipment

PART 2 - PRODUCTS

2.1 ACCESS PANELS

- A. Access Panel Specification No. 1
1. Acceptable Manufacturer: Milcor Style AP for acoustical plaster, Style AT for acoustical tile, or Karp, Krieger, Bilco.
 2. Type: Acoustical ceiling.
 3. Construction: 16 gage galvanized steel frame, 18 gage galvanized steel panel. Recessed to accommodate acoustical ceiling tile. Continuous hinge, steel with stainless steel pin.
 4. Closing Feature: Flush, screw driver operated lock with steel cam.
- B. Access Panel Specification No. 2
1. Acceptable Manufacturer: Milcor Style DW, or Karp, Krieger, Bilco.
 2. Type: Gypsum wallboard.
 3. Construction: 16 gage steel frame, 14 gage steel panel.
 4. Concealed spring hinges. Prime coat finish for field painting.
 5. Closing Feature: Flush, screwdriver operated lock with steel cam.
- C. Access Panel Specification No. 3
1. Acceptable Manufacturer: Milcor, or Karp.

2. Type: Fire rated.
3. Construction: 16 gage steel frame, 20 gage steel panel.
4. Continuous hinge with stainless steel pin. Automatic panel closer. Factory attached masonry anchors.
5. Rating: UL listed 1 1/2 hour (B label), temperature rise 30 minutes, 250 degrees F. maximum.
6. Closing Feature: Self latching lock, direct action knurled knob, interior latch release mechanism.

D. Access Panel Specification No. 4

1. Acceptable Manufacturer: Milcor Style M, or Karp, Krieger, Bilco.
2. Type: Masonry, tile, or wood.
3. Construction: 16 gage frame, 14 gage panel. Concealed spring hinges. Prime coat finish for field painting or stainless steel, satin finish, as required.
4. Closing Feature: Flush screwdriver operated lock with steel cam.

E. Access Panel Specification No. 5

1. Acceptable Manufacturer: Milcor Style K, or Karp, Krieger, Bilco.
2. Type: Plastered surfaces.
3. Construction: 16 gage frame, 14 gage panel. Concealed spring hinges. Prime coat finish for field painting.
4. Closing Feature: Flush, screwdriver operated lock with steel cam.

2.2 FIRE STOP SEALING SYSTEM

- A. Acceptable Manufacturer: Nelson Firestop Products CLK Silicone Sealant, or 3M Fire Protection Products, RectorSeal, Specified Technologies (STI), Tremco.
- B. Materials: Single component, ready-to-use, water-resistant, flexible elastomeric silicone sealant. Non-sag/gunnable grade for penetrations in vertical surfaces, self-leveling grade for floor applications.
- C. Compliance: Fire endurance tested per ASTM E-814 (UL 1479). In addition to compliance as a fire stop, the cured sealing system shall not permit smoke or water penetration.

2.3 EQUIPMENT NAMEPLATES

- A. Laminated phenolic, two outer layers of white phenolic and an inner layer of black with engraving depth to the inner layer.
- B. Nameplates for non-powered equipment and equipment connected to normal power circuits shall be laminated phenolic with two outer layers of black phenolic and an inner layer of white with engraving depth to the inner layer. Nameplates for equipment connected to normal-emergency power circuits shall have red outer layers.

- C. Nameplate and lettering suitably sized for their location, but not less than 1/4 inch high letters.

2.4 MOTORS

- A. Acceptable Manufacturers: Baldor, Reliance, Toshiba, US Motor (Emerson), or Weg. No substitutions.

- B. Motor Characteristics:

1. Duty: Continuous duty at ambient temperature of 40 degrees C and at an altitude of 3300 feet above sea level.
2. Capacity and Torque Characteristics: Sufficient to start, accelerate, and operate connected loads at designated speeds, at installed altitude and environment, with indicated operating sequence, and without exceeding nameplate ratings or considering service factor. Horsepower rating shall not be less than size indicated on Drawings.

- C. Three Phase Motors:

1. Description: NEMA MG 1, Design B, medium induction motor.
2. Efficiency: Premium efficiency, as defined by NEMA MG 1.
3. Voltage: As indicated on Drawings.
4. Service Factor: 1.15.
5. Insulation: NEMA Class F.
6. Sound Power Levels: Conform to NEMA MG 1.
7. Bearings: Grease lubricated anti-friction ball bearings with housings equipped with plugged provision for re-lubrication, rated for minimum AFBMA 9, L-10 life of 200,000 hours.
8. Thermal Protection: Internal, automatically reset.
9. Motors Used with Variable Frequency Drives:
 - a. Windings: Copper magnet wire with moisture-resistant varnish, designed and tested to resist transient spikes, high frequencies, and short time rise pulses produced by pulse-width modulated inverters.
 - b. Premium-Efficient Motors: Class B temperature rise; Class F insulation.
 - c. Inverter-Duty Motors: Class F temperature rise; Class H insulation.
 - d. Shaft grounding ring.

- D. Single Phase Motors:

1. Larger Than 1/20 HP: One of the following, to suit starting torque and requirements of specific motor applications:
 - a. Permanent-split capacitor.
 - b. Split phase.
 - c. Capacitor start, inductor run.
 - d. Capacitor start, capacitor run.
2. Motors 1/20 HP and Smaller: Shaded-pole type. Multispeed Motors: Variable-torque, permanent-split-capacitor type.

- 3. Voltage: As indicated on Drawings.
 - 4. Bearings: Prelubricated, antifriction ball bearings or sleeve bearings.
- E. Thermal Protection: Internal, automatically reset.

PART 3 - EXECUTION

3.1 INSTALLATION

A. Access Panels

- 1. Furnish and install access panels in ceilings and walls for service and repair access to concealed equipment, including, but not limited to:
 - a. Valves: hand operated and automatic
 - b. Backflow preventers
 - c. Gages and thermometers
 - d. Water hammer arresters
 - e. Pressure regulating/reducing valves
- 2. Minimum Size: 18 inches by 18 inches. Where restrictions will not permit minimum size, verify access panel size with Architect.
- 3. Provide access panels in accordance with the following schedule:

ACCESS PANEL SCHEDULE	
Application	Access Panel Spec. No.
Acoustical tile or acoustical plaster finishes	1
Gypsum board (dry wall) finishes	2
Fire rated walls	3
Masonry, tile, or wood finishes	4
Plastered finishes	5

- 4. Access panel location(s) that are indicated on drawings are of a specific concern. However, Contractor shall be responsible to furnish and install access panels as required.

B. Sleeves and Plates

- 1. Furnish and install sleeves for all pipes passing through floors, walls, partitions, slabs, grade beams and foundations.
- 2. Layout, size, and locate sleeves such that they be set and installed prior to pouring concrete, or when masonry is being constructed. In event sleeves must be placed after floor, wall, grade beam, etc., has been constructed, submit in writing to and obtain

approval from Owner on location, quantity and proposed method of core drilling and installing.

3. Core drilled openings above grade in solid concrete need not be sleeved but must be clean and neat without cracking or spalling.
4. Sleeves shall be standard weight galvanized steel pipe having square cut ends with anchoring lugs welded on. Horizontal sleeves through walls, grade beams, foundations, and partitions shall be flush with finished wall faces. Vertical sleeves through floors shall extend 2 inches above finished floor and be flush with finished ceiling or underside of floor construction. Sleeves in pits or below grade shall be painted or coated with one coat of coal tar pitch paint.
5. Size sleeves such that internal diameter is 2 pipe sizes or a minimum of 2 inches larger than outside diameter of bare pipe for uninsulated lines and 2 inches larger than outside diameter of insulation and jacket for insulated lines. Center pipes in sleeves.
6. For pipes passing through floors, slabs, walls, grade beams, or foundations at or below grade and in pits, the annular space between outside of pipe or insulation and inside of sleeve shall be packed with a pliable, non-hardening waterproof mastic sealer or a cement base quick set repair mortar.
7. For pipes passing through walls and floors above grade and with no fire or smoke rating, the annular space between outside of pipe or insulation and inside of sleeve or concrete shall be packed tight with batt type fiberglass insulation.
8. For pipes passing through walls and floors above grade with smoke or fire rating of one hour or more, the annular space between outside of pipe and insulation and inside of sleeve or concrete shall be sealed with fire stop sealing system.

C. Fire Stop Sealing System

1. All floor and interior wall penetrations with smoke or fire rating of one hour or more shall be sealed. Refer to architectural drawings for locations of fire rated floors and walls.
2. Prepare penetration and install sealing material in accordance with the manufacturer's recommendations.
3. Through penetration fire stop sealing systems shall be identified on both sides with permanently mounted, preprinted vinyl labels which include the following information:
 - a. The words "Warning: Through Penetration Firestop System – Do Not Disturb" or similar phrase.
 - b. Manufacturer's brand name, product type or catalog number
 - c. Testing agency designation and rating
 - d. Installer's Name
 - e. Installation Date

D. Equipment Nameplates

1. Furnish and install a full complement of nameplates for all items of mechanical equipment installed as Work of this Division, including water heaters, pumps, mixing valves and control panels.
2. Install nameplates parallel to equipment lines.
3. Unless noted, nameplates shall be attached with sheet metal screws or epoxy cement. Epoxy cement shall not be used equipment installed outdoors.

4. Coordinate with Owner for nameplate designations. Submit a complete itemized listing of nameplate equipment designations for approval.
5. Prior to fabricating nameplates, complete and submit a listing for all installed central plumbing system equipment. Nameplates shall include the following information:
 - a. Unit #
 - b. Date unit put in service
 - c. Contractor
 - d. Manufacturer
 - e. Model #
 - f. Serial #

****END OF SECTION****

**SECTION 120030
PLUMBING PIPE AND PIPE FITTINGS**

PART 1 - GENERAL

1.1 WORK INCLUDED

- A. The Work of this Section shall consist of the labor, materials and equipment required for the installation of plumbing piping and pipe fittings.

PART 2 - PRODUCTS

2.1 PIPE AND PIPE FITTINGS

- A. Pipe shall conform to the materials specified herein, and shall be installed for piping systems as scheduled in Part 3 – Execution, of this Section.

2.2 TYPE L COPPER PIPE SPECIFICATION NO. 1

- A. Design Pressure: 150 psig.
- B. Maximum Design Temperature: 200 degrees F.
- C. Sizes 2 inches and smaller:
 - 1. Tubing: Type L hard drawn seamless copper tube, ASTM B88.
 - 2. Joints: Solder type with 95-5 solder, or press coupled.
 - 3. Fittings: Wrought copper solder joint, ANSI B16.22 or cast bronze solder joint, ANSI B16.18, or with EPDM O-rings, ASME B16.18 or ASME B16.22.
- D. Sizes 2 1/2 inches and larger:
 - 1. Tubing: Type L hard drawn seamless copper tube, ASTM B88.
 - 2. Joints: Flanged and solder type with 95-5 solder, or press coupled.
 - 3. Fittings: Wrought copper solder joint, ANSI B16.22 or cast bronze solder joint, ANSI B16.18, or wrought copper press coupled joint. ANSI B16.22.
 - 4. Flanges: 150 lb. class cast bronze, ANSI B16.24.

2.3 TYPE K COPPER UNDERGROUND PRESSURE PIPE SPECIFICATION NO. 2

- A. Design Pressure: 150 psig.
- B. Maximum Design Temperature: 150 degrees F.

- C. Sizes 2 inches and smaller:
 - 1. Tubing: Type K hard drawn seamless copper tube, ASTM B88.
 - 2. Joints: Solder type with 95-5 solder.
 - 3. Fittings: Wrought copper solder joint, ANSI B16.22 or cast bronze solder joint, ANSI B16.18.
- D. Sizes 2 1/2 inches and 3 inches:
 - 1. Tubing: Type K hard drawn seamless copper tube, ASTM B88.
 - 2. Joints: Flanged and solder type with 95-5 solder.
 - 3. Fittings: Wrought copper solder joint, ANSI B16.22 or cast bronze solder joint, ANSI B16.18.
 - 4. Flanges: 150 lb. class cast bronze, ANSI B16.24.
- E. Pipes penetrating building floors on grade or building walls or pit walls below grade shall be ductile iron. Refer to Ductile Iron Pressure Pipe Specification No. 6.

2.4 SERVICE WEIGHT CAST IRON PIPE SPECIFICATION NO. 3

- A. Approvals: Cast iron soil pipe and pipe fittings shall be marked with the collective trademark of the Cast Iron Soil Pipe Institute (CISPI) and shall be listed by NSF International.
- B. Design Pressure: Gravity.
- C. Maximum Design Temperature: 180 degrees F.
- D. All Pipe Sizes:
 - 1. Pipe & Fittings
 - a. Below Grade: Service weight cast iron soil pipe, tar coated inside and outside, ASTM A74.
 - b. Above Grade: Hubless cast iron soil pipe, tar coated inside and outside, CISPI Standard 301, ASTM A888.
 - 2. Joints
 - a. Below Grade: Hub and spigot, compression.
 - b. Above Grade: Hubless.
 - 3. Adapters: Transitions from cast iron soil pipe to another pipe material shall be made with Fernco Joint Sealer Company PVC Donut adapters, or approved equal. Hubless transitions shall be made with an approved, shielded coupling for the purpose and material.
- E. Vent Flashing: By General Contractor.

2.5 TYPE DWV COPPER PIPE SPECIFICATION NO. 4

- A. Design Pressure: Gravity.

- B. Maximum Design Temperature: 180 degrees F.
- C. Sizes 1-1/4 inches through 4 inches:
 - 1. Pipe: Type DWV hard temper seamless copper drainage tube, ASTM B306.
 - 2. Joints: Solder. ASTM B32, Grade 50B.
 - 3. Fittings: Cast bronze solder joint drainage type, ANSI B16.23 or wrought copper solder joint drainage type, ANSI B16.29.
- D. Vent Flashing: By General Contractor.

2.6 SCHEDULE 40 GALVANIZED STEEL PIPE SPECIFICATION NO. 5

- A. Design Pressure: Gravity.
- B. All Sizes:
 - 1. Pipe: Schedule 40 galvanized steel, threaded and coupled, ASTM A53.
 - 2. Joints: Threaded, ASTM B16.3.
 - 3. Fittings: Galvanized cast iron screwed drainage type, ANSI B16.4.
- C. Vent Flashing: By General Contractor.

2.7 SCHEDULE 40 BLACK STEEL PIPE SPECIFICATION NO. 8

- A. Design Pressure: 150 psig.
- B. Maximum Design Temperature: 350 degrees F.
- C. Sizes 2-1/2 inches and smaller:
 - 1. Pipe: Schedule 40 black steel, threaded and coupled, ASTM A53.
 - 2. Joints: Threaded. (Exception: All gas piping installed in steel conduits; all gas conduit and conduit vent pipe; all black steel pipe installations below ground; shall be continuous butt weld joints.)
 - 3. Fittings: 150 lb (S) 300 lb (WOG) black malleable iron.
 - 4. Unions: 250 lb (S) 500 lb (WOG) black malleable iron, ground joint with brass seat.
- D. Sizes 2-1/2 inches and larger:
 - 1. Pipe: Schedule 40 black steel, beveled ends, ASTM A53.
 - 2. Joints: Butt welded and flanged.
 - 3. Fittings: Schedule 40 seamless steel, butt weld type, ASTM A234.
 - 4. Flanges: 150 lb forged steel, welding neck or slip on, ASTM A181 Class 60.
- E. All piping installed below ground shall have factory applied coal tar coating. Below ground joints shall have a field applied coal tar coating.

2.8 REINFORCED CONCRETE PIPE SPECIFICATION NO. 9

- A. Design Pressure: Gravity.
- B. Maximum Design Temperature: 160 degrees F.
- C. Round Pipe, Sizes 10 inches and larger:
 - 1. Pipe: Reinforced concrete, Class III with tongue and groove ends, ASTM C76.
 - 2. Joints: Flexible, water tight rubber gaskets, ASTM C443.
 - 3. Adapters: Transitions from another material to concrete pipe shall be made with Fernco Joint Sealer Company PVC Donut adapters.
- D. Elliptical (Oval) Culverts, All Pipe Sizes:
 - 1. Pipe: Reinforced concrete, HE Class III with tongue and groove ends, ASTM C507.
 - 2. Joints: Mortar, tongue and groove.
 - 3. Socket, factory threaded or flanged solvent cement.

2.9 SCHEDULE 40 PVC PIPE SPECIFICATION NO. 13

- A. Design Pressure: Gravity.
- B. Maximum Design Temperature: 150 degrees F. at continuous flow.
- C. All Pipe Sizes:
 - 1. Schedule 40, polyvinyl chloride (PVC), ASTM D2665 with NSF seal.
 - 2. Fittings: Schedule 40, polyvinyl chloride, DWV pattern, ASTM D2665 with NSF seal.
- D. Sizes: 2 inches and smaller:
 - 1. Joints: Socket or factory threaded solvent cement ASTM D2564.
- E. Sizes: 2-1/2 inches or larger:
 - 1. Joints: Socket or flanged solvent cement ASTM D2564.
- F. Vent Flashing: By General Contractor.

2.10 SCHEDULE 40 ABS PIPE SPECIFICATION NO. 16

- A. Design Pressure: Gravity.
- B. Maximum Design Temperature: 180 degrees F. at continuous flow.
- C. All Pipe Sizes:
 - 1. Pipe: Schedule 40, acrylonitrile butadiene styrene (ABS), ASTM D2661 with NSF seal.
 - 2. Fittings: Socket or factory threaded solvent cement, ASTM D2235.

D. Vent Flashing: By General Contractor.

2.11 ACID RESISTENT POLYPROPYLENE PIPE SPECIFICATION NO. 20

A. Design Pressure: Gravity.

B. Maximum Design Temperature: 150 degrees F.

C. All Pipe Sizes:

1. Pipe & Fittings: Schedule 40, Type II acid resistant polypropylene compound with no reprocess or reclaim materials added, ASTM. Fittings shall conform in dimensions to normally accepted plumbing fittings and shall meet all requirements of local plumbing codes.
2. Joints: Joints shall be socket welded using only electric socket welding tools.

PART 3 - EXECUTION

3.1 APPLICATION

A. Piping systems shall be installed in accordance with the following pipe schedule(s).

PIPE SCHEDULE*		
Service	Application	Pipe Spec. No.
Dom. Cold Water	Above Grade	1
	Below Grade	2
Dom. Hot Water	Above Grade	1
Dom. Hot Water Recirculating	Above Grade	1
Dom. Water Pipe Connections to Water Heaters	All	1
Sanitary	Above Grade	3, 4, 13 or 16
	Below Grade, within bldg.	3, 13 or 16
Sanitary Vent	Above Grade	3, 4, 5, 13 or 16
	Below Grade	3, 13 or 16
Storm Drainage	Above Grade	3, 13 or 16
	Below Grade, within bldg.	3, 9, 13, 16
Propane Gas	Above Grade	8
	Below Grade, within bldg.	8
Compressed Air	All	8
Vacuum	All	1

PIPE SCHEDULE*

Service	Application	Pipe Spec. No.
Acid Waste	All	20

* Where plastic piping is used, it shall be the Contractor's responsibility to ensure compatibility of the installed piping system with the building's HVAC system. Where plenum rated materials are required by any federal, state, or municipal authority's construction codes, plastic piping shall be covered in its entirety by an approved fire retardant insulating material. Fire retardant insulating systems shall be certified to meet ASTM E-84 and UL 723 standards for flame spread and smoke generation. Fire retardant insulating systems shall be approved by the Authority Having Jurisdiction prior to installation.

3.2 INSTALLATION

- A. Contractor shall carefully follow the Drawings in laying out and installing his work and he shall not deviate therefrom, except for structural or interior finish interferences.
- B. All pipe and fittings shall be carefully inspected for defects in workmanship prior to installation. Any item found unsuitable, cracked, or otherwise defective shall be rejected and removed from the jobsite. All pipe and fittings shall have factory applied markings, stampings, or nameplates with sufficient data for identification to determine their conformance with specified requirements.
- C. Plastic piping shall be installed in strict accordance with pipe manufacturer's recommendations and in accordance with the recommendations of the Plastic Pipe Institute. Protect plastic piping from damage by adjacent sharp surfaces with rubber or plastic grommets or sleeves.
- D. During construction all openings in piping shall be kept closed except when actual work is being performed on that item. Closures shall be plugs, caps, blind flanges, or other items specifically intended for this purpose. Exercise all necessary care to prevent foreign objects from entering material.
- E. Run pipe lines straight and true, parallel to building lines with a minimum use of offsets and couplings. Use full and double lengths of pipe wherever possible.
- F. Changes in direction shall be made only with pipe bends or fittings. Changes in size shall be made with fittings only. All fittings shall be of the long radius type, unless otherwise specified. Changes in direction on drainage pipe systems shall be made with wye fittings, combination wye and eighth bends, or one eighth bends. Offset in soil or waste pipes will not be permitted where avoidable. Offsets shall be made with 45 degree bends or similar fittings.
- G. Provide flanges or unions at all final connections to equipment and valves to facilitate dismantling.
- H. Unless otherwise indicated, install all piping to pumps and other equipment at line size with reduction in size being made only at inlet to pump or equipment connection.

- I. All pipe shall be cut to exact measurement, and installed without springing or forcing. Particular care shall be taken to avoid creating, even temporarily, undue loads, forces or strains on valves, equipment or building elements with piping connections or piping supports.
- J. Install bell and spigot pipe, such that spigot ends point in direction of flow.
- K. Unless otherwise indicated, branch take offs shall be from top of mains or headers at either a 45 degree or 90 degree angle from the horizontal plane for air and gas lines, and from top, bottom or side for liquids.
- L. Pipe joints connecting dissimilar metals shall be insulating, dielectric connections. Copper tubing shall be protected from electrolysis at contact points with ferrous metals, including temporary methods of support, by use of insulating, non conductive spacers such as rubber, fiberglass or an approved equal. Pipe hangers for bare copper tubing shall be copper plated.

3.3 PIPE JOINTS

- A. Heavy-duty No-hub Coupling: Heavy duty coupling shall conform to the requirements of ASTM C1540 with AISI 304 stainless steel bi-directional corrugated shield with AISI 304 stainless steel clamps and screw housing. Gasket shall conform to ASTM C564.
- B. Compression Joints, Hub and Spigot Soil Pipe: Joint shall be one piece double seal compression type gasket made specifically for joining cast iron soil pipe. The gasket shall be neoprene material, permitting joint to flex as much as 5 degrees without loss of seal. Gasket shall be extra heavy conforming to ASTM C564 and ASTM C1563. Installation shall be in accordance with manufacturer's published instructions.
- C. Press Coupled Joints: Copper press fittings in copper domestic water pipe, types L and K, shall be a NSF-61, ASME B16.22 and ASTM B88 approved external compression system. System shall be rated to hold 200 PSI working pressure with a temperature range from 0 degrees Fahrenheit to 250 degrees Fahrenheit. System may be rated for installation on wet or dry piping for sizes 1/2 inch to 4 inch diameter. Fittings shall be properly cleaned prior in accordance with manufacturer's recommendations prior to installation.
- D. Solder Joints: Make up joints with 95 percent tin and 5 percent antimony (95-5) solder conforming to ASTM B32 Solder Metal, Grade 95TA. Cut copper tubing so ends are perfectly square and remove all burrs inside and outside. Thoroughly clean sockets of fittings and ends of tubing to remove all oxide, dirt, and grease just prior to soldering. Apply flux evenly, but sparingly, over all surfaces to be joined. Heat joints uniformly to proper soldering temperature so solder will flow to all mated surfaces. Wipe excess solder, leaving a uniform fillet around cup of fitting. Flux shall be non acid type. Remove composition discs from solder end valves during soldering.
- E. Welded Joints: The welding of all pipe joints, both as to procedures and qualification of welders, shall be in accordance with Section IX, ASME Boiler & Pressure Vessel Code, unless mandatory local codes take precedence. Ends of pipe and fittings to be joined by butt welding shall be beveled, cleaned to bare metal and internal diameters aligned before tack welding.
- F. Threaded Joints: Pipe screw threads shall conform to ANSI B16.3, Malleable Iron Threaded Fittings or ASTM B687, Brass, Copper, and Chromium Plated Pipe Nipples. Ream pipe ends

and remove all burrs and chips formed in cutting and threading. Protect plated pipe and brass valve bodies from wrench marks when making up joint. Apply thread lubricant to male threads only.

- G. Flanged Joints: Steel pipe flanges shall conform to ANSI B16.5, Steel Pipe Flanges and Flanged Fittings. Cast iron pipe flanges shall conform to ANSI B16.1, Cast Iron Flanges and Flanged Fittings. Steel flanges shall be raised face except when bolted to flat cast iron flange. Bolting for services up to 500 degrees F. shall be ASTM A307, Grade B with square head bolts and heavy hexagonal nuts conforming to ANSI B18.2.1, Square and Hex Bolts and B18.2.2, Square and Hex Nuts. Set flange bolts beyond finger tightness with an indicating torque wrench to insure equal tension in all bolts. Tighten bolts such that those 180 degrees apart or directly opposite are torqued in sequence. Gaskets for flat face flanges shall conform to requirements for Group I Gaskets in ANSI B16.5. Unless otherwise specified, gaskets shall be 3/32 inch thick.
- H. Solvent Cement Joints: Socket joints in PVC, ABS, etc., pipe shall be made by using a manufacturer's recommended solvent cement suitable for respective pipe (CPVC, PVC, ABS, Schedule 40, Schedule 80) and conforming to ASTM D2564. Follow manufacturer's instructions for handling and cementing procedures. Wipe off excess cement fillet around socket. Do not move pipe while cement is setting.
- I. Factory Threaded Solvent Cement Joints: Factory threaded solvent cement joints for plastic pressure piping systems shall be made in accordance with manufacturer's recommendations. The threads should be lubricated with a non-hardening pipe dope or wrapped with Teflon tape.

****END OF SECTION****

**SECTION 120040
PLUMBING PIPING SPECIALTIES**

PART 1 - GENERAL

1.1 WORK INCLUDED

- A. The Work of this Section shall consist of the labor, materials, and equipment required for the installation of plumbing piping specialties.

1.2 SUBMITTALS

- A. Submit for approval in accordance with specified submittal procedures:
 - 1. Branch Connections
 - 2. Pipe & Valve Identification
 - 3. Expansion Compensators, Pipe Guides, Anchors
 - 4. Dielectric Connections
 - 5. Thermometers
 - 6. Pressure Gages

PART 2 - PRODUCTS

2.1 BRANCH CONNECTIONS

- A. Branch connections shall be made with standard tee of the type required for the service unless otherwise specified or detailed.
- B. At Contractor's option, branch connections from headers and mains may be cut into black steel pipe using forged weld on fittings. Weld on fittings shall conform to chemical and physical requirements of ASTM A 234 and design and installation requirements of ANSI B31.1.
- C. Weld on fittings shall have a pressure rating equal to, or greater than, the maximum working pressure of the pipe system where they are installed.
 - 1. Acceptable Manufacturer: Allied Piping Products Co. Branchlets (Shaped nipples), or Bonney Forge Weldolet & Thredolet
- D. At Contractor's option, branch connections from headers and mains may be cut into copper to be using mechanically extracted collars. Collars shall be formed in a continuous operation consisting of drilling a pilot hole and drawing out the tube surface to form a collar having a height of not less than three times the thickness of the tube wall. Main pipe shall be vacuumed to clear all debris during collar forming procedure. Branch pipe shall be notched to conform with the inner curve of the run tube and dimpled to insure penetration of the branch pipe into the

collar at sufficient depth for brazing. All joints shall be brazed. Mechanical formed branch collars shall be UL listed.

1. Acceptable Manufacturer: T Drill, Division of Serlachius.

2.2 ESCUTCHEON PLATES

- A. Plates shall be installed on all pipes and conduit passing through floors, walls, partitions, etc., in exposed areas.
- B. Plates installed on pipe passing through core drilled openings in solid concrete without sleeves shall be solid ring, cast iron with one set screw for sizes up to 4 inches and two set screws for sizes up to 8 inches.
- C. Plates installed on pipe and conduit passing through openings with sleeves shall be solid ring, cast iron.

2.3 PIPE AND VALVE IDENTIFICATION

- A. Acceptable Manufacturer: W. H. Brady Company, or Seton Nameplate Corp., Brimar Industries.
- B. Shutoff valves and control equipment shall be marked by means of a brass or plastic disc minimum of 1 inch in diameter fastened to valve wheel or stem by brass wire or chain. Each disc shall have a legibly marked identification number. A typewritten chart listing all valve tags, location, and service shall be included in the operating and maintenance manual. The valve chart numbering sequence shall be approved by Owner. Existing valve tags on valves to be replaced shall be reinstalled on the new valve. Existing valve tags on valves to be removed shall be turned over to Owner.
- C. All piping installed as Work of this Division shall be identified by legend and flow arrow. Identification system shall conform to ANSI A13.1. Identification markers shall use ANSI standard background colors and text size. Markers shall be attached to pipe by wrapping with color coded banding tape. Markers shall be located as follows:
 1. Near each valve and control device.
 2. Near each branch connection, excluding short takeoffs for fixtures and terminal units. Where flow pattern is not obvious, mark each pipe at branch.
 3. Near penetrations through walls, floors, ceilings, and non-accessible enclosures.
 4. At access doors, manhole, and similar access points that permit view of concealed piping.
 5. Near major equipment items and other points of origination and termination.
 6. Spaced at maximum intervals of 25 feet along each run.

2.4 EXPANSION COMPENSATORS, GUIDES, ANCHORS

- A. Expansion Compensator Type EXC-2
 1. Acceptable Manufacturer: Flexonics, or Keflex, Metraflex, Hyspan.

2. Compensators shall be suitable for absorbing expansion and contraction in copper pipe 3 inches and smaller. Compensators shall be constructed with two ply phosphor bronze or stainless steel bellows, brass shroud, and threaded end fittings.
 3. Units shall have internal guides, internal anti torque device, positioning clip, 150 psi maximum working pressure up to 1 inch pipe size, 125 psi over 1 inch pipe size, 400 degrees F maximum operating temperature, and 2 inch stroke.
 4. degrees F. (welded end fitting, 800 degrees F. flanged end fitting). Stroke as listed on Drawings.
- B. Provide dielectric flanges where compensators are used with copper pipe.
- C. Pipe Guides
1. Acceptable Manufacturer: Flexonics Pipe Alignment Guides, or Keflex, Metraflex, Hyspan.
 2. Pipe guides shall be installed as scheduled on the Drawings in accordance with manufacturer's recommendations. Guides shall consist of steel segmented spider, sized to the OD of the pipe, and free to move axially in a segmented steel cylinder. Guides shall be securely attached to the building structure.
- D. Pipe Anchors
1. Anchors shall be installed in accordance with pipe guide manufacturer's and expansion compensator manufacturer's recommendations. Anchors shall securely attach the piping system to the building structure.

2.5 DIELECTRIC CONNECTIONS

- A. Pipe joints connecting dissimilar metals shall be insulating, dielectric connections. Dielectric connections shall also be furnished for joining similar metals in order to isolate cathodically protected pipelines from adjoining pipe sections. Such joints, including dielectric material, shall be rated to withstand the temperature, pressure, and other characteristics of the service for which it is to be used, including testing pressure.
- B. Screwed joints shall be made with insulating unions.
1. Acceptable Manufacturer: Watts, or Stockham Valves & Fittings.
- C. Flanged joints shall be made up with insulating gaskets, bolt sleeves, and washers.
1. Acceptable Manufacturer: Watts.

2.6 THERMOMETERS

- A. Acceptable Manufacturer: Terice, or Weiss, Miljoco.
- B. Thermometers shall be installed where indicated on the Drawings. Thermometers shall be 9 inch scale with 9 3/4 inch cast aluminum case, acrylic window, liquid-filled, and separable socket. Socket shall be installed in path of water flow. Indication of operating temperature shall

read in middle third of scale. Thermometers installed 7 feet or more above floor shall be adjustable type.

2.7 PRESSURE GAGES

- A. Acceptable Manufacturer: Trerice, or Weiss, Miljoco.
- B. Pressure gages shall be installed where indicated on the Drawings. Gage shall have a 4 inch diameter dial with indication of operating pressure read in middle third of scale. Gages shall have phosphor bronze tube, bronze brushed movement, cast aluminum case with black finish, and an accuracy of 1 percent of scale range. Pressure gage shall be provided with pigtail and stop, and shall be installed vertically.

PART 3 - EXECUTION

3.1 INSTALLATION

- A. Contractor shall carefully follow the Drawings in laying out and installing his work. He shall not deviate therefrom, except for structural or interior finish interferences.
- B. All equipment and accessories shall be carefully inspected for defects in workmanship prior to installation. Any item found unsuitable, cracked, or otherwise defective shall be rejected and removed from the jobsite. All equipment shall have factory applied markings, stampings, or nameplates with sufficient data for identification to determine their conformance with specified requirements.
- C. Piping specialties shall be installed in accordance with the equipment manufacturer's recommendations.
- D. During construction all openings in equipment shall be kept closed except when actual work is being performed on that item. Closures shall be plugs, caps, blind flanges, or other items specifically intended for this purpose. Exercise all necessary care to prevent foreign objects from entering material.
- E. Provide flanges or unions at all final connections to equipment to facilitate dismantling.
- F. Unless otherwise indicated, branch take offs shall be from top of mains or headers at either a 45 degree or 90 degree angle from the horizontal plane for air, or gas lines and from top, bottom, or side for liquids.
- G. Pipe joints connecting dissimilar metals shall be insulating dielectric connections. Copper tubing shall be protected from electrolysis at contact points with ferrous metals, including temporary methods of support, by use of insulating non-conductive spacers such as rubber, fiberglass, or an approved equal. Pipe hangers for bare copper tubing shall be copper plated.

END OF SECTION

**SECTION 120050
PLUMBING SPECIALTIES**

PART 1 - GENERAL

1.1 WORK INCLUDED

- A. The Work of this Section shall consist of the labor, materials and equipment required for installation of the domestic water systems and associated specialties.
- B. Domestic water shall be distributed to all fixtures and equipment. Mains shall be valved and capped for extension and use by Owner, where indicated.
- C. Domestic water supply shall be extended from existing system.

1.2 SUBMITTALS

- A. Submit for approval in accordance with specified submittal procedures:
 - 1. Hydrants
 - 2. Hose Bibbs
 - 3. Water Hammer Arresters
 - 4. Thermostatic Mixing Valves
 - 5. Temperature-Pressure Relief Valves
 - 6. Vacuum Breakers
- B. Submit written verification of testing procedures specified herein.

PART 2 - PRODUCTS

2.1 HYDRANTS

- A. Wall Hydrant WH-1
 - 1. Acceptable Manufacturer: J. R. Smith, or Zurn, Wade, Josam.
 - 2. Type: Non-freeze.
 - 3. Materials
 - a. Body: Bronze.
 - b. Face: Polished bronze, nickel bronze, or brass.
 - c. Casing: Bronze or brass.
 - 4. Key: T-handle.
 - 5. Inlet: 3/4 inch IPS.
 - 6. Vacuum Breaker: Integral feature.

2.2 HOSE BIBBS

A. Hose Bibbs

1. Acceptable Manufacturer: Chicago, or T & S Brass.
2. Type: Exterior.
3. Finish: Polished chrome plated.
4. Outlet: 3/4 inch hose thread.
5. Inlet: 3/4 inch flanged female IPS.
6. Handle: Removable tee handle/shield cap.
7. Vacuum Breaker: Integral.

2.3 WATER HAMMER ARRESTERS

A. Water Hammer Arrester for Standard Plumbing Fixtures

1. Acceptable Manufacturer: J. R. Smith Hydrotrol, or Zurn, Wade, Watts, Josam.
2. Type: Bellows surrounded by hydraulic fluid and nitrogen or argon pressurized chamber or pre-pressurized tank with butyl diaphragm that separates air and water or free turning brass piston with O-ring seals that separates air and water.
3. Material: Stainless steel or steel tank with polypropylene liner surge chamber, or barrel fabricated of type K hard drawn copper.

2.4 THERMOSTATIC MIXING VALVE (TMV-1)

- A. Acceptable Manufacturer: Powers Hydroguard, or Symmons.
- B. Features: Hi/Lo single valve, tamper proof temperature adjustment control, union inlets, combination strainer-check-stops, built-in shutoff in the event of hot or cold water supply failure, or thermostatic element failure.
- C. Thermostatic mixing valve(s) shall be installed in accordance with manufacturer's piping installation diagram(s).

2.5 THERMOSTATIC MIXING VALVE (TMV-2 & 3) (EMERGENCY EYEWASH AND SHOWER)

- A. Acceptable Manufacturer: Bradley S19-2100 & S19-2200 or HAWS.
- B. Features: Tamperproof temperature adjustment control, union inlets, combination strainer-check-stops, built-in cold water bypass, built-in shut-off in the event of hot or cold water supply failure, or thermostatic element failure, and built-in dial thermometer.

- C. Components: Factory assembled thermostatic mixing valve, high temperature limit valve, bypass valve, and outlet temperature gage.
- D. Thermostatic mixing valve(s) shall be installed in accordance with manufacturer's piping installation diagram(s).

2.6 THERMOSTATIC MIXING VALVE (TMV-4 THRU TMV-7)

- A. Acceptable Manufacturer: Symmons or Powers.
- B. Features: Tamperproof temperature adjustment control, union inlets, combination strainer-check stops, built-in shutoff in the event of hot or cold water supply failure, or thermostatic element failure.
- C. Thermostatic mixing valve(s) shall be installed in accordance with manufacturer's piping installation diagram(s).

2.7 TEMPERATURE-PRESSURE RELIEF VALVE

- A. Acceptable Manufacturer: Watts.
- B. Construction: Bronze body. ASME rated, AGA certified. Non-mechanical seat-to-disc alignment.

2.8 VACUUM BREAKER

- A. Acceptable Manufacturer: Watts.
- B. Type: Anti-siphon with bronze body and internal trim, plane brass finish, with full size orifice.
- C. Working Pressure: 125 psi.

PART 3 - EXECUTION

3.1 INSTALLATION

- A. Install plumbing specialties in accordance with equipment manufacturer's recommendations. Submit manufacturer's printed installation instructions, operating and maintenance data, and wiring diagrams for all electric powered equipment at completion of Work.
- B. Connections to fixtures and equipment shall be according to manufacturer's recommendations. Piping runs shall be made in a manner to insure easy and even flow, eliminate air pockets, and to permit drainage and venting. Provide 6 inch (minimum) separation between hot and cold water piping.
- C. Mains and principle branches shall be valved for isolation and shall have drain valves installed at low points for system draining.

- D. Rough-in and make final connections to equipment furnished by Owner. Verify all locations for roughing-in with equipment supplier prior to start of Work.
- E. Furnish and install proper plastic-to-copper adapters for all plumbing fixture supplies.
- F. Domestic hot and cold water piping systems shall be disinfected prior to use. Method to be used shall be that method prescribed by local codes, or, if method is not prescribed by local code, the International Plumbing Code (latest edition) method should be followed. For plastic water piping systems verify with plastic pipe manufacturer that disinfection solution to be used will not harm piping system.
- G. Thermostatic mixing valves shall be installed in accordance with manufacturer's piping installation diagram(s) and referenced details.

3.2 TESTING AND BALANCING

- A. Water Lines: Test water lines in accordance with local codes. If method is not prescribed by local codes, the International Plumbing Code (latest edition) method shall be followed.
- B. Valves: Test valve bonnets for tightness. Test-operate valves at least one time from closed-to-open-to-closed positions while valve is under pressure. Test automatic valves for proper operation at settings indicated. Test pressure relief valves minimum of three times.
- C. Other Tests: Test all piping specialties for proper operation.

END OF SECTION

**SECTION 120060
PLUMBING VALVES**

PART 1 - GENERAL

1.1 WORK INCLUDED

- A. The Work of this Section shall consist of the labor, materials and equipment required for the installation of plumbing valves.

1.2 SUBMITTALS

- A. Submit for approval in accordance with specified submittal procedures:
 - 1. Valves

PART 2 - PRODUCTS

2.1 VALVES

- A. Furnish and install valves as specified herein and as scheduled in Part 3 - Execution, of this Section. Insofar as possible all valves shall be of a single manufacturer.
- B. Packings, gaskets, discs, seats, diaphragms, lubricants, etc., shall conform to recommendations of the valve manufacturer for the intended service.
- C. If space permits, install valves with stems horizontal or extending vertically upward unless specifically shown otherwise. Valves shall be installed in accessible locations for operation as well as for removal, repair, or replacement.
- D. Valves installed in Insulated Piping: With stem or neck extensions of sufficient length to accommodate insulation thickness and the following features:
 - 1. Ball Valves: With extended operating handle of non-thermal-conductive material, and protective sleeve that allows operation of valve without breaking the vapor seal or disturbing insulation.
- E. Provide Owner with one operating wrench for every ten (10) valves of each type (but not less than 2 wrenches) not equipped with handwheels or levers.
- F. Valves shall conform to the following schedules:

BALL VALVE SPECIFICATIONS

Type	Size	Press. psig	Description	Acceptable Manufacturer
BA-2	thru 2"	150S 400WOG	NSF/AWWA approved for potable water; Threaded ends; Bronze, two piece body; Manually operated; Chrome plated bronze ball; Teflon seats	Apollo Milwaukee Nibco
BA-5	2" thru 8"	200WC 200 degrees F.	NSF approved for potable water; Flanged ends; Epoxy coated A126 Class B iron body; Teflon-fused solid ball; Full port; 100 percent lead free	American Valve
BA-7	1/2" & 3/4"	5 psig	Threaded ends; Bronze body; Two piece body, full port chrome plated brass ball	Apollo CB-10 Nibco GB
BA-8	1" thru 2"	5 psig	Threaded ends; Bronze body; Full port chrome plated brass ball	Nibco T-FP600 Jomar JMT-100

CHECK VALVE SPECIFICATIONS

Type	Size	Press. psig	Description	Acceptable Manufacturer
CK-2	thru 2"	125S 200WOG	Soldered ends; Bronze body; Renewable bronze disc swing type	Crane Nibco Hammond Anvil International Milwaukee
CK-3	2-1/2" thru 12"	125S 200WOG	Flanged ends; Iron body; Bronze trim; Bronze disc swing type	Crane Nibco Hammond Anvil International Milwaukee

PLUG VALVE SPECIFICATIONS				
Type	Size	Press. psig	Description	Acceptable Manufacturer
PL-1	thru 2"	200WOG	Threaded ends; Cast iron body; Lubricated plug; Wrench operated	Walworth
PL-2	2-1/2" thru 10"	200WOG	Flanged ends; Cast iron body; Lubricated plug; 4" & under: wrench operated; over 4": worm gear operated	Walworth

PART 3 - EXECUTION

3.1 APPLICATION

- A. Valves shall be installed in accordance with the following valve schedule:

VALVE SCHEDULE			
Piping System	Valve Service		
	Shut-off	Balancing	Check
Domestic Water, Copper: Cold, Hot, Hot Recirc., Make-up	BA-2, BA-5	n/a	CK-2, CK-3
Propane Gas	BA-7, BA-8, PL-1, PL-2	n/a	n/a
Compressed Air	BA-2	n/a	n/a

3.2 INSTALLATION

- A. Contractor shall carefully follow the Drawings in laying out and installing his work and he shall not deviate therefrom, except for structural or interior finish interferences.
- B. All valves shall be carefully inspected for defects in workmanship prior to installation. Any item found unsuitable, cracked, or otherwise defective shall be rejected and removed from the job site. All valves shall have factory applied markings, stampings, or nameplates with sufficient data for identification to determine their conformance with specified requirements.

- C. Provide flanges or unions at all final connections to valves to facilitate dismantling.
- D. Unless otherwise indicated, install all shutoff valves to pumps and other equipment at line size with reduction in size being made only at inlet to pump or other equipment.

****END OF SECTION****

**SECTION 120070
PLUMBING SUPPORTS AND ANCHORS**

PART 1 - GENERAL

1.1 WORK INCLUDED

- A. The Work of this Section shall consist of the labor, materials and equipment required for the installation of plumbing supporting devices.

PART 2 - PRODUCTS

2.1 HANGERS – INSULATED PIPING

- A. Acceptable Manufacturer: Anvil International, or Penn Pipe Hanger.
- B. Hangers used with insulated piping shall be sized to accommodate the pipe, and insulation and shall have a support shield to prevent the hanger from compressing the insulation. Hanger shall be clevis type with rod and two nuts or bolt and nut.

2.2 HANGERS – UNINSULATED PIPING

- A. Acceptable Manufacturer: Anvil International, or Penn Pipe Hanger.
- B. Hangers for uninsulated ferrous pipe shall be clevis type with rod and two nuts or bolt and nut. Hangers for uninsulated copper pipe shall be clevis type with bolt and nut and shall be copper plated.

2.3 INSERTS – POURED CONCRETE

- A. Acceptable Manufacturer: Anvil International, or Penn Pipe Hanger.
- B. Inserts shall have cast malleable iron body and nut with galvanized finish.

2.4 INSERTS – PRECAST OR CURED CONCRETE

- A. Acceptable Manufacturer: Hilti HSL.
- B. A high integrity, torque controlled anchor for heavy duty fastenings. Loads shall not exceed manufacturer's recommended weight.

2.5 BEAM CLAMPS

- A. For pipe sizes of 3 inches and smaller:

1. Acceptable Manufacturer: Anvil International, or Penn Pipe Hanger.
2. Clamps for attachment to I beams and/or steel joists shall be malleable iron C clamp with hardened steel cup and point set screw and locknut.

B. For pipe sizes of 4 inches and larger:

1. Acceptable Manufacturer: Anvil International.
2. Clamps for attachment to I beams and/or steel joists shall be adjustable type with malleable iron jaw, steel tie rod, nuts, and washer.

2.6 PIPE RISER CLAMPS

A. Acceptable Manufacturer: Anvil International, or Penn Pipe Hanger.

B. Pipe riser clamps for both insulated and uninsulated vertical pipe risers shall be 2 piece clamp complete with 2 bolts and 2 nuts, sized for the outside diameter of the bare pipe to be supported. Clamp shall be carbon steel construction with galvanized finish for ferrous pipe and copper plated for copper pipe.

PART 3 - EXECUTION

3.1 INSTALLATION

- A. The requirements of the applicable Sections of ANSI B31, Pressure Piping shall be considered as minimum requirements governing fabrication, installation, and support of piping systems except where more specific or stringent requirements are stated herein.
- B. All piping and piping connected equipment, including valves, traps, and other specialties and accessories shall be supported in a manner that will not result in excessive stress, deflection, swaying, sagging or vibration in the piping or in the building structure either during erection, cleaning, testing, or normal operation of the systems. Piping shall not be so restrained, however, as to cause it to snake or buckle between supports or anchors, or to prevent proper movement due to expansion and contraction. Piping shall be supported at equipment and valves such that they can be disconnected and removed without further supporting the piping. Piping shall not introduce any strains or distortion to the connected equipment.
- C. Hangers, riser clamps, and supports shall be installed complete, including locknuts, clamps, rods, bolts, couplings, swivels, inserts, and required accessory items. Hangers for horizontal piping shall have adequate means of vertical adjustment for proper alignment of pipe, and shall be provided with locknuts. All hangers, riser clamps, and supports in direct contact with copper piping shall be copper plated or plastic coated.
- D. Maximum spacing of supports for horizontal piping, except plastic piping, shall be as listed below. Provide hanger rods in diameters recommended by hanger manufacturer.

<u>Pipe Size</u>	<u>Uninsulated Steel</u>	<u>Insulated Steel</u>	<u>Copper Tubing</u>	<u>Cast Iron</u>
1/2"	7'	7'	5'	-
3/4"	7'	7'	5'	-
1"	7'	7'	5'	-
1-1/4"	7'	7'	6'	-
1-1/2"	9'	9'	8'	-
2"	10'	10'	8'	5'
2-1/2"	11'	10'	9'	5'
3"	12'	10'	10'	5'
4"	12'	10'	10'	5'
5"	12'	10'	10'	5'
6"	12'	10'	10'	5'
8"	12'	10'	10'	5'

- E. Maximum spacing of supports for horizontal plastic sanitary drainage and vent piping shall be as listed below. Provide hanger rods in diameters recommended by hanger manufacturer.

<u>Pipe Size</u>	<u>Sanitary Drainage</u>	<u>Sanitary Vent</u>
1-1/2"	3'	4'
2"	3'	4'
3"	3-1/2'	4'
4"	4'	4'
6"	4'	4'
8"	4'	4'
10"	4'	4'

- F. Maximum spacing of supports for horizontal plastic rainwater conductors shall be as listed below. Provide hanger rods in diameters recommended by hanger manufacturer.

<u>Pipe Size</u>	<u>Storm Drainage</u>
2"	4'
4"	4'
6"	4'
8"	4'
10"	4'

- G. Provide additional supports where pipe changes direction, adjacent to flanged valves and at equipment connections and heavy fittings. Provide at least one hanger adjacent to each joint in cast iron soil pipe and grooved end steel pipe with mechanical couplings. Support vertical pipe with riser clamps installed below hubs, couplings or lugs welded to the pipe.
- H. Refer to Section 12, Special Piping Systems for maximum spacing of supports for acid waste piping.

- I. Inserts for supports in precast concrete slabs shall be drilled with rotary electric drill.
- J. Lag screws shall be used to attach hangers to wood construction.
- K. Beam clamps shall be used to attach hanger rods to structural steel.

****END OF SECTION****

**SECTION 120080
PLUMBING INSULATION**

PART 1 - GENERAL

1.1 WORK INCLUDED

- A. The Work of this Section shall consist of the labor, materials and equipment required for insulating plumbing piping and equipment.

1.2 SUBMITTALS

- A. Submit for approval in accordance with specified submittal procedures:
 - 1. Insulation Materials, including application thicknesses
 - 2. Sealants, Adhesives, Coatings

PART 2 - PRODUCTS

2.1 FIBERGLASS PIPE INSULATION SPECIFICATION NO. 1

- A. Acceptable Manufacturer: Johns Manville Micro Lok AP T Plus, or Owens Corning Fiberglas SSL II/ASJ.
- B. Material: Fiberglass pipe insulation with all purpose vapor barrier jacket for indoor installations.
- C. Properties
 - 1. Maximum K Factor: 0.23 at 75 degrees F. mean.
 - 2. Temperature Range: 0 degrees F. to 850 degrees F.
 - 3. Fire Hazard: FHC 25/50 per ASTM E 84 and UL 723.
 - 4. For use on pipe sizes 1/2 inch to 12 inches
- D. Seams and Joints: Self-sealing (pressure sensitive) lap seams and matching butt strips.
- E. Fittings
 - 1. Fiberglass batt inserts with premolded PVC jacket:
 - a. Acceptable Manufacturer: Johns Manville Zeston 2000 PVC, or Foster Speed Line, Proto.
 - b. Properties: 0.28 max. K at 75 degrees F. mean, 0 degrees F. to 450 degrees F. temperature range, FHC 25/50 fire hazard per ASTM E 84.
 - 2. Fitting insulation shall be same thickness as adjacent insulation.

2.2 FLEXIBLE ELASTOMERIC PIPE INSULATION SPECIFICATION NO. 2

- A. Acceptable Manufacturer: Armacell AP Armaflex w/520 BLV Adhesive, or Rubatex.
- B. Material: Flexible elastomeric thermal pipe insulation, black in color.
- C. Properties
 - 1. Maximum K Factor: 0.27 at 75 degrees F.
 - 2. Compliance: ASTM E84, 25 flame/50 smoke.
 - 3. Temperature Range: Minus 70 degrees F. to 220 degrees F.
 - 4. For use on pipe sizes: 3/8 inch to 6 inch.
- D. Fittings, Joints: Mitered cut, same thickness as adjacent insulation.
- E. Adhesive: Toluene free, low VOC.

2.3 FLEXIBLE ELASTOMERIC SHEET/ROLL INSULATION SPECIFICATION NO. 4

- A. Acceptable Manufacturer: Armacell AP Armaflex w/520 Adhesive, or Rubatex.
- B. Material: Exterior flexible elastomeric thermal sheet or roll insulation.
- C. Properties
 - 1. Maximum K Factor: 0.27 at 75 degrees F. mean.
 - 2. Compliance: ASTM E84, 25 flame/50 smoke.
 - 3. Temperature Rating: Minus 70 degrees F. to 220 degrees F.

PART 3 - EXECUTION

3.1 APPLICATION

- A. Insulation shall be installed in accordance with the following insulation schedule(s). (Where more than one insulation type is scheduled, Contractor shall have the option of choosing from types listed.)

PIPE INSULATION SCHEDULE

Service	Temp. Range Deg. F	Insul. Spec. No.	Minimum Pipe Insulation Thickness				
			Runouts		Mains		
			to 2"	to 1"	1-1/4" to 2"	2-1/2" to 4"	5" & larger
Dom Cold Water	30-60	1	1/2	1/2	1/2	1/2	1/2
		2	1/2	1/2	1/2	1/2	1/2

PIPE INSULATION SCHEDULE

Service	Temp. Range Deg. F	Insul. Spec. No.	Minimum Pipe Insulation Thickness				
			Runouts		Mains		
			to 2"	to 1"	1-1/4" to 2"	2-1/2" to 4"	5" & larger
Dom. Hot Water	100-139	1	1	1	1	1	1
	140-169	2	1	1	1	1-1/2	1-1/2
		2	1	1	1	1-1/2	1-1/2
Dom. Hot Water	100-139	1	1	1	1	1	1
		2	1	1	1	1	1
Recirculating Dom Make-up Water	50-65	1	1/2	1/2	1/2	1/2	1/2
		2	1/2	1/2	1/2	1/2	1/2
Horiz. Rain Water	---	1	N/A	N/A	N/A	1/2	1/2
		2	N/A	N/A	N/A	1/2	1/2

EQUIPMENT INSULATION SCHEDULE

Equipment	Insulation Spec. No.	Thickness, Inches
Roof Drain Body	4	1/2

3.2 INSTALLATION

A. General

1. Surface areas of all pipe to be insulated shall be clean and dry. Insulation shall not be installed until all tests and inspections of the specific system(s) are complete.
2. All pipe insulation shall be continuous through wall and ceiling/floor penetrations except where specific sealing requirements are specified, i.e. fire rated separations.
3. Insulate all components in piping systems, including valve bodies, hangers, guides, anchors, and pump housings. Do not insulate expansion compensators in hot water systems. Maintain access to all servicing points and nameplate data.
4. Insulation on all cold surfaces shall provide a continuous unbroken vapor seal.
5. Provide shields at all pipe hangers where protection saddles are not installed on pipes. Shields shall be galvanized sheet metal, formed to fit insulated pipe outside diameter, and shall extend up to the pipe centerline. Shield lengths shall be as follows:

Pipe Sizes, Inches	Shield Length, Inches
1-1/2 to 2-1/2	10
3 to 6	12

Pipe Sizes, Inches	Shield Length, Inches
8 to 10	16
12 and over	22

6. Insulation installed on plastic piping shall be installed with provisions for pipe expansion, without effect on insulation.
7. Adhesives, mastics, sealers, and coatings shall be applied at manufacturer's required ambient conditions and recommended minimum coverage.

B. Fiberglass Pipe Insulation

1. All piping shall be cleaned of debris prior to installation of insulation and components. Joints shall be butted firmly together. Longitudinal laps and butt strips shall be securely fastened as recommended by the manufacturer.
2. Fittings, insulated with fiberglass blanket and PVC jacket shall be installed in accordance with insulation manufacturer's instructions. All butt joints between longitudinal pipe insulation and fittings shall be taped.

C. Flexible Elastomeric Thermal Pipe and Sheet Insulation

1. Insulation shall be installed neatly with oversized pipe insulation and sheet insulation being used for fittings and valves. For outdoor installations, completely wrap insulation surface with glass fiber mesh and fully adhere/lag glass mesh to insulation with one coat of insulation adhesive. Inspect for bonding of glass mesh to insulation surfaces before applying specified weatherproof finish. Consult insulation manufacturer's recommendations for coatings and sealants.

END OF SECTION

**SECTION 120110
PLUMBING PUMPS**

PART 1 - GENERAL

1.1 WORK INCLUDED

- A. The Work of this Section shall consist of the labor, materials and equipment required for the installation of plumbing pumps.

1.2 RELATED SECTIONS

- A. Section 12, Plumbing Basic Materials: Equipment nameplates and motors.
- B. Section 1, Building Automation System: Controls.

1.3 SUBMITTALS

- A. Submit for approval in accordance with specified submittal procedures:
 - 1. Pumps

PART 2 - PRODUCTS

2.1 INLINE CIRCULATOR PUMP

- A. Acceptable Manufacturer: Bell & Gossett, or Taco, Armstrong.
- B. Pump and Motor Assembly: Hermetically sealed with motor and impeller on common shaft and designed for installation with pump and motor shaft horizontal.
- C. Casing: Bronze, with threaded or companion-flange connections, rated for a minimum of 150 psi working pressure, equipped with gage parts and suitable for operation at 225 degrees F.
- D. Impeller: Plastic.
- E. Motor: Single speed, unless otherwise indicated. Refer to Section 12, Plumbing Basic Materials.

PART 3 - EXECUTION

3.1 INSTALLATION

- A. Inline pumps shall be installed with valves, and gages as detailed on the Drawings. Provide flanges or unions at all pump connections to facilitate dismantling.

- B. Diagrammatic representation of inline pumps on the Drawings is only for clarification of pump location. Actual positioning of pump in the piping system, orientation of pump and motor, and location of supports for pumps shall be in accordance with pump manufacturer's recommendations.
- C. Contractor shall carefully follow the Drawings in laying out and installing his work and he shall not deviate therefrom, except for structural or interior finish interferences.
- D. All pumps and accessories shall be carefully inspected for defects in workmanship prior to installation. Any item found unsuitable, cracked, or otherwise defective shall be rejected and removed from the jobsite. All pumps shall have factory applied markings, stampings, or nameplates with sufficient data for identification to determine their conformance with specified requirements.
- E. During construction all openings in pumps shall be kept closed except when actual work is being performed on that item. Closures shall be plugs, caps, blind flanges, or other items specifically intended for this purpose. Exercise all necessary care to prevent foreign objects from entering material.

END OF SECTION

**SECTION 120120
SANITARY DRAINAGE**

PART 1 - GENERAL

1.1 WORK INCLUDED

- A. The Work of this Section shall consist of the labor, materials and equipment required for installation of the sanitary drainage system.
- B. Sanitary drainage shall be collected as indicated and connected to site sanitary lateral(s) at 5'-0" outside building.

1.2 SUBMITTALS

- A. Submit for approval in accordance with specified submittal procedures:
 - 1. Cleanouts
 - 2. Floor Drains
 - 3. Drain Traps
 - 4. Trap Guard Device
 - 5. Safe Pans
 - 6. Trench Drains and Covers
 - 7. Funnels
- B. Submit written verification of testing procedures specified herein.

PART 2 - PRODUCTS

2.1 CLEANOUTS

- A. Wall Cleanouts
 - 1. Acceptable Manufacturer: J.R. Smith Fig. 4422, or Zurn, Watts, Wade, Josam.
 - 2. Size: Cleanouts shall be full size of pipe to 4 inch and not less than 4 inch for larger pipe sizes.
 - 3. Plug: Bronze with tapered threads or with lead seal.
 - 4. Cover: Stainless steel shallow cover secured to plug with vandalproof screws.
- B. Exterior Cleanouts
 - 1. Acceptable Manufacturer: J.R. Smith Fig. 4251 U, or Zurn, Watts, Wade, Josam.

2. Size: Cleanouts shall consist of wye fitting, full size of pipe to 4 inch and not less than 4 inch for larger pipe sizes.
3. Plug: Bronze, countersunk, rectangular slotted, with emulsified lead paste.
4. Cover: Cast iron, non-skid, vandalproof, gasketed, watertight secured independently of plug.
5. Anchoring: 6 inch of concrete shall be poured around wye fitting, cleanout pipe and cleanout cover frame. Concrete shall terminate 6 inch below grade.

C. Floor Cleanouts, For Finished Floors

1. Acceptable Manufacturer: J.R. Smith Fig. 4021, or Zurn, Watts, Wade, Josam.
2. Size: Cleanouts shall consist of wye fitting, full size of pipe to 4 inch and not less than 4 inch for larger pipe sizes.
3. Plug: Bronze, countersunk, rectangular slotted, with emulsified lead paste and spigot outlet.
4. Cover: Scoriated nickel bronze top.

2.2 FLOOR DRAINS

A. Floor Drain FD-1

1. Acceptable Manufacturer: J.R. Smith Fig. 2010, or Zurn, Watts, Wade, Josam.
2. Body: Cast iron.
3. Outlet: Bottom.
4. Flashing Ring: Provided with weepholes.
5. Strainer: Adjustable, square with vandalproof screws. Nickel bronze or nickel brass.
6. Furnish with trap guard device.

B. Floor Drain FD-2

1. Acceptable Manufacturer: J.R. Smith Fig. 2120, or Zurn, Watts, Wade, Josam.
2. Body: Cast iron.
3. Outlet: Bottom.
4. Flashing Ring: Provided with weepholes.
5. Grate: Cast iron tractor grate, vandalproof.
6. Furnish with trap guard device.

2.3 DRAIN TRAPS

- A. Acceptable Manufacturer: J.R. Smith Fig. 7222, or Zurn, Watts, Josam.
- B. Where drains are specified without integral trap, furnish and install deep seal P trap of cast iron construction with hub inlet, spigot outlet.

2.4 TRAP GUARD DEVICE

- A. Acceptable Manufacturer: Proset Trap Guard, or J.R. Smith Quad Close, Sure Seal Trap Sealer
- B. Type: Barrier type trap seal protection device, inline floor drain trap sealer, elastomeric, neoprene rubber. Prevents the evaporation of the trap seal and the emission of sewer gases.
- C. Approvals: ASSE 1072-2007.

2.5 SAFE PANS

- A. Acceptable Manufacturer: Noble Company Chloraloy.
- B. Provide safe pans (sub pans) for all floor drains in floor slabs not installed on grade. Safe pans shall be constructed of chlorinated polyethylene concealed waterproof membrane, 0.040 inch thick (nominal), weldable with chlorinated polyethylene solvent bonding liquid or Xylene.
- C. Size: 36 inches square.

2.6 TRENCH DRAIN AND COVER (TD-1)

- A. Acceptable Manufacturer: J.R. Smith 9818.
- B. Material: Precast polymer concrete with integral metal rail edge construction, extra heavy duty.
- C. Frame: Sloped, furnished in 39 inch (1 meter) lengths.
- D. Cover: Furnished in 39 inch (1 meter) lengths, load class E, J. R. Smith 9870-461-M.

2.7 TRENCH DRAIN AND COVER (TD-2)

- A. Acceptable Manufacturer: J.R. Smith 2885-NB.
- B. Material: Cast iron construction, frame and nickel bronze cover, light duty.
- C. Frame: Furnish in 12 inch lengths.
- D. Cover: Furnished in 12 inch lengths, vandalproof.

2.8 FUNNELS

- A. Acceptable Manufacturer: J.R. Smith Fig. 3812, or Zurn, Watts, Wade, Josam.
- B. Body: Cast iron.
- C. Outlet: No hub or caulked.

PART 3 - EXECUTION

3.1 INSTALLATION

- A. Drainage lines shall be properly vented, graded and trapped to conform to local and state requirements.
- B. Each fixture shall be vented and trapped. Each vent shall be extended through roof, or shall be loop vented into a common main, acceptable by code. Where a vertical vent riser connects to another vent riser, an inverted wye fitting shall be provided.
- C. Cleanouts shall be provided in soil and waste piping where shown, at the ends of all mains, at intersection of branches with mains, at base of vertical stacks, at intermediate points of long runs not exceeding 40 feet, and at additional locations required by local ordinances.
- D. Rough in and make final connections to equipment furnished by Owner. Verify locations for roughing in with equipment supplier prior to start of work.
- E. Unless indicated otherwise, horizontal sanitary and waste lines 2-1/2 inches and smaller shall be graded 1/4 inch per foot inside building. Horizontal sanitary and waste line 3 inches and larger shall be graded 1/8 inch per foot and in accordance with inverts indicated outside building.
- F. Floor drains and piping floor penetrations shall be sealed to prevent leakage to floor below.
- G. Sanitary and vent piping below floor on grade shall be minimum 2 inches inside diameter, no-hub.
- H. No-hub fittings shall have a pipe stop on the interior of the fitting as well as a stainless steel shield that surrounds the coupling material. Dual pipe clamps shall be installed around the shield.
- I. No-hub cast iron fittings shall be supported by clevis hangers. Wire, string, or strapping supports will not be permitted.
- J. Vertical sanitary and vent piping shall be supported at each floor with riser clamps. Pipe joints shall not occur at floor line.

3.2 PURGING AND TESTING

- A. Sanitary Piping, Gravity
 1. Water Test: The water test shall be applied to the drainage system either in its entirety or in sections after rough piping has been installed. If testing entire system, all openings in the piping shall be closed tightly, except for the highest opening in the system. The system shall be filled with water to point of overflow. If system is tested in sections, each opening shall be plugged tightly except for the highest opening in the section under test. Each section shall then be filled with water. A section shall not be tested with less than a 10 foot head of water. In testing successive sections, at least the upper 10 feet of the next preceding section shall be tested so that a joint or pipe in the building (except the uppermost 10 feet of the system) shall not have been submitted to a test of less than a 10

foot head of water. Test water shall be kept in the system, or in the portion under test for 1 hour before start of inspection. The system shall remain tight at all points throughout inspection. If any leaks occur, those areas shall be corrected and re tested.

2. Drainage and Vent Air Test: An air test shall be made by forcing air into the system until there is a uniform gauge pressure of 5 pounds per square inch (psi) (34.5 kPa) or sufficient to balance a 10 inch (254 mm) column of mercury. This pressure shall be held for a test period of at least 15 minutes. Any adjustments to the test pressure required because of changes in ambient temperature of the seating of gaskets shall be made prior to the beginning of the test period. If any leaks occur those areas shall be corrected and retested.

****END OF SECTION****

SECTION 120130 INTERCEPTORS

PART 1 - GENERAL

1.1 WORK INCLUDED

- A. The Work of this Section shall consist of the labor, materials and equipment required for installation of the sanitary system interceptors.

1.2 SUBMITTALS

- A. Submit for approval in accordance with specified submittal procedures:
 - 1. Interceptors

PART 2 - PRODUCTS

2.1 OIL/SEDIMENT INTERCEPTOR

- A. Acceptable Manufacturer: Highland Tank Model SB 051-750.
- B. Body: Constructed of high-strength, mild carbon steel, meeting ASTM specifications, with capacities, dimensions, construction, and thickness in strict accordance with Underwriters Laboratories, Subject UL-58 Standard for Safety, Steel Underground Tanks for Flammable and Combustible Liquids, September 30, 1997, Single Wall construction.
- C. Corrosion Control System: Shall be in strict accordance with Underwriters Laboratories Inc. Subject UL-1746 Standard for External Corrosion Protection Systems for Steel Underground Storage Tanks.
- D. Interceptor shall be fabricated, inspected and pressure tested for leakage before shipment from the factory by manufacturer as a completely assembled, single vessel ready for installation.
- E. Interceptor shall be cylindrical, horizontal, atmospheric-type steel vessel.
- F. Interceptor shall consist of inlet and outlet connections, internal influent nozzle, heavy duty sludge baffle, large sediment and oil pump-out access, effluent downcomer, fittings for vent, sampling, gauging, and lifting lugs.

PART 3 - EXECUTION

3.1 INSTALLATION

- A. Install interceptors and complete piping connections in accordance with equipment manufacturer's recommendations. Submit manufacturer's printed installation instructions with operating and maintenance data at completion of Work.

****END OF SECTION****

SECTION 120140 STORM DRAINAGE

PART 1 - GENERAL

1.1 WORK INCLUDED

- A. The Work of this Section shall consist of the labor, materials and equipment required for installation of the storm water drainage system.
- B. Storm water drainage systems shall be connected to the site drainage system 5'-0" from building.

1.2 SUBMITTALS

- A. Submit for approval in accordance with specified submittal procedures:
 - 1. Cleanouts
 - 2. Roof Drains
 - 3. Overflow Drains
 - 4. Downspout Nozzles
- B. Submit written verification of testing procedures specified herein.

PART 2 - PRODUCTS

2.1 CLEANOUTS

- A. Wall Cleanouts
 - 1. Acceptable Manufacturer: J.R. Smith, or Zurn, Watts, Wade, Josam.
 - 2. Size: Cleanouts shall be full size of pipe to 4 inches pipe size and not less than 4 inches for larger pipe sizes.
 - 3. Plug: Bronze, countersunk, rectangular slotted, with emulsified lead paste.
 - 4. Cover: Chrome plated bronze face of wall cover secured to plug with vandalproof screws.
- B. Exterior Cleanouts
 - 1. Acceptable Manufacturer: J.R. Smith, or Zurn, Watts, Wade, Josam, Jones Manufacturing.
 - 2. Size: Cleanouts shall consist of wye fitting full size of pipe to 4 inches pipe size and not less than 4 inches for larger pipe sizes.
 - 3. Plug: Bronze, countersunk, rectangular slotted with emulsified lead paste.

4. Cover: Cast iron, non-skid, vandalproof, gasketed, watertight secured independently of plug.
5. Anchoring: 6 inches of concrete shall be poured around wye fitting, cleanout pipe, and cleanout cover frame. Concrete shall terminate 6 inches below grade.

C. Floor Cleanouts, For Finished Floors

1. Acceptable Manufacturer: J.R. Smith Fig. 4021, or Zurn, Watts, Wade, Josam.
2. Size: Cleanouts shall consist of wye fitting, full size of pipe to 4 inch and not less than 4 inch for larger pipe sizes.
3. Plug: Bronze, countersunk, rectangular slotted, with emulsified lead paste and spigot outlet.
4. Cover: Scoriated nickel bronze top.

2.2 ROOF DRAINS

A. Roof Drain RD-1

1. Acceptable Manufacturer: J.R. Smith, or Zurn, Watts, Wade, Josam.
2. Type: For installation in insulated precast concrete or insulated metal roof decks where insulation is sloped to roof deck providing a sump for roof drain.
3. Materials
 - a. Body: Cast iron.
 - b. Dome: Cast iron, rough bronze, aluminum or brass.
4. Body: Provide flashing collar and gravel stop, sump receiver and under deck clamp.
5. Dome: Lock type.
6. Outlet: Bottom, inside calk.

2.3 OVERFLOW DRAINS

A. Overflow Drain OFD-1

1. Acceptable Manufacturer: J.R. Smith, or Zurn, Watts, Wade, Josam.
2. Type: For installation in insulated precast concrete or insulated metal roof decks.
3. Materials
 - a. Body: Cast iron.
 - b. Dome: Cast iron, rough bronze, aluminum or brass.
4. Body: Provide flashing collar and gravel stop, extension flange, sump receiver, and under-deck clamp.
5. Dome: Lock type.
6. Outlet: Bottom inside calk.
7. Standpipe: Cut PVC standpipe to achieve ponding depth at base of drain.

2.4 DOWNSPOUT NOZZLES

A. Downspout Nozzle OFDN-1

1. Acceptable Manufacturer: J.R. Smith 1770 or Zurn, Wade, Josam.
2. Material: Cast bronze body and flange.
3. Screen: Stainless steel.

PART 3 - EXECUTION

3.1 INSTALLATION

- A. Horizontal rain water conductors and storm sewers within the building shall be graded 1/8 inch per foot or in accordance with inverts indicated on Drawings. Horizontal storm lines outside building shall be graded.
- B. Cleanouts shall be provided in storm piping, at ends of all mains, at intersection of branches with mains, at base of vertical stacks, at intermediate points of long runs not exceeding 40 feet, and at other points required by local ordinances.

3.2 PURGING AND TESTING

A. Storm Piping, Gravity (Either of the following testing methods may be used.)

1. Water Test: The water test shall be applied to the drainage system either in its entirety or in sections after rough piping has been installed. If testing entire system, all openings in the piping shall be closed tightly, except for the highest opening in the system. The system shall be filled with water to point of overflow. If system is tested in sections, each opening shall be plugged tightly, except for the highest opening of the section under test. Each section shall then be filled with water. A section shall not be tested with less than a 10 foot head of water. In testing successive sections, at least the upper 10 feet of the next preceding section shall be tested so that a joint or pipe in the building (except the uppermost 10 feet of the system) shall not have been submitted to a test of less than a 10 foot head of water. Test water shall be kept in the system, or in the portion under test, for 1 hour before start of inspection. The system shall remain tight at all points throughout inspection. If any leaks occur, those areas shall be corrected and re tested.
2. Drainage and vent air test. An air test shall be made by forcing air into the system until there is a uniform gauge pressure of 5 pounds per square inch (psi) (34.5 kPa) or sufficient to balance a 10 inch (254 mm) column of mercury. This pressure shall be held for a test period of at least 15 minutes. Any adjustments to the test pressure required because of changes in ambient temperature of the seating of gaskets shall be made prior to the beginning of the test period. If any leaks occur those areas shall be corrected and retested.

END OF SECTION

**SECTION 120150
WATER CONDITIONING SYSTEM**

PART 1 - GENERAL

1.1 WORK INCLUDED

- A. The Work of this Section shall consist of the labor, materials and equipment required for installation of the domestic water conditioning system.

1.2 SUBMITTALS

- A. Submit for approval in accordance with specified submittal procedures:
 - 1. Water Softener
 - 2. Brine Injection System

PART 2 - PRODUCTS

2.1 WATER SOFTENER B AUTOMATIC TWIN PROGRESSIVE SYSTEM

- A. Acceptable Manufacturer: Marlo MR-300-2.5-TW –PROG or Aqua Treatment Service, Culligan.
- B. Softener Tanks: Carbon steel resin tank shall be internally lined with an epoxy coating and shall have a corrosion resistant exterior. Tank shall have a 100 psi working pressure, hydrostatically tested to 100 psi, and a temperature rating of 35 degrees F – 110 degrees F. Tank shall bear ASME label.
- C. Brine System: Brine tank shall be molded rigid polyethylene with a tight fitting cover. Shall include an automatic air check assembly to prevent drawing air into the system, and a safety float shut-off valve to prevent overfilling of the brine tank.
- D. Resin: Shall be of premium quality, strong acid, sodium form caution exchange. Each cubic foot of resin shall be capable of removing 30,000 grains of hardness as calcium carbonate when generated with 15 lbs. of salt.
- E. Automatic Controls: An automatic brass body control valve shall provide adjustable timing [for delayed regeneration] and the intervals for all steps associated with the regeneration cycle (backwash, brine draw, slow rinse, fast rinse, and brine refill).
 - 1. The alternating twin system shall allow for one tank to be in regeneration or standby while the other tank is in service.
- F. Internal Distribution: Softener tanks shall be equipped with a lateral distributor system consisting of a slotted PVC design. The distributor shall be covered with a gravel support bed.

- G. Pipes, Valves, and Fittings: Pipes shall be standard weight, galvanized mild steel. Fittings shall be 125 psi class, galvanized malleable iron.
- H. Pressure Relief Valve: Furnish and install a pressure relief valve in the discharge piping of the pressure vessel(s).
- I. Water Testing Equipment: Complete water testing kit shall be furnished for conducting soap test.
- J. Instructions: Manufacturer's printed instructions covering installation and operation data shall be delivered to Owner. Start-up and test of equipment shall be conducted by factory trained personnel.
- K. Warranty: Water Softener shall have a 1-year limited warranty against defects in materials, workmanship, and corrosion. In addition, the tank shall have a 5-year warranty against internal corrosion.

2.2 BRINE INJECTION SYSTEM BI-1

- A. Acceptable Manufacturer: Cope Company Salt.
- B. Tank:
 - 1. Material: Polyethylene.
 - 2. Dimensions: 135 inches long x 55 inches wide x 70 inches high.
 - 3. Capacity: 14,000 lbs. of salt and 247.5 gallons of salt brine.
 - 4. Performance: With a 55 degree F water temperature, system shall produce 41.25 gallons of 100 percent saturated brine every 15.5 minutes.
- C. Pump:
 - 1. Type: Salt suitable submersible pump. Installed inside the tank.
 - 2. Motor: 1/2 HP, 230V/1PH/60Hz.
 - 3. Performance: 10 GPM at 20 feet ahead.
- D. Pipe: 3/4 inch continuous roll plastic pipe.

PART 3 - EXECUTION

3.1 INSTALLATION

- A. Install water conditioning equipment in accordance with equipment manufacturer's recommendations. Submit manufacturer's printed installation instructions with operating and maintenance data at completion of Work.

END OF SECTION

**SECTION 120160
WATER HEATERS**

PART 1 - GENERAL

1.1 WORK INCLUDED

- A. The Work of this Section shall consist of the labor, materials and equipment required for installation of the domestic water heating equipment.

1.2 SUBMITTALS

- A. Submit for approval in accordance with specified submittal procedures:
 - 1. Water Heaters
 - 2. Expansion Tanks

PART 2 - PRODUCTS

2.1 DOMESTIC WATER STORAGE HEATER, GAS COMMERCIAL, HIGH EFFICIENCY

- A. Acceptable Manufacturer: A. O. Smith BTH, or Bradford White E-Force.
- B. Heater Style: Standard vertical, AGA approved, condensing, ASME labeled and National Board number.
- C. Materials
 - 1. Tank: Welded steel.
 - 2. Tank Lining: Porcelain enamel (glass lined).
 - 3. Tank Jacket: Steel with baked enamel finish.
 - 4. Insulation: Blanket type glass fiber or polyurethane foam.
 - 5. Water Connections: Brass or bronze.
 - 6. Base and Legs: Steel or cast iron.
- D. Working Pressure: 150 psi.
- E. Fuel: Propane.
- F. Controls: Electronic control of ignition and temperatures up to 180• F.
- G. Venting: PVC, ABS, or CPVC pipe. Venting options shall include horizontal, vertical, and direct vent sealed combustion.

- H. Venting Accessories: Wall/roof termination kit with exhaust and intake terminals, roof/wall penetration accessories.
- I. Gas Pressure Regulator: Integral to heater.
- J. Temperature-Pressure Relief Valve: 3/4 inch, minimum, ASME.
- K. Manufacturer's Guarantee: 3 years.
- L. Compliance: ASHRAE/IESNA 90.1.

2.2 EXPANSION TANK

- A. Acceptable Manufacturer: Amtrol Series ST-C.
- B. Type: Diaphragm, vertical.
- C. Tank: Steel, bearing ASME label for unfired pressure vessels.
- D. Tank Lining: Polypropylene.
- E. Diaphragm: Custom molded butyl.
- F. Air Charge: Factory charged. Provide air charging valve on tank for field charging.

PART 3 - EXECUTION

3.1 INSTALLATION

- A. Install water heating equipment in accordance with equipment manufacturer's recommendations. Submit manufacturer's printed installation instructions with operating and maintenance data at completion of Work.

****END OF SECTION****

**SECTION 120170
PLUMBING FIXTURES**

PART 1 - GENERAL

1.1 WORK INCLUDED

- A. The Work of this Section shall consist of the labor, materials and equipment required for installation of plumbing fixtures and associated fittings and trim.

1.2 SUBMITTALS

- A. Submit for approval in accordance with specified submittal procedures:
1. Water Closets
 2. Lavatories
 3. Sinks
 4. Mop Receptors
 5. Showers
 6. Shower Fittings
 7. Electric Water Coolers
 8. Emergency Shower/Eyewashes
- B. Substitute manufacturer's fixtures shall be similar in style, dimensions and quality to the basis of design manufacturer's specified model number.

PART 2 - PRODUCTS

2.1 MATERIALS

- A. Fixtures shall be of one manufacturer, insofar as possible, and of first quality. Wall hung vitreous china fixture backings shall be drilled and tapped for mounting carriers specified.

2.2 WATER CLOSETS

- A. Water Closet WC-1
1. Acceptable Manufacturer: American Standard 2257.103, or Kohler, Sloan.
 2. Type: ADA compliant, wall hung, flush valve type, 1.6 gallon per flush, vitreous china, siphon jet action, elongated bowl, 1-1/2 inch top spud, 18 inch high, floor to rim.
 3. Seat:
 - a. Acceptable Manufacturer: Kohler, or Beneke, Olsonite. Bemis.

- b. Extra heavy, elongated, white, open front, check hinge.
- 4. Battery Powered Flush Valve:
 - a. Acceptable Manufacturer: Sloan Optima 111-1.6XL SMO.
 - b. ADA compliant, 1.6 gallon per flush, less handle opening, battery powered infrared sensor, diaphragm or piston valve, chrome plated cover assembly with integral window, flush delay, override button, batteries, low battery flashing LED, infrared sensor adjustment, screw driver check angle stop with vandal resistant cap, sweat solder adaptor, adjustable tailpiece, vacuum breaker flush connection, spud coupling, and flange.
- 5. Carrier:
 - a. Acceptable Manufacturer: J.R. Smith No. 100, or Watts, Wade, Zurn, Josam.
 - b. Cast iron, adjustable, vandalproof trim.

2.3 LAVATORIES

A. Lavatory L-1

- 1. Acceptable Manufacturer: American Standard 0355.012, or Kohler, Sloan.
- 2. Type: ADA compliant, 21 inch x 18 inch vitreous china, wall hung with anti-splash rim, drilled with centers to accommodate faucet and concealed arm carriers.
- 3. Faucet:
 - a. Acceptable Manufacturer: Delta 500.
 - b. Vandal resistant, single lever control, 0.5 gpm spray, open grid drain assembly, chrome finish.
- 4. Supplies:
 - a. Acceptable Manufacturer: McGuire 170LK, or Brasscraft.
 - b. 3/8 inch wall supplies, loose key angle stops, flexible tube riser, escutcheon, chrome finish.
- 5. Trap:
 - a. Acceptable Manufacturer: McGuire 8872C or Brasscraft.
 - b. 1-1/4 inch, 17 gage cast brass adjustable P-trap, cleanout plug, escutcheon, chrome finish.
- 6. Drain and Supply Line Covers:
 - a. Acceptable Manufacturer: True Bro Model 102W or Prowrap.
 - b. ADA compliant, flexible vinyl insulation installed on exposed drain piping, hot water piping and cold water piping.
 - c. ANSI A117.1-2003.
- 7. Carrier:
 - a. Acceptable Manufacturer: J.R. Smith 700, or Wade, Watts, Zurn, Josam.
 - b. Concealed arms with mechanical locking device, high strength steel uprights with block bases of bolting to floor construction.

2.4 SINKS

A. Sink S-1

1. Acceptable Manufacturer: Elkay Series LR, or Just.
2. Type: Single bowl, type 304 stainless steel, 18 gage, self-rimming sound dampened underside, holes drilled to accommodate faucet.
3. Faucet:
 - a. Acceptable Manufacturer: T&S Brass B-2338.
 - b. Chrome plated, single deck mount base mixing faucet with swing spout and overhead spring and spray valve assembly and wall bracket.
4. Supplies
 - a. Acceptable Manufacturer: McGuire, or Brass Craft.
 - b. 3/8 inch wall supplies, loose key angle stops, flexible tube riser, escutcheon, chrome finish.
5. Drain Outlet:
 - a. Acceptable Manufacturer: Elkay LK-35, or Just.
 - b. Chrome plated brass drain, stainless steel basket strainer, chrome plated brass 1-1/2 inch O.D. tailpiece.
6. Trap: 1-1/2 inch P-trap with cleanout, chrome plated.

B. Sink S-2

1. Acceptable Manufacturer: Elkay Series LRAD, or Just.
2. Type: Single bowl, ADA compliant, type 304 stainless steel, 18 gage, self-rimming, 5-1/2 inch deep bowl, drain opening shall be located in back right side or back left side of bowl, sound dampened underside, holes drilled to accommodate faucet.
3. Faucet:
 - a. Acceptable Manufacturer: T&S Brass B-2338.
 - b. Chrome plated, single deck mount base mixing faucet with swing spout and overhead spring and spray valve assembly and wall bracket.
4. Supplies
 - a. Acceptable Manufacturer: McGuire, or Brass Craft.
 - b. 3/8 inch wall supplies, loose key angle stops, flexible tube riser, escutcheon, chrome finish.
5. Drain Outlet:
 - a. Acceptable Manufacturer: Elkay LK-35, or Just.
 - b. Chrome plated brass drain, stainless steel basket strainer, chrome plated brass 1-1/2 inch O.D. tailpiece.
6. Trap: 1-1/2 inch P-trap with cleanout, chrome plated.

C. Sink S-3

1. Acceptable Manufacturer: Elkay WNSF81362, or Just.
2. Type: Single bowl floor mounted sink with legs, type 304 stainless steel, 14 gage. Sink polished to a uniform satin finish. Channel rims, straight line styling. Bowl with center outlet pitched to drain. Sink supported on four stainless steel tubular legs, 1-5/8 inch OD with adjustable bullet shaped feet.
3. Faucet:
 - a. Acceptable Manufacturer: T&S Brass B-2187.

- b. Chrome plated, single wall mount mixing faucet with swing spout and overhead spring and spray valve and wall bracket.
 - 4. Supplies:
 - a. Acceptable Manufacturer: McGuire, or Brass Craft.
 - b. 3/8 inch wall supplies, angle stops, flexible tube riser, escutcheon, chrome finish.
 - 5. Drains:
 - a. Acceptable Manufacturer: Elkay LK-24-RT or Just.
 - b. Three drains, each consisting of stainless steel strainer, brass body and roto handle, 1-1/2 inch O.D. tailpiece.
- D. Sink S-4
 - 1. Acceptable Manufacturer: Elkay WNSF1362 (custom).
 - 2. Type: Single bowl floor mounted sink with legs, type 304 stainless steel, 14 gage, ADA compliant. Sink polished to a uniform satin finish. Channel rims, straight line styling. Bowl with center outlet pitched to drain. Sink supported on four stainless steel tubular legs, 1-5/8 inch OD with adjustable bullet shaped feet.
 - 3. Faucet:
 - a. Acceptable Manufacturer: T&S Brass B2187.
 - b. Chrome plated, single wall mount mixing faucet with swing spout and overhead spring and spray valve and wall bracket.
 - 4. Supplies:
 - a. Acceptable Manufacturer: McGuire, or Brass Craft.
 - b. 3/8 inch wall supplies, angle stops, flexible tube riser, escutcheon, chrome finish.
 - 5. Drains:
 - a. Acceptable Manufacturer: Elkay LK-24-RT or Just.
 - b. Three drains, each consisting of stainless steel strainer, brass body and roto handle, 1-1/2 inch OD tailpiece.
- E. Sink S-5
 - 1. Acceptable Manufacturer: Elkay WNSF81362, or Just.
 - 2. Type: Single bowl floor mounted sink with legs, type 304 stainless steel, 14 gage. Sink polished to a uniform satin finish. Channel rims, straight line styling. Bowls with center outlets pitched to drain. Sink supported on four stainless steel tubular legs, 1-5/8 inch OD with adjustable bullet shaped feet.
 - 3. Faucet:
 - a. Acceptable Manufacturer: T&S Brass B-2187.
 - b. Chrome plated, single wall mount mixing faucet with swing spout and overhead spring and spray valve and wall bracket.
 - 4. Supplies:
 - a. Acceptable Manufacturer: McGuire, or Brass Craft.
 - b. 3/8 inch wall supplies, angle stops, flexible tube riser, escutcheon, chrome finish.
 - 5. Drains:
 - a. Acceptable Manufacturer: Elkay LK-24-RT or Just.
 - b. Three drains, each consisting of stainless steel strainer, brass body and roto handle, 1-1/2 inch OD tailpiece.

F. Sink S-6

1. Acceptable Manufacturer: Elkay WNSF1362 (custom).
2. Type: Single bowl floor mounted sink with legs, type 304 stainless steel, 14 gage, ADA compliant. Sink polished to a uniform satin finish. Channel rims, straight line styling. Bowls with center outlet pitched to drain. Sink supported on four stainless steel tubular legs, 1-5/8 inch OD with adjustable bullet shaped feet.
3. Faucet:
 - a. Acceptable Manufacturer: T&S Brass B2187.
 - b. Chrome plated, single wall mount mixing faucet with swing spout and overhead spring and spray valve and wall bracket.
4. Supplies:
 - a. Acceptable Manufacturer: McGuire, or Brass Craft.
 - b. 3/8 inch wall supplies, angle stops, flexible tube riser, escutcheon, chrome finish.
5. Drains:
 - a. Acceptable Manufacturer: Elkay LK-24-RT or Just.
 - b. Three drains, each consisting of stainless steel strainer, brass body and roto handle, 1-1/2 inch OD tailpiece.

G. Sink S-7

1. Sink furnished by Owner.
2. Faucet:
 - a. Acceptable Manufacturer: T&S Brass B2187.
 - b. Chrome plated, single wall mount mixing faucet with swing spout and overhead spring and spray valve and wall bracket.
3. Supplies:
 - a. Acceptable Manufacturer: McGuire, or Brass Craft.
 - b. 3/8 inch wall supplies, angle stops, flexible tube riser, escutcheon chrome finish.
4. Drains:
 - a. Acceptable Manufacturer: Elkay LK-24-RT or Just.
 - b. Three drains, each consisting of stainless steel strainer, brass body and roto handle, 1-1/2 inch OD tailpiece.

H. Sink S-8

1. Sink furnished by Owner.
2. Faucet:
 - a. Acceptable Manufacturer: T&S Brass B-2338.
 - b. Chrome plated, single deck mount mixing faucet with swing spout and overhead spring and spray valve and wall bracket.
3. Supplies:
 - a. Acceptable Manufacturer: McGuire, or Brass Craft.
 - b. 3/8 inch wall supplies, angle stops, flexible tube riser, escutcheon chrome finish.
4. Drains:
 - a. Acceptable Manufacturer: Elkay LK-24-RT or Just.
 - b. Three drains, each consisting of stainless steel strainer, brass body and roto handle, 1-1/2 inch OD tailpiece.

2.5 MOP RECEPTORS

A. Mop Receptor MR-1

1. Acceptable Manufacturer: Fiat, or Flore Stone.
2. Type: One piece precast terrazzo, integral cast drain, stainless steel protective cap on exposed sides, size as scheduled on Drawings.
3. Faucet:
 - a. Acceptable Manufacturer: T&S Brass B-0665-BSTP.
 - b. Polished chrome plated with vacuum breaker, lever handles, threaded spout, rubber hose, wall hook, loose key stops.
4. Accessories:
 - a. Acceptable Manufacturer: Fiat.
 - b. Mop Hanger: Stainless steel with three rubber tool grips.
 - c. Wall Guard: Heavy gage stainless steel.

2.6 SHOWERS

A. Shower SH-1

1. Acceptable Manufacturer: Acryline G3636 ADA-3/4”.
2. Type: One piece seamless acrylic with grab bars, curtain rod, “L” shaped fold-up seat, drain, and slip resistant bottom. ANSI A117.1, ADA compliant.
3. Shower Valve:
 - a. Acceptable Manufacturer: Delta 1325-WSHDF.
 - b. Valve: Balanced-temperature and balanced-pressure shower set provided with color coded dial plate, lever handle, diaphragm balancing chamber with poppet type anti-line valves and inlet checkstops.
 - c. Shower Assembly: Chrome plated, self-cleaning volume control, 2.5 gpm flow restrictor, spray pattern vandalproof provided with anchor plate and remote lever diverter valve.
4. Water Retaining Strip:
 - a. Acceptable Manufacturer: Lasco, or Acryline.
 - b. Synthetic water retaining strip mounted at threshold of shower using a double sided adhesive backing.

2.7 ELECTRIC WATER COOLERS

A. Electric Water Cooler EWC-1

1. Acceptable Manufacturer: Halsey Taylor HTV8BL-Q, or Oasis, Elkay, Acorn Aqua.
2. Type: Twin units, wall mounted, ADA compliant, lead free, electric water cooler shall have a minimum capacity of 8 gallons per hour of 50 degrees F drinking water with an 80 degrees F inlet water temperature and a room temperature of 90 degrees F. Unit shall be equipped with front and side push bar water controls, have a stainless steel receptor, and vinyl clad steel cabinet, color selected by Architect. Include flexible power cable with three pronged grounded male plug. Bubbler stream shall be self-regulating.

3. Trap: 1-1/4 inch P-trap with cleanout.
4. Supplies:
 - a. Acceptable Manufacturer: McGuire ST16, or Brasscraft.
 - b. 1/2 inch wall supply, brass stem, sweat inlet, 3/8 inch outlet.

2.8 EMERGENCY SHOWER/EYEWASHES

- A. Barrier Free Floor Mounted Combination Unit ESH-1
 1. Acceptable Manufacturer: Haws Model 8200, or Guardian.
 2. Shower: 10 inch diameter ABS plastic shower head, stay open chrome plated brass ball valve, rigid stainless steel pull rod, 30 gpm chrome plated brass flow control assembly, 9 inch diameter floor flange with 1-1/4 inch hot dip galvanized steel pipe.
 3. Eye/Face Wash: Spray heads which produce a spray pattern that covers entire facial area with dust covers which automatically release when eye/face was is activated, stainless steel push flag operates a stay open chrome plated brass ball valve with a stainless steel ball and stem, automatic pressure compensation devices for 30 - 90 psi.
 4. Sign: Emergency sign included.
 5. Shall meet ANSI Z358.1 requirements.

PART 3 - EXECUTION

3.1 INSTALLATION

- A. Plumbing fixtures shall be installed square with wall, in line, and level, to give a uniform appearance. Plumbing trim and exposed supply and waste piping, including traps, shall be polished chrome plated brass, unless otherwise specified.
- B. Each hot and cold water connection to plumbing fixtures and equipment shall be valved, if not provided with integral stops as specified herein.
- C. Calk space watertight between plumbing fixtures and wall or floor; silicone, white for all white fixtures, clear for all other colors.
- D. Contractor shall be responsible to coordinate the orientation of all plumbing fixtures (i.e. left-hand, right-hand) with ADA requirements and general building conditions. Model numbers are listed for plumbing fixtures to illustrate a standard of quality for materials and indicate a specific style.
- E. Shower control valves provided with high limit stops shall be adjusted to a maximum hot water temperature setpoint of 105 degrees F.

3.2 CONNECTIONS TO EQUIPMENT SUPPLIED BY OTHERS

- A. Rough in and make final connections to equipment supplied by Owner. Each hot and cold water connection shall be valved. Verify locations for roughing-in with the equipment supplier, prior to beginning work.

3.3 TESTING

- A. Plumbing fixtures shall be filled with water and checked for leaks or retarded flow. Remove and clean all aerators.

****END OF SECTION****

**SECTION 120180
SPECIAL PIPING SYSTEMS**

PART 1 - GENERAL

1.1 WORK INCLUDED

- A. The Work of this Section shall consist of the labor, materials and equipment required for installation of the following piping systems:
 - 1. Compressed Air
 - 2. Acid Waste
 - 3. Vacuum
- B. Compressed air piping shall be extended from air compressor and distributed to areas and equipment specified herein.
- C. Acid waste shall be collected and extended to neutralization tank, and discharged to sanitary sewer system.
- D. Vacuum piping shall be installed for future vacuum pump and distributed to vacuum stations.

1.2 SUBMITTALS

- A. Submit for approval in accordance with specified submittal procedures:
 - 1. Air Compressors
 - 2. Air Dryers
 - 3. Filters/Separators
 - 4. Air Pressure Regulators
 - 5. Neutralization Tanks

PART 2 - PRODUCTS

2.1 AIR COMPRESSOR

- A. Acceptable Manufacturer: Quincy Series QRDT, or Gardner Denver, Ingersoll Rand.
- B. Type: Air cooled, reciprocating, two stage, oil-less, reciprocating, tank mounted compressor with v-belt drive and metal guard.
- C. Tank: Horizontal steel air receiver, ASME.

- D. Provided with pressure gage, ASME relief valve, check valve, air filter, pressure switch, service valve, and manual drain valve.
- E. Motor: NEMA, open drip proof.
- F. Warranty: 10,000 hours or 3 years.
- G. Controls: Start stop control, motor starting switch.
- H. Control Panel: Duplex, disconnect NEMA 12 enclosure, automatic alternation, lead select/auto switch, pilot lights, 120v control circuit, circuit breakers.

2.2 AIR DRYER

- A. Air Acceptable Manufacturer: Hankison Series PR, or Ingersoll-Rand, Zeks.
- B. Type: Refrigerated compressed air dryer, non-cycling, hermetically sealed refrigeration system, air cooled, hot gas bypass valve, high temperature light, full charge of CFC free refrigerant.
- C. Heat exchanger tube in tube design, non-fouling assemblies. Pressure vessel shall be U.L. approved.
- D. Filter: Two stage separator/filter, removes water droplets and solids 3 microns or larger.
- E. Cabinet: Heavy gage metal.

2.3 AIR FILTER

- A. Acceptable Manufacturer: Hankison, or Zeks, Ingersoll-Rand, Norgen.
- B. Type: 1 micron coalescer filter, housing shall be aluminum, zinc, or steel with corrosion resistance (interior and exterior), 250 psi maximum working pressure, internal/external automatic drain, differential pressure indicator and/or gages, liquid level indicator.

2.4 AIR FILTER/SEPARATOR

- A. Acceptable Manufacturer: Hankison, or Zeks, Ingersoll-Rand.
- B. Type: Remove solids and liquid 3 microns and larger, housing shall be aluminum, zinc, or steel with corrosion resistance (interior and exterior), 250 psi maximum working pressure, internal/external automatic drain, differential pressure indicator and/or gauges, liquid level indicator.

2.5 AIR PRESSURE REGULATOR

- A. Acceptable Manufacturer: Norgen.
- B. Regulators shall be non-relieving type T handle adjustment and integral pressure gage.

- C. Pressure Range: 2 to 125 psig.

2.6 NEUTRALIZING TANK

- A. Acceptable Manufacturer: Town & Country Plastic Inc., or Enfield.
- B. Type: Seamless high density polyethylene neutralization tank, with inlet, outlet and vent connections.
- C. Neutralizing Stone: Provide full charge of limestone.

PART 3 - EXECUTION

3.1 INSTALLATION

- A. Install compressed air piping as indicated on Drawings with pipe, fittings, suitable drips, valves and hangers.
- B. Horizontal acid waste lines shall be sloped as indicated on Drawings. Change in direction shall be made with wye fittings, combination wye and eighth bends or one eighth bends. Offsets in acid waste pipes will not be permitted where offsets can be avoided. Offsets shall be made with 45 degree bends or similar fittings. Acid waste piping shall be installed in accordance with manufacturer's recommendations. Acid waste pipe exposed to damage by sharp surfaces shall be protected with grommets or sleeves of rubber or plastic.

3.2 PURGING AND TESTING

- A. Compressed Air Piping
 - 1. After installation of piping, but before installation of outlet valves, connections to compressor, lines shall be blown clear by means of oil-free dry air. Piping shall be tested with oil-free dry air to 175 psig. Test shall be held for 4 hours with a maximum pressure drop of 2 psi.
- B. Acid Waste Piping, Gravity

1. Water Test: Water test shall be applied to drainage system either in its entirety or in sections after rough piping has been installed. If applied to entire system, all openings in piping shall be tightly closed, except highest opening, and system shall be filled with water to point of overflow. If system is tested in sections, each opening shall be tightly plugged except highest opening of section under test, and each section shall be filled with water, but a section shall not be tested with less than 10 foot head of water. In testing successive sections, at least the upper 10 feet of next preceding section shall be tested, so that a joint or pipe in building, except uppermost 10 feet of system, shall not have been submitted to a test of less than 10 foot head of water. Water shall be kept in system or in portion under test for one hour before inspection starts. System shall then be tight at all points. If any leaks occur, those areas shall be corrected and section shall be retested.

****END OF SECTION****

**SECTION 120190
FUEL GAS PIPING AND SPECIALTIES**

PART 1 - GENERAL

1.1 WORK INCLUDED

- A. The Work of this Section shall consist of the labor, materials and equipment required for installation of fuel gas piping and specialties.
- B. Propane gas shall be extended from existing building propane gas system.

1.2 RELATED SECTIONS

- A. Section 220510, Plumbing Piping and Pipe Fittings: Propane gas piping and pipe fittings.

1.3 SUBMITTALS

- A. Submit for approval in accordance with specified submittal procedures:
 - 1. Gas Regulators
- B. Submit written verification of piping system testing procedures specified herein.

PART 2 - PRODUCTS

2.1 GAS REGULATORS

- A. Type GR-1
 - 1. Acceptable Manufacturer: Fisher Controls Series S 100, Actaris.
 - 2. Body: High tensile iron body and precision die cast aluminum diaphragm casing. Spring loaded type.
 - 3. Valve Disc and Orifices: Shall be renewable without breaking any pipe joints.
 - 4. Relief Valve: Built into unit which automatically opens to relieve excess pressure.
 - 5. Vent: Weather and insect resistant.

PART 3 - EXECUTION

3.1 INSTALLATION

- A. Piping

1. Extend propane gas piping to equipment or specified herein with suitable drips and cocks.
2. All welding of gas piping shall be performed by welders approved by local gas company.
3. All exterior gas piping shall be primed and painted.
 - a. Exterior semi-gloss, acrylic enamel: 2 coats over rust-inhibitive primer.
 - b. Color selected by Owner.
4. Provide cathodic protection on gas piping as required by local gas company.
5. Rough-in and make final connection to Owner furnished gas fired equipment. Verify locations for roughing-in with equipment supplier prior to start of work.

B. Gas Regulators

1. The gas regulator vent shall be extended to the exterior. Vent piping shall be installed per local codes and manufacturer's recommendations.
2. The gas regulator vent shall be sized as indicated on the drawings, but not less than the connection size to the regulator.

3.2 PURGING AND TESTING

- A. After installation of piping, but before installation of outlet valves, propane gas piping shall be blown clear by means of oil free dry air or nitrogen.
- B. Propane gas piping shall be tested in accordance with recommendations of the National Fire Protection Association (NFPA 96), American Gas Association, and local gas company.

END OF SECTION

**SECTION 120200
WIRING OF PLUMBING EQUIPMENT**

PART 1 - GENERAL

1.1 WORK INCLUDED

- A. The Work of this Section shall include the power and control wiring of plumbing equipment.

PART 2 - PRODUCTS

2.1 MATERIALS

- A. Plumbing Contractor shall provide equipment with controls, starters and related items as specified in various Sections of Section 12.
- B. Where plumbing equipment specified without starters or controllers, Electrical Contractor shall provide same as specified herein.
- C. Electrical Contractor shall provide all power wiring unless specifically noted otherwise.
- D. Plumbing Contractor shall furnish and install all control wiring unless specifically noted otherwise.

PART 3 - EXECUTION

3.1 INSTALLATION

- A. Plumbing equipment shall be wired in accordance with the following schedule:

Key:

	Item furnished by.....
	Item installed by....
	Item wired by.....

the respective trade according to the following designations:

P = Plumbing Contractor
E = Electrical Contractor

Plumbing Equipment Wiring Schedule																	
Equipment		Disconnect Means				Controllers					Control Devices						
		Remote Disconnect Switch	Integral Disconnect Switch	Wall Switch	Cord & Plug	Magnetic Motor Str	Combination Motor Str	Manual Motor Str	VFD with Disconnect	Contactor	Line Voltage Stat	Low Voltage Stat	Aquastat	Duct Smoke Detector	Control Panel	Flow/Press/Level Switch	BAS/ATC Control
Gas Fired Water Heater DWH-1 & DWH-2	P							P									
	P							P									
	E							E									
Recirc. Pump CP-1	P											P					H
	P											P					H
	E											E					H
Air Compressor AC-1	P													P			
	P													P			
	E													E			
Air Dryer AD-1	P																
	P																
	E																
Electric Water Cooler EWC-1	P				P												
	P				P												
	E				E												

B. Unless noted, Contractor responsible for wiring of an item shall be responsible for furnishing and installing all wiring for that item and making all connections associated with this wiring.

END OF SECTION

Bradley9

\$19-310, S19-310F, S19-310FSS, S19-310SB Combination Drench Shower/Eyewash Unit

- Exceeds American National Standard Z35B.1 Specifications
- Galvanized Steel Protected with 1111 BrakTeel® Safety Yellow Coating or All Steel (S19-310FSS)
- Combination Units may be Top-Supplied or Floor-Supplied
- Universal Identification Sign and Inspection Tag Included
- Full, One-Year Warranty
- SpinTech® Showerheads are covered by one or more of the following patents: 3-1-13446; 0594,089; Reg. Comm. Des. 0001079560-0001. Other patents pending.
- Classified by Underwriters Laboratory Inc. to ANSI Z358.1



Specifications

Combination Drench Shower/Eyewash Unit saves space and fits easily into any work environment. Shower valve operates quickly by a pull rod with a triangular handle. Shower provides a superior flushdown with a more even spray pattern. Eyewash operated by a large, highly visible push handle. Safe, steady water flow, under varying water supply conditions from 30-90 PSI is assured by integral flow control in the sprayhead assembly. NOTE: The ANSI Z358.1 standard requires a continuous supply of flushing fluid at a minimum of 30 PSI flowing pressure.

[m] This product fixture is not intended to dispense water for human consumption through drinking or for preparation of food or beverages.

Model	Description
D S19-310	Drench Shower/Eyewash- Plastic Showerhead and Bowl
D S19-310F	Drench Shower/Eyewash- Stainless Steel Showerhead and Bowl
D S19-310FSS	Drench Shower/Eyewash- All Stainless Steel
D S19-310SB	Drench Shower/Eyewash- Plastic Showerhead and Stainless Steel Bowl
D 819-1100	Navigator EFX25- Emergency Thermostatic Mixing Valve

Recommended Option:
Navigator Series 2100 EFX25
Emergency Thermostatic Mixing Valve

NAVIGATOR

Satisfies ANSI Z358.1
tepid water requirements

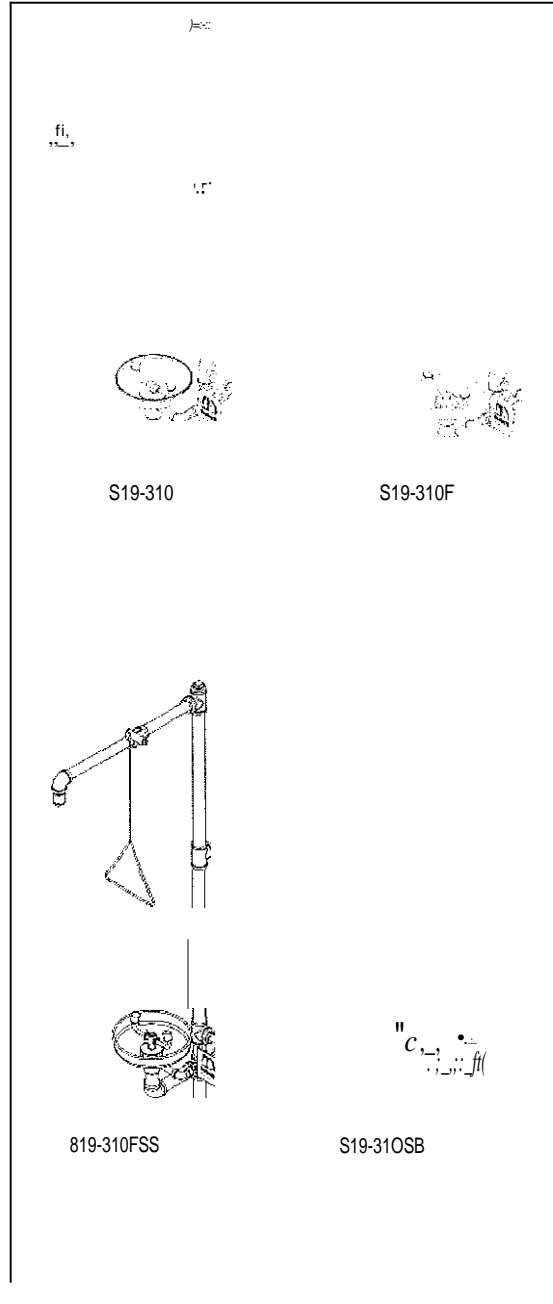

Bradley

\$19-310, S19-310F, S19-310FSS, S19-310SB Combination Drench Shower/Eyewash Unit

Standard Equipment

S11111TecTri Showerhead

Standard showerhead is 3.1" (78.7mm) diameter highly visible yellow impact-resistant plastic (Model S19-310F includes a .00" [273mm] diameter corrosion-resistant stainless steel shroud). High performance corrosion-resistant stainless steel showerhead mixtures 1" (38mm) in diameter (S.19-310FSS only). Spin Tee drench showerhead features integral 22 GPM flow control, conserving water and helping to accurately size your tepid water system.

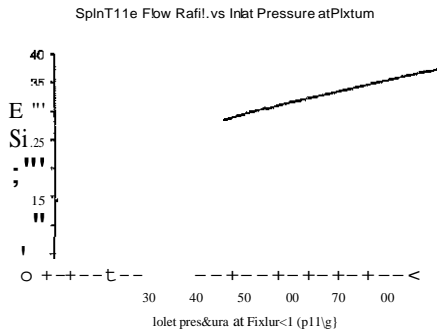

Shower Valve

Chrome-plated brass 1" FNPT stay-open ball valve. Operated by a stainless steel rod with triangular handle. S-19-310FSS is all stainless steel.

Eye Wash Bowl

10" (254mm) diameter yellow impact-resistant plastic or 10" (273mm) diameter corrosion-resistant stainless steel.

Standard Sprayhead Assembly

Chrome-plated brass sprayhead with twin soft-flow eyewash shields and protective sprayhead covers. Safe, steady water flow under varying water supply conditions from 30-90 PSI is assured by integral flow control in the sprayhead assembly. S19-310FSS is stainless steel.

Eyewash Valve

Chrome-plated brass 1/2" MPT stay-open ball valve. Hand operated by highly visible yellow PVC push handle. S19-310FSS is all stainless steel.

Pipe and Fillings

1/2" galvanized steel with BradTec & Jfety yellow coating. S19-310FSS is stainless steel.

Water Supply

1/2" MPT.

191 Local codes may require the installation of a backflow prevention valve

to complete proper installation. Compliance with local codes is the responsibility of the installer. Valve must be tested annually to verify that it is functioning properly. Backflow prevention valves are not included with this fixture and may be supplied by the contractor or purchased from Bmdle_v Corporation.

Bracley 9

519-310, S19-310F, S19-310FSS, S19-310SB Combination Drench Shower/Eyewash Unit

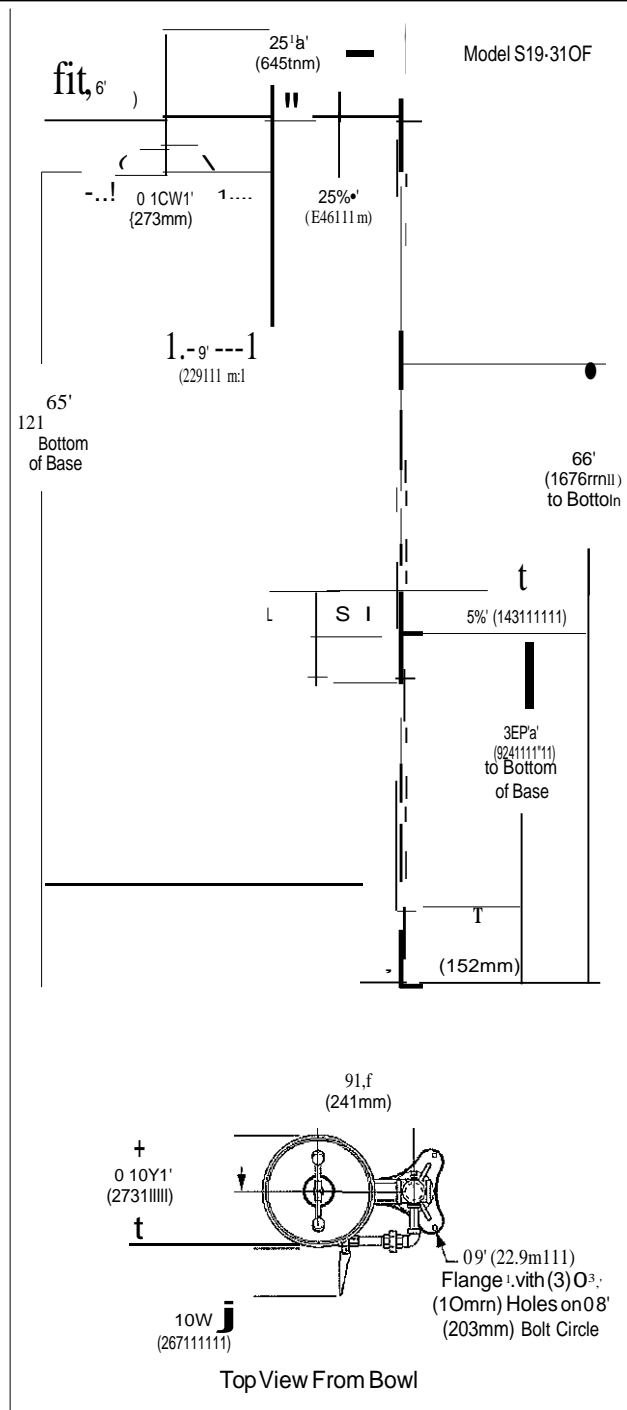
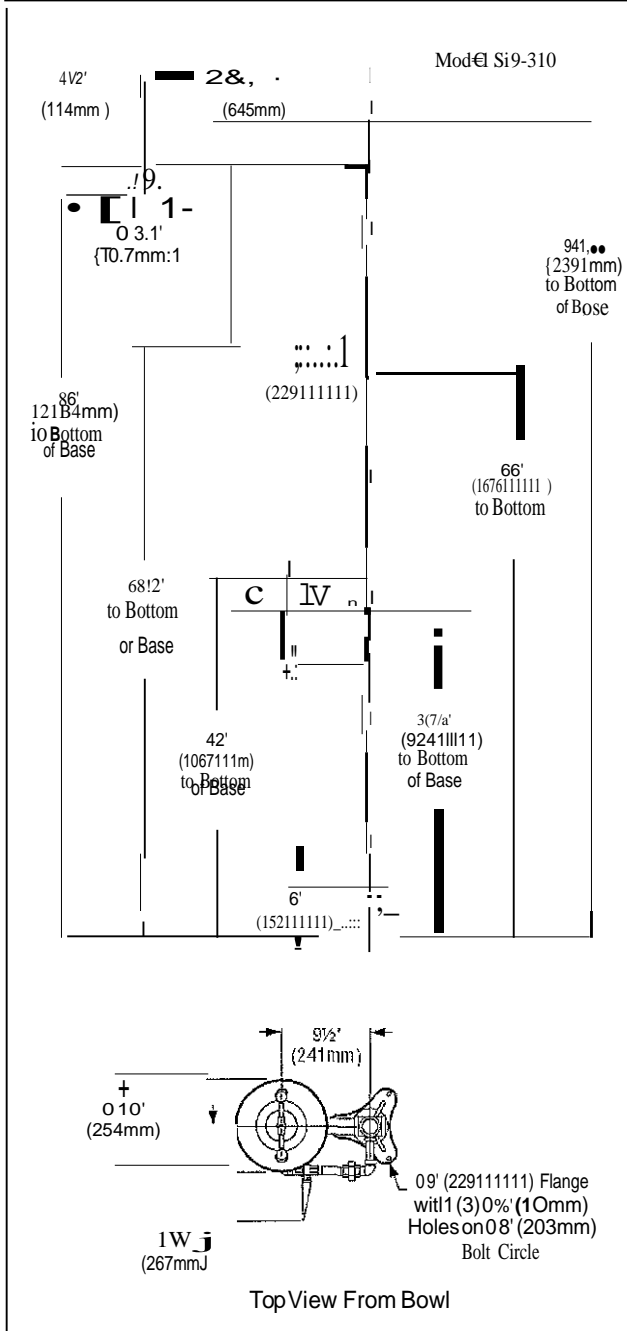

All dimensions assume standard thread engagement. Variations in manufacturing allow for +/- .003" (3mm) per threaded joint. To find the tolerance of a dimension, add the number of threads between a dimension and multiply it by .003" (3mm)

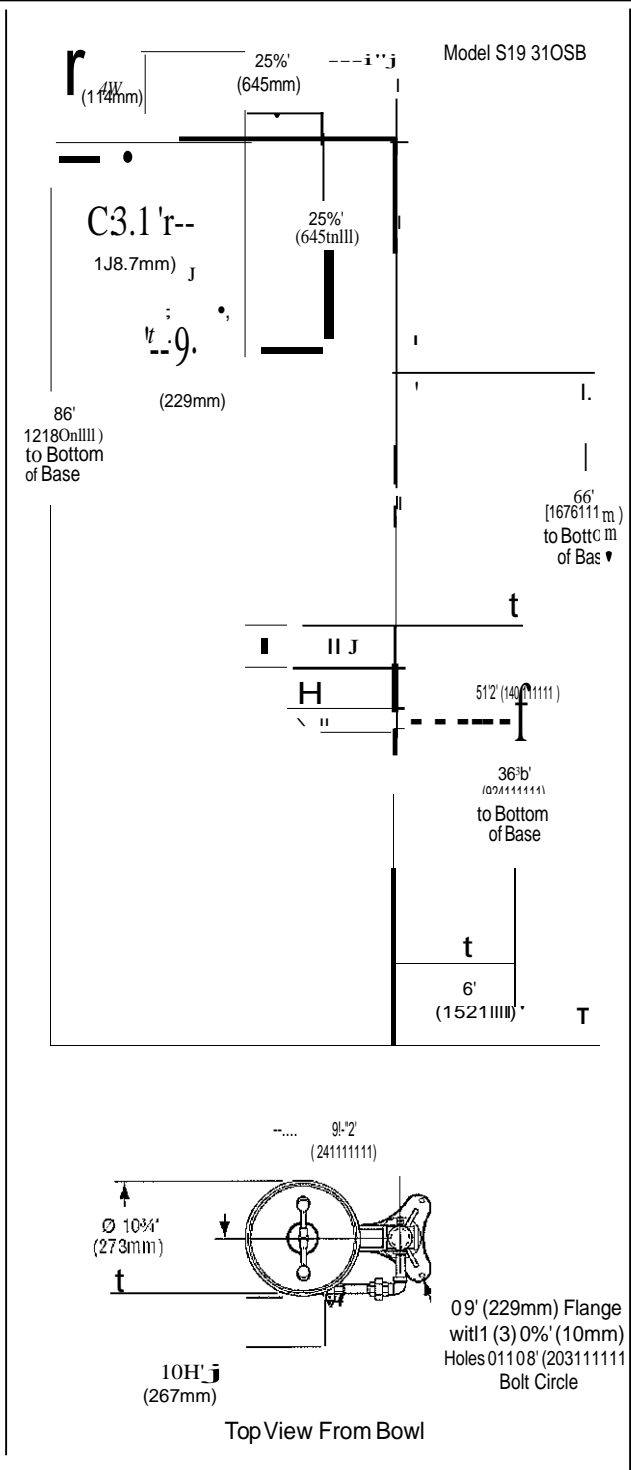
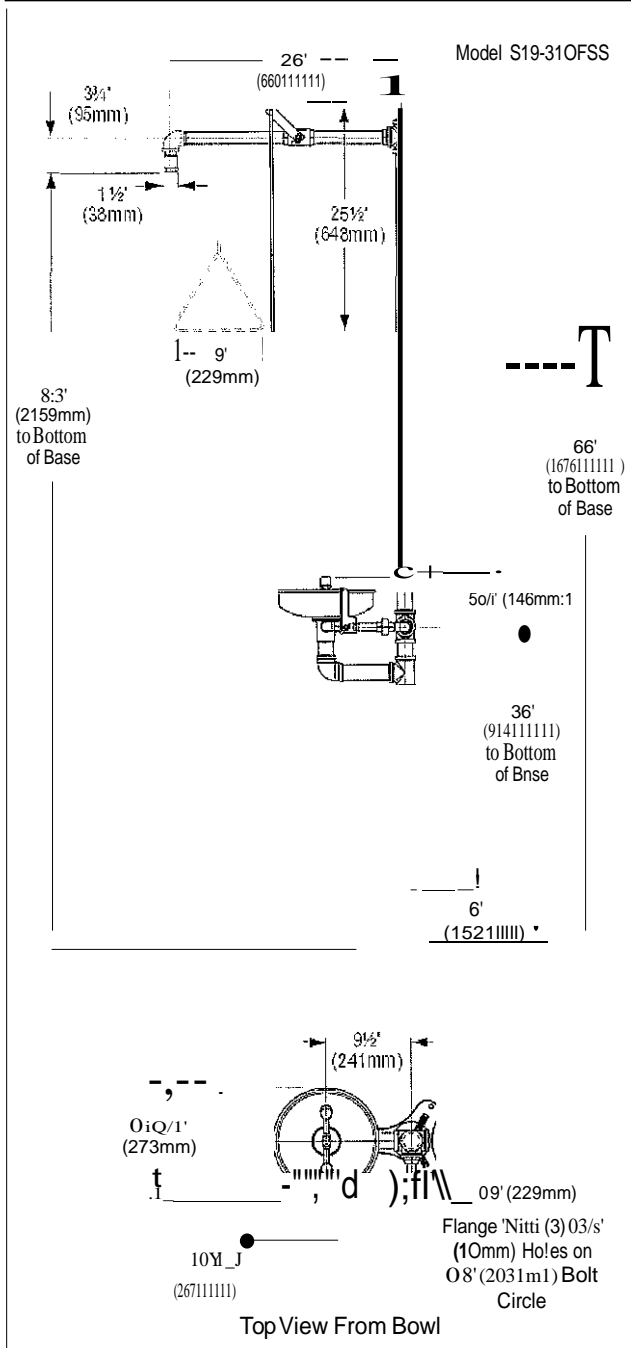

All dimensions assume standard thread engagement. Variations in manufacturing allow for +/- 1/16" (3mm) per thread joint. To find the tolerance of a dimension add the number of thread joints in between a dimension and multiply it by 1/16" (3mm).

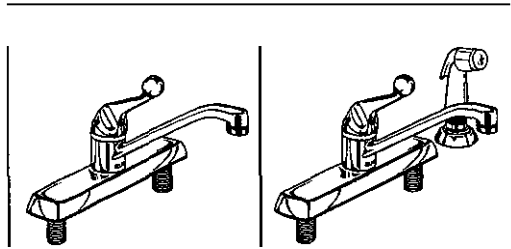

© DELTA.

ICITCHEN FAUCETS

- Single Handle
- Deck Mount
- 3 and 4 Hole Sink Applications
- 8" Centers
- Quick Snap® Vegetable Sprayer Hose Installation on Model 420 Series

(12Q ... / I

420

Submitted Model No.: _____

Specific Features: _____

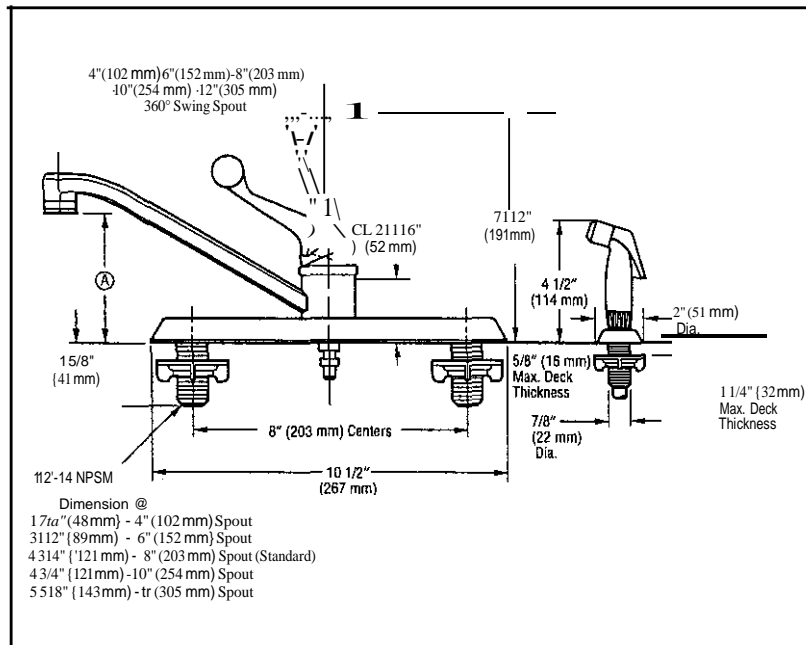

c@us

LISTED

UL U81 & to US and Canadian
Safety Standards and Class 1 listed
in accordance with
ANSI NSF 61
21PL

COMPLIES WITH:

- ASME A112.18.1
- CSA 8125
- NSF 61
- ITT Indicates ADA compliance to LQJ ICC/ANSI A117.1
- IAPMO listed
- CSA Certified

- Single handle kitchen deck faucets for mounting on three and four hole sinks
- Solid brass fabricated body.
- 8" /203 mm) long spout swings 360°.
- Lever handle. Control mechanism shall be of the rotating stainless steel ball type with replaceable non-metallic seats operating in stainless steel lined sockets.
- Control handle shall return to neutral position when valve is turned off.
- 1/2"-14 NPSM threaded male inlet shanks.
- Model 420 series with spray attachment has anti-siphon device as integral part of valve body.
- Quick Snap® vegetable sprayer hose installation on model 420 series.

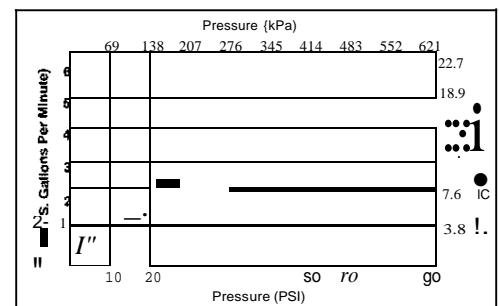

Delta reserves the right (1) to make changes in specifications and materials, and (2) to change or discontinue models, both without notice or obligation. Dimensions are for reference only.

Standard Features	
Washerless	
Three Hole Installation	
Four Hole Installation	
Lever Handle	
8" (203 mm) Long Spout Sw'ings 360°	
1/2" - 14 NPSM Male Threaded Inlet Shanks	
45" (1143 mm) Quick Connect Hose and Spray Assembly	
White Sprayhead	
Chrome Finish	

Available Options for Field Conversion:

- 4" (102 mm) long swing spout. Order RP5881.
- 6" (152 mm) long swing spout. Order RP9633.
- 10" (254 mm) long swing spout. Order RP5653.
- 12" (305 mm) long swing spout. Order RP6042.
- 6" (152 mm) long elbow handle with red/blue indicators. Order RP5645.
- Swivel Aerator. Order RP2189.

.DELTA.
FAUCET COMPANY

Indianapolis, Indiana 46280
A Division of Masco Corporation of Indiana
© 2002 Masco Corporation of Indiana

ffe

Jfo

IP:

500/501

510-wF

16.1

520

505

1/2" - 14 NPSM

Submitted Model No.:

Specific Features:

DELTA LAVATORY FAUCETS

- Single Handle
- Deck Mount
- 2 and 3 Hole Sink Applications
- 4" Centerset

c@us

LISTED
UL Underwriters Laboratories and Canadian
Safety Standards Institute Classified
To accordance with
ANSI/NSF610
21PL



COMPLIES WITH:

- ASME A112.18.1M-1996
- CSA 8125-93
- Indicates ADA compliance to LQJ CABO/ANSIA! 17.1-1992
- JAPMO Listed
- CSA Certified
- ASTM F409 for non-metallic drain

STANDARD SPECIFICATIONS:

- Single handle lavatory deck faucets for exposed mounting on two and three hole sinks.
- 4" (102 mm) centerset
- Solid brass fabricated body.
- 4 1/2" (114 mm) long spout

of the rotating stainless steel ball type with replaceable non-metallic seats operating in stainless steel lined sockets.

- Control handle shall return to neutral position when valve is turned off.
- Models 500, 501 and 510 and 520 Series supplied with 3/8" O.D. copper supply tubes.
- Models with suffix 'WF' supplied with 1/2"-14 NPSM adapters.
- Models 505 and 525 Series supplied with 1/2"-14 NPSM threaded male inlet shanks.
- Models with Snap-N-Pop-Up® drain have polypropylene pop-up type fitting with plated flange and stopper.
- Models with metal drain have pop-up type fitting with plated flange and stopper.

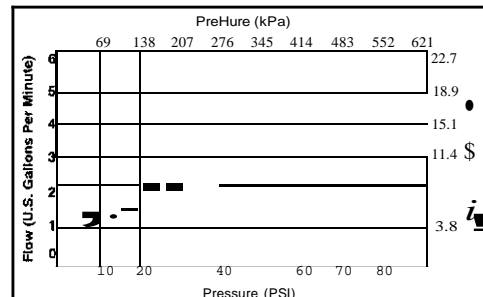
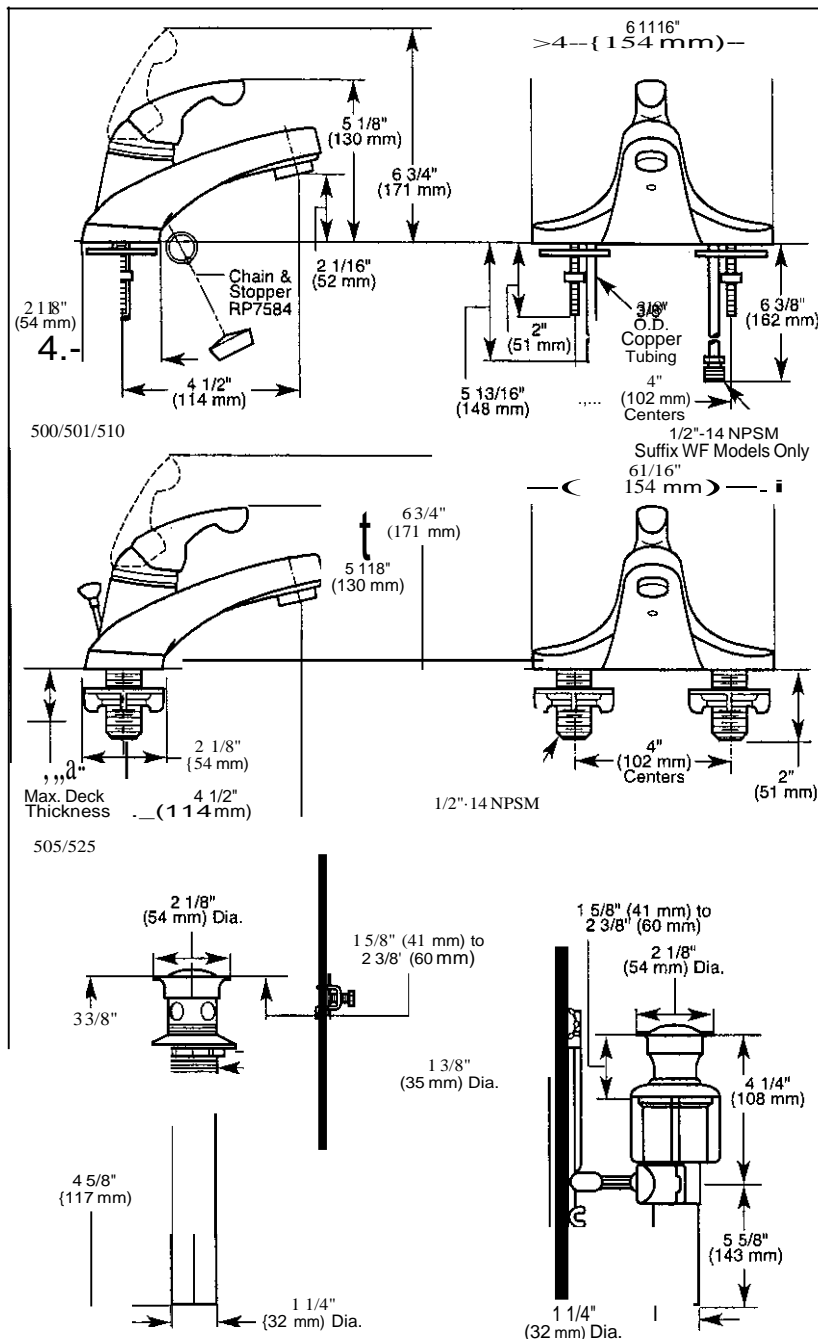

Delta reserves the right (1) to make changes in specifications and materials, and (2) to change or discontinue models, both without notice or obligation. Dimensions are for reference only.

Standard Features	6. 6. &	6. 6. &	6. 6. &	6. 6. &	6. 6. &	6. 6. &	6. 6. &	6. 6. &	6. 6. &	6. 6. &	6. 6. &	6. 6. &	6. 6. &	6. 6. &	6. 6. &
Washerless	●	●	●	●	●	●	●	●	●	●	●	●	●	●	●
Two Hole Installation	●	●	●	●	●	●	●	●	●	●	●	●	●	●	●
Three Hole Installation	●	●	●	●	●	●	●	●	●	●	●	●	●	●	●
4" (102 mm) Centerset	●	●	●	●	●	●	●	●	●	●	●	●	●	●	●
4 1/2" (114 mm) Long Spout	●	●	●	●	●	●	●	●	●	●	●	●	●	●	●
Lever Handle	6.	6.	&	6.	6.	6.	6.	6.	6.	6.	6.	6.	6.	6.	6.
With Chain and Stopper															
No Lift Rod Hole			●	●	●										
With Lift Rod Hole	●	●													
3/8" O.D. Copper Supply Tubes	●	●	●	●	●	●	●	●	●	●	●	●	●	●	●
1/2"-14 NPSM Adapters		●													
1/2"-14 NPSM Male Threaded Inlet Shanks			●	●	●	●	●	●	●	●	●	●	●	●	●
Snap-N-Pop-Up® Drain					●	●	●	●	●	●	●	●	●	●	●
Metal Pop-Up Drain								●	●	●	●	●	●	●	●
No Pop-Up Drain	●	●	●	●	●	●	●	●	●	●	●	●	●	●	●
Chrome Finish	●	●	●	●	●	●	●	●	●	●	●	●	●	●	●
Chrome and 'Brilliance™										●					
Polished Brass Finish															
'Brilliance™ Polished Brass Finish													●	●	
White Finish													●	●	

©DELTA.

FAUCET COMPANY

Indianapolis, Indiana 46280
 A Division of Masco Corporation of Indiana
 © 2001 Masco Corporation of Indiana



T&S BRASS AND BRONZE WORKS, INC. -

2 SADDLEBACK COVE / P.O. BOX 1088 / TRAVELERS REST, SC 29690

PHONE 800-476-4103

FAX 864- 834-3518

REG./A2501
ISO #9002

Model No.

B-0665-BSTP / R

Item No.:

Job Name:

Architect/Engineer Approval:

(Handwritten initials)

Notes:

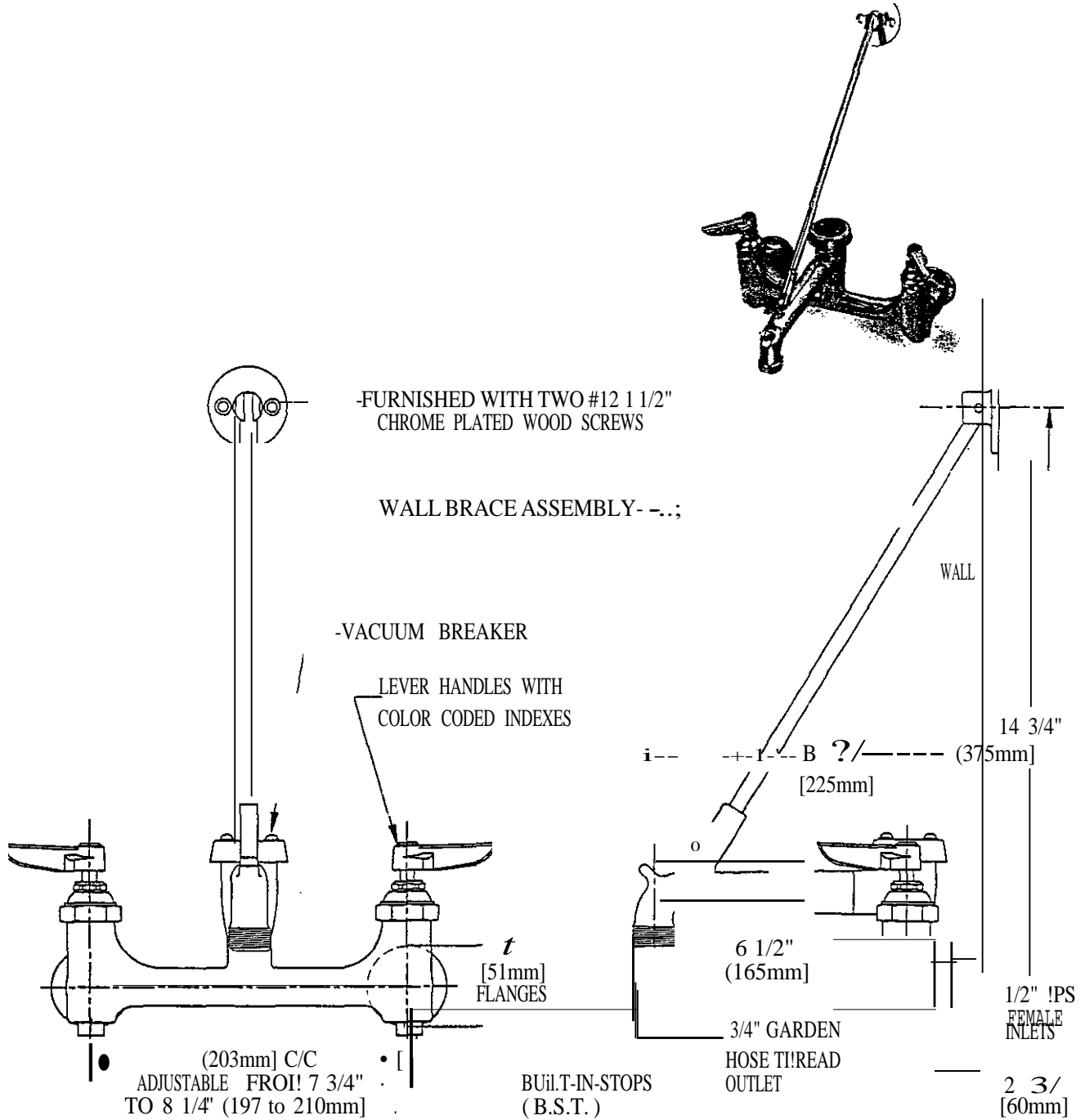

Product description:

SERVICE SINK FAUCET W/ BUILT IN STOPS, VACUUM BREAKER, LEVER HANDLES, WALL BRACE, AND AVAILABLE WITH ROUGH OR POLISHED CHROME FINISH

	MW	ca e: 3" = 1'
CA		a e: 1 1/22/95

Models! Mode/os 120 & 420 Serie

RP5645
 Handle w/Set Screw-Red/Blue Indicators
 Manija con Tornillo de Ajuste-Indicadores: Rojo/Azul

P5

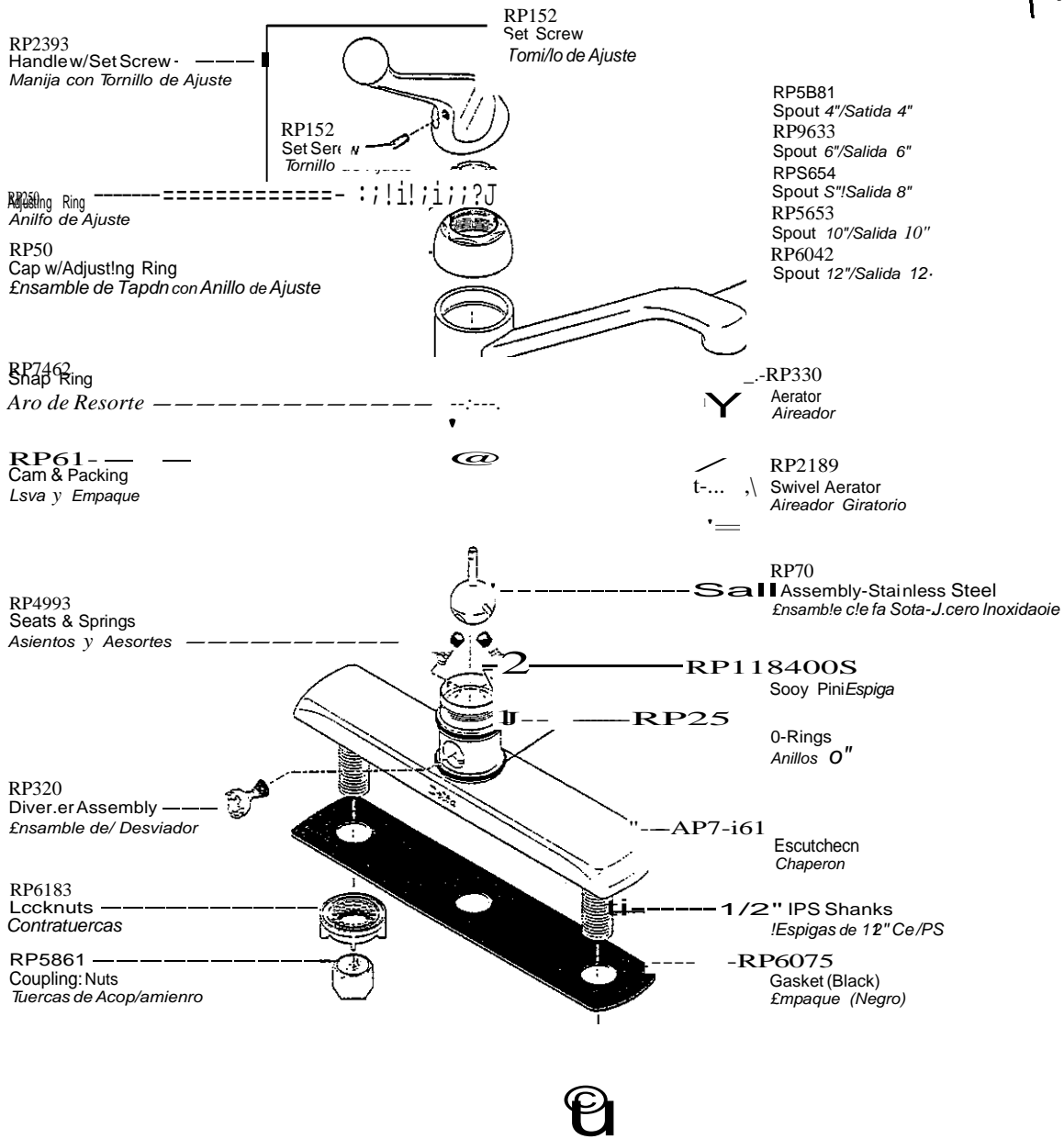

<p>RP22967 Spray Head/Cabeza def Rociador</p> <p>RP6011 RP26878 (6' Hcse/Manguera 6') RP26879 (8' Hcse/Manguera 8')</p> <p>RP6015 Support Assembly/Saporte def Rociador</p>	<p>RP1974 Wrench-Handle/Adiusting Ring Uavanija/Ani/lo de Ajuste</p>	<p>RP3614 Repair Kit Herramientas para Reparaciones</p>
---	--	---

Single Handle Kitchen Faucet 3 Hole without spout

AN-09-01 TUE 12:06 PM

WSC HARRISSBURG

FAX: 71 72331 910

PAGE " 5

Delta Single Handle Kitchen Faucets

• 3 Hole Installation
 • 2.0 gpm @ 60 psi
 7.6 l/min @ 414 kPa
 • 8" OR 8" Centers

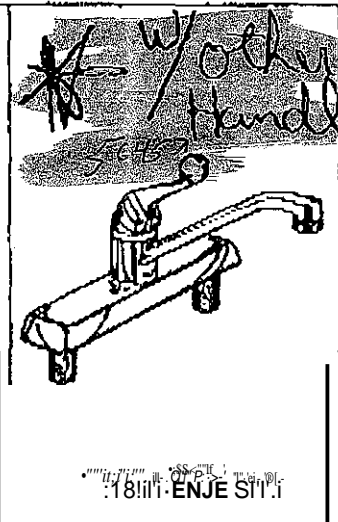
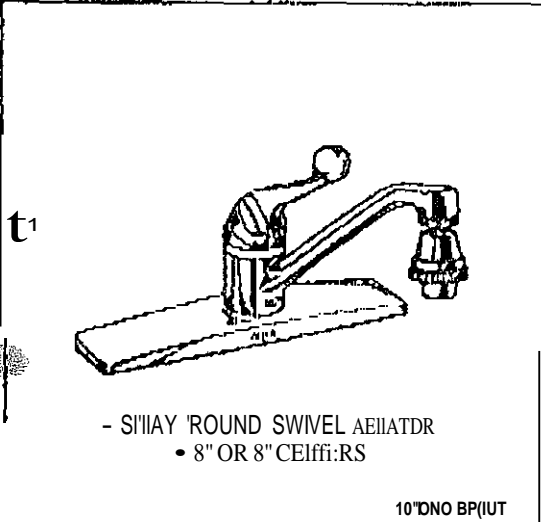

• Wall installation
 • 8" Centers
 • 8" Long spout swings 3600
 • Lever handle
 • Standard with
 • 2.0 gpm @ 80 ps.I
 76 J.)rnl@ 551cPa
.GSJADA

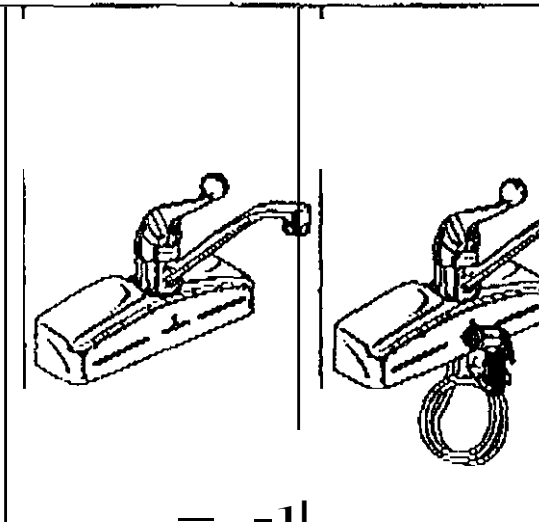

FINISH	MODEL NO	PRICE
Chrome	113.10	3
Chrome	114.75	3
Chrome	111.65	3

FINISH	MOC?,EL No.::=	PRICE	CASE aOAtff ITY
Chrome	200	137.5	3
Chrome	275	I-	3

Delta Single-Handle Kitchen Faucets

4-Hole Installation

8" Long spout
swings 360°
Lever handle

Straight staggered
supply tubes

2.0 gpm @ 60 psi
7.6 L/min @ 414 kPa

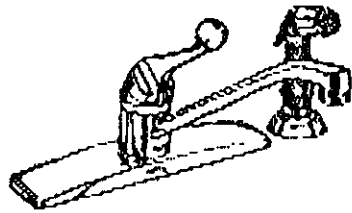

• 6" OR 8" CENTERS

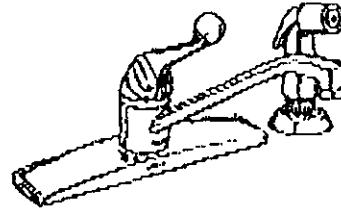

• 6" up CENTERS

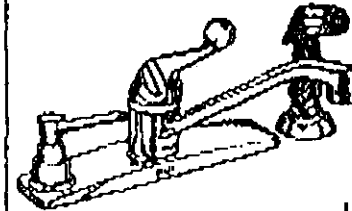

• 1" CENTERS

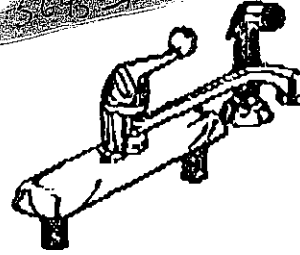

• 8" CENTERS

10" OF SPOUT

FINISH	MODEL NO.	PRICE	CASE QUANTITY
Chrome	400	17.45	12
White	400-WHWF	172.00	1
Chrome	400-WESPW	131.41	12
Chrome	400-0	154.55	3
Chrome	420	139.10	

Single Handle Kitchen Faucets Manya de Palanca para Fregadero

Delta
RP 5645

Models/Modelos 101 & 175 Series

RP2093&

Handle W/Set screw
M.mija COii Tor11/lo
de A1usta

RP152...
Set Screw
Torrotlo dA1usc

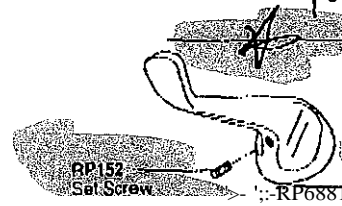

RP5645
Handle w/Set Screw
Red/Blue Indicators
Manija con Tornillo
de Ajuste
Indicadores: Rojo/Azul

Handle for Low
faucets
w/w/o
Spray

RP5QA
Capw/AdjJsting Au*
Ensambls de J'sp6n cnn
Anillo de Ajuste

RPS654A
Spout e*tsallds a*
RP5853A
spoul 10 1st<ta 10*
RP804U

Spout 12"/Sslida 1-

RP618 (f.J(ceplJ+DF mor.lels n1frd. artar 2-7-00)
(Exccplo mo_dr.los flDF fsbfre 11.do dC.'lpr16; de 2-700)
Cam Pacl<mg!Lava y Empaque

RP330A
Aerator
Almador
RP246

Aerator w/Wrench-Va11dal AQS1stanl

Rsslstenla aJ Msflraro

RP6420
Wrench/Llave
RP21U9

Swivel Acratar/G/roll)1o Alre.adut

RP1184QOS
Body Pm/E8pfga

BauAssemblr:-\$tainIC\$Stcol---

EflsambfQ do ls. Bo/-
Acero Inoxlcfblo

AP4993
Sals & Springs

Asfenlosy Rssol1tr

RP2S
O-Rings
Antnos "O".

APJ20
Divcnar Assnmbly
CnsambfJ dat OesviiL Uor

RP5786&
Base w/Gaske1
Bnse con Empaque

1/2" IPS. Adaptors--WF ModeJi; Orly
Ad<lpf,9dDf8\$ de JPS 112--S610 Modelos WF

AP6803
Mounlmg Brac:kcl
Abrnzadera do Manlur:

RPt:1694
Spacer
sepcirador

RP5861

Coupling Nuts-WF Modols Only
Tuerc. 1s de Acoplam/enta-
S6to Modcfo\$ y/F

RPS785
Nut & Wrench
TIIBtcB

RP30394 - 101 & 175 Series
Thick Deck Mounting Kit (For 2 1/2" Max. Thick Decks)
Juego de herramientas para instalaci6n en bordes gruesos
(Para 2 1/2" max de grosor de bordes)

-nP22gs7
Spray Hcdcl 1hC1Z del Re<;iRdor

RP6011
RP2687111 (6' HosEl/Msngu&f6')
RP26879 (8' Hose/Manusra 8')
Spray & Hoio p.embl
)_En58111blo de la M11ngue1ay Raci.1dot

nP0015
Support Ai;smbly/Soportlo del RociJctor

AP26\$BOAL*
OP26880WH
1\$;1! 1ll;- Spray H.,11d1Cob11zs de/ Raciador

RP17786 (White/Blanco)
RP17116AL*
Spray & Hose Assembly
Enssmbf(l dBl a M<Jngusra y Radadar
RP6015WA. (Almotir;t/Afrn9tldf8)
PGD!SWW (White/Blanco)
Support Asctnbly
Soporte eel RociuJor

RP194
Wrench-H1Jndla/
Adjusting Ring
Liave-ManUal
Anillo dQ Ajusttl

RP3614
Repair Kit
Hertamfentas paflf.
Rsparac:iOms



ilf ift/ #if"ffffVJ;!"

Laundry Faucet

19-01 TUE 12:08 PM

WSC HARRISSBURG

1111J.LO,...

Q LJI!.. !& 1>

- laundry faucets
- install on
- 4" Centerset
- 55/8" Long, 6 1/2" high spout swings 360°
- Blade handles
- Standard with 1/2" P.S. shanks
- 1/4" Trap seal primer plug *



W

• VANDAIR (SISTANT ACUUM GRAKER) FOR USE WITH MODEL 2131

ADA

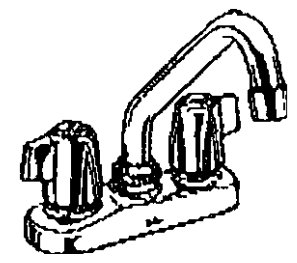

• INCLUDES STRAIGHT TEMPERATURE CONTROL HOSE THRU

FINISH	Chrome	Chrom.o.	chrome
MODEL NO.	2131	ftP/.5695	2133
PRICE	51.90	23.96	51.9
CASE QUANTITY	6	1	6

* Plug can be removed to attach a hose which will enable floor drain trap to be refilled everytime faucet is used.

Cdij!! COMPONENT VALVES

FOR LAVATORY, CLOSET AND SINK SUPPLIES

use Brass Craft 26 276A

Eastern

---. IPRESSION STOPS FOR 3a" AND 1/2" O.D. TUBE

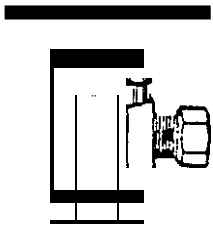

Iron Pipe Inlet

CATALOG NO.	DESCRIPTION	WEIGHT Per 100	●●●UST EACH	
			\$... ..	CP
44C	V" O.D. x V" I.P.T. Angle Stop	32 tbs.		
63C	% O.D. x 3/e" 1.P.T. Angle Stop	32 tbs.		
64C	% O.D. x V" 1.P.T. Angle Stop	32 tbs.		
74C	1/15" O.D. x V" I.P.T. Angle Stop	32 lbs.		
83C	7/8" O.D. x %" 1.P.T. Angle Stop	33 lbs.		
84C	V" O.D. x V" 1.P.T. Angle Stop	33 lbs.		

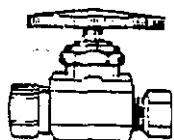

Iron Pipe Inlet

63CS	% O.D. x %" 1.P.T. Strt. Stop	38 lbs.
64CS	% O.D. x V" I.P.T. Strt. Stop	36 lbs.
83CS	V" O.D. x %" 1.P.T. Strt. Stop	39 lbs.
84CS	V" O.D. x V" I.P.T. Strt. Stop	36 lbs.

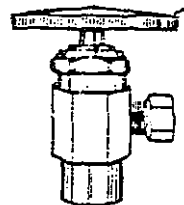

Sweat Inlet

R19 SWC-60	1/8" O.D. x V" Norn. Angle Stop	33 lbs.
SWC-68	3/e" O.D. x %" Norn. Angle Stop	33 lbs.
SWC-70	As" O.D. x V" Norn. Angle Stop	33 lbs.
SWC-80	V" O.D. x V" Norn. Angle Stop	33 lbs.
SWC-88	V" O.D. x 1/4" Norn. Angle Stop	33 lbs.



Sweat Inlet

SWC-60S	% O.D. x V" Norn. Strt. Stop	35 lbs.
SWC-BOS	V" O.D. x V" Norn. Strt. Stop	37 lbs.

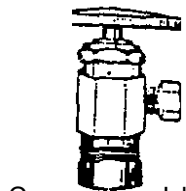

Compression Inlet

C40	% O.D. x 1/2" Norn. Angle Stop	36 lbs.
C60	3/e" O.D. x V" Norn. Angle Stop	36 lbs.
C70	7/15" O.D. x 1/2" Norn. Angle Stop	37 lbs.
CSO	1/2" O.D. x 1/2" Norn. Angle Stop	37 lbs.



Compression Inlet

C6DS,	3/e" O.D. x 1/2" Norn. Strt. Stop	45 lbs.
CSOS	1/2" O.D. x 1/2" Norn. Strt. Stop	38 lbs.
C66S	7/8" O.D. x 3/e" O.D. Comp. Strt. Stop	36 lbs.

Component valves are individually boxed, 6 per package, 72 per master carton.

db Dearborn™
Brass

Specifications

DESCRIPTION

- P-trap, 1-1/4" - 17 gauge.
- Includes: (1) low pattern steel flange, (1) regular quarter bend, (1) regular short "J", (2) J.D. rubber washers. (2) zinc die cast nuts.
- Chrome-plated,

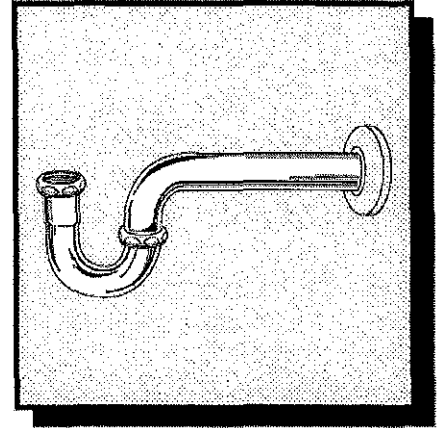

P-TRAP
701-1

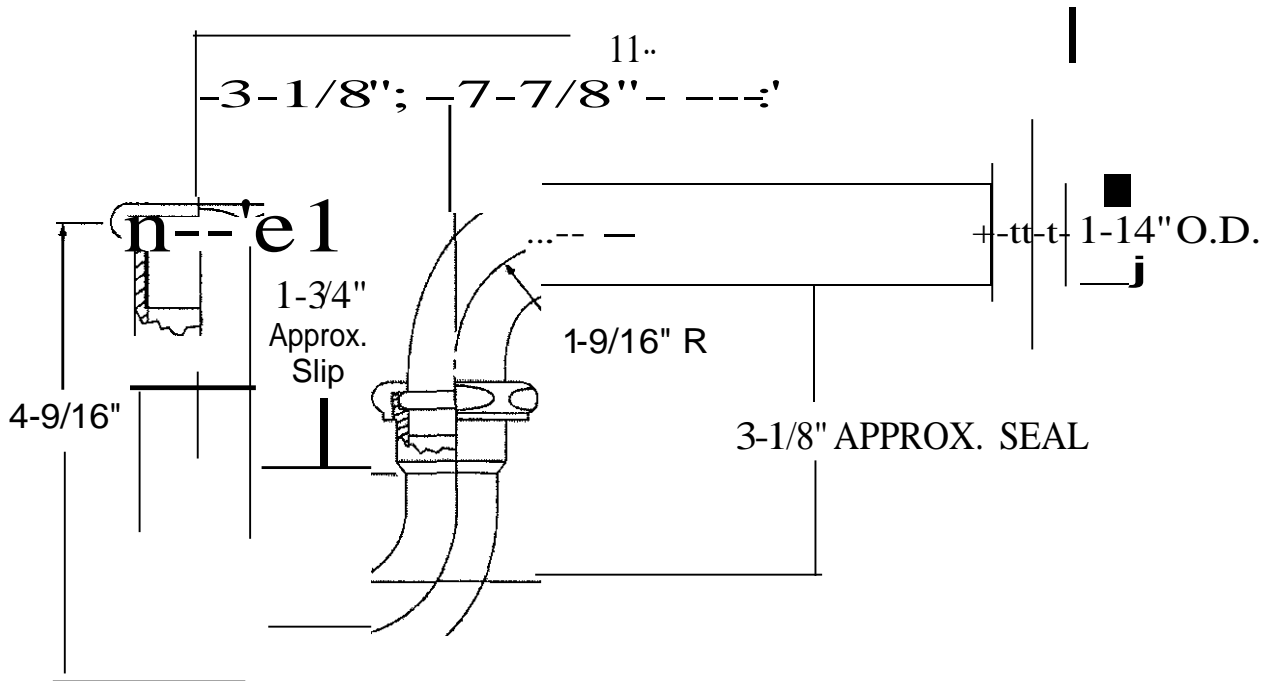

DESCRIPTION

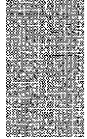

- P-trap, 1-1/2" - 17 gauge,
- Includes: (1) regular pattern steel flange, (1) regular quarter bend, (1) regular short "J", (2) rubber union washers, (2) zinc die cast nuts,
- Chrome-plated,

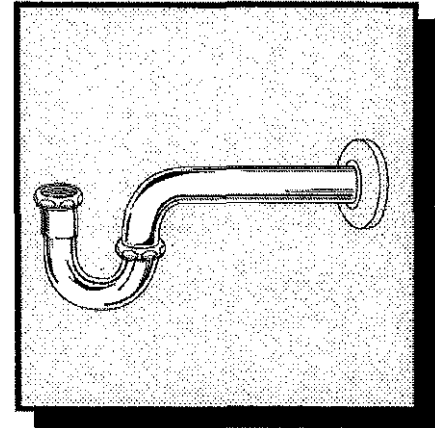

P-TRAP
704-1

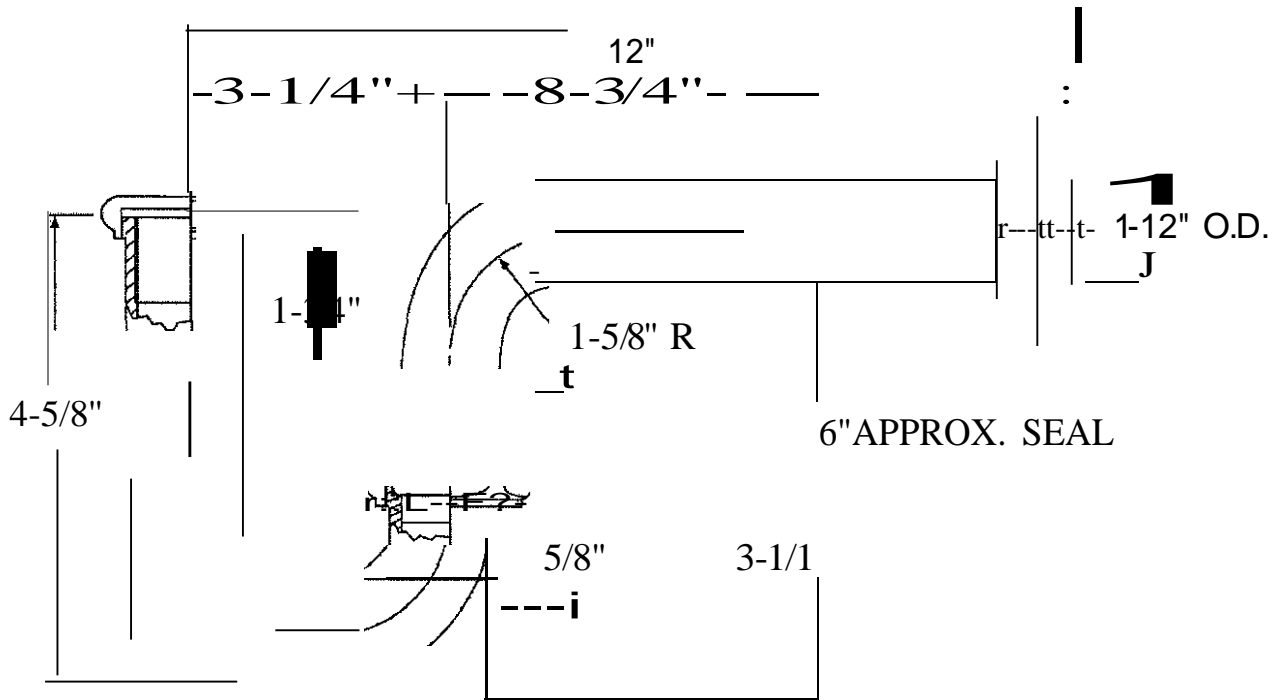

PRODUCT INFORMATION SHEET

K

RECEIVED

~~THE KEENEY MANUFACTURING COMPANY~~

SEMI-CAST TRAP

5303PC

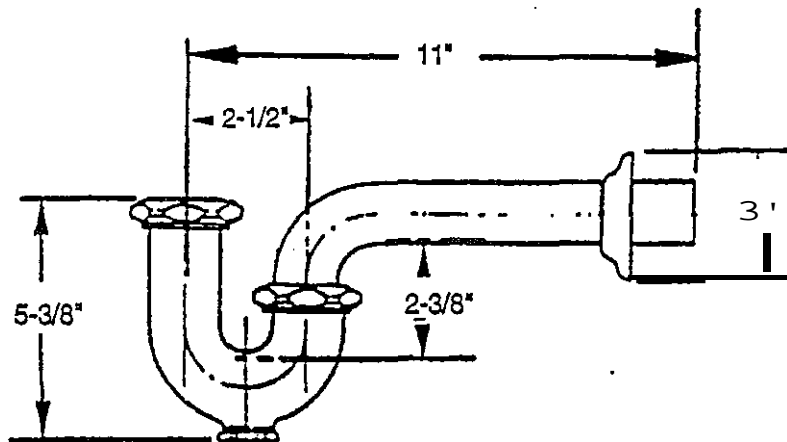

FEATURES:

- 1-1/4¹¹ x 1-1/4¹¹
- 17 Gauge
- With Cleanout
- Polished Chrome
- Brass-Nuts



WASTE ARMS - SINK TAILPIECES

PartNum.	Item Description	UPCI 046224 +	Ctn Qty	Ctrl Ylt	UeM
WASTE ARMS DIRECT CONNECT {112* .CONTINUED					
542ARB	7" 17GA ROUGH BRASS - BULK PACKED	933236	25	13 lbs.	
542ASN	7" 17GA SATIN - BULK PACKED	933250	25	13 lbs.	
543ARB	9 1/2" 17GA ROUGH BRASS - BULK PACKED	723905	25	15 lbs.	
543ASN	9 1/2" 17GA SATIN - BULK PACKED	933304	25	15 lbs.	
544ARB	11 1/2" 17GA ROUGH BRASS - BULK PACKED	933373	25	18 lbs.	
544ASN	11 1/2" 17GA SATIN - BULK PACKED	933380	25	18 lbs.	
546ARB	15" 17GA ROUGH BRASS - BULK PACKED	933441	25	20 lbs.	
546ASN	15" 17GA SATIN - BULK PACKED	933472	25	20 lbs.	
547ARB	20" 17GA ROUGH BRASS - BULK PACKED	711773	25	25 lbs.	
547ASN	20" 17GA SATIN - BULK PACKED	933625	25	25 lbs.	
548ARB	24" 17GA ROUGH BRASS BULK PACKED	933687	25	33 lbs.	
548ASN	24" 17GA SATIN - BULK PACKED	933700	25	33 lbs.	

SINK TAILPIECES 1 1/4"

160PC	4" 22GA CHROME	92099 1	24	2 lbs.	
161PC	6" 22GA CHROME	92100 4	24	3 lbs.	
162PC	8" 22GA CHROME	92103 5	24	4 lbs.	
118PC	12" 22GA CHROME	72391 2	24	7 lbs.	

SINK TAILPIECES 1 1/2"

110RB	4" 22GA ROUGH BRASS	91799 1	48	6 lbs.	
110PC	4" 22GA CHROME	91796 0	48	6 lbs.	
111RB	6" 22GA ROUGH BRASS	91806 6	24	5 lbs.	
111PC	6" 22GA CHROME	91803 5	24	5 lbs.	
112RB	8" 22GA ROUGH BRASS	91812 7	24	6 lbs.	
112PC	8" 22GA CHROME	91808 0	24	6 lbs.	
113RB	10" 22GA ROUGH BRASS	91821 9	24	8 lbs.	
113PC	10" 22GA CHROME	91819 6	24	8 lbs.	
114RB	12" 22GA ROUGH BRASS	91826 4	24	9 lbs.	
114PC	12" 22GA CHROME	91822 6	24	9 lbs.	
120RB	18" 22GA ROUGH BRASS	91878 3	24	14 lbs.	
120PC	18" 22GA CHROME	91877 6	24	14 lbs.	
130PC	24" 22GA CHROME	92002 1	24	17 lbs.	
210RB	4" 20GA ROUGH BRASS	92292 6	48	9 lbs.	
V10PC	4" 20GA CHROME	2289 6	48	9 lbs.	
211RB	6" 20GA CHROME		24	6 lbs.	
211PC	6" 20GA CHROME	92294 0	24	6 lbs.	
212RB	8" 20GA ROUGH BRASS	92302 2	24	9 lbs.	
212PC	8" 20GA CHROME	92300 8	24	9 lbs.	
214RB	12" 20GA ROUGH BRASS	92312 1	24	13 lbs.	
214PC	12" 20GA CHROME	92309 1	24	13 lbs.	
220RB	18" 20GA ROUGH BRASS	92322 0	24	20 lbs.	
220PC	18" 20GA CHROME	92320 6	24	20 lbs.	

Features

- 12" (30.5 cm) rough-in
- Round front
- 1.6 gpf (6 /pf)
- **Ingenium™ flushing system**
- Combination toilet
- Includes polished chrome trip lever
- Less seat and supply
- With Insuliner® insulated tank lining (-U)
- With tank cover locks (-T)
- Z' (5.1 cm) glazed trapway
- 10-1/2" (26.7 cm) x 8-7/8" (22.5 cm) water area
- With right-hand trip lever (-RA)
- With bedpan lugs (-L)
- With Insuliner® insulated tank lining

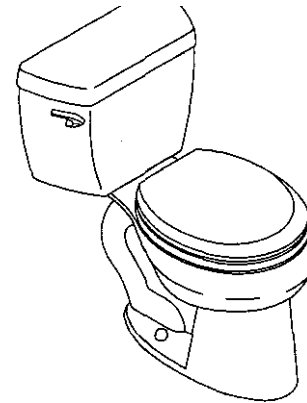

Codes/Standards Applicable

Specified model meets or exceeds the following:

- ASME A112.19.6
- ASME A 112.19.2
- Energy Policy Act of 1992 (EPACT)
- IAPMO/IUPC
- CSA 845

Colors/Finishes

- 0: White
- Other: Refer to Price Book for additional colors/finishes

Accessories:

- 0: White
- CP: Polished Chrome
- PB: Polished Brass
- Other: Refer to Price Book for additional colors/finishes

Specified Model

Model	Description	Colors/Finishes	
K-3423	Round front bowl toilet (left-hand trip lever)	O 0 White	D Other
K-3423-T	Toilet with tank cover locks (left-hand trip lever)	O 0 White	D Other
K-3423-U	Toilet with Insuliner tank (left-hand trip lever)	O 0 White	D Other
K-3423-UT	Toilet with Insuliner tank & tank cover locks (LH trip lever)	O 0 White	O Other
K-4277-L & K-4620	Toilet with bed pan lugs (left-hand trip lever)	D 0 White	D Other
K-3423-RA	Round front bowl toilet (right-hand trip lever)	O 0 White	D Other
K-3423-TR	Toilet with tank cover locks (right-hand trip lever)	O 0 White	D Other
K-3423-UR	Toilet with Insuliner tank (right-hand trip lever)	O 0 White	D Other
K-4277-L & K-4620-RA	Toilet with bed pan lugs (right-hand trip lever)	O 0 White	O Other_____

Product Specification:

The round front combination elongated toilet compact toilet shall be 12" (30.5 cm) rough-in. Toilet shall be made of vitreous china. Toilet shall have 10-1/2" (26.7 cm) x 8-7/8" (22.5 cm) water area. Toilet shall be 1.6 gpf (6 lpf) with Ingenium™ flushing system. Toilet shall have a 2" (5.1 cm) glazed trapway. Toilet shall include polished chrome trip lever. Toilet shall be less seat and supply. Toilet shall have right-hand trip lever. Toilet shall have bed pan lugs (-L). Toilet shall have Insuliner® insulated tank lining (-U). Toilet shall have tank cover locks (-T). Toilet shall be Kohler Model K-3423-_____

WELLWORTH™

Recommended Accessories			
K-4658	Breviar™ seat with cover	<input type="checkbox"/> White	<input type="checkbox"/> Other
K-4663	French Curven seat with cover	<input type="checkbox"/> White	<input type="checkbox"/> Other
K-4686	Primary™ open front seat	<input type="checkbox"/> White	<input type="checkbox"/> Other
K-7637	Angle supply with stop	<input type="checkbox"/> GP	<input type="checkbox"/> PS <input type="checkbox"/> Other _____
Optional Accessories			
K-9404-L	Trip lever, left-hand (non-GP)	<input type="checkbox"/> PS	<input type="checkbox"/> Other
K-9404-R	Trip lever, right-hand (non-GP)	<input type="checkbox"/> PB	<input type="checkbox"/> Other _____

Installation Notes

Install this product according to the installation guide.

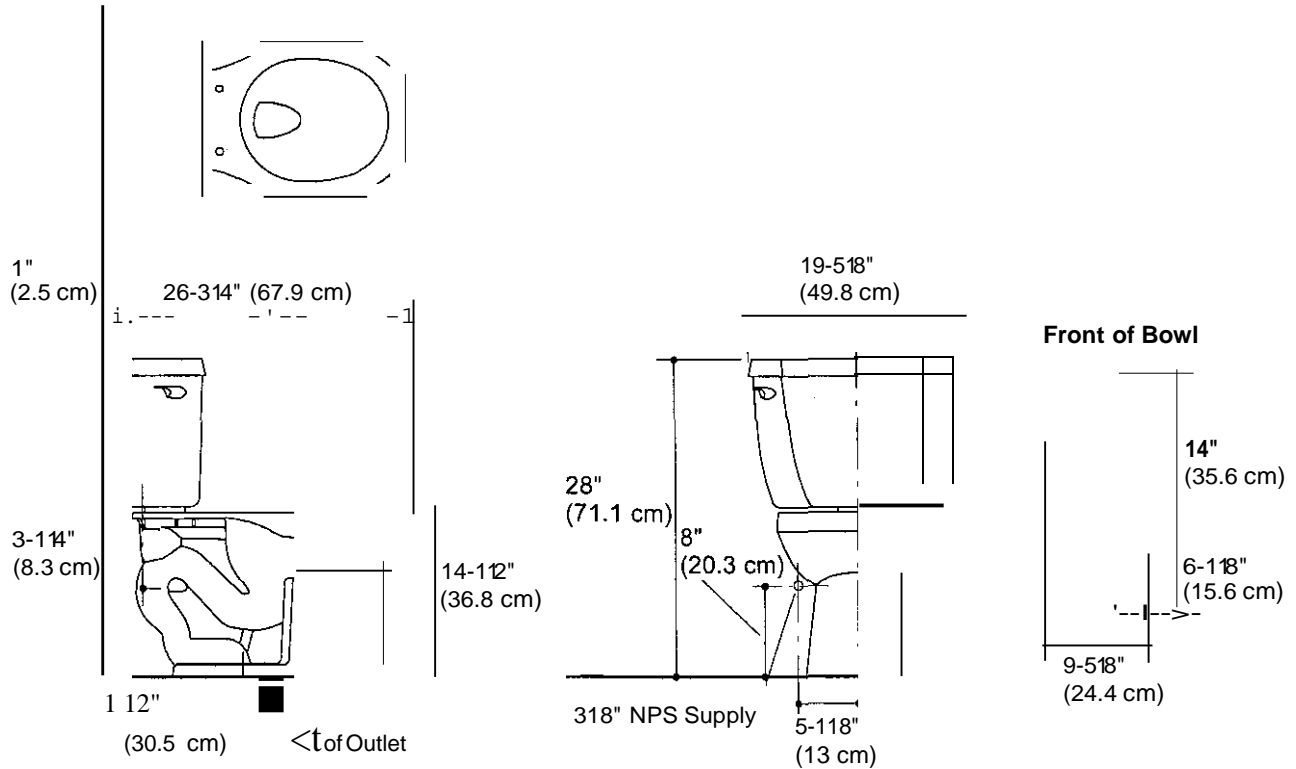

Product Diagram

KOHLER.

HIGHLINE

TOILET

K-3427

| ADA |

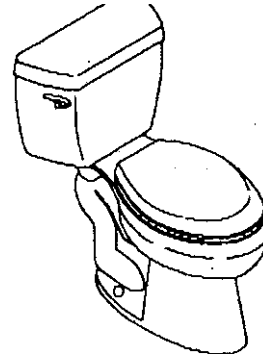

HANDICAP
BASE

FEATURES

- Gravity flush
- 12" rough-in
- Vitreous china
- Elongated bowl
- 1.6gpf
- Includes polished chrome trip lever
- Combination toilet
- 16-1/2" high bowl is ADA compliant
- 2-glazed trapway
- Less seat and supply
- With right-hand trip lever (-RAJ)
- With bidpan lugs (-L)
- With Insuliner, insulated tank lining (-U)
- With tank cover locks (-T)

CODES/STANDARDS APPLICABLE

Specified model meets or exceeds the following:

- ADA
- ASME/ANSI A 112.19.2M
- ASME/ANSI A 112.19.6M
- CASO/ANSI A 117.1
- Energy Policy Act of 1992 (EPACTJ)
- Canadian Standards Association (CSA)
- IAPMO/IPC
- States of Massachusetts, New York, & Texas
- City of Los Angeles, CA

COLORS/FINISHES

- D White
 - Other Refer to Fixtures Price Book for additional colors
- Accessories:
- O White
 - CP Polished Chrome
 - PB Polished Brass
 - Other Refer to Fixtures Price Book for additional colors

SPECIFIED MODEL:

Model	Description	Color/Finish	
K-3427	Elongated bowl toilet	DO White	DOiher
K-3427-T	Toilet with tank cover locks	DO White	DOiher
K-3427-U	Toilet with Insuliner tank	DO WMe	DO!her
K-3427-UT	Toilet with tank cover locks and insuliner tank	DO White	DOther
K-4274-L & K-4620	Toilet with bid pan lugs (left-hand trip lever)	DO White	OO!her
K-3427-RA	Elongated bowl toilet (right-hand trip lever)	DO White	DQ!her
K-3427-TR	Toilet with tank cover locks (right-hand trip lever)	DO White	DQ!her
K-3427-UR	Toilet with Insuliner tank (right-hand trip lever)	DO White	DOiher
K-4274-L & K-462G-RA	Toilet with bid pan lugs (right-hand trip lever)	DO White	OOiher
Recommended Accessories			
K-4852	Lustra seat with cover	DO White	OO!her
K-4652-A	Lustra seat with cover (includes anti-microbial agent)	DO White	

More Recommended & Optional Accessories on Page 2

PRODUCT SPECIFICATION:

The elongated combination toilet shall be 12" rough in. Toilet shall be made of vitreous china. Toilet shall be 1.6 gpf; Toilet shall include polished chrome trip lever. Toilet shall be ADA compliant with 16-1/2" high bowl. Toilet shall have 2" glazed trapway. Toilet shall be less seat and supply. Toilet shall have right-hand trip lever (-RA). Toilet shall have Insuliner insulated tank lining (-U). Toilet shall have tank cover locks. Toilet shall be Kohler Model K-3427-

We reserve the right to make revisions without notice in the design of fixtures or in packaging unless this right has been waived at the time the order is accepted.

HIGHLINE.

Recommended Accessories (cont.)			
K-4650	Lustre - open front seat	00 White	Other: _____
K-4670--C	Lustre - open front seat	00 White	Other: _____
K-7637	Angle supply with stop	DCP IDPB	Other: _____
Optional Accessories			
K-9404-L	Trip lever (non CP)	DPB	Other: _____

PRODUCT INFORMATION

Fixture;	
Configuration	2-piece, elongated
Gallons per flush	1.6
Passageway	2 -
Water depth from rim	6"
Seat post hole centers	5-1/2"
Included Components:	
Bowl	K-4274
Tank	K-4620
Tank cover	64635
Trip lever	K-9404

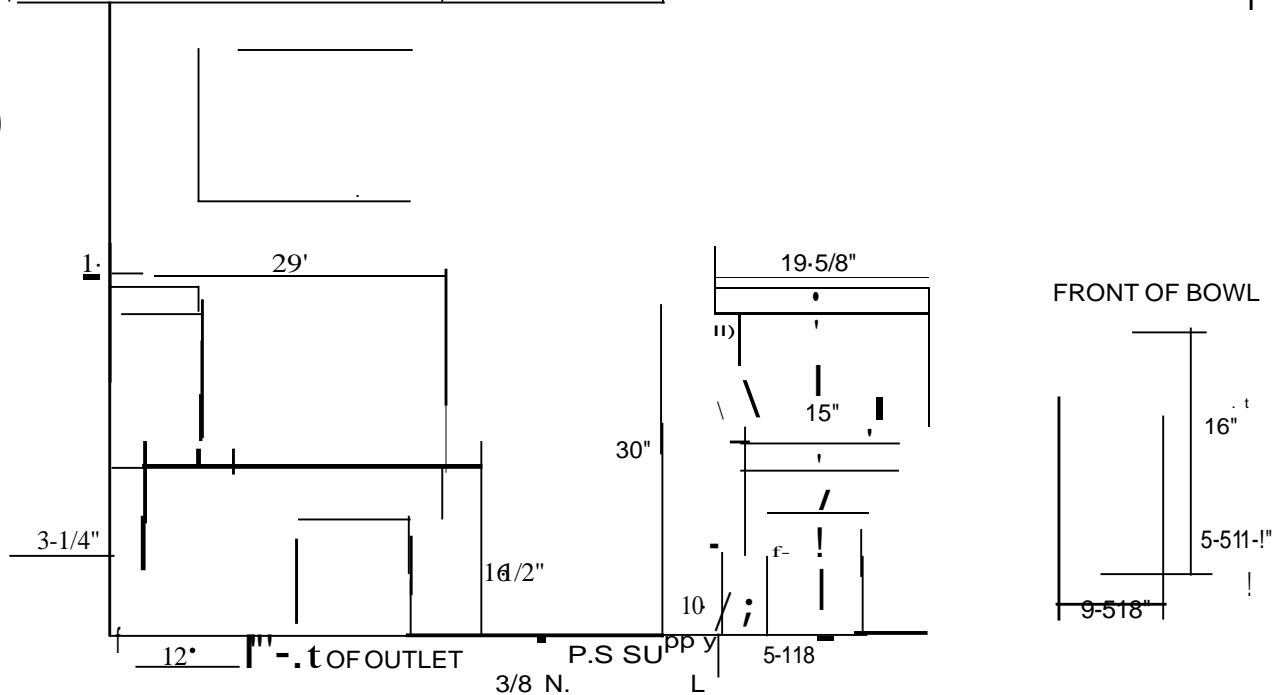

PRODUCT DIAGRAM

MADERA™ ELONGATED 10" ROUGH

- Vitreous china
- Low-consumption (6.0 Lpf/1.6 gpf)
- 10" roughing-in
- Elongated bowl
- Direct-fed siphon jet action
- Fully glazed 2" ballpass trapway
- 11" x 13" water surface area
- 1-1/2" top spud
- 2 bolt caps
- 100% factory flush tested

- 2234.015 Top spud
- 2234.137 Top spud with slotted rim for bedpan holding (white only)

Nominal Dimensions:
768 x 381 x 359mm
(30-1/4" x 15" x 14-1/8")

Recommended working pressure'-between
25 psi at valve when flushing and 80 psi
static

Fixture only, less seat

Compliance Certifications -
Meets or Exceeds the Following Specifications:
• ASME A112.19.2M (and 19.5M) for Vitreous

China Fixtures - includes Flush Performance,
Ball Pass Diameter, Trap Seal Depth and
all Dimensions

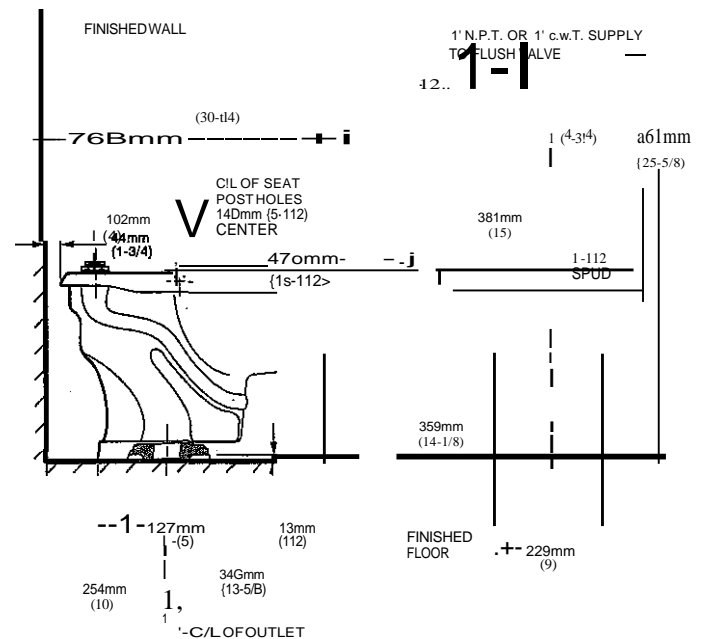
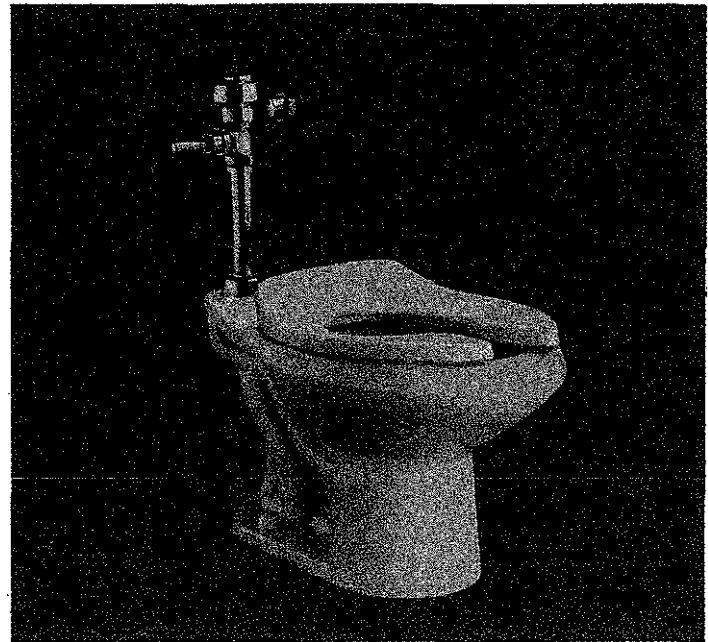

NOTES:
PRODUCT 2234.015 SHOWN, 2234.137 SAME AS EXCEPT WITH SLOTTED RIM FOR BED PAN HOLDING.
TO COMPLY WITH AREA CODE GOVERNING THE HEIGHT OF VACUUM BREAKER ON FLUSH VALVE, THE PLUMBER MUST VERIFY DIMENSIONS SHOWN FOR SUPPLY ROUGHING.
FLUSH VALVE NOT INCLUDED AND MUST BE ORDERED SEPARATELY.
THIS TOILET IS DESIGNED TO ROUGH-IN AT A MINIMUM DIMENSION OF 254MM (10") FROM FINISHED WALL TO C/L OF OUTLET.
IMPORTANT: Dimensions of fixtures are nominal and may vary within the range of tolerances established by ANSI Standard A112.19.2.
These measurements are subject to change or cancellation. No responsibility is assumed for use of superseded or voided pages.

- To Be Specified
- Color: White Bone Silver Black Shell
 - Seat: Olsonite #95 open front seat less cover
 - Seat: Church #9500C open front seat less cover
 - Alternate Seat:
 - Flush Valve: Sloan Royal #111
 - Alternate Flush Valve:

Features

- o Vitreous china
- Elongated bowl
- 1.6gpf (6/lpf)
- Z' (5.1 cm) glazed trapway
- Ingenium™ flushing system
- Combination toilet
- Includes polished chrome trip lever
- Less seat and supply
- With Insuliner® insulated tank lining (-U)
- With tank cover locks (-T)
- With right-hand trip lever (-RA)
- o With bidpan lugs (-L)

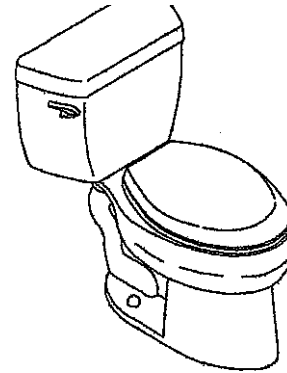

Codes/Standards Applicable

Specified model meets or exceeds the following:

- ASME A 12.19.6
- ASME A 12.19.2
- Energy Policy Act of 1992 (EPACT)
- IAPMO/IUPC
- CSA B45

Colors/Finishes

- O: White
- Other: Refer to Price Book for additional colors/finishes

Accessories:

- O: White
- GP: Polished Chrome
- PB: Polished Brass
- Other: Refer to Price Book for additional colors/finishes

Specified Model

Model	Description	Colors/Finishes	
K-3422	Elongated bowl toilet (left-hand trip lever)	O O White	O Other
K-3422-T	Toilet with tank cover locks (left-hand trip lever)	O O White	O Other _____
K-3422-U	Toilet with Insuliner tank (left-hand trip lever)	O O White	O Other
K-3422-UT	Toilet with Insuliner tank and tank cover locks (LH trip lever)	O O White	O Other
K-4276-L & K-4620	Toilet with bid pan lugs (left-hand trip lever)	O O White	O Other _____
K3422-RA	Elongated bowl toilet (right-hand trip lever)	O O White	O Other
K3422-TR	Toilet with tank cover locks (right-hand trip lever)	O O White	O Other
K3422-UR	Toilet with Insuliner tank (right-hand trip lever)	O O White	O Other
K-4276-L & K-4620-RA	Toilet with bid pan lugs (right-hand trip lever)	O O White	O Other _____
Recommended Accessories and Optional Accessories on Page 2			

Product Specification:

The elongated combination toilet shall be made of vitreous china. Toilet shall be 1.6gpf (6 lpf) with Ingenium™ flushing system. Toilet shall have 2" (5.1 cm) glazed trapway. Toilet shall include polished chrome trip lever. Toilet shall be less seat and supply. Toilet shall have right-hand trip lever (-RA). Toilet shall have bid pan lugs (-L). Toilet shall have Insuliner™ insulated tank lining (-I). Toilet shall have cover locks (-T). Toilet shall be Kohler Model K-3422-_____.

WELLWORTH

Recommended Accessories			
K-4664	Brevia™ seat with cover	<input type="radio"/> White	<input type="radio"/> Other
K-4653	French Curven... closed seat front	<input type="radio"/> White	<input type="radio"/> Other
K-7637	Angle supply with stop	<input type="radio"/> CP	<input type="radio"/> PB
Optional Accessories			
K-9404-L	Trip lever, left-hand (non-CPI)	<input type="radio"/> PB	<input type="radio"/> Other
K-9404-R	Trip lever, right-hand (non-CP)	<input type="radio"/> PB	<input type="radio"/> Other

Installation Notes

Install this product according to the installation guide.

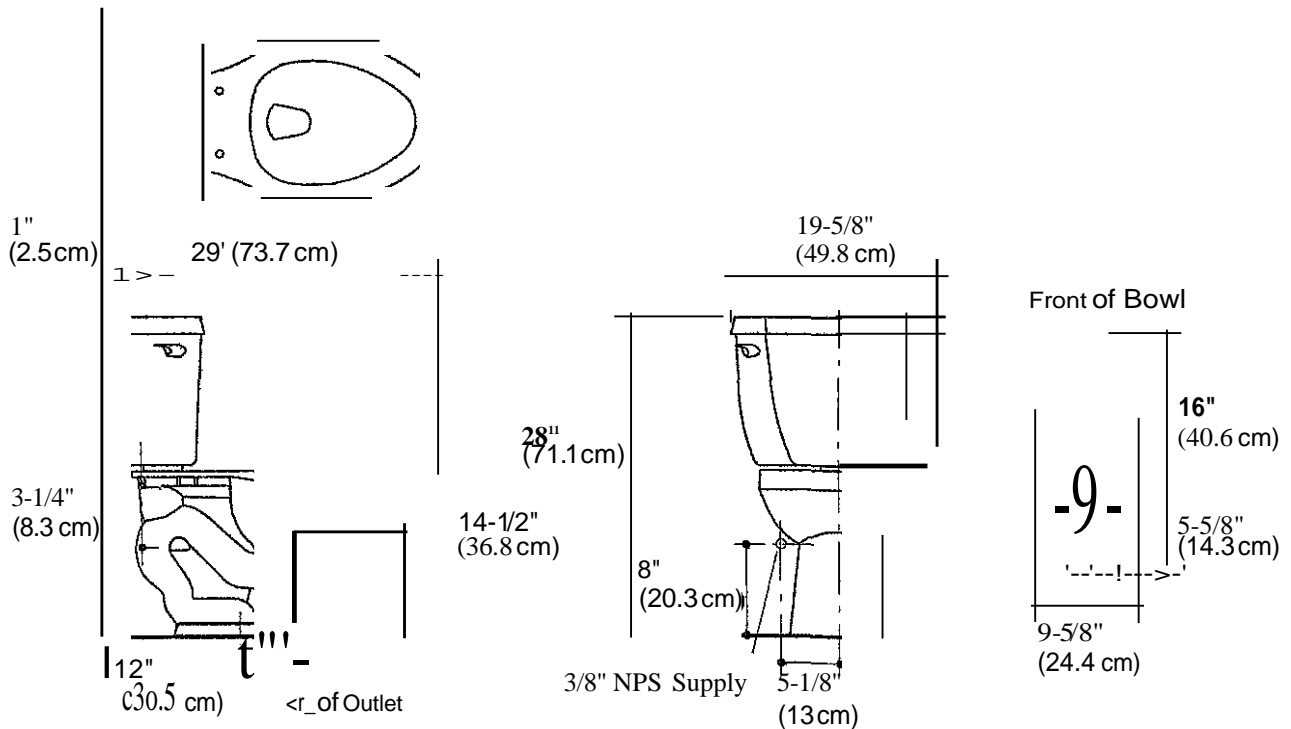

Product

Diagram

WELLWORTH TOILET
Page 2 of 2
114904-4-AE

THE BOWL LOOK
OF KOHLER

KOHLER®

WELLWORTH COMFORT HEIGHT

TOILET

K-3481
) ADA)

FEATURES

- Concealed trapway
- Ingenium™ flushing system
- 1.6gpf (6L) performance comparable to 3.5gpf (13L) models
- 12" (30.5cm) rough-in
- Vitreous china
- 10-1/2" (26.1cm) x 9-1/4" (23.5cm) water area
- Elongated bowl
- Comfort height
- Includes polished chrome trip lever
- Combination toilet
- 16-1/2" (41.9cm) high bowls ADA compliant
- Less seat and supply
- With Insuliner® insulated tank lining (U)



CODES/STANDARDS APPLICABLE

Specified model meets or exceeds the following:

- ADA
- ◇ ASME/ANSI A112.19.2M
- CANSI A117.1
- Energy Policy Act of 1992 (EPACT)
- CSA
- IAPMO/UPC

COLORS/FINISHES

- 0 White
- Other Refer to Fixtures Price Book for additional colors

Accessories:

- 0 White
- CP Polished Chrome
- PB Polished Brass
- Other Refer to Fixtures Price Book for additional colors

SPECIFIED MODEL:

Model	Description	Colors/Finishes	
K-3481	Elongated bowl toilet	DO White	DOther
K-3481-U	Toilet with Insuliner tank	DO White	DOther
Recommended Accessories			
K-4652	Lustra™ seat with cover	DO White	DOther
K-4652-A	Lustra™ seat with cover (includes anti-microbial agent)	DO White	
K-4650	Lustra™ open front seat	DO White	DOther
K-4670.C	Lustra™ open front seat	DO White	DOther
K-7637	Angle supply With stop	DGP DPB	DOther
Optional Accessories			
K-9404-I.	Trip lever (non-GP)	DPB	DOther

PRODUCT SPECIFICATION:

The elongated combination toilet shall be 12" (30.5cm) rough-in. Toilet shall be made of vitreous china. Toilet shall have concealed trapway. Toilet shall have 10-1/2" (26.7cm) x 9-1/4" (23.5cm) water area. Toilets shall have Kohler Ingenium™ flushing system. Toilet shall be at comfort height Toilet shall be 1.6gpf (6L). Toilet shall include polished chrome trip lever. Toilet shall be ADA compliant with 16-1/2" (41.9cm) high bowl. Toilet shall be less seat and supply. Toilet shall have Insuliner® insulated tank lining (U). Toilet shall be Kohler Model K-3481.

WELLWORTH COMFORT HEIGHT™

PRODUCT INFORMATION

Fixture:	
Configuration	2-piece, elongated
Water per flush	1.6 gallons (6L)
Passageway	2-1/6" (5.4cm)
Water area	10-1/2" (26.7cm) x 9-1/4" (23.5cm)
Water depth from rim	5-1/2" (14cm)
Seat post hole centers	5-1/2" (14cm)
Included Components:	
Bowl	K-4276
Tank	K-4620
Tank cover	84591
Trip lever	K-9404

Fixture dimensions are nominal and conform to tolerances in ASME Standard A112.19.2M.

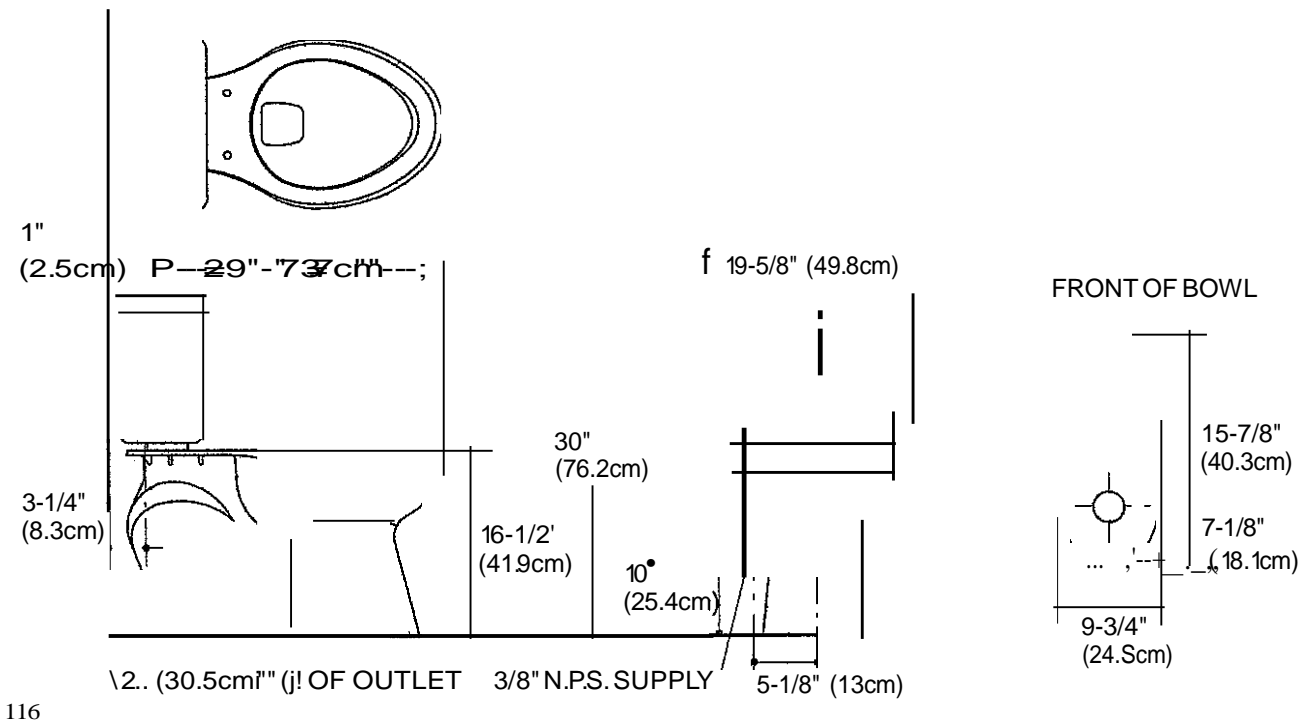

116

PRODUCT DIAGRAM

tMt S!Mttlaid |
BARRIER FREE

AFWALL™ t:LONGATE:D
...FLUSfl,VALVE TOILET
 VITREOUS CHINA

AFWALL™ ELONGATED TOILET

- Vitreous china
- Low-consumption (6.0 Lpf/1.6 gpf)
- Wall-mounted elongated bowl
- Fully glazed trapway
- Condensation channel
- Direct-fed siphon jet action
- 1-1/2" inlet spud
- 2" baflpass trapway
- 10" x 12" water surface area
- 100% factory flush tested

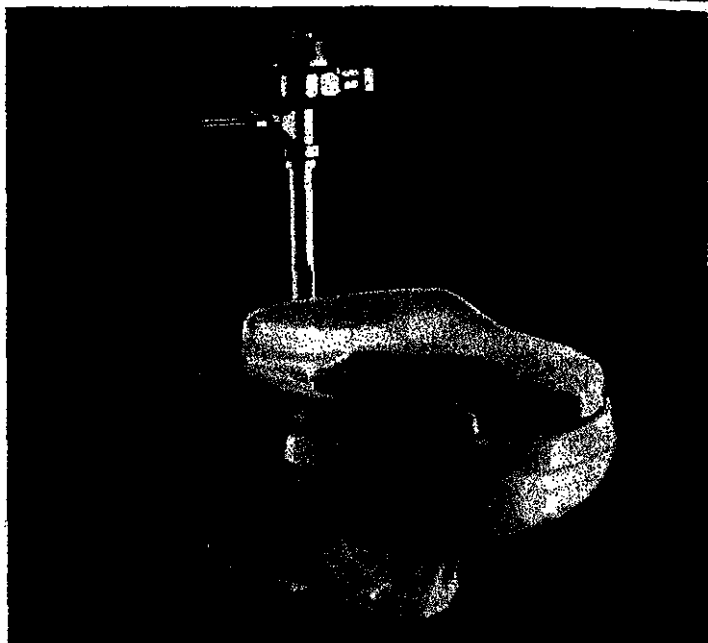

- 2257.03. +P u<leffi.c +; .!
- 2256.194 Top spud with slotted rim for bedpan holding (White only)
- 2258.125 Back spud .
- 2254.127 Back spud with slotted rim. for bedpan holding (White only)

Recommended working pressure--betWeen 30 pSi at valve when flushing and 80 psi static

Nominal Dimensions:
 635 x 375 x 381mm (25" x 14-3/4" x 15")

Fixture only, less seat and bolt caps

Compliance Certifications •
 Meets or Exceeds the Following Specifications:
 • ASME A112.19.2M (and 19.BM) for Vitreous China Fixtures - includes Flush Performance, Ball Pass Diameter, Trap Seal Depth and all.Dimensions

NOTE: Roughing-in information shown on reverse side of page

ToBeSpecified

- Color: White. Bone Silver 'o Shell Black
- Seat: Olsonlte #95 open front seat less cover
- Seat: Church #9500C open front seat less cover
- Alternate Seat:
- Flush Valve: Sloan Royal #111 (Top Spud)
 Sloan Royal #144-1.5 (Back Spud)
- Alternate Flush Valve:
- Carrier Fitting (by others):

•Wh n installed so top of seat is 432 to 483mm (17" to 19") from the finished floor.
 MEETS THE AMERICAN DISABILmEs ACT GUIDELINES AND ANSI A117.1 REQUIREMENTS FOR ACCESSIBLE AND USEABLE BUILDING FACILmES. CHECK LOCAL CODES.

. SPS 2254/2256/2257/2258

LJ11r e 1

roNTI't t/V f.Vt7r(LeO hJ.TEtC.

DESCRIPTION

PF8AM

SANDSTONE

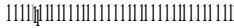

403606

MODEL

PF8AM



UPC



0 92026 13527 9

PROD

503027

S/N

0430571464



MADE IN CHINA BY OASIS CORPORATION

265 N. HAMILTON RD. COLUMBUS, OHIO 43213 U.S.A.



**CHLORINE, TASTE &
ODOR, and LEAD &
CYST REDUCTION**
033879-001

Service Life	1 Year / 1500 Gallons	(5670 Liters)
Maximum Flow	.50 GPM	(1.9 LPM)
Maximum Pressure	125 PSIG	(8.6 bar)
Maximum Temperature	100 F	(38 C)
Minimum Temperature	35 F	(2 C)

NOTES:

- ✓ Do not use where water is microbiologically unsafe or of unknown quality without adequate disinfection before or after unit.
 - ✓ Install in cold water applications only.
- A. Unscrew old cartridge from head.
 - B. Screw in new cartridge until lightly seated. **DO NOT** overtighten.
 - C. Check for leaks. If leaks occur, repeat Steps 1 through 3. If leaks persist, discontinue use and call your supporting dealer.
 - D. Flush 4 gallons of water through filter before use.
 - E. Install and dispose of in compliance with local and state regulations.

FILTER

Oasis® and  are Registered Trademarks of Oasis Corporation.

OASIS Corporation
265 North Hamilton Road
Columbus, Ohio 43213
800.64.OASIS (800.646.2747)
OasisWaterCoolers.com

Dayton" Double Bowl
Models D-23321 and D-23322

DAYTON

SPECIFICATIONS

GENERAL

Sink bowls are seamlessly drawn of #22 gauge nickel-bearing stainless steel.

DESIGN FEATURES

Bowl Depths: 6-1/2".

Coved Corners: Interior vertical and horizontal corners are rounded to a minimum of 2-3/4" radii.

Faucet Deck: Raised.

Finish: Exposed surfaces are polished to a satin finish with highshine bowl radius.

Underside: As described below.

Self-rimming: Sink is furnished with appropriate number of clamps to provide a secure, watertight installation.

OTHER

Drain opening: 3-1/2".

Faucet Holes: 3 or 4 holes as indicated, 4N center to center.

Note: Unless otherwise specified, sink is furnished with 4 faucet holes as shown.

ANSI Standard 112.19.3M compliant.

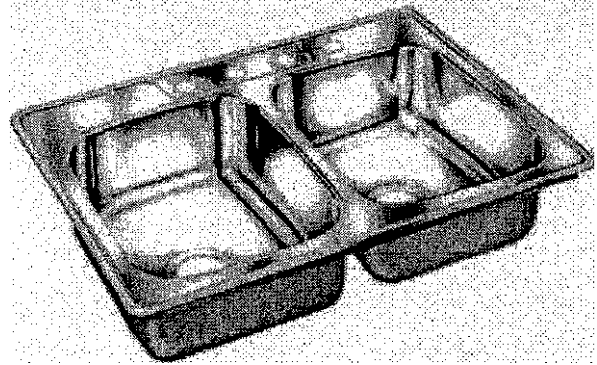

Model 0-23322-4 Shown

Model	0-11	In&ldt Bowl	Flange With	Cutout In Countertop	Number of Fuel Openings	Ship. Wt.
0-23321	33 21 1/2	14 15 1/2	4 1/2	32 1/4	4	12 1/2
D-23322	33 22	14 15 1/2	4 1/2	32 1/4	3	12 1/2
06-221	33 21 1/2	14 15 1/2	4 1/2	32 1/4	3	66
06-2-3322	33 22	14 15 1/2	4 1/2	32 1/4	3	67
051-23321	J3 21 1/2	14 15 1/2	4 1/2	32 1/4	3	60S
050-23321	33 22	14 15 1/2	4 1/2	32 1/4	3	60S

6- Pre-sinks are filled with insulating material. Sink bowls are 50% deadened on bottom only. OW. Prebl sinks are nested 50 Sinks per shipping carton (11) 11. Sink bowls are 50% deadened on bottom only.

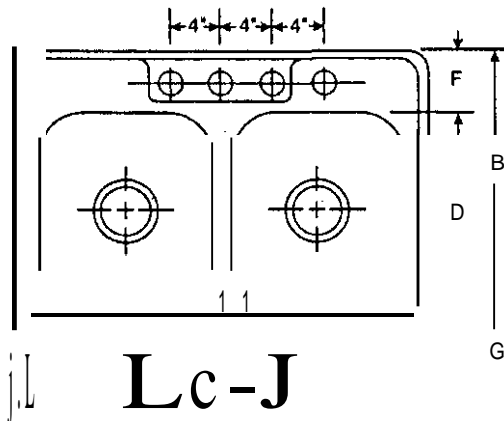

☉ = Equals Depth
Model D-23322-4 rns1 rated

ALL DIMENSIONS IN INCHES. TO CONVERT TO MILLIMETERS MULTIPLY BY 25.4.

In filing with our Policy of continuing product improvement, Elkay Manufacturing Company reserves the right to change product specifications without notice.

This specification describes an Elkay product with design, quality and functional benefits superior. When making a comparison of other products' offerings, be certain these features are not overlooked.

Elkay Manufacturing Company

www.elkay.com

2222 Camden Court
Oak Brook, IL 60523

Printed In U.S.A.
©1999 Elkay Mfg. Co.

(Rev. 1/99) 2-14C

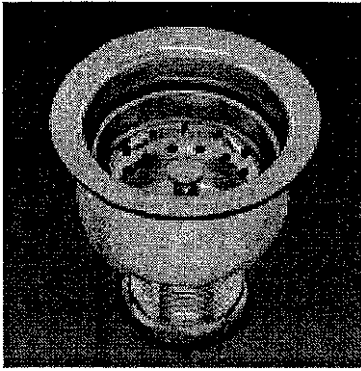

SNAP-n-LOC. MODEL SS-306

The most innovative basket strainer in history. The basket seals to the body through a ball bearing in the post creating a positive leakproof seal. Deep cup body and basket are 300 series stainless steel and both are buffed, creating a high polish finish. Hand knob and post are chrome plated brass and

the ball bearing is 300 series stainless steel. Zinc nuts are standard. Available with a brass tailnut (SS-306BTN) or brass tailnut and locknut (SS-3068). Fits 3 1/2" to 4" sink openings.

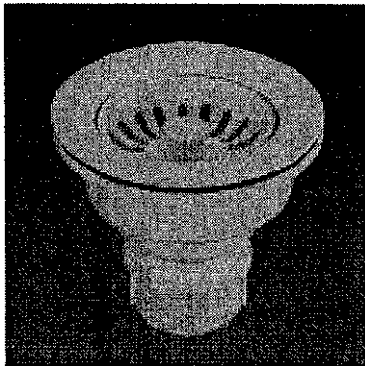
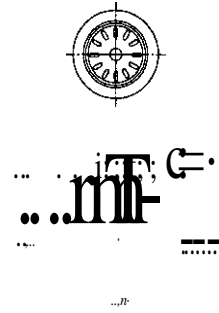

CELCON. SNAP-n-LDC. MODEL 307

Jomar's CELCON" SNAP-N-LOC BASKET STRAINER fits all 3 1/2" sink openings. It is dishwasher safe and is guaranteed not to crack, chip or fade.

Snap-N-Loc is easy to install. Available in 5 dynamic colors: White, Brite White, Bone, Biscuit and Linen.

Available in the 2nd Half of 2002.

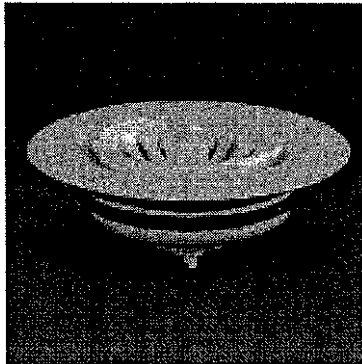
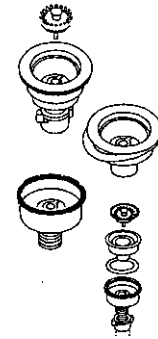

CELCON. FIT-ALL MODEL DS 311

Jomar's CELCON• FIT-ALUSINK DISPOSER STRAINER fits inside most existing disposers and strainer flanges. It is dishwasher safe and is guaranteed not to crack, chip or fade.

Available in 5 dynamic colors: White, Brite White, Bone, Biscuit and Linen.

Available in the 2nd Half of 2002.

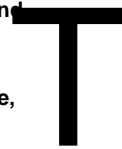

(@)	e	e
1305-WSHDF	1325-WSHDF	145-wstioF · J 1 6.1

Submitted Model No.: _____

Specific Features: _____

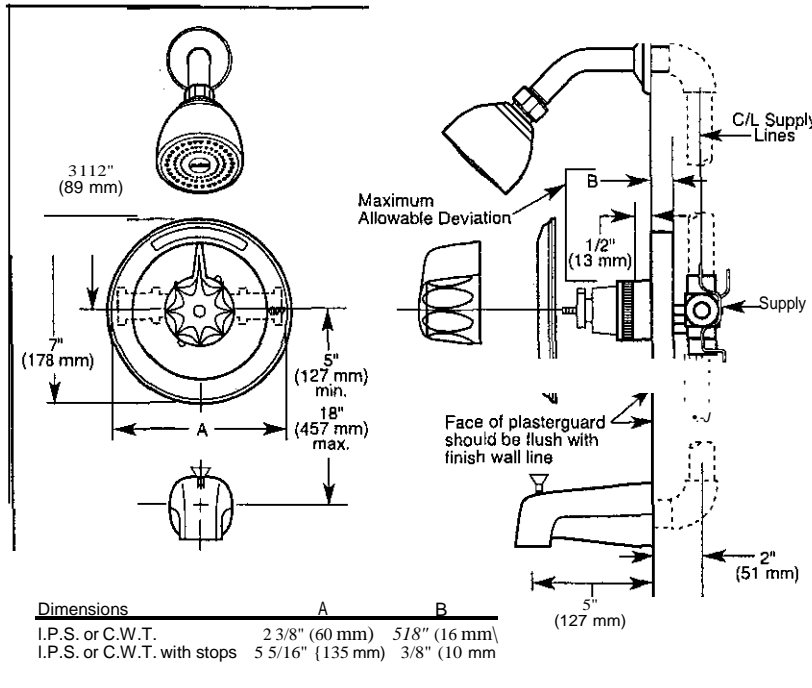

© DELTA.
COMMERCIAL

BATH MIXING VALVES

- Valve Only (1305 Series)
- Shower Only (1325 Series)
- Tub/Shower (1345 Series)
- Single Handle
- Monitor® with Scald-Guard® Valve
- Pressure Balance
- Temperature Only Controlled with Handle

C1) c@us

LISTED
UL Listed to US and Canadian
SBIB Standards D

COMPLIES WITH:

- ASME A112.18.1 (CSA 8125)

m indicates ADA compliance to LQ. CABO/ANSIAJ 17.1

- ASSE 1016
- IAPMO Listed
- CSA Certified
- City of L.A. approved

STANDARD SPECIFICATIONS:

- Pressure balanced single handle bath mixing valve.
- Requires 1 1/2" (38 mm) wall cavity.
- Back-to-back installation capability.
- Solid brass fabricated body.
- Vandal resistant blade handle.
- Monitor4D with ScaldGuard* valve. Valve accomplishes pressure balancing by using a stainless steel spool and sleeve in a replaceable cartridge. Cartridge utilizes integral check valves to prevent the cross flow of water within the valve. ScaldGuard* valve reduces the flow of water to .5 gpm / 1.9 L/min within 5 seconds of the complete loss of pressure in the cold water supply line. Outlet water temperature is maintained within +/- 3°F variation with changes in either hot or cold supply of up to 50 percent of the normal supply pressure.
- Temperature only controlled by handle with cold water always coming on first if cartridge is installed correctly.
- Field adjustable to limit handle rotation into hot water zone. Per ASSE 1016.
- 120° maximum handle rotation.
- Screwdriver stops.
- All parts shall be replaceable from front of valve.

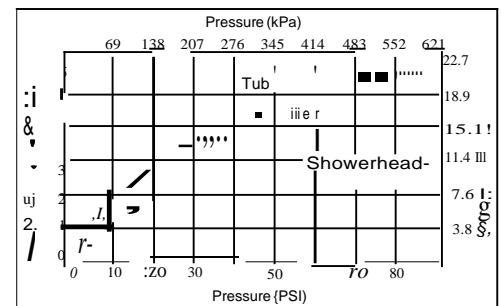

Standard Features	1	2	3	4	5	6
Washerless	●	●	●	●	+	●
Scald-Guard™ Valve	●	●	●	●	●	●
Back-to-Back Installation					●	●
1/2" LP.S. Inlets and Outlets	●	●	●	●	+	●
1/2" CW.T. Sweat Inlets and Outlets	●	●	●	●		●
Replaceable Cartridge	●	●	●	●	+	●
Adjustable Rotational Limit Stop	●	●	●	●	t	●
Vandal Resistant Metal Blade Handle	[;S;]	[;S;]	[;S;]			
Screwdriver Stops	●	●	●	●	●	●
Metal Shower Arm and Flange			●	●	●	●
Push-Clean™ Showerhead/1 Spray Pattern			●	●	●	●
Metal Tub Filler with Pull-Up Diverter					●	●
Chrome Finish	●	●	●	+	●	●

Available Options for Field Conversion:

- Cambridge Brass vandal resistant front mounting wall mount showerhead. Universal 1/2" FIP copper sweat inlet. Non-adjustable 30 spray angle from wall. 2.5 gpm @ 80 psi (9.5Umin @ 552 kPa). Cast brass with cast brass anchor plate. Chrome plated. Order 76262.
- Vandal resistant brass THE EMBRACER® showerhead - five spray patterns - 2.5 gpm @ 80 psi (9.5Umin @ 552 kPa). Chrome plated. Order RPW66HDF. See installation wrench below.
- Spanner Wrench for RPW66HOF. Order RP13498.
- Shower Arm. Order RP6023.
- Shower Flange. Order RP6025.
- Metallic tub filler with pull-down diverter for 1/2" C.W.T. or 1/2" I.P.S. Order RP17454.
- Non-metallic tub filler with pull-down diverter for 1/2" C.W.T. or 1/2" I.P.S. Order RP17453.
- Non-metallic slip-on tub filler with pull-down diverter for 1/2" C.W.T. Order RP5836.
- Metallic tub filler with pull-up diverter for 1/2" C.W.T. or 1/2" I.P.S. Order RP7533.
- Non-metallic tub filler with pull-up diverter for 1/2" C.W.T. or 1/2" I.P.S. Order RP5834.
- Non-metallic slip-on tub filler with pull-up diverter for 1/2" C.W.T. Order RP19820.
- Bath waste assemblies and bath accessories also available separately.

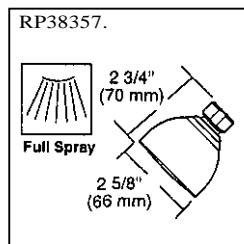
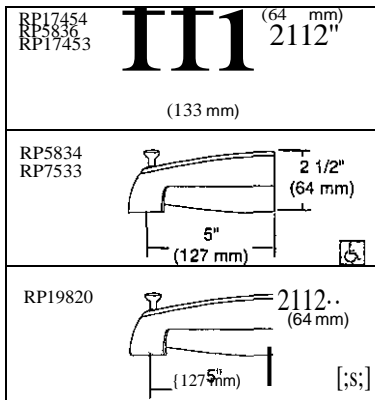

DELTA.
COMMERCIAL

Indianapolis, Indiana 46280
A Division of Masco Corporation of Indiana
© 2002 Masco Corporation of Indiana

DSP-1305-HDF Rev. B

DESCRIPTION

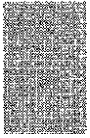

- End Outlet sink waste, 1-1/2" x 16" - 20 Gauge.
- Includes: (1) regular waste arm, (1) tailpiece, T.O.E. 1-1/2" x 3", (3) 1-1/2" die cast nuts, (3) 1-1/2" rubber washers, (1) 1-1/2" tee.
- Chrome-plated.

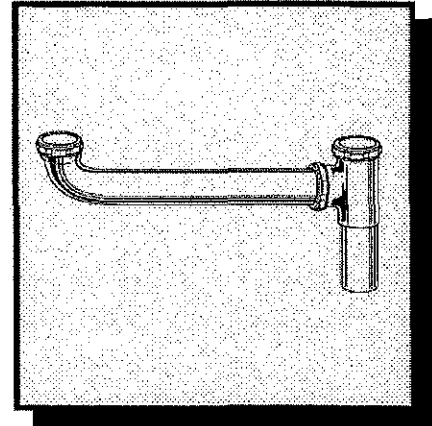

ENDOUTLET
SINK WASTE
108A-1

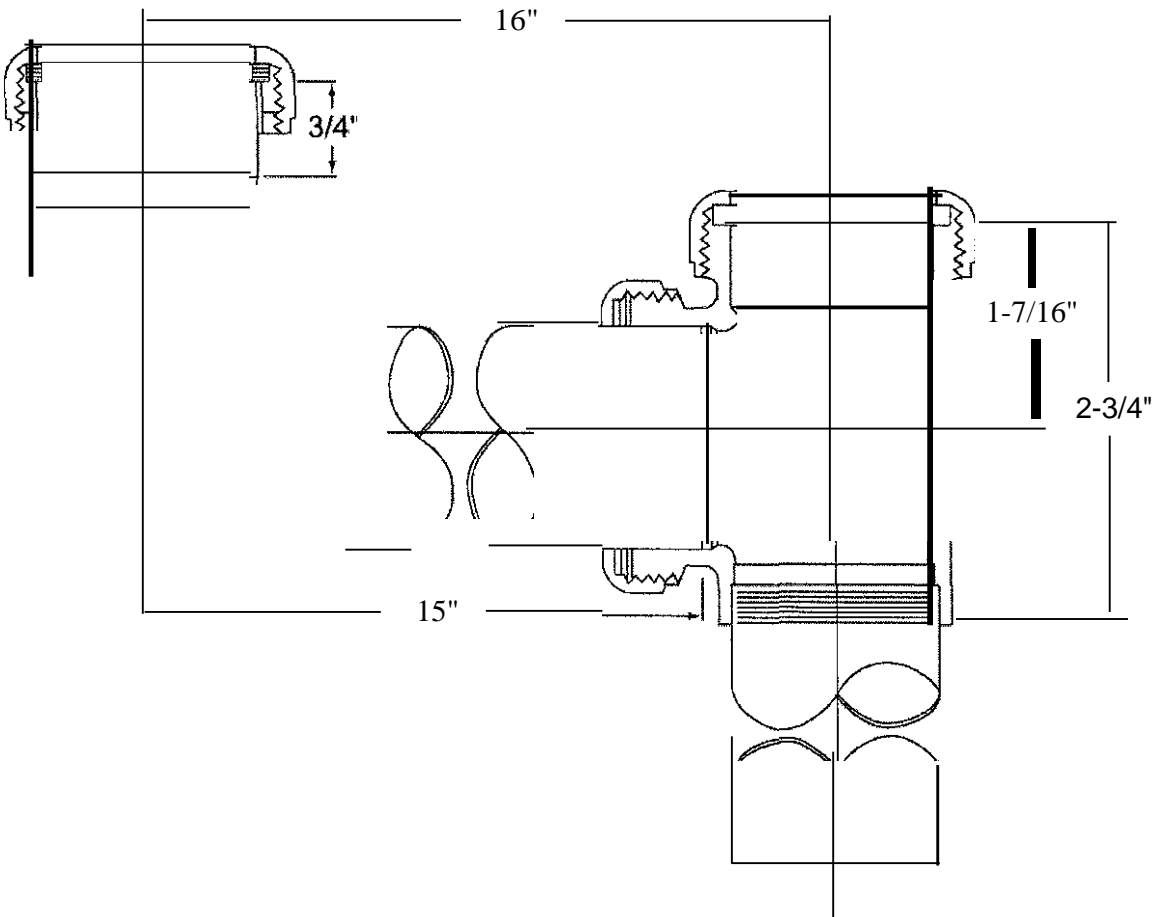

A 5/16/97 MKK JPS RELEASE

8 9/25/02 JPS KAK ADDED CHART

61-6 COMP. NUT

60-6 COMP. SLEEVE

R19 VALVE ASSY

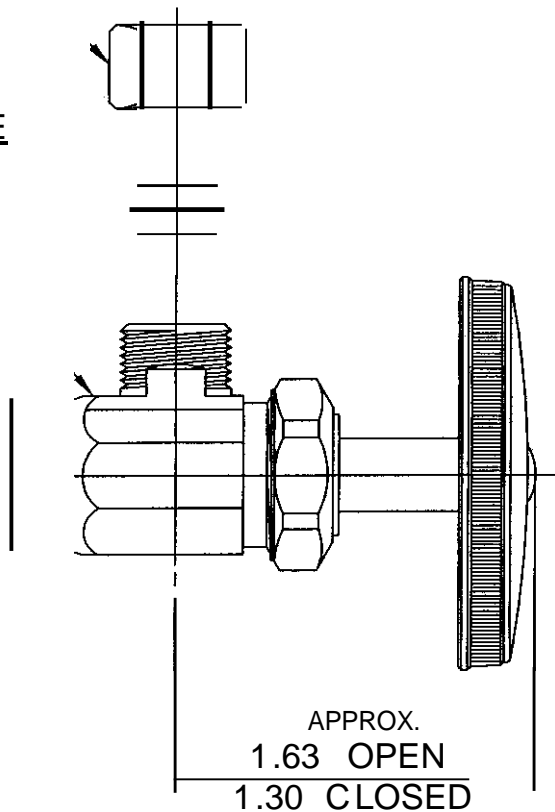

ITEM I.D. ®

CHROME

ROUGH

R19 C

R19 R

<h3>BrassCraft®</h3> <p>NOVI, MICHIGAN A Subsidiary of Mosco Corporation</p>	DESCRIPTION 1/2 NOM. SWEAT x 3/8 O.D. COMP. VALVE ASSEMBLY (SUBMITIAL)		DRAWING NO. VPA0539B
	DRAWN SCHUTIE	DATE: 5/1 5/97	MATERIAL
CHK'D. JPS	DATE' 1 /01/2002	AI-P-D. DATE,	ITEM ID R19 C SEE CHART
ALL GDT PER ANSI STD Y14.5M CLASSIFICATION OF QUALITY LEVELS CLASS SYMBOL KPC (KEY PRODUCT CHARACTERISTICS)	STPC (STANDARD PRODUCT CHARACTERISTICS)	NO: UNL.T.SS OR HERWISE SPECIFIED "TWO PLACE DECIMALS +/--.010 THREE PLACE DECIMALS +/--.005 ANGULARITY +/--1"	UNL.T.SS SCALE (UN TED) B INCH

This print and all data contained hereon is the sole and exclusive property of Brass Craft Mfg. Co., Subsidiary of Masco Corporation, and will not be disclosed to others without the consent of Brass Craft Mfg. Co. This print must be returned to Brass Craft Mfg. Co. if requested.

ITEM I.D.	FINISH
R 14 C	CHROME
R 14 R	ROUGH

R 14 VALVE ASS'Y

60-6 COMP. RING

61-6 COMP. NUT

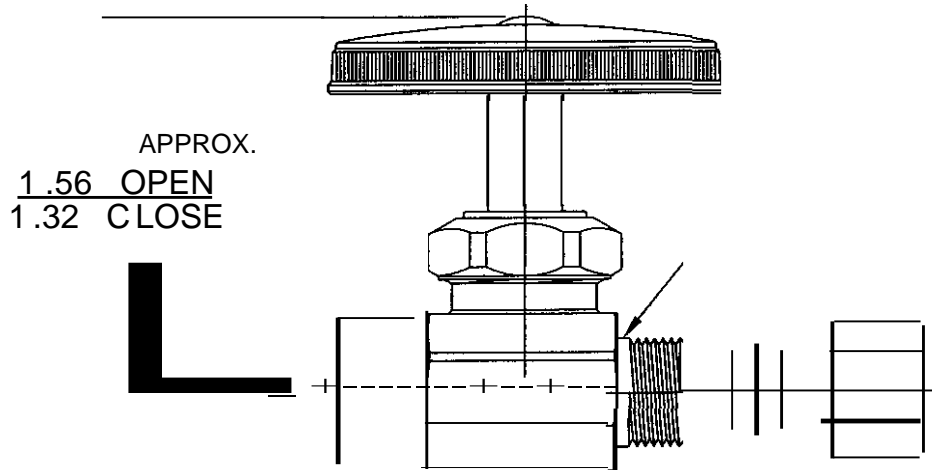

BrassCraft® NOVI, MICHIGAN A Subsidiary of Mosco Corporation	DESCRIPTION 1/2 NOM SWT X 3/8 OD COMP STRAIGHT VALVE (SUBMITIAL)		DRAWING NO. VPA0542B	
	DRAWN PERNAK 1	DATE: 2/26/2002	MATERIAL	ITEM DESCRIPTION R 14
	CHK'D. Klimkie 0	DATE: 1/14/2003	APP'D.	ITEM ID
ALL GDT PER ANSI STD Y14.5M CLASSIFICATION OF QUALITY LEVELS				
KPC (KEY PRODUCT CHARACTERISTICS)	CLASS SYMBOL	NOTE: UNLESS OTHERWISE SPECIFIED, UNITS ARE INCHES (UNLESS NOTED)	REV.	
S11'C (STANDARD PRODUCT CHARACTERISTICS)	PRODUCT MARKINGS	TWO PLACE DECIMALS +/- .010 THREE PLACE DECIMALS +/- .005 ANGULARITY +/- 1" SIZE	FULL B	

This print and oil data contained hereon is the sole and exclusive property of Brass Craft Mfg. Co., Subsidiary of Masco Corporation, and will not be disclosed to others without the consent of Brass Craft Mfg. Co. This print must be returned to Brass Craft Mfg. Co. if requested.

LET., DATE | PER BY | CHANGE

B 5/7/03 WFT MJP REVISED & UPDATED
C 5/28/03 JPS KAK REVISED DESCRIPTION

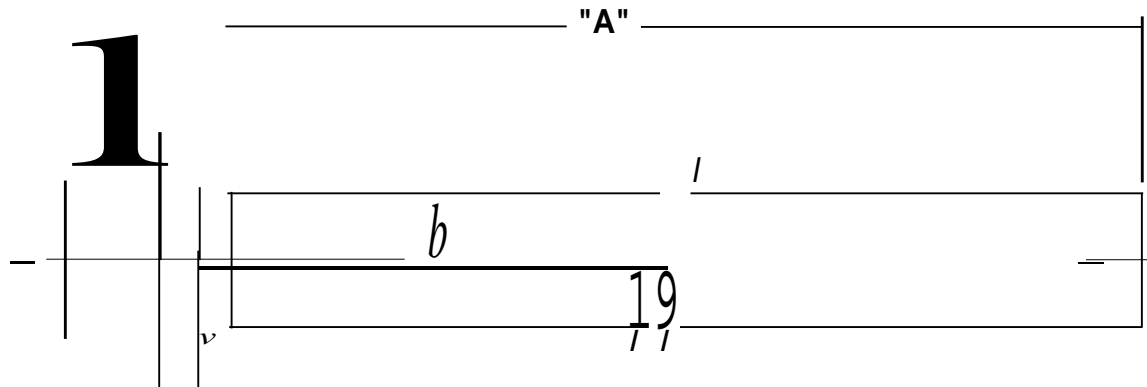

ITEM I.D.	ITEM DESC.	LENGTH 'A'
P1-12A	P1-12A	11.50
P1-15A	P1-15A	14.50
P1-20A	P1-20A	19.50
P1-30A	P1-30A	29.50
P1-36A	P1-36A	35.50

<p>Eta ssCraft®</p> <p>NOVI, MICHIGAN A Subsidiary of Mosco Corporation</p>	<p>DESCRIPTION © 3/8 OD PEX FAUCET RISER TUBE (SUBMITIAL)</p>		<p>DRAWING NO. R PA0083C</p>		
	<p>DRAWN PERNAK</p>	<p>DATE: 5/7/2003</p>	<p>MATERIAL</p>		<p>ITEM DESCRIPTION P1-12A SEE CHART</p>
<p>ALL GOT PER ANSI S1D Y14.5M CLASSIFICATION OF QUALITY LEVELS</p>		<p>CHK'G. Schutte</p>	<p>DATE: 05/28/2003</p>	<p>VOLUME</p>	<p>ITEM ID P1-12A SEE CHART</p>
<p>CUN55 S<MBJL</p> <p>KEY (KEY PRODUCT CHARACTERISTICS) SIR: (STANDARD PRODUCT CHARACTERISTICS)</p>		<p>APP'D.</p>	<p>DATE:</p>	<p>UNITS INCH</p>	
<p>PRODUCT MARKINGS C--</p>		<p>NOTE: UNLESS OTHERWISE SPECIFIED TWO PLACE DECIMALS +/- .010 THREE PLACE DECIMALS +/- .005 ANGULARITY +/- 1"</p>		<p>SIZE A</p>	<p>NOTED) REV. FULL C</p>

This print and all data contained hereon is the sole and exclusive property of Brass Craft Mfg. Co. Subsidiary of Mosco Corporation, and will not be disclosed to others without the consent of Brass Craft Mfg. Co. This print must be returned to Brass Craft Mfg. Co. if requested.

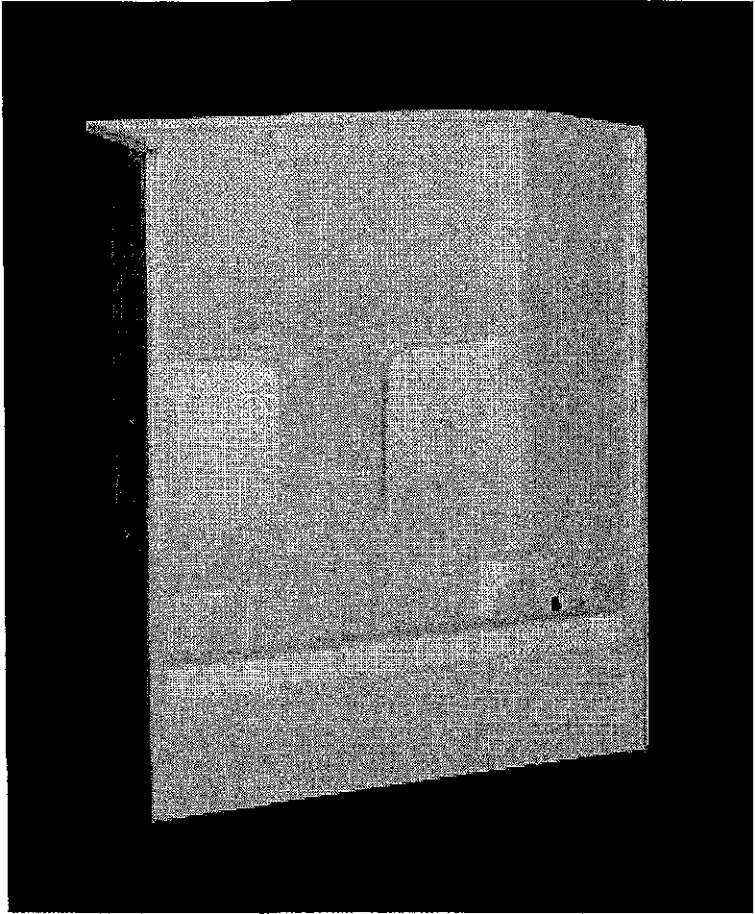
TUB/SHOWER

60-INCH MODEL

CM-60 (Smooth Wall)

Rough-In Dimensions

60" wide x 33" deep x 73-1/2" high

Finished Dimensions

60" wide x 31-1/2" deep x 72" high

Unit Features

- One - Piece Gelcoated Fiberglass
- 2" Dia. Drain/RH or LH (see reverse side for location)
- 2-1/2" Dia. Overflow (see reverse side for location)
- Twin / Elevated Bock Woll Shelves
- Single / Lower Level. Center Soop Ledge with Acrylic Bar
- Textured Floor Pattern
- Balsa Wood "Anti-flex" Floor Construction

Special Notes

- Unit Complies with ANSI Z 124 Series
- Unit Complies with HUD / FHA UM-730 (use of materials)
- Unit Available with Extended Apron (see reverse side for details)

MAAX" TUB/SHOWER

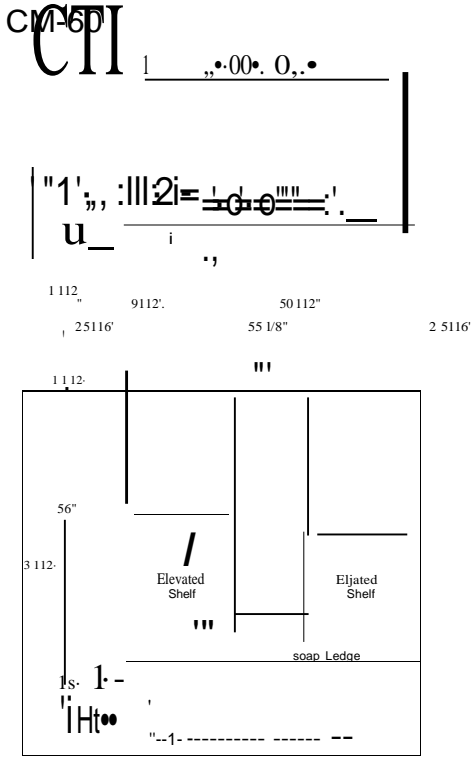

CM-60L (Illustrated)
 Sump Bottom: 16" wide x 42" long
 Sump Depth: 13-1/2" deep
 Sump Capacity: 36 gallons (to overflow)

Plain Tub/Shower

Order No.: CM - 60R (*RH Drain/Clear Acrylic Bar*)
 (LH Drain/Clear Acrylic Bar)
 CM - 60L

60" x 31-1/2", One-Piece, Gelcoated Fiberglass Tub/
 Shower with 16" apron wall surround, acrylic bar
 and drain on end indicated.

Tub/Shower Accessories

Order No.: ENC-BPTS601-CH (*Chrome trim*)
 ENC-BPTS601-PB (*Polished Brass trim*)

Custom fit. no trim tub/shower enclosure with
 caulkless wall channels, by-pass doors, obscure
 glass. and EZ Kleen door track.

Order No.: ABFLR (*17-3/4" apron*)

Extended apron height to allow for above the floor
 plumbing system on unit listed above.

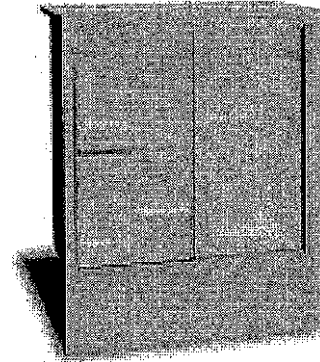

Dimensions shown are maximum. Due to the nature of the materials involved,
 actual unit dimensions con vary. (tolerances, -t-0/- 3/8 Inch)

SUBMITIAL SHEET

P3A

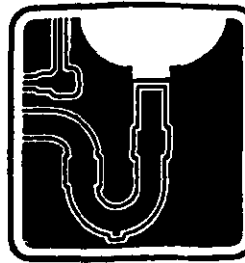

LAV GUARD™



UNOERSINK PROTECTIVE PIPE COVERS DESIGN FEATURES

- Universal design fits virtually all lavatory applications
- Antimicrobial vinyl maintains sanitary conditions
- Lock Lid™ on valve stops tampering & allows service
- Cleanout nut cap allows servl.e on trap without:lisassembl)
- Snap-Clip™ fastener is flush, nonabrasive & reusable
- Internal ribs enhance K value & soften impact cushionion>

LAV GUARD Kits Fit:

- All P-trap assemblies, cast brass or tubular - 1'•' or 1'1/2'
- All straight tail piece assemblies - 1'1/2" or 1'1z".
- All standard 5/2 offset wheelchair strainers. (Acc. #105)
- All angle stop valves - handled or keyed type 3/0 or '12.
- NOTE: LAV GUARD Kits will not fit Schedule 40 plastic P-traps

Models Available: White or Grey
Select model and color.

Model #99 O white Dgre
One angle valve and supply cover onli

Model #100 D white D gre
One P-trap cover only.

Model #101 O white Dgre
One P-trap cover, one angle valve an
supply cover.

Model #102 !Cwhite D gre
One
supply covers.

Model #103 O white D gre
One P-trap cover. two angle valve an
supply covers. one offset tailpiece whee
chair strainer cover. (Acc. #105)

Accessory #105 O white D gre
One offset tailpiece wheelchair strain<
cover only.

Approved By: _____

LIJTRUEBRO

MAKING AMERICA ACCESSIBLE

TRUEBRO, Inc.
7 Main Street • Ellington, CT 06029
(203) 875-2868 • 1-800-340-5969
Fax: (203) 872-0300 ..

PRODUCT DESCRIPTION

LAV GUARD waste and supply piping covers satisfy all ADA com-
..... ce requirements with its unique and universal design, allow-
j19 for easy installation over virtually all tubular and cast brass P-
p assemblies, as well as angle valve <1nd supply tube assem-
lies, regardless of their geometry or rotational off\$el. Smooth,
flush Snap Clip™ fasteners firmly secure piping covers in place.

SAMPLE SPECIFICATIONS

Handicap lavatory P-trap and angle valve assemblies shall be
covered with the soft, antimicrobial, LAV GUARD, piping
cover manufactured by TRUEBRO, Inc. Model # _____

Accessory # _____, color _____ (white or grey).
Piping cover shall be secured with Snap Clip™ flush mounted
fasteners. Angle s?op valve shall be secured with locking lid
access cover: Cover shall be non-yellowing and fire retardant.

12- supply tube
cover is very
flexible to fit any
bend in supply
tube. _____

Lock Lid™
offers tamper
resistance
and yet allows
service

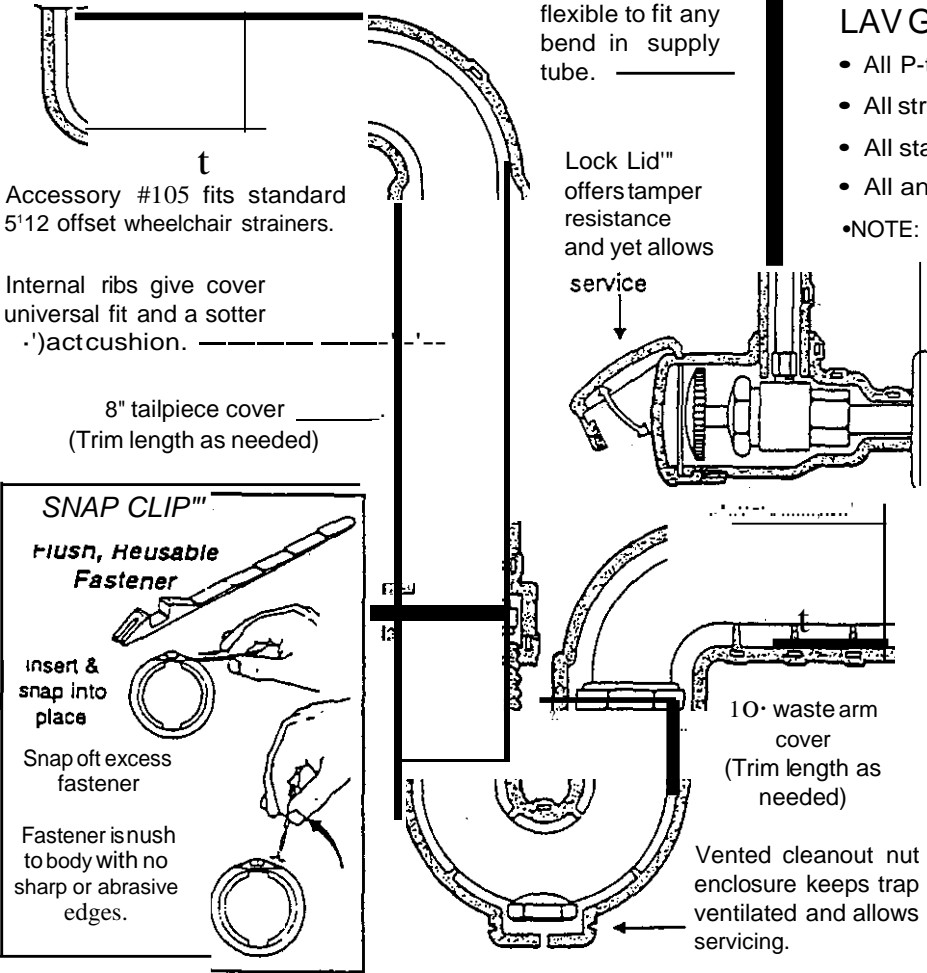

Accessory #105 fits standard
5'12 offset wheelchair strainers.

Internal ribs give cover
universal fit and a sotter
'-)actcushion.

8" tailpiece cover
(Trim length as needed)

SNAP CLIP™
**Flush, Reusable
Fastener**

insert &
snap into
place

Snap off excess
fastener

Fastener is nush
to body with no
sharp or abrasive
edges.

10- waste arm
cover
(Trim length as
needed)

Vented cleanout nut
enclosure keeps trap
ventilated and allows
servicing.

MATERIAL:	MOLDED CLOSED CELL VINYL
NOM.WALL:	1/8 INCH CONSTANT
DUROMETER:	55 • 65 • SHORE A
UV PROTECTION:	WILL NOT FADE OR DISCOLOR
DURABILITY:	VIRTUALLY INDESTRUCTIBLE
FASTENERS:	SNAP-CLIP™. FLUSH, REUSABLE
COLOR:	LIGHT GREY OR WHITE
FINISHABILITY:	APPLY ACRYLIC ENAMEL
FLAMING CHARACTERISTICS ASTM D 635:	SELF-EXTINGUISHED
THERMAL CONDUCTIVITY ASTM C 176:	BTU • IN/HR - FT • OF K VALUE • 1.17
BACTERIA/FUNGUS RESIST:	ANTIMICROBIAL VINYL FORMULA
MAINTENANCE:	USE COMMON DETERGENTS

T&S BRASS AND BRONZE WORKS, INC.

2 SADDLEBACK COVE / P.O. BOX 1088 / TRAVELERS REST, SC 29690
 PHONE 800-476-4103 FAX 864-834-3518

RECjA2ISO1
 ISO #9002

Model No.
 B-0665-BSTP / R
 Item No.:

Job Name:

Architect/Engineer Approval:

(Signature)

Notes:

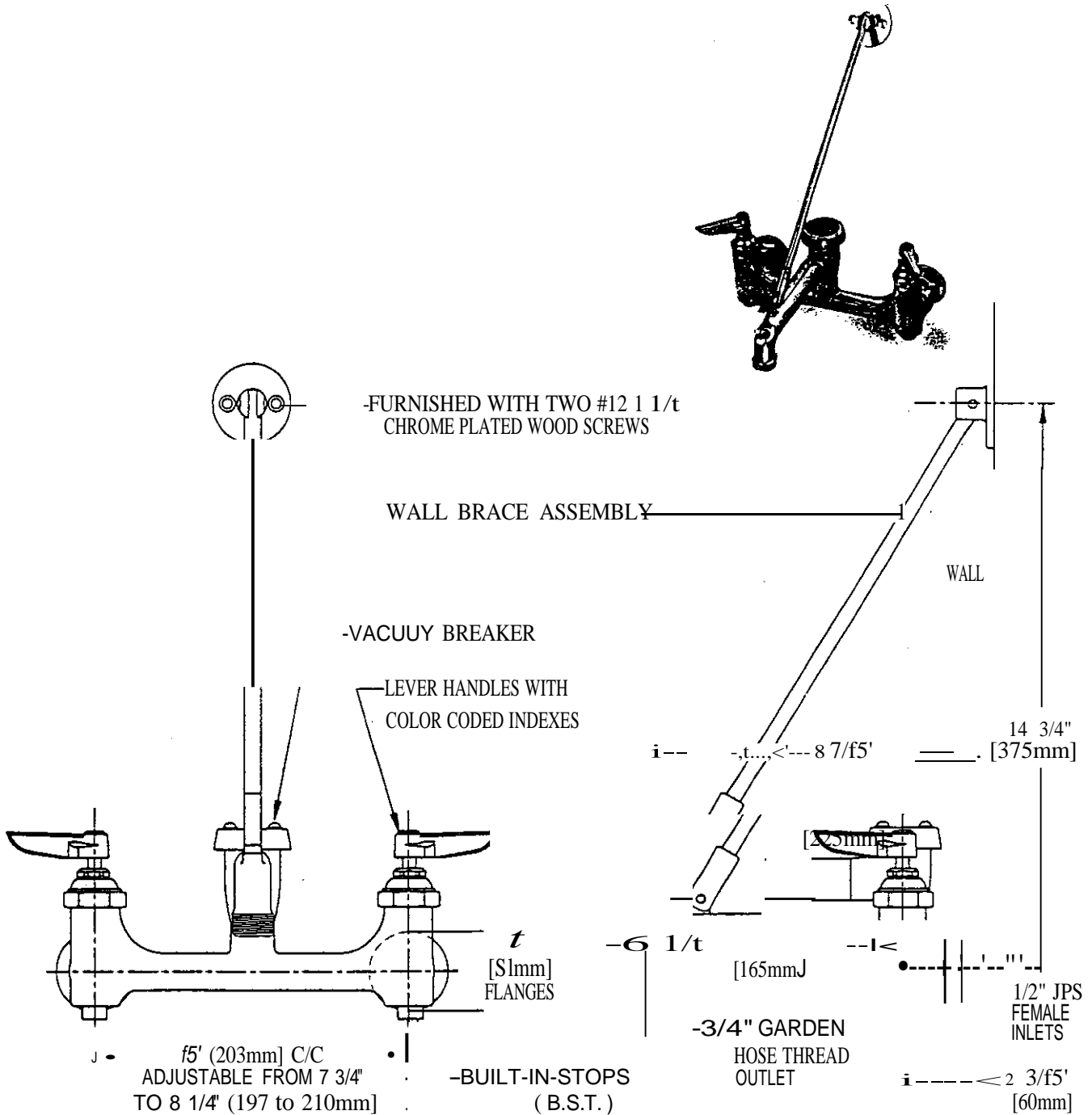

Product description:

SERVICE SINK FAUCET W/ BUILT IN STOPS, VACUUM BREAKER, LEVER HANDLES, WALL BRACE, AND AVAILABLE WITH ROUGH OR POLISHED CHROME FINISH

Drawn:
 WJS
 Approved
 CA

Checked MW	Scale: 3" = 1'
Date:	

11/22/95

...+... C, _...{...
 rTifl\...
 -fi,4 #,
 V
 L "" _ "" Jrr. Px..JJ.. c..#.1-

9-1 TUE 12:08 PM

WSC HARRISSBURG

FAX 717233191Q

JP, r.H...at

D.,, II

cc c..s..er cu uc :csa...c " -" " " " "

- laundry faucets
- Z Hula installaUon
- 4•Centarset
- fJo/l" Long, 6 1/1." high spout swlr9s 360"
- Blada handles
- Standard with '11" I.P.S.shanks
- 1/1" rap seal primer plug •

JF

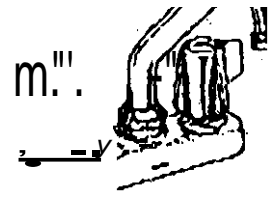

• WITH KDS(THREAD

W

• VANOAI RIISANT "CUUM 8RUIEJIFOIi US(WITH MDDfIt131 "

Chrome RP?.5695

(6)ADA

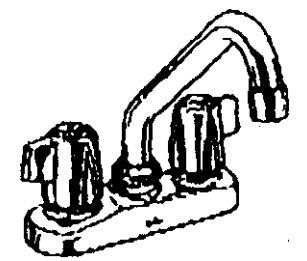

• INCLUDES STRUM ITIWCMT&MEI WITIOIT HOSETHRUO

Chrome -213.

FINISH NOcelNo:

ouAmiri

" Plug can be .-ernoved to attach a he which will enable floor drain trap to be refflod everytime faucet is used.

p<

DELTA•L SPECIALTY FAUCETS

- Two Handle Laundry Faucet
- Deck Mount
- 2 Hole Sink Applications
- 4" (102 mm) Centerset

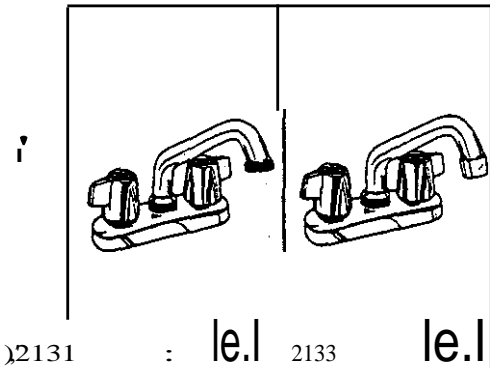

2131

le.l

2133

le.l

Submitted Model No.: _____

Specific Features: _____

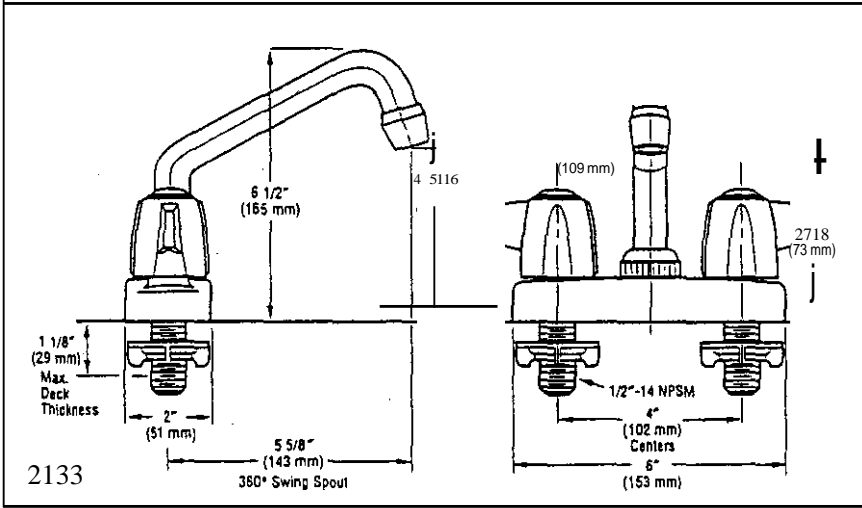
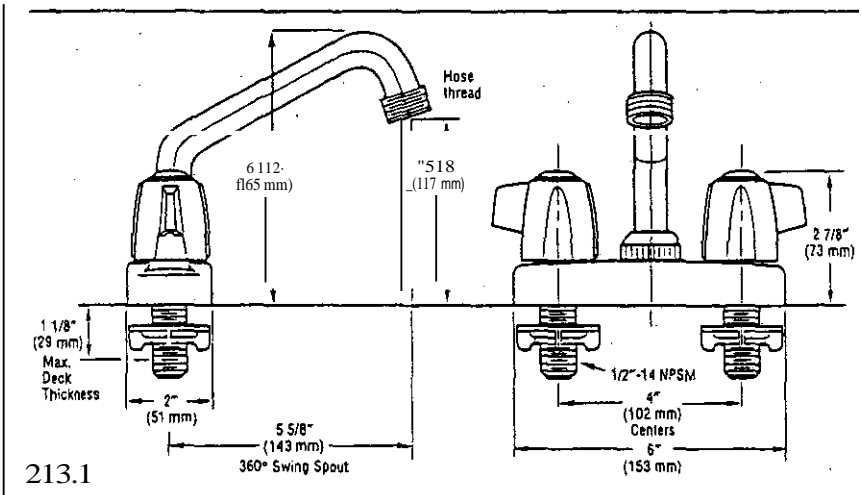

COMPLIES WITH:

- ASME A112.18.1M-1996
- CSA 8125-93
- m Indicates ADA compHance to U2J CABO/ANSI A117.1-1992
- CSA Certified

STANDARD SPECIFICATIONS:

- Two handle deck faucets for exposed mounting on 2 hole sinks.
- Solid brass fabricated body.
- 4" (102 mm) Centeriet
- 5 5/8" (143 mm) long, 6 1/2" (165 mm) highspout swings 360°.
- Hot and cold stems are interchangeable.
- Control mechanism shall be of the rotating cylinder type with stainless steel plate and 180° rotation with replaceable non-metallic seats operating in stainless steel lined sockets.
- 1/2"-14 NPSM threaded male shanks
- Trap seal primer plug.

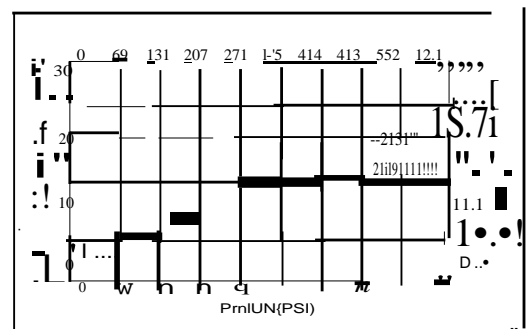

MOP SERVICE BASIN 63M

Specifications

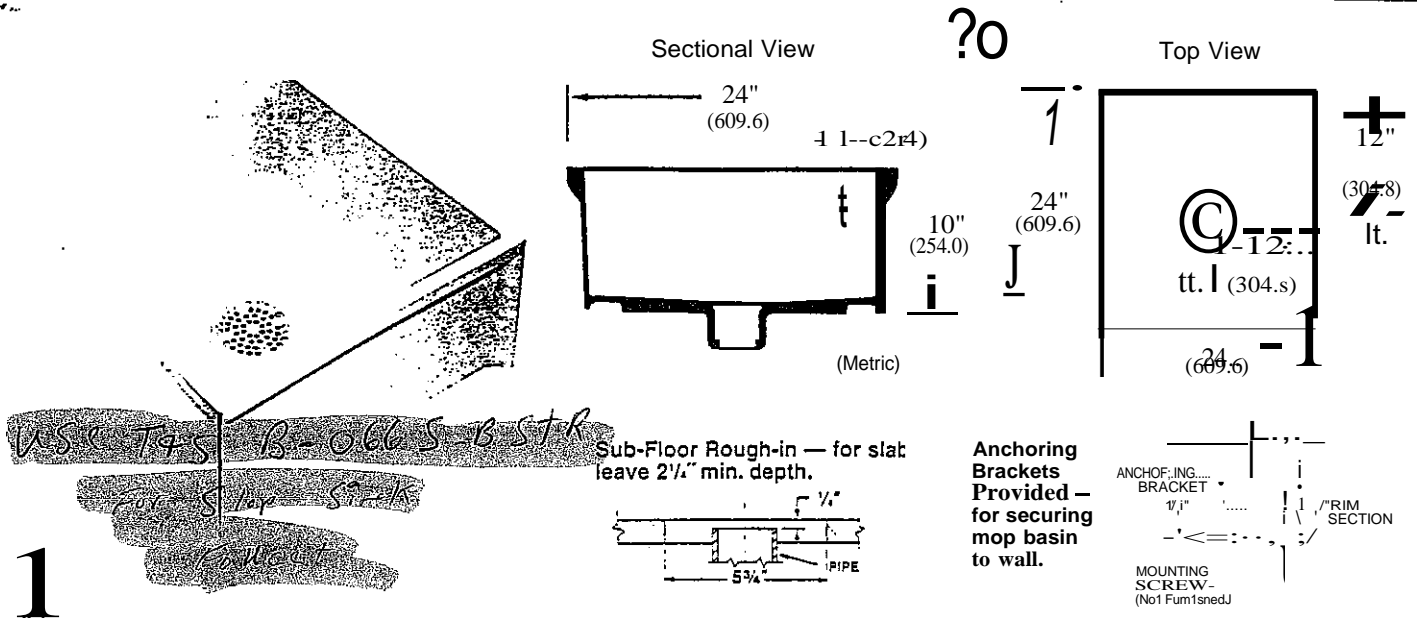

Model 63M Color White I.P.S. _____

Note: Replace furnished drain seal for installations with following pipe, order separately. Part #65.308 -for 2" PVC, ABS and iron pipe
Part #65.311 -for 3" soil pipe (no hub)

General: Furnish and install as shown on plans, Mop Service Basin model 63M, as manufactured by E.L. Mustee & Sons, Inc. Unit to be one-piece molded fiberglass made with matched metal molds using extreme heat and pressure. Height shall be 10" with not less than 1" wide shoulder. Size 24"x24", Drain shall be integrally molded, complete with drain seal for installation of 3" ABS, PVC (Sch. #80) and iron pipe. Removable stainless steel strainer. Performance tested to meet or exceed ANSI Specifications Z 124.2, Z 124.6 and FHA/HUD UM-73. Weight 45 lbs., cubic feet 4.2. Install in compliance with local codes.

IAPMO[®] Listed
File Numbers: Mop Basin -#2707

Warnock Hersey Listed
..... CSA Test Standards: Mop Basin -#B45.0 & #B45.5

ACCESSORIES -for complete details and specifications, specify literature ADV-357

Part No.	Description
63.600A	○ SERVICE SINK FAUCET — brass, chrome plated, 8" centers
65.700	E) HOSE and HOSE HOLDER -31" hose and hose holder
65.600	○ MOP HANGER -three handle holders
63.401	○ BUMPER GUARDS — vinyl, protect rims, 20 1/2" length
67.2424	○ DURAGUARD™ WALL GUARDS -two panels and corner bracket
67.24C	○ DURAGUARD™ WALL GUARD — one panel and corner bracket
65.308	DRAIN SEAL — for 2" ABS, PVC and iron pipe
65.311	DRAIN SEAL — for 3" soil pipe (no hub)

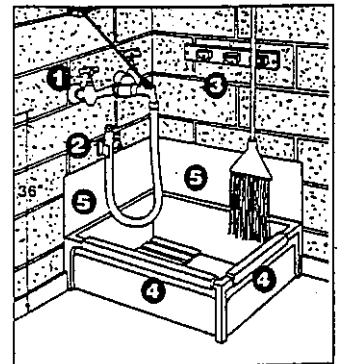

A R I ...
include service sink faucet, hose and hose holder. Ideal for bathing pets, cleaning garden utensils, toys, tools, etc.

MUSTEE

Thermoplastic and Durastone® Laundry/Utility Trays

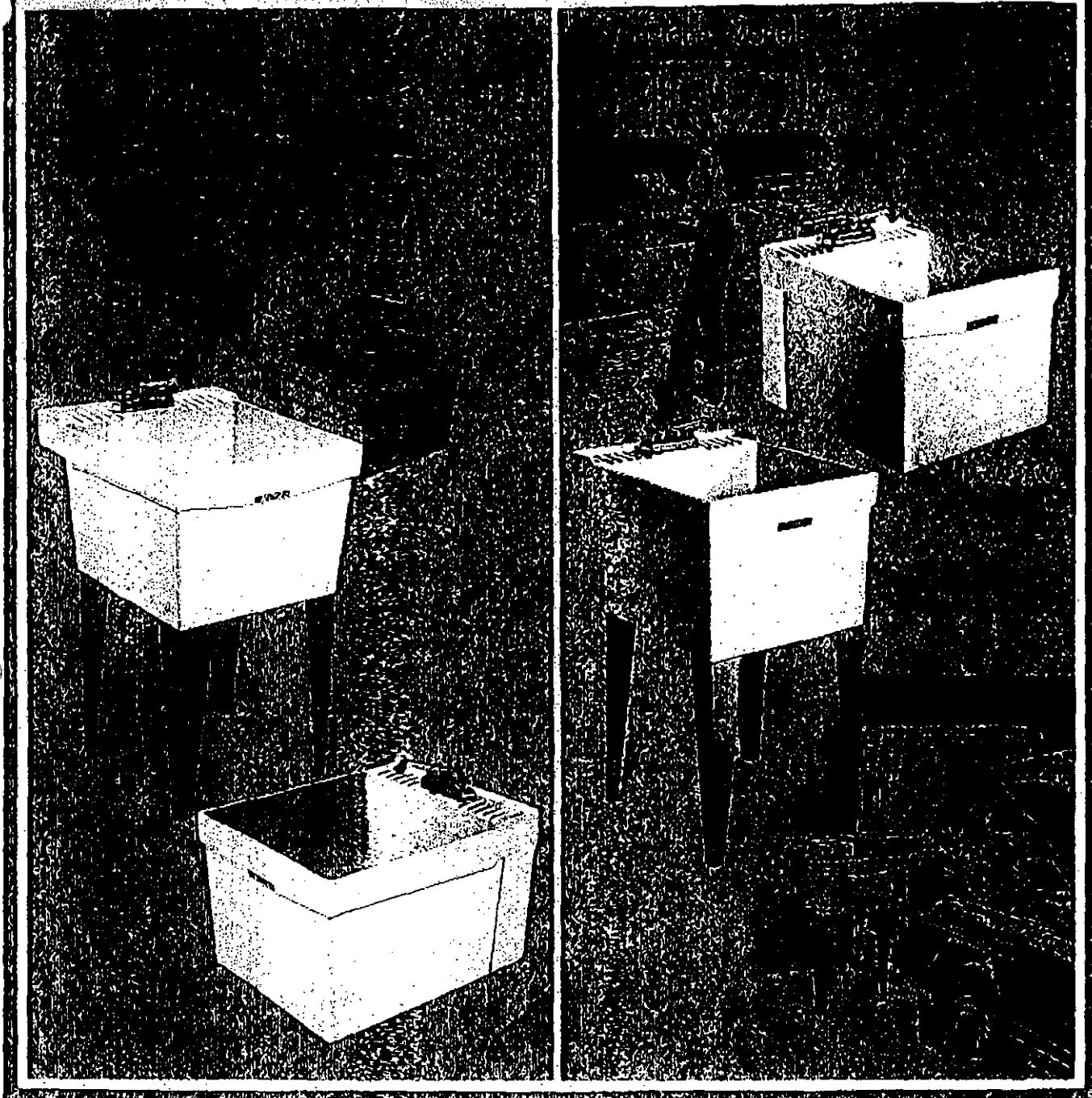

UTILATUB® 19/18

Model #
MUI9F

Mustee's UTILATUBS™ are designed with many built-in features. Sturdy floor and wall mounted models are extra tough, stain-resistant, attractive... and provide years of dependable performance.

When it's time to tackle those "tough" cleanup jobs... messy painting utensils and garden tools, family pets, grimy dirt from working on your car, doing the laundry, etc., etc., nothing works better than the convenience of a UTILATUB. So don't wait, install one next to your workbench, in your basement, garage, utility room, breezeway, on your patio... or anywhere.

UTILATUB 19

Thermoplastic Laundry/Utility Tubs

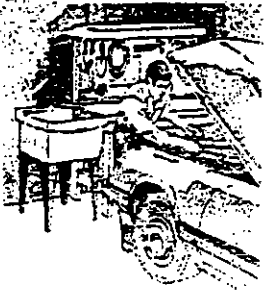

PREFERRED BY
7K "P/z-04,"

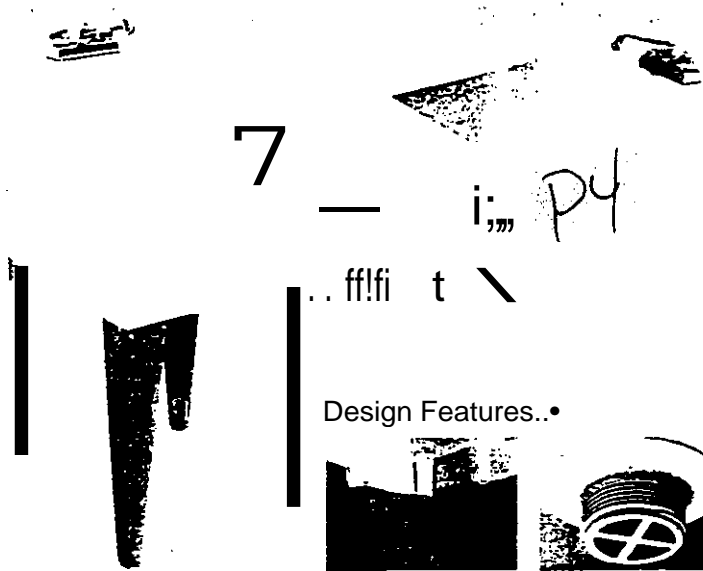

Design Features..•

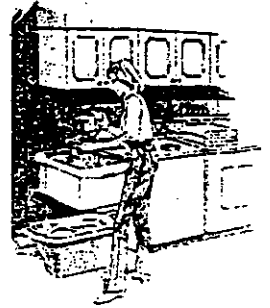

CODE APPROVED
/M

- STURDY, 1-PIECE MOLDED TUBS, MADE WITH STRUCTURAL THERMOPLASTIC
- LEAKPROOF 1" INTEGRAL DRAIN
- FLOOR and WALL MOUNTED MODELS,

- 18 GALLON CAPACITY, 13" DEEP, ONLY 20" WIDE
- SMOOTH WHITE SURFACE, RUST-RESISTANT

W.

International Association of Plumbing and Mechanical Officials (IAPMO®)-listed file #0820

LEVELERS and STOPPER INCLUDED

8 EASY TO INSTALL

CODE

American National Standards Institute (ANSI)-Specification Z 124.6

APPROVED

Warnock Hersey® (Canada)-CSA #645.0 and 645.5

SPECIFICATIONS

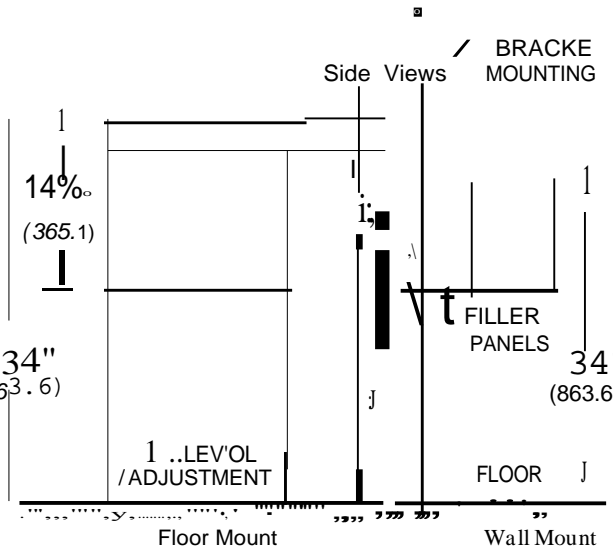
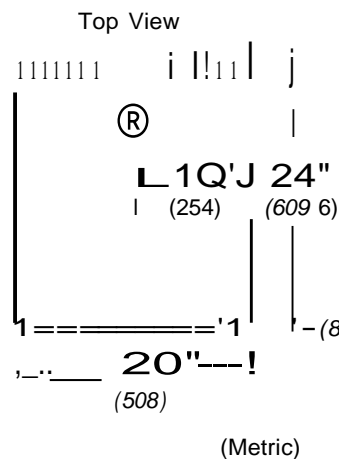

Model No. W...
Mounting r

General: Furnish and install as shown on plans, UTILATUB® Laundry/Utility Tub model (19F, 19W), as manufactured by E.L. Mustee & Sons, Inc. Tub shall be one-piece molded construction using structural thermoplastic with matched metal molds under extreme heat and pressure. Tub to include integrally molded drain assembly stopper and floor or wall mounting hardware. Shall meet ANSI Specification Z 124.6. White color. 19F weight 23 lbs.. 19W 20 lbs., cubic ft. 4.8.

ACCESSORIES.....

FAUCET #93.6DO-chrome-plated brass body. 4-c1nter sel, swing spout with

FAUCET #91.604-chrome plated celcon body and 1.1bular SWING spout

FAUCET #90.700-clamp-on. for overhead water supply. brass body with swing-spout and hose end

MOLDED FAUCET BLOC! (#20.600-used with clamp-on faucet

OVER F O i... t27,600C-prevents / water

HANOIFLOW!! FITTING #94.700" discharges water from



end.4" center set

MU "I:I: MDlit8" t: aortdry/t: Jtity Trays

- Sturdy, One-piece Construction — molded under extreme heat and pressure with matched r1stal dies.
- -iOlce ol FIOor or Wall Mounting-
- 19 Gallon Capacity -extra deep 13 inch bowl.
- Smooth Interior Surface -pre11ont fine fabric snage.
- Only 20 Inches Wide — fit where others can't
- Rust and Leak-resistant -easy to clean.
- Ouk:k'n Easy_ to Assemble andhstall.

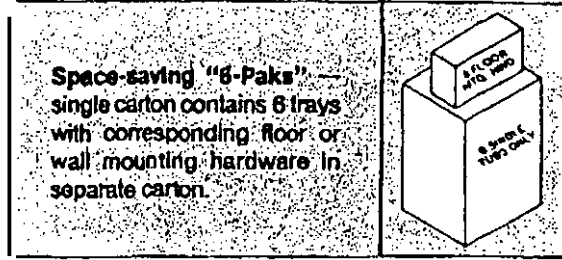

• Sun: 1y-logs alida into inug tlnr19 loU supporta. Level 10g d0'ie: e3. includ Qd.

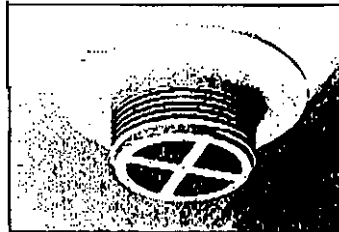

Leatoot 1 4f'llln mol-fod as integral pa'1 of tray, ro Outly or aeals reqo'rod.

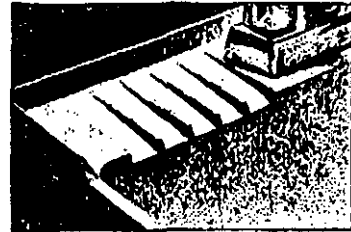

Built-in twin soap/storage shelves with rubber surface permit rapid drainage of soapy water and lather.

BULTN FEATURES

MATERIALS

Tharmop&astlc -structural Poltr1 ler materials with cellufat construction, white (Xlor. Du111atone-rfxiture of nbqrgJass and shed steno. blended with !lpecla.l formu-Hed resis, marbelzvt white color.

SPECIFICATIONS & ORDERING INFORMATION

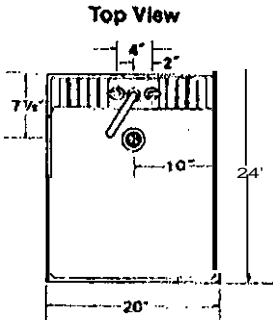

Model No. MttrotOI MounUng SIZdli;WICli) Cap11ehy Welgrn cu. Ft. Stlfpplng

19i The; ;j; ;ic 'Fk; or	24-x20-x35-19C81	23 lbs. 4.8
19W ThennopJaotic Wall	24"x20"xAdj.	19 Gal. 20 lbs. 4.8
D; ; ; ; ; Floor	24" :?O" ; ;is' 19Gal.	32 lbs. 4.8
18W Ourastone" Wall	24"x20"xAdj.	19 Gal. 28 lbs. 4.8

•L. Jngtn; W-Wkllh; H"t>elght. (C'nl No. 3;427.11*4a" d p; Jnntf p11; 118111. Note: When olOor1ng "6-Paks.. (duid carton) use following.suffill OQdM: 1-9FK for floor mounted 1rays ana hardware, 110lbs.; 13.5 cubic ft. t9WK for wall mounted trays and hardware, 102lbs.; 13.5 cubic ft. 1BFK for fJoot mounted traya end hardware 1G. 159 ba., 13.5 cvbl<. It. 1SWK for waH mouned trays and liardwar&, 146ba.; 13.5 cvbic tt

General:F.1.1r'l'fch and install as shown on plne _____ UTILATUB laundry tray(s) as m.1;nvla.cturecf by E.I.Mustoe & Sons. hc., Model

MoCij\$ '19f/w. One--piece molded construction using .struc1ural thrmoplaS. ic, complete with drain assGmbly and floor or wall mounting hardware.

eJs 18F'W. One-plEX: e molded-conslruclion using nat'urat c: rvS11 stone wi ti l)Olyesler resin. c: ompleta with drain 8'35tm'lbly and floor or wall mounti11g hardware.

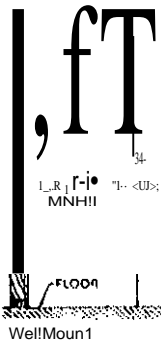
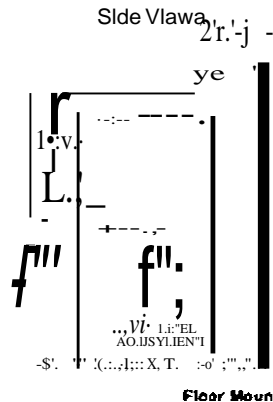

Wall Mounting Bracket

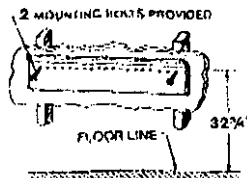

Mounting Bracket — easily mounted to studs, concrete or block walls. Wall mount models include side fillers.

Optional Accessories

FAUCET — Chrome plated, 1/2" ceramic set, brass body and swing spout with hose end. Part No. 83,800

FAUCET — Chrome plated, 1/2" ceramic set, brass underbody and tubular swing spout with hose end. Part No. 87,604

FAUCET — Chrome plated heavy brass body with swing spout and hose end. Part No. 90,700

FAUCET BLOCK — for use with overhead water supply, deluxe molded. Part No. 20,600

OVERFLOW TUBE — prevents water overflow. Part No. 27,600C

DRAIN HOSE — tough, flexible 32' connector hose. Part No. 12,301A

To reorder this literature please refer to catalog number ADV-2-111.

Notte: Our commitment to quality and customer service is our top priority. We are committed to providing the highest quality products and services to our customers. We are committed to providing the highest quality products and services to our customers.

WIPER 186 flushometer

Regal® Model 186 Flushometer

186
 186-1 *MAC Standard*
 186-0.5

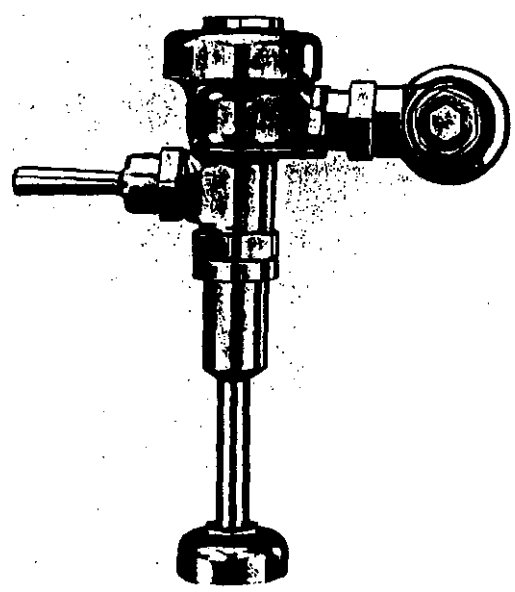

Description

Exposed Urinal Flushometer for 1/2" tap spud urinals.

Flush Cycle

- Model 186 Water Saver (1.5 gpf/5.7 LpQ)
- Model 186-1 Low Consumption (1.0 gpf/3.8 LPO)
- Model 186-0.5 (0.5 gpf/1.9 LpQ)

Specifications

Quiet, Exposed, Diaphragm Type, Chrome Plate Urinal Flushometer with the following features;

- Metal Oscillating Non-Hold-Open Handle
- 1/2" LP.S. Screwdriver Bak-Chek™ Angle Stop
- Vandal Resistant Stop Cap
- Adjustable Tailpiece
- Vacuum Breaker Flush Connection
- Spud Coupling, Wall and Spud Flange for 3/4" Top Spud
- Low Consumption flush accuracy controlled by Para-Flo™ Inside Parts Kit
- Handle Packing, Stop Seat and Vacuum Breaker to be molded from PEAMEX™ rubber compound for Chloramine resistance

Valve Body, Cover, Tailpiece and Control Stop shall be in conformance with ASTM Alloy Classification for Semi-Red Brass. Valve shall be in compliance to the applicable sections of ASSE 1037, ANSISME 112.19.6, and Military Specification V-29193.

Variations

- ADA ADA Compliant Handle **IV**
- BG Bio-Gard™ Handle **III**
- YB Sweat Solder Adapter Kit with Stamped Flange
- YBYC Sweat Solder Adapter & Cast Wall Flange w/Set Screw

REGALXI

Flushometer includes ADA Compliant Handle, Vandal Resistant Stop Cap with Set Screw, and Sweat Solder Adapter with Cover Tube and Cast Set Screw Wall Flange.

See Accessories Section of the Sloan catalog for details on these and other Flushometer variations,

@ (R) Certified

Valve (R) Listed by IAP.M.O.

This space for Architect/Engineer approval

The information contained in this document is subject to change without notice.

SLOAN.

Made in the U.S.A.

SLOAN VALVE COMPANY • 10500 SEYMOUR AVE. • FRANKLIN PARK, IL 60131
 PHONE: 1-800-982-5639 • FAX: 1-800-447-8329 • <http://www.sloanvalve.com>

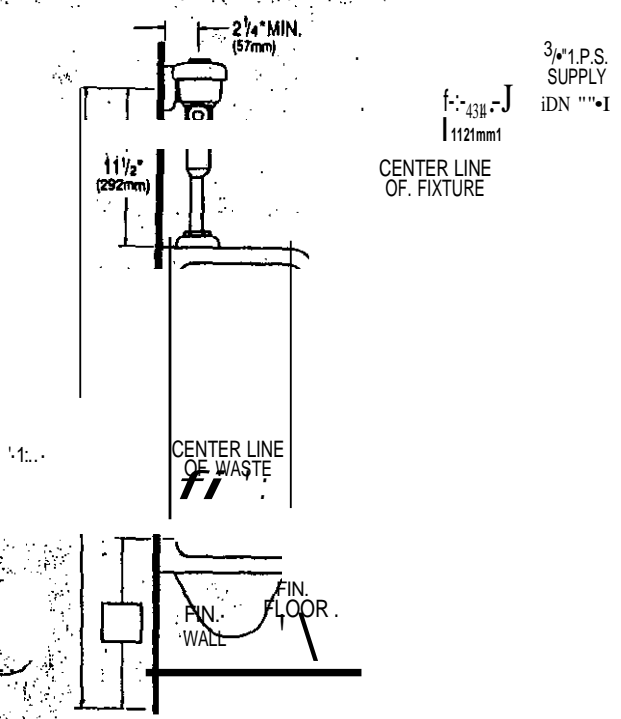

195 ES-S 195-1 ES-S 195-0.5 ES-S

..... Description
Concealed Sensor Operated Urinal Flushometer, for 3/ back spud urinals.

- ||o- Flush Cycle
 - D Model 195 ES-S Water Saver (1.5 gpf/5.7 Lpn)
 - g Model 195-1 ES-S Low Consumption (1.0 gpf/3.8 Lpn)
 - O Model 195-0.5 ES-S (0.5 gpf/1.9 Lpn)

- Specifications
- Quiet, Concealed, Diaphragm Type, Rough Brass Urinal Flushometer for either left or right hand supply with the following features:
- Dual Filtered By-Pass
 - OPTIMA7.I EL-1500 Self Adaptive Infrared Sensor with Indicator Light
 - Non-Hold-Open Integral Solenoid Operator
 - Chrome Plated Wall Cover Plate (for 2-gang Electrical Box) with Vandal Resistant Screws
 - ¾" I.P.S. Wheel Handle Bak-Chek™ Angle Stop
 - Sweat Solder Adapter
 - Adjustable Tailpiece
 - High Back Pressure Vacuum Breaker Flush Connection and Spud Coupling for ¾" Concealed Back Spud

Valve Body, Cover, Tailpiece and Control Stop shall be in conformance with ASTM Alloy Classification for Semi-Red Brass. Valve shall be in compliance with the applicable sections of ASSE 1037, ANSI/ASME A112.19.6 and Military Specification V-29193. Installation conforms to ADA requirements.

..... L Dimension
Specify the "L" Dimension for the proper length of the Flush Connection. The "L" Dimension is equal to the Wall Thickness (to the nearest whole inch) plus 23/.

- Accessories
- O EL-154 Transformer (120 VAC/24 VAC 50 VA.)
 - O EL-342 Transformer (240 VAC/24 VAC 50 VA.)

See Accessories Section and Optima Accessories Section of the Sloan catalog for details on these and other Optima Flushometer variations.

® Listed @ Listed  listed by AP.M.O.

This space for Architect/Engineer approval

Job Name _____ Date _____

Model Specified _____ Quantity _____

Variations Specified _____

Customer/Wholesaler _____

Contractor _____

Architect _____

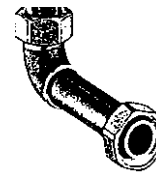
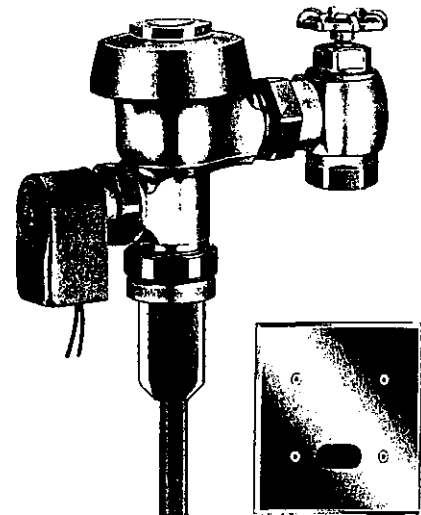

..... Automatic
Sloan OPTIMA; equipped Flushometers provide the ultimate in sanitary protection and automatic operation. There are no handles to trip or buttons to push. The Flushometer operates by means of an infrared sensor that adapts to its surroundings. Once the user enters the sensor's effective range and then steps away, the Flushometer Solenoid initiates the flushing cycle to flush the fixture.

||o- Hygienic
User makes no physical contact with the Flushometer surface. Helps to control the spread of infectious diseases. 24 Hour Sentinel Flush keeps fixture fresh during periods of non-use.

..... Economical
Automatic operation provides savings in water over other flushing devices. Reduces maintenance and operation costs.

Practical
Solid state electronic circuitry assures years of dependable, trouble-free operation. The operational components of the Flushometer are identical to a handle operated Royal Flushometer, proven by 90 years of experience.

||o- Warranty
3 year (limited)

||o- Made in the U.S.A.

195 ES-S 195-1 ES-S 195-0.5 ES-S

.... Description

Concealed Sensor Operated Urinal Flushometer, for 34" back spud urinals.

Flush Cycle

D Model 195 ES-S Water Saver (1.5 gpf/5.7 Lp0)

D Model 195-1 ES-S Low Consumption (1.0 gpf/3.8 Lp0)

0 Model 195-0.5 ES-S (0.5 gpf/1.9 Lp0)

ELECTRICAL SPECIFICATIONS

.... Control Circuit

Solid State
24 VAC Input
24 VAC Output
B sec. Arming Delay
24 Hour Sentinel Flush

OPTIMA Sensor Range

Nominal 15'-30" (381-762mm)
Self-adaptive Window: ± 8" (203mm)

.... Solenoid Operator

24 VAC, 50/60 Hz

Transformers

Sloan Part #EL-154
120 VAC, 50/60 Hz Primary
24 VAC, 50/60 Hz Secondary
Class II, UL Listed
50 VA.

Sloan Part #EL-342

240 VAC, 50/60 Hz Primary
24 VAC, 50/60 Hz Secondary
Class II, UL Listed
50 VA.

One Transformer serves up to ten (10) OPTIMA Closet/Urinal Flushometers. Specify number of transformers required accordingly.

WIRING DIAGRAM

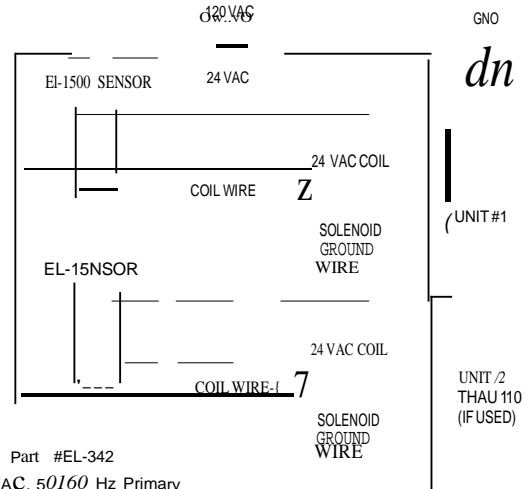

OPERATION

1.

A continuous, invisible light beam is emitted from the OPTIMA Sensor.

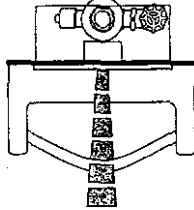

2.

As the user enters the beam's effective range (15" to 30") the beam is reflected into the OPTIMA's Scanner Window and transformed into a low voltage electrical circuit. Once activated, the Output Circuit continues in a "hold" mode for as long as the user remains within the effective range of the Sensor.

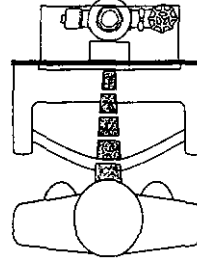

3.

When the user steps away from the OPTIMA Sensor, the circuit immediately initiates an electrical "one-time" signal that operates the Solenoid. This initiates the flushing cycle to flush the fixture. The Circuit then automatically resets and is ready for the next user.

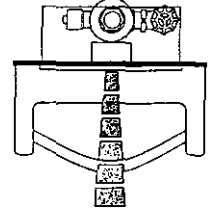

L Dim.

23/4" (70 mm) ± I
+WALL
THICKNESS

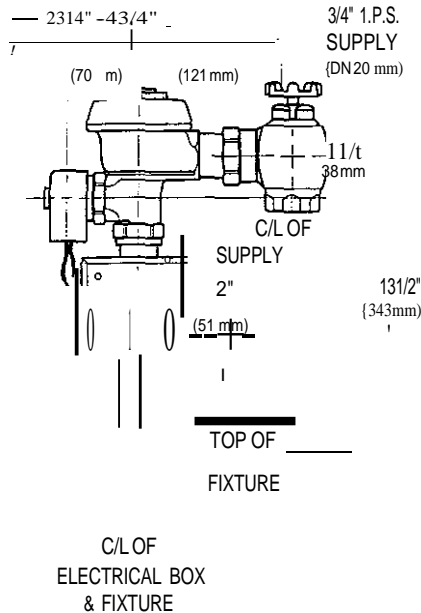

ELECTRICAL BOX INSTALLATION

SENSOR LOCATION AND POSITIONING IS CRITICAL

Failure to properly position the electrical boxes to the plumbing rough-in will result in improper installation and impair product performance. All tradesmen (plumbers, electricians, tile setters, etc.) involved with the installation of this product must coordinate their work to assure proper product installation.

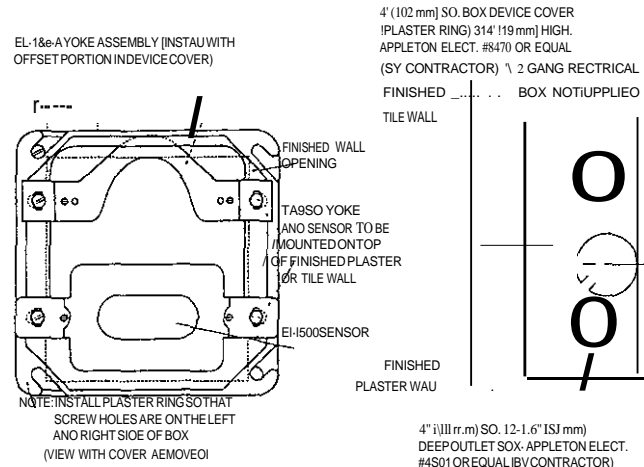

SLOAN VALVE COMPANY • 10500 SEYMOUR AVENUE • FRANKLIN PARK, ILLINOIS 60131

toilet flusher

Regal® Model 110 Flushometer

110
111 Mc Standard

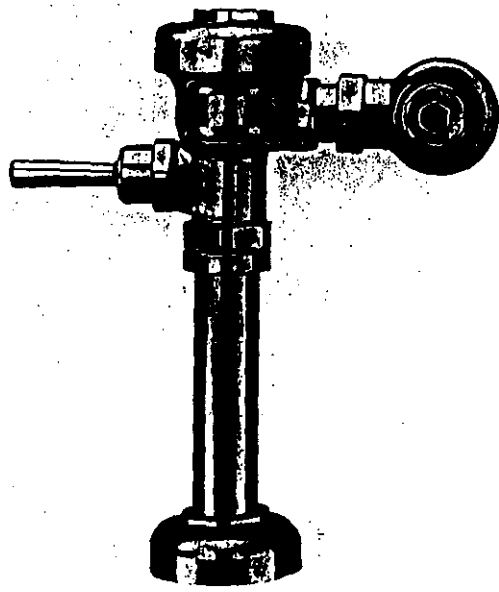

III> Description
Exposed Water Closet Flushometer, (of floor mounted or wall hung top spud b/wls.)

III> Flush Cycle:
 O Model 110 Water Saver (3.5 gpt/13.2 Lp)j
 O Model 111 Low Consumption (1.6 gpf/6.0 LpO)

..... Specifications

Quiet, Exposed, Diaphragm Type, Chrome Plated Closet Flushometer with the following features:

- Metal Oscmating Non-Hold-Open Handle
- 1" I.P.S. Screwdriver Bak-Chek™ Angle Stop
- Vandal Resistant Stop Cap
- Adjustable Tailpiece
- Vacuum Breaker.. Flush Connection
- Spud Coupling, Wall and Spud Flanges for 1 1/2" Top Spud
- Low Consumption flush accuracy controlled by Para-Flo™ Inside Parts Kit
- Handle Packing, Stop Seat and Vacuum Breaker lobe molded from PERMEX™ rubber compound for Chloramine resistance

Valve Body, Cover, Tailpiece and Control Stop shall be in conformance with ASTM Alloy Classificaon for Semi-Red Brass. Valve shall be in compliance to the applicable sections of ASSE 1037, ANSI/ASME 112.19.6, and Military Specification V-29193.

... variations

- O ADA ADA Compliant Handle II
- O BG Bio-Gard™ Handle II
- DTP Trap Primer
- O YB Sweat Solder Adapter Kit with Stamped Flange
- O YBYC Sweat Solder Adapter & Cast Wall Flange w/Set Screw
- O YO Bumperon Angle Stop

O REGAL XL
 Flushometer Includes ADA Compliant Handle, Vandal Resistant Stop Cap with Set Screw, and Sweat Solder Adapter with Cover Tube and Cast Set Screw Wall Flange.

• see Accessories Section of the Sloan catalog for details on these and other Flushometer variations.

© Certified

© listed by t.A.P.M.O.

This space for Archilec V Engineer approval

The information contained in this document is submitted to change without notice. Made in the U.S.A.

SLOAN.

SLOAN VALVE COMPANY • 10500 SEYMOUR AVE. • FRANKLIN PARK, L 60131
 PHONE: 1-800-982-5639 • FAX: 1-800-447-8329 • <http://www.sloanvalve.com>

/-
\\.

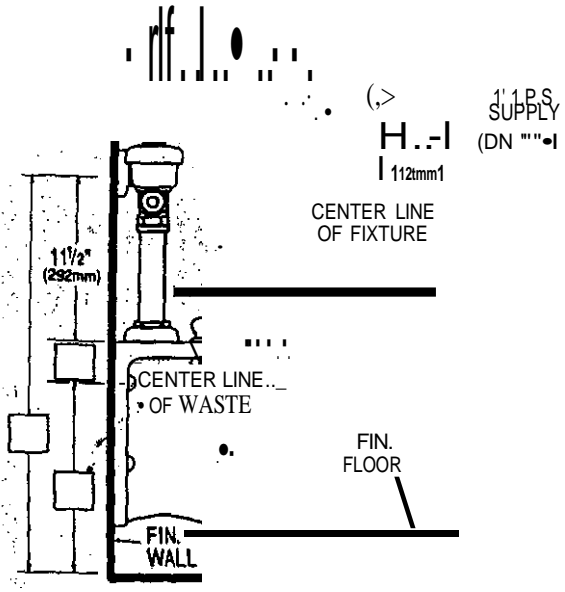

152 ES-S 152-1.6 ES-S

► **Description**
Concealed Sensor Operated Water Closet Flushometer, for wall hung back spud bowls.

Flush Cycle

- Model 152 ES-S Water Saver (3.5 gpf/13.2 LpD)
- Model 152-1.6 ES-S Low Consumption (1.6 gpf/6.0 LpD)

Specifications

Quiet, Concealed, Diaphragm Type, Rough Brass Closet Flushometer with the following features:

- Dual Filtered By-Pass
- OPTIMA™ EL-150() Self Adaptive Infrared Sensor with Indicator Light
- Courtesy Flush™ Over-ride Button
- Non-Hold-Open Integral Solenoid Operator
- Chrome Plated Wall Cover Plate (for 2-gang Electrical Box) with Vandal Resistant Screws
- 1" LP.S. Wheel Handle Bak-Chek™ Angle Stop
- Sweat Solder Adapter
- Adjustable Tailpiece
- High Back Pressure Vacuum Breaker Flush Connection and Spud Coupling for 1Y2" Concealed Back Spud

Valve Body, Cover, Tailpiece and Control Stop shall be in conformance with ASTM Alloy Classification for Semi-Red Brass. Valve shall be in compliance with the applicable sections of ASSE 1037, ANSI/ASME A 112.19.6 and Military Specification V-29193. Installation conforms to ADA requirements.

..... **L Dimension**
Specify the "L" Dimension for the proper length of the Flush Connection. The "L" Dimension is equal to the Wall Thickness (to the nearest whole inch) plus 23/4".

..... **Variations**
DTP Trap Primer Elbow
DYI Two Wan Bumpers (to open front seat without cover)

.... **Accessories**
 EI-154 Transformer (120 VAC/24 VAC 50 VA.)
 EL-342 Transformer (240 VAC/24 VAC 50 VA.)

See Accessories Section and Optima Accessories Section of the Sloan catalog for details on these and other Optima Flushometer variations.

® Listed @ Registered ® Listed by I.A.P.M.O.

This space for Architect/Engineer approval

Job Name _____, Date _____

Model Specified _____, Quantity _____

Variations _____, Specified _____

Customer/Wholesaler _____

Contractor _____

Architect _____

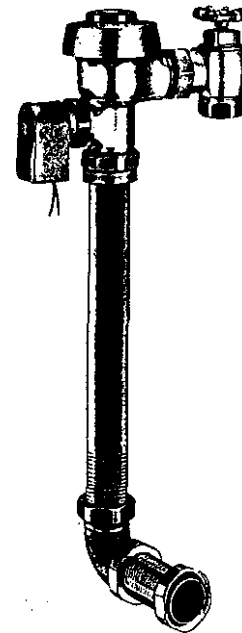

.... **Automatic**
Sloan OPTIMA e=Jipped Flushometers provide the ultimate in sanitary protection and automatic operation. There are no handles to trip or buttons to push. The Flushometer operates by means of an infrared sensor that adapts to its surroundings. Once the user enters the sensor's effective range and then steps away, the Flushometer Solenoid initiates the flushing cycle to flush the fixture.

Hygienic
User makes no physical contact with the Flushometer surface. Helps to control the spread of infectious diseases. 24 Hour Sentinel Flush keeps fixture fresh during periods of non-use.

Economical
Automatic operation provides savings in water over other flushing devices. Reduces maintenance and operation costs.

Practical
Solid state electronic circuitry assures years of dependable, trouble-free operation. The operational components of the Flushometer are identical to a handle operated Royal Flushometer, proven by 90 years of experience.

.... **Warranty**
3 year (limited)

.... **Made in the U.S.A.**

152 ES-S 152-1.6 ES-S

Description

Concealed Sensor Operated Water Closet Flushometer, for wall hung back spud bowls.

Flush Cycle

CJ Model 152 ES-S Water Saver (3.5 gpf/13.2 Lpf)

iJ Model 152-1.6 ES-S Low Consumption (1.6 gpf/6.0 Lpf)

ELECTRICAL SPECIFICATIONS

Control Circuit

Solid State
24 VAC Input
24 VAC Output
8 sec. Arming Delay
3 sec. Flush Delay
24 Hour Sentinel Flush

Solenoid Operator

24 VAC, 50/60 Hz

Transformers

Sloan Part #EL-154
120 VAC, 50/60 Hz Primary
24 VAC, 50/60 Hz Secondary
Class II, UL Listed
50 VA.

OPTIMA Sensor Range

Nominal 22"-42" (559-1067mm)
Self-adaptive Window: ± 10" (254mm)

Sloan Part #EL-342
240 VAC, 50/60 Hz Primary
24 VAC, 50/60 Hz Secondary
Class II, UL Listed
50 VA.

OPERATION

1. A continuous, invisible light beam is emitted from the OPTIMA Sensor.

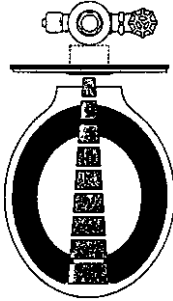

2. As the user enters the beam's effective range (22" to 42") the beam is reflected into the OPTIMA's Scanner Window and transformed into a low voltage electrical circuit. Once activated, the Output Circuit continues in a "hold" mode for as long as the user remains within the effective range of the Sensor.

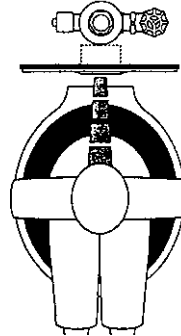

3. When the user steps away from the OPTIMA Sensor, the circuit waits 3 seconds (to prevent false flushing) then initiates an electrical "one-time" signal that operates the Solenoid. This initiates the flushing cycle to flush the fixture. The Circuit then automatically resets and is ready for the next user.

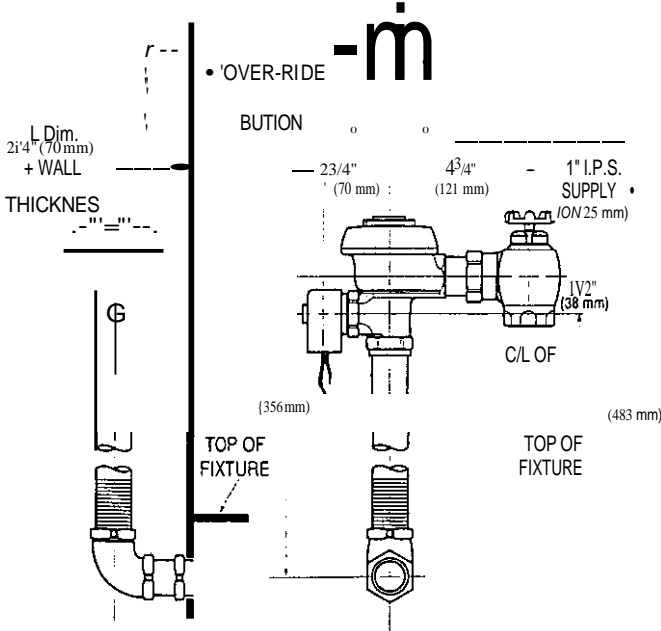
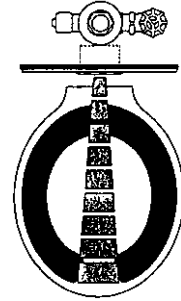

Position of Sensor Box can be raised or lowered 1" (25 mm) if in conflict with Handicap Grab Bars.

ELECTRICAL BOX INSTALLATION LOCATION AND POSITIONING IS CRITICAL

Failure to properly position the electrical boxes to the plumbing rough-in will result in improper installation and impair product performance. All tradesmen (plumbers, electricians, tile setters, etc.) involved with the installation of this product must coordinate their work to assure proper product installation.

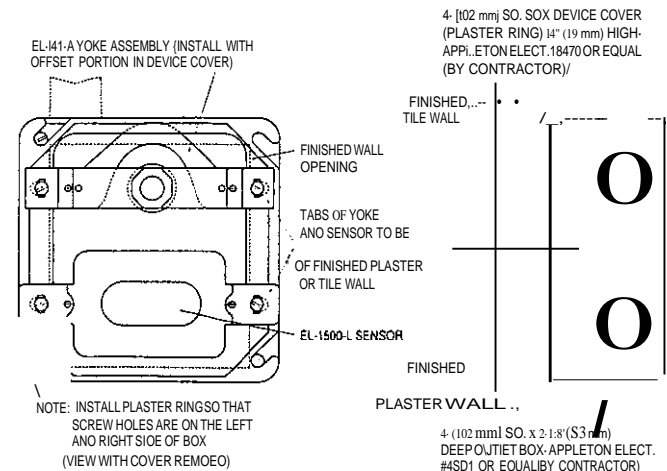

WIRING DIAGRAM

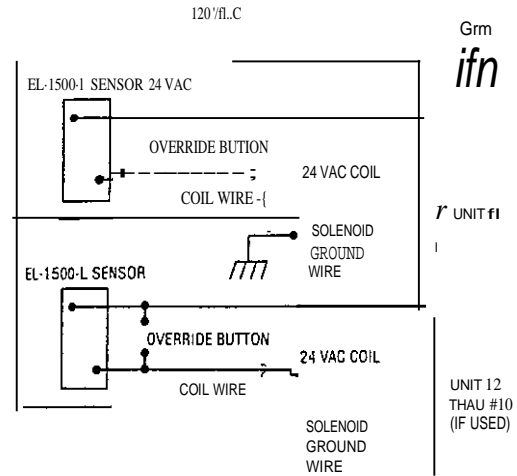

One Transformer serves up to ten (10) OPTIMA Closet/Urinal Flushometers. Specify number of transformers required accordingly.

8110-MC 8111-MC

Description

Exposed, Battery Powered, Sensor Operated Royal Water Closet Flushometer with Metal Cover, for floor mounted or wall hung top spud bowls.

Flush Cycle

0 Model 8110-MC Water Saver (3.5 gpf/13.2 LpD)

}iii Model 8111-MC Low Consumption (1.6 gpf/6.0 LpD)

.... Specifications

Quiet, Exposed, Diaphragm Type, Chrome Plated Closet Flushometer for either left or right hand supply with the following features:

- ADA Compliant OptimaPLUS™ Battery Powered Infrared Sensor for automatic "No Hands" operation
- Dual Filtered By-Pass
- Diaphragm, Stop Seat and Vacuum Breaker to be molded from PERMEX™ rubber compound for Chloramine resistance

----- Chrome Plated, Die Cast Metal Cover Assembly with Tempered Glass Window

- User friendly 3 second Flush delay
- Courtesy Flush™ Over-ride Button
- Four (4) size AA Batteries included
- "Low Battery" Flashing LED
- Infrared Sensor Range Adjustment Screw
- Initial Set-Up Range Indicator Light (first 10 minutes)
- Solid Handle Cap
- 1" I.P.S. Screwdriver Bak-Chek™ Angle Stop
- Free Spinning Vandal Resistant Stop Cap
- Sweat Solder Adapter with Cover Tube and Cast Set Screw Wall Flange
- Adjustable Tailpiece
- High Back Pressure Vacuum Breaker Flush Connection with One-piece Bottom Hex Coupling Nut
- Spud Coupling and Flange for 1/2" Top Spud

Valve Body, Tailpiece and Control Stop shall be in conformance with ASTM Alloy Classification for Semi-Red Brass. Valve shall be in compliance with the applicable sections of ASSE 1037, ANS/ASME A 112.19.6 and Military Specification V-29193. Valve shall conform to A.O.A. requirements.

..... Variations

D LH Less Handle Opening

See Accessories Section and Optima Accessories Section of the Sloan catalog for details on these and other Optima Plus Flushometer variations

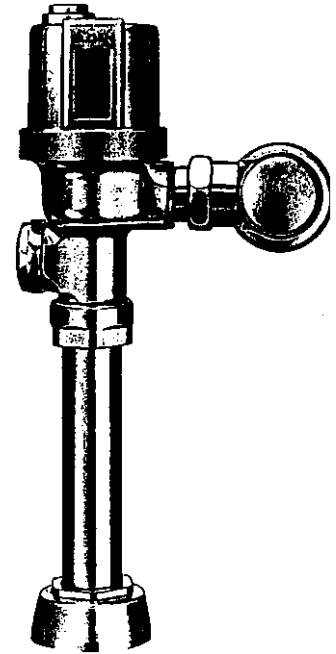

ADA Compliant

.... Automatic

Sloan OPTIMA Plus' equipped Flushometers provide the ultimate in sanitary protection and automatic operation. There is no need for AC hookups or wall alterations. The Flushometer operates by means of a battery powered infrared sensor. Once the user enters the sensor's effective range and then steps away, the Flushometer Solenoid initiates the flushing cycle to flush the fixture.

Hygienic

User makes no physical contact with the Flushometer surface except to initiate the Over-ride Button when required. Helps to control the spread of infectious diseases.

.... Economical

Automatic operation provides savings in water usage over other flushing devices. Reduces maintenance and operation costs.

Warranty

3 year (limited)

Made in the U.S.A.

® Listed

@ Listed

The information contained in this document is subject to change without notice.

This space for Architect/Engineer approval	
Job Name _____	Date _____
Model Specified _____	Quantity _____
Variations Specified _____	
Customer/wholesaler _____	
Contractor _____	
Architect _____	

8110-MC 8111-MC

Description

Exposed, Battery Powered, Sensor Operated Royal Water Closet Flushometer with Metal Cover, for floor mounted or wall hung top spud bowls.

Flush Cycle

- Model 8110-MC Water Saver (3.5 gpf/13.2 Lpf)
- Model 8111-MC Low Consumption (1.6 gpf/6.0 Lpf)

ELECTRICAL SPECIFICATIONS

- Control Circuit
 - Solid State
 - 6 VDC Input
 - 8 sec. Arming Delay
 - 3 sec. Flush Delay
 - 24 Hour Sentinel Flush
- OPTIMA Sensor Type
 - Active Infrared
- OPTIMA Sensor Range
 - Nominal 22"-42" (559-1067mm),
 - adjustable ± 8" (203mm)
- Battery Type
 - (4) AA Alkaline
- Battery Life
 - 3 years @ 4,000 flushes/month
- Indicator Lights
 - Range Adjustment/Low Battery
- Sentinel Flush
 - Once every 24 hours after the last flush

21 1/8" MIN.
(57mm)

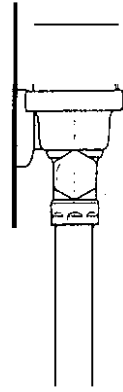

1S11t
(287mm)

C/L OF
FIXTURE

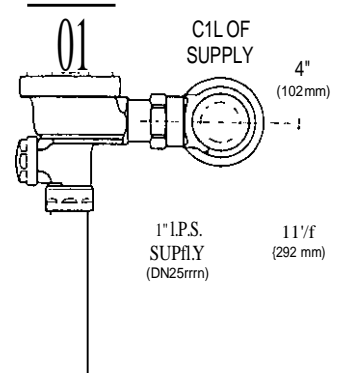

1" I.P.S.
SUPPLY
(DN25mm)

4"
(102mm)

1 1/8"
(292mm)

C/L OF
FIXTURE

OPERATION

1. A continuous, invisible light beam is emitted from the OPTIMA Plus Sensor.

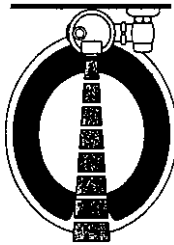

2. As the user enters the beam's effective range (22" to 42") the beam is reflected into the OPTIMA Plus' Scanner Window and transformed into a low voltage electrical circuit. Once activated, the Output Circuit continues in a "hold" mode for as long as the user remains within the effective range of the Sensor,

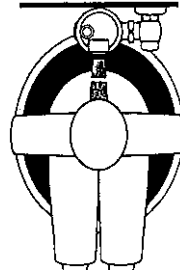

3. When the user steps away from the OPTIMA Plus Sensor, the circuit waits 3 seconds (to prevent false flushing) then initiates an electrical signal that operates the Solenoid. This initiates the flushing cycle to flush the fixture. The Circuit then auto-matically resets and is ready for the next user.

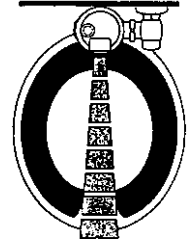

VARIATIONS

OLH
LESS HANDLE
OPENING

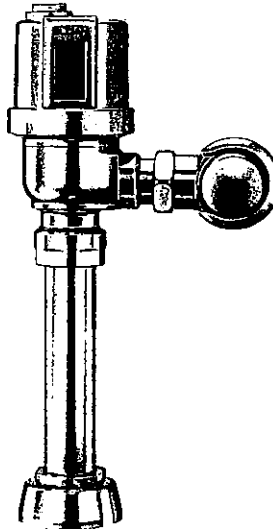

SLOAN

OPTIMA SYSTEMS

Royal® **OPTIMA** p'fu
 Model Battery Powered Flushometers

8186
 8186-1.0
 8186-0.5

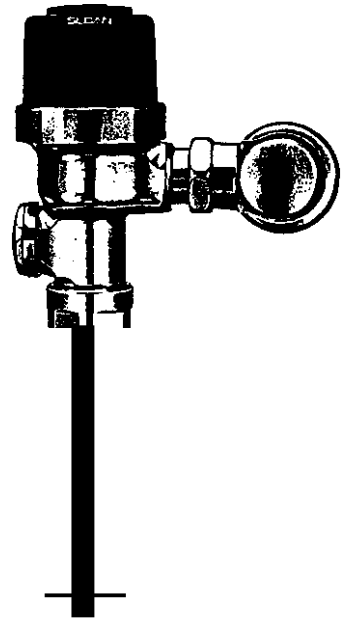

Description
 Exposed. Battery Powered, Sensor Operated Royal Urinal Flushometer.

Flush Cycle
 D Model 8186 Water Saver (1.5 gpf/5.7 LpD)
 D Model 8186-1.0 Low Consumption (1.0 gpf/3.8 LpD)
 D Model 8186-0.5 (0.5 gpf/1.9 LpD)

Specifications
 Quiet, Exposed, Diaphragm Type, Chrome Plated Urinal Flushometer for either left or right hand supply with the following features:

- ADA Compliant OptimaPLUS Battery Powered Infrared Sensor for automatic "No Hands" operation
- Dual Filtered By-Pass
- Diaphragm, Stop Seat and Vacuum Breaker to be molded from PERMEX™ rubber compound for Chloramine resistance
- Engineered Plastic Cover Assembly with Integral Window
- Four (4) size AA Batteries included
- "Low Battery" Flashing LED
- Infrared Sensor Range Adjustment Screw
- Initial Set-Up Range Indicator Light (first 10 minutes)
- Solid Handle Cap
- 3/4" LP.S. Screwdriver Bak-Chek™ Angle Stop
- Free Spinning Vandal Resistant Stop Cap
- Sweat Solder Adapter with Cover Tube and Cast Set Screw Wall Flange
- Adjustable Tailpiece
- High Back Pressure Vacuum Breaker Flush Connection with One-piece Bottom Hex Coupting Nut
- Spud Coupling and Flange for 3/4" Top Spud

Valve Body, Tailpiece and Control Stop shall be in conformance with ASTM Alloy Classification for Semi-Red Brass. Valve shall be in compliance with the applicable sections of ASSE 1037, ANSI/ASME A112.19.6 and Military Specification V-29193. Valve shall conform to A.O.A. requirements.

Variations
 BO Beam Deflector (for targeting small children and wheelchair users)
 LH Less Handle Opening
 MC Metal Cover

See Accessories Section and Optima Accessories Section of the Sloan catalog for details on these and other Optima Plus Flushometer variations.

ADA Compliant

Automatic
 Sloan OPTIMA Plus equipped Flushometers provide the ultimate in sanitary protection and automatic operation. There is no need for AC hookups or wall alterations. The Flushometer operates by means of a battery powered infrared sensor. Once the user enters the sensor's effective range and then steps away, the Flushometer Solenoid initiates the flushing cycle to flush the fixture.

Hygienic
 User makes no physical contact with the Flushometer surface. Helps to control the spread of infectious diseases.

Economical
 Automatic operation provides savings in water usage over other flushing devices. Reduces maintenance and operation costs.

Warranty
 3 year (limited)

Made in the U.S.A.

® Listed @ Listed

Title information contained in this document is subject to change without notice.

This space for Architect/Engineer approval

Job Name _____ Date _____

00

Customer/Wholesaler _____
 Contractor _____
 Architect _____

8186
8186-1.0
8186-0.5

..... Description
Exposed, Battery Powered, Sensor Operated Royal Urinal Flushometer.

Flush Cycle

- D Model 8186 Water Saver (1.5 gpf/5.7 Lpf)
- D Model 8186-1.0 Low Consumption (1.0 gpf/3.8 Lpf)
- O Model 8186-0.5 (0.5 gpf/1.9 Lpf)

2Yf MIN.
(57 mml)

4l
(12lmm)

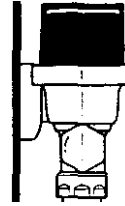

15V2"
(394 mm)



C/LOF
FIXTURE

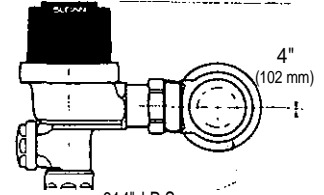

314" I.P.S.
SUPPLY
(ON20mm)

4"
(102 mm)

11 1/2"
(292 mm)

C/LOF
SUPPLY

C/LOF
FIXTURE

ELECTRICAL SPECIFICATIONS

- | | |
|--|--|
| Control Circuit
Solid State
e VOE Input
8 sec. Arming Delay
24 Hour Sentinel Flush | Battery Type
(4) AA Alkaline |
| OPTIMA Sensor Type
Active Infrared | Battery Life
3 years @ 4,000 flushes/month |
| OPTIMA Sensor Range
Nominal 15"-30" (381-762mm),
adjustable ±8" (203mm) | Indicator Lights
Range Adjustment/Low Battery |
| | Sentinel Flush
Once every 24 hours after the last flush |

OPERATION

1. A continuous, invisible light beam is emitted from the TIMA Plus Sensor.

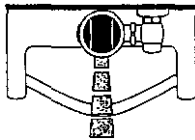

2. As the user enters the beam's effective range (15" to 30") the beam is reflected into the OPTIMA Plus' Scanner Window and transformed into a low voltage electrical circuit. Once activated, the Output Circuit continues in a "hold" mode for as long as the user remains within the effective range of the Sensor.

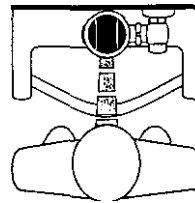

3. When the user steps away from the OPTIMA Plus Sensor, the Sensor initiates an electrical signal that operates the Solenoid. This initiates the flushing cycle to flush the fixture. The Circuit then automatically resets and is ready for the next user.

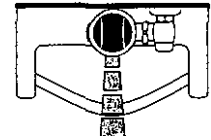

VARIATIONS

DBO
BEAM
DEFLECTOR

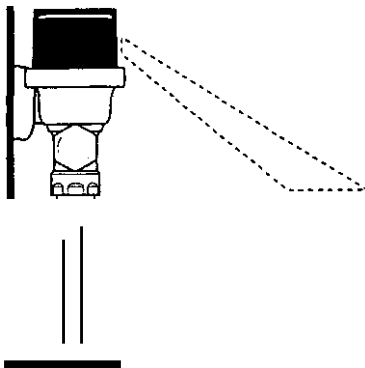

Use when targeting small children and wheelchair users.

DLH
LESS HANDLE
OPENING

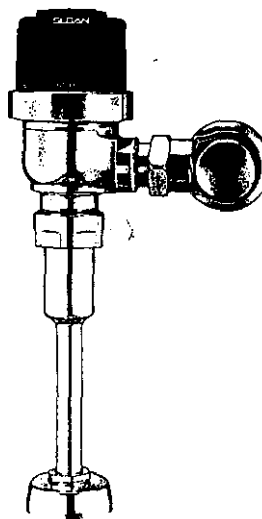

DMC
METAL COVER

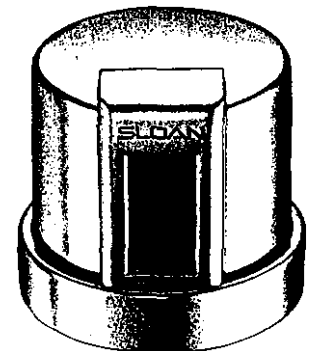

RESS-C-4.5-MC RESS-C-3.5-MC RESS-C-1.6-MC

..... Description
Battery Powered. Sensor Operated Retro Fit Conversion Kit for Exposed Closet Flushometers.

Flush Cycle

- D Model RESS-C-4.5 MC (4.5 gpf/17 LpQ)
- O Model RESS-C-3.5 MC (Water Saver 3.5 gpf/13.2 LpQ)
- O Model RESS-C-1.6 MC (low Consumption 1.6 gpf/6.0 LpD)

ELECTRICAL SPECIFICATIONS

- | | |
|--|--|
| Control Circuit | Battery Life |
| Solid State | 3 years @ 4,000 flushes/month |
| 6 vdc Input | |
| 8 sec. Arming Delay | Indicator Lights |
| 3 second Flush Delay | Range Adjustment/Low Battery |
| 24 Hour Sentinel Flush | |
| OPTIMA Sensor Type | Sentinel Flush |
| Active Infrared | Once every 24 hours after the last flush |
| OPTIMA Sensor Range | Operating Pressure |
| Nominal 22"-42" (559-1,067mm), adjustable ± 8" (203mm) | 15-100 PSI (104-689 kPa) |
| Battery Type | |
| (4) AA Alkaline | |

OPERATION

..... Continuous, invisible light beam is emitted from the OPTIMA Plus Sensor.

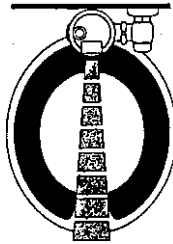

2. As the user enters the beam's effective range (22" to 42") the beam is reflected into the OPTIMA Plus' Scanner Window and transformed into a low voltage electrical circuit. Once activated, the Output Circuit continues in a "hold" mode for as long as the user remains within the effective range of the Sensor.

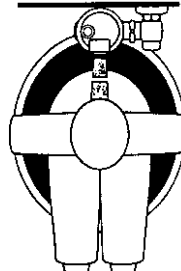

3. When the user steps away from the OPTIMA Plus Sensor, the circuit waits 3 seconds (to prevent false flushing) then initiates an electrical signal that operates the Solenoid. This initiates the flushing cycle to flush the fixture. The Circuit then auto-matically resets and is ready for the next user.

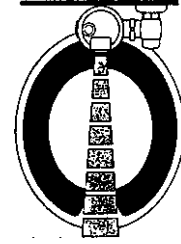

ROUGH-IN

(on existing Sloan Model 110/111 Flushometer)

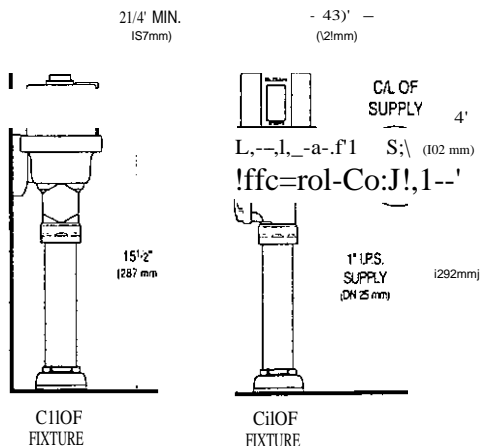

* Typical Water Supply Rough-in dimensions of existing Sloan Model 110/111 Flushometer.

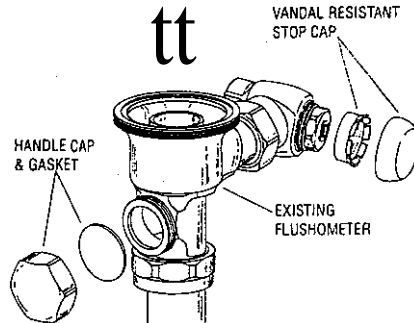
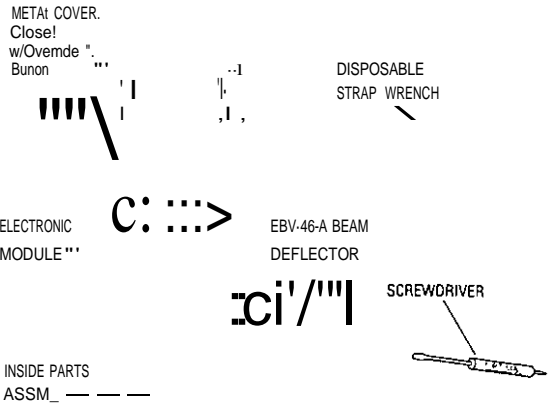

VARIATIONS

D BO
BEAM DEFLECTOR

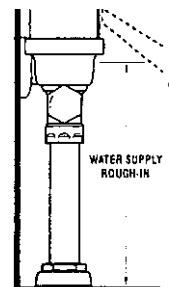

Specify when water supply rough-in is greater than 16" (406 mm) above the top of the bowl.

SLOAN®

OPTIMA SYSTEMS

OPTIM

p'li:u

Battery Powered Urinal Retro Fit

RESS-U-3.5-MC
 RESS-U-1.5-MC
 RESS-U-1.0-MC
 RESS-U-0.5-MC

Description

Battery Powered, Sensor Operated Retro Fit Conversion Kit for Exposed Urinal Flushometers.

Flush Cycle

- Ø Model RESS-U-3.5 MC (3.5 gpf/13.2 Lpn
- Ø Model RESS-U-1.5 MC (Water Saver 1.5 gpf/5.7 Lpn
- Ø Model RESS-U-1.0 MC (Low Consumption 1.0 gpf/3.8 Lpn
- Ø Model RESS-U-0.5 MC (0.5 gpf/1.9 LpD

Specifications

Quiet. Exposed, OPTIMA Plus, Battery Powered, Sensor Operated Urinal Flushometer Retro Fit Conversion Kit for Sloan Royal® and Regal® Flushometers with the following features:

- ADA Compliant OptimaPLLJS™ Battery Powered Infrared Sensor for automatic "No Hands" operation
- Inside Parts Kit with Dual Filtered By-Pass
- Diaphragm to be molded from PERMEX™ rubber compound for Chloramine resistance
- Chrome Plated Die Cast Metal Cover Assembly with Tempered Glass Window
- Four (4) size AA Batteries included
- "Low Battery" Flashing LED
- Infrared Sensor Range Adjustment Screw
- Initial Set-Up Range Indicator Light (first 10 minutes)
- Free Spinning, Vandal Resistant Stop Cap for Sloan H-600 SeriesControl Stop
- Chrome Plated Metal Handle Cap
- Installation Tools provided

Variations

- DBO Beam Deflector (for targeting small children and wheelchair users)
- DZ Locking Ring for Zurn! Flush Valve bodies

See Accessories Section and Optima Accessories Section of the Sloan catalog for details on these and other Optima Plus Flushometer variations.

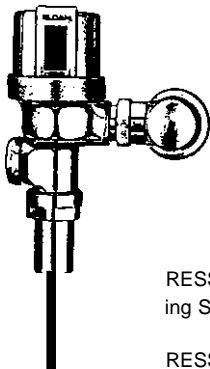

RESS-LI-MC shown installed on an existing Sloan Flushometer.

RESS-LI-MC units do NOT include a Valve Body, Supply Stop, or Vacuum Breaker.

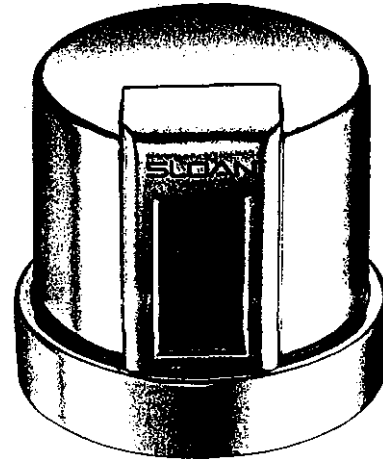

... ADA Compliant

*** Automatic
 Sloan OPTIMA Plus equipped Flushometers provide the ultimate in sanitary protection and automatic operation. There is no need for AC hookups or wall alterations. The Flushometer operates by means of a battery powered infrared sensor. Once the user enters the sensor's effective range and then steps away, the Flushometer Solenoid initiates the flushing cycle to flush the fixture.

Hygienic
 User makes no physical contact with the Flushometer surface. Helps to control the spread of infectious diseases.

Economical
 Automatic operation provides savings in water usage over other flushing devices. Reduces maintenance and operation costs.

Warranty
 3 year (limited)

Made in the U.S.A.

® Listed

® listed

The information contained in this document is subject to change without notice.

This space for Architect/Engineer approval

Job Name _____ Date _____

Model Specified _____ Quantity _____

Variations Specified _____

Customer (Wholesaler) _____

Contractor _____

Architect _____

RESS-U-3.5-MC RESS-U-1.5-MC RESS-U-1.0-MC RESS-U-0.5-MC

Description

Battery Powered, Sensor Operated Retro Fit Conversion Kit for Exposed Urinal Flushometers.

Flush Cycle

Model RESS-U-3.5 MC (3.5 gpf/13.2 LpQ)

Model RESS-U-1.5 MC (Water Saver 1.5 gpf/5.7 Lpf)

Model RESS-U-1.0 MC (Low Consumption 1.0 gpf/3.8 Lpf)

Model RESS-U-0.5 MC (0.5 gpf/1.9 Lpf)

ELECTRICAL SPECIFICATIONS

Control Circuit

Solid State
6 VDC Input
8 sec. Arming Delay
24 Hour Sentinel Flush

Battery Type

(4) AA Alkaline

Battery Life

3 years @ 4,000 flushes/month

Indicator Lights

Range Adjustment/Low Battery

Sentinel Flush

Once every 24 hours after the last flush

Operating Pressure

15-100 PSI (104-689 kPa)

▶ OPTIMA Sensor Type
Active Infrared

▶ OPTIMA Sensor Range
Nominal 15"-30" (381-762mm),
adjustable ± 8" (203mm)

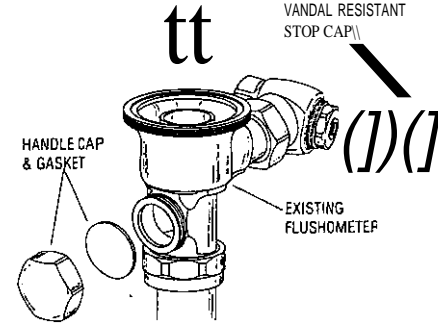
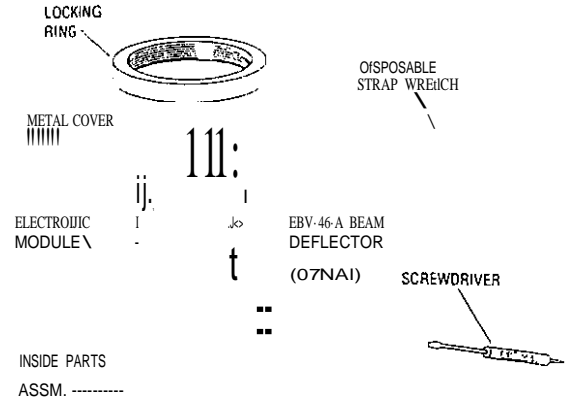

OPERATION

A continuous, invisible light beam is emitted from the OPTIMA Plus Sensor.

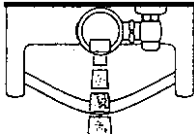

2.

As the user enters the beam's effective range (15" to 30") the beam is reflected into the OPTIMA Plus' Scanner Window and transformed into a low voltage electrical circuit. Once activated, the Output Circuit continues in a "hold" mode for as long as the user remains within the effective range of the Sensor.

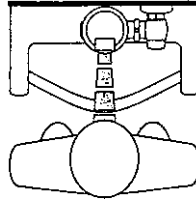

3.

When the user steps away from the OPTIMA Plus Sensor, the Sensor initiates an electrical "one-time" signal that operates the Solenoid. This initiates the flushing cycle to flush the fixture. The Circuit then automatically resets and is ready for the next user.

ROUGH-IN

(on existing Sloan Model 186 Flushometer)

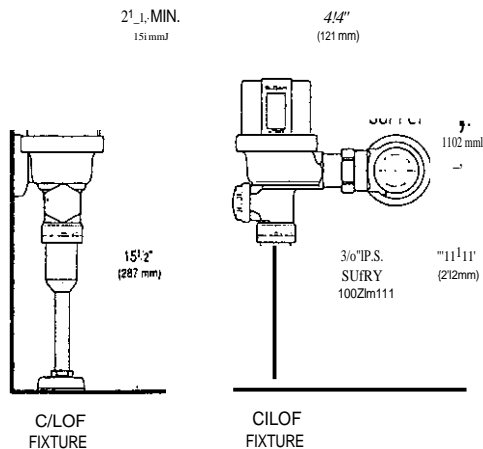

* Typical Water Supply Rough-in dimensions of existing Sloan Model 186 Flushometer.

VARIATIONS

DBO
BEAM DEFLECTOR

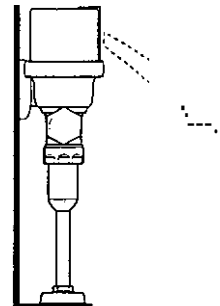

Use when targeting small children and wheelchair users.

WASHBROOK URINAL

- Vitreous china
- Low-consumption (3.8 Lpf/1.0 gpf)
- Flushing rim
- Elongated 14" rim from finished wall
- Washout flush action
- Extended sides for privacy
- 3/4" inlet spud
- Outlet connection threaded 2" inside (NPTF)
- 2 wall hangers
- Fixture only
- Meets ANSI flush requirements at 0.7 to 1.0 GPF

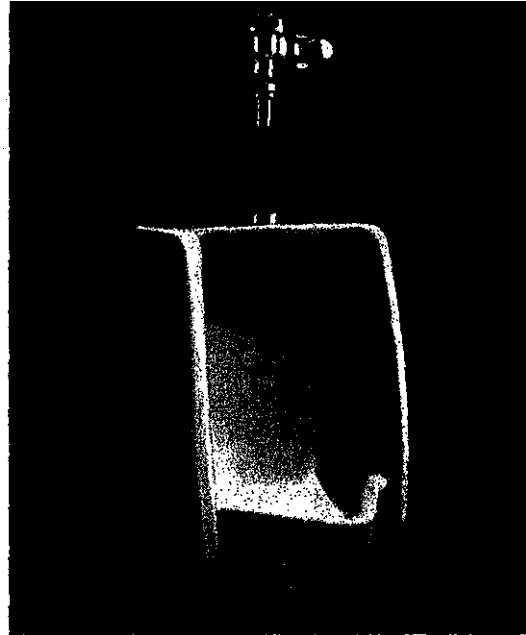

- 0 65010 Top spl.id **MF S Jzicl**
- 0 6506.011 Backspud

Nominal Dimensions:
 470 x 359 x 692mm
 (18-1/2" x 14" x 27-1/4")

Recommended working pressure - between
 20 psi at valve when flushing and 80 psi static.

Compliance Certifications -
 Meets or Exceeds the Following Specifications:
 • ASME A 112.19.2M (and 19.5M) for Vitreous
 China Fixtures - includes Flush Performance,
 Ball Pass Diameter, Trap Seal Depth and
 all Dimension

To Be Specified

- 0 Color: Q White Q Bone Q Silver Q Shell
 Q Black
- 0 Flush Valve: Sloan Royal 186-1 (top spud)
 Sloan Royal 195-1 (back spud)
- 0 Alternative Flush Valve:
- 0 Stainless Steel Strainer: 04706B-0070A

•When installed so top of rim is 387mm (15-1/4") from finished floor.
 MEETS THE AMERICAN DISABILITIES ACT GUIDELINES AND
 ANSI A117.1 ACCESSIBLE AND USEABLE BUILDINGS AND
 FACILITIES - CHECK LOCAL CODES.

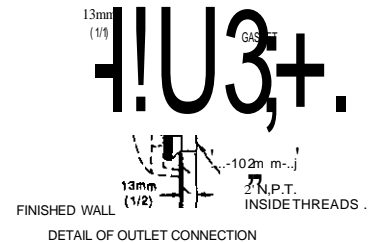
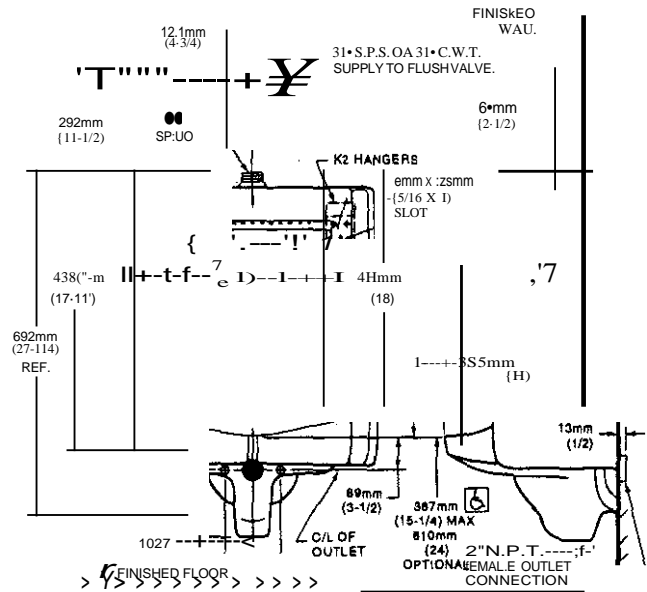

NOTES:
 FLUSH VALVE NOT INCLUDED AND MUST BE ORDERED SEPARATELY,
 PROVIDE SUITABLE REINFORCEMENT FOR ALL WALL SUPPORTS.
 IMPORTANT: Dimensions of fixtures are nominal and may vary within the range of tolerances
 established by ANSI Standard A 112.19.2.
 These measurements are subject to change or cancellation. No responsibility is assumed for use
 of superseded or voided pages.

BARRIER FREE

LUCERNE™ WALL-HUNG LAVATORY

- Vitreous china
- Front overflow
- D-shaped bowl
- Self-draining deck area with contoured back and side splash shields
- Faucet ledge

Faucet holes on 203mm (8") centers (Illus.):

- 0356.028 For exposed bracket support
Shown with .4801.862 Amarelis Heritage faucet with Triune Cross handles (not included)
- 0356.015 For Wall hanger (included) or concealed arms support

Faucet holes on 114mm (4 1/2") centers:

- 0355.02 For wall hanger (included) or concealed arms support

Single center faucet hole (Illus.):

- 0356.041 for exposed bracket support.
Shown with 1340.000 metering faucet (not included).
- 0356.421 for wall hanger (included) or concealed arms support

Nominal Dimensions:

521 x 464mm (20-1/2" x 18-1/4")

Bowl sizes:

381mm (15") wide, 254mm (10") front to back, 171mm (6-3/4") deep

Compliance Certifications:

Meets or Exceeds the Following Specifications:

- ASME A112.19.2M for Vitreous China Fixtures

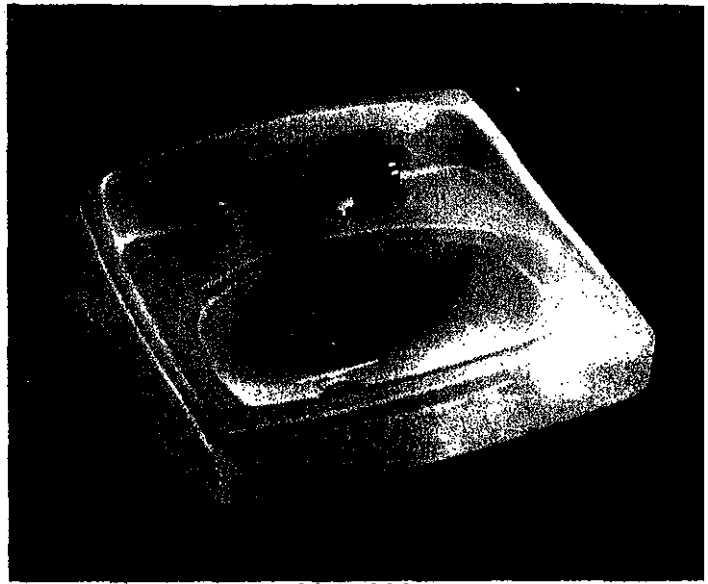

0356,028

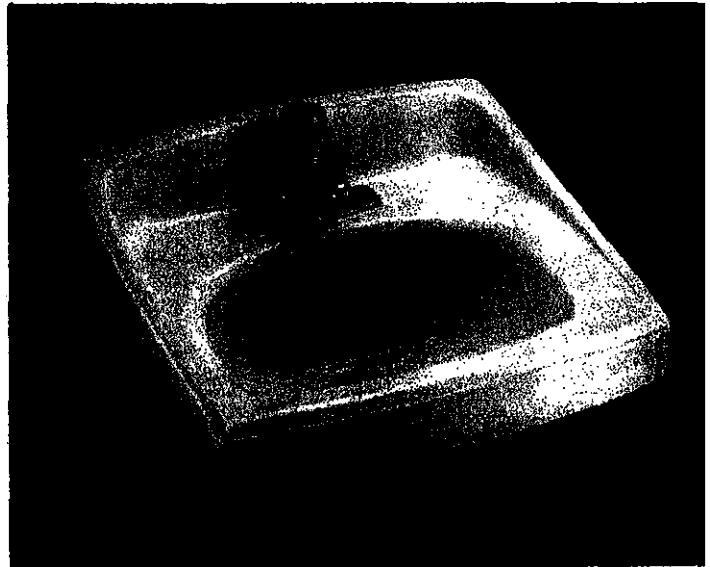

0356.041

To Be Specified

- Color: White Bone Silver Black
- Shell:
- Faucet: Faucet Finish:
- Supplies: 1-1/4" Trap:
- Nipple:
- Bracket Support (by others):
- Concealed Arms Support (by others):

• See faucet section for additional model & available

ril Top of front rim mounted 86Amm (3 1/4") from finished lloOr.
[Q] MEETS THE AMERICAN DISABILITIES ACT GUIDE-
LINES AND ANSI A117. † ACCESSIBLE AND USEABLE
BUILDINGS AND FACILITIES - CHECK LOCAL CODES.

NOTE: Roughing-in information shown on reverse side of page

P7

STANDARD SPECIFICATIONS

These features are common to all Series S19310 units except where indicated with individual model numbers.

Shower Head

10" (254mm) diameter yellow impact-resistant plastic or corrosion-resistant stainless steel.

Shower Valve

Chrome plated brass 1" IPS stay-open ball valve is operated by stainless steel pull rod with triangular handle (except models S19-310HFP and S19310NN).

Eye Wash Bowl

10" (254mm) diameter yellow impact-resistant plastic or corrosion-resistant stainless steel (except models S19-310HFP and S19310GG-no bowls).

Sprayhead Assembly

The integral flow control assures a steady flow under varying water supply conditions.

Standard

Chrome plated brass sprayhead assembly with twin, soft flow, eye wash heads and protective sprayhead covers (Models S19-310, S19-310F, S19-310JJ, S19-310LI, S19-310UU, S19-310JIONN, S19310SC, S19-370DC.)

Face Spray Ring

Chrome plated circular spray ring provides supplemental face spray. Flow control assures adequate flow from eye wash nozzles and face spray ring.

Eye Wash Valve

Chrome plated 1/2" IPS stay-open ball valve, hand operated by stainless steel push flag handle (except models S19-310AC, S19-310GG, S19310LL, S19-310UU, and S19-JTONN).

Pipe and Fittings*

1-1/4" galvanized steel protected with Bradco safety yellow coating (except S19-310JJ).

Water Supply

1-1/4" IPS

*NOTE: Models S19310SC and S19-310SS are all stainless steel

ADDITIONAL FEATURES

Available on certain models.

Hinged Dust Cover

Stainless steel cover keeps contaminants, dust, and debris from eye washing area.

Hand or Foot Operated

Eye wash valve is activated by push flag handle or stainless steel foot pedal. Closes manually by pulling flag handle.

Eye/Face Wash Spray Head

Twin perforated disc eye/face wash heads with protective pop-off spray.



Eye Wash

tt

1. D

2. &

Model 519-310
Plastic Shower Head and Bowl

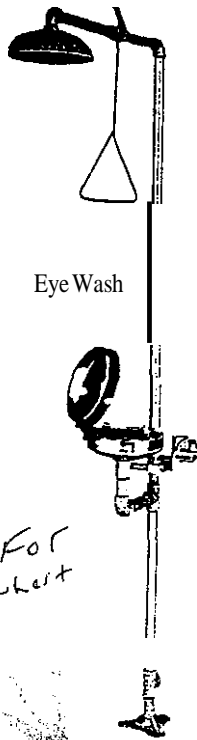

Eye Wash

Use For Leuchert

Model S19-310DOF
Stainless Steel Hinged Dust Cover and Bowl with Plastic Shower Head

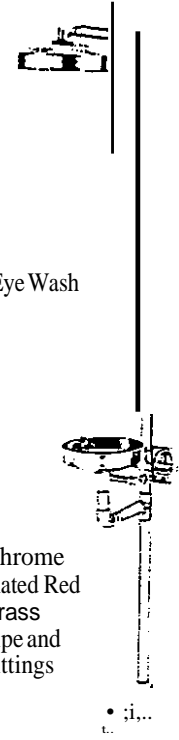

Eye Wash

Chrome Plated Red Brass Pipe and Fittings

Model S19-310JJ
Stainless Steel Shower Head and Bowl Bright mirror finish is superior in laboratory use and in "J" where appearance is Tant.



Eye /Face Wash Spray Heads

Should be model S19-310DC

Stainless steel cover + bowl with plastic shower head

Keep Eye wash clean in work area see Patrick

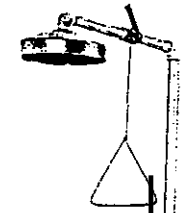

Eye /Face Wash

Model S19-310AC
Plastic Shower Head
Stainless Steel Bowl
Hand or Foot Operated

Model S19-310DCR
Plastic Shower Head
Stainless Steel Hinged Dust Cover

Model S19-310F
Stainless Steel Shower Head and Bowl

pn

Combination SHOWER/EYE WASHES

Standard Specifications

Series 519-310

- Shower head - 10" (254mm) diameter yellow impact-resistant plastic or corrosion-resistant stainless steel. Exceeds minimum water flow: 20 GPM at 30 PSI.
- Eye wash bowl - 10" (254mm) diameter yellow impact-resistant plastic or corrosion-resistant stainless steel.
 - Hinged stainless steel dust cover (available on specified models) covers bowl to keep out contaminants and debris from eye wash area. Dust cover opens when handle is activated.
- Sprayhead assembly: All sprayhead assemblies include flow control to 2.55 GPM, steady water flow: under varying water supply conditions and pop-off protective sprayhead dust covers.
 - Eye wash features chrome-plated brass soft-flow sprayheads designed to gently cleanse the eyes. Exceeds minimum water flow: .4 GPM at 30 PSI.
 - Eye/face wash features ABS plastic perforated disc sprayheads designed to gently cleanse eyes and face. Exceeds minimum water flow: 3 GPM at 30 PSI.
 - Face spray ring features chrome-plated circular spray ring designed with a wider spray pattern for full face spray.
- Shut-off valve - 1" IPS chrome-plated brass stay-open ball valve is operated by stainless steel pullrod with triangular handle.
- Shut-off valve - 1/2" IPS chrome-plated brass stay-open ball valve is operated by a highly visible yellow, PVC or stainless steel (where specified) push handle.
- Pipe - 2" galvanized steel pipe (2" for PVC shower) protected with Bradtect™ yellow coating (unless otherwise specified). Includes 9" diameter floor flange (6" for PVC shower).
- Water supply - 1-1/4" JPS female, 2" IPS (S19-310PVC).
- Waste - 1-1/4" JPS female.
- Compliance - ANS Z358.1-1998.

CERTIFIED
MOOELS
Z358.1-1998

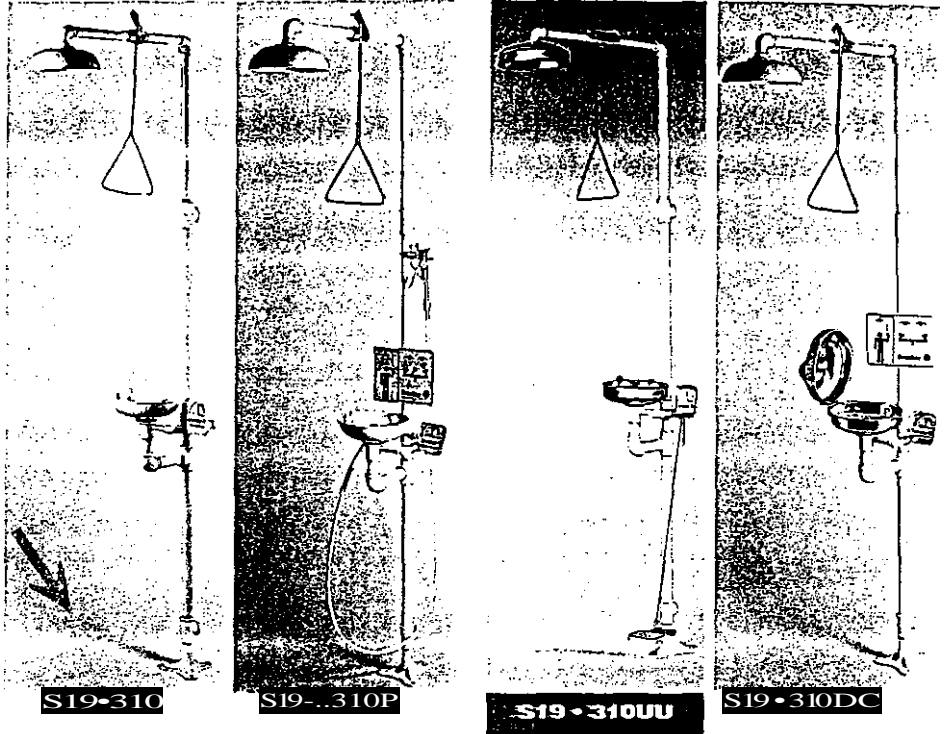

Shower/Eye Wash

Model S19-310 (shown)
Plastic shower head and bowl.

Model S19-310P (shown)
Plastic shower head and bowl. Includes drench hose attachment for face and body rinse.

Model S19-310UU (shown)
Stainless steel shower head and bowl.

Model S19-310DC (shown)
All stainless steel fixture.

Model S19-310J (shown)
Stainless steel shower head and bowl. Chrome-plated red brass pipe and fittings. Bright mirror finish provided for laboratory use and in areas where appearance is important.

Model S19-310SB (shown)
Plastic shower head and stainless steel bowl.

Shower/Eye Wash

Hand or Foot Operated
Model S19-310UU (shown)
Stainless steel shower head and bowl.

Model S19-310CLL (shown)
Plastic shower head and stainless steel bowl.

Shower/Eye Wash

with
Model S19-3100C (shown)
Plastic shower head, stainless steel hinged dust cover, bowl and push handle.

Model S19-310SC (shown)
All stainless steel fixture, hinged dust cover, bowl and push handle.

Optional Attachments

(All combination models)

Model S19-430EH or S19-430SH
Drench hose spray kit. Available for all combination shower and eye wash models - see page 19.

Model 545-572
Foot treadle kit available for pedestal-mount eye washes and combination drench showers/eye washes - see page 19.

Model 545-620
Foot treadle kit for model S19-310PVC shower only - see page 19.

Standard Insulation

ARMAFLEX
INSULATION
SYSTEMS

AP Armaflex®

SUBMITTAL
SHEET



DESCRIPTION

AP Armaflex Pipe Insulation is a flexible elastomeric thermal insulation, black in color, supplied as unslit tubing, in nominal wall thicknesses of 3/8", 1/2", 3/4", and 1", in popular sizes up to 6" IPS. The expanded closed-cell structure of AP Armaflex Pipe Insulation makes it an efficient insulation.

AP Armaflex Pipe Insulation, in 3/8", 1/2", 3/4", and 1" thicknesses has a flame-spread rating of 25 or less and a smoke developed rating of 50 or less as tested by ASTM E 84-91A, "Method of Test for Surface Burning Characteristics of Building Materials."

Numerical flammability ratings alone may not define the performance of products under actual fire conditions. They are provided only for use in the selection of products to meet limits specified.

USES

AP Armaflex Pipe Insulation is used to retard heat gain and control condensation drip from cold-water plumbing, chilled-water, and refrigeration lines. It also efficiently reduces heat flow for hot-water plumbing and liquid-heating and dual-temperature piping. The recommended temperature usage range for AP Armaflex Pipe Insulation is -70°F to +220°F.

For use on cold pipes, AP Armaflex Pipe Insulation thicknesses have been calculated to control condensation on the insulation outer surface, as shown in the following recommendations.

RESISTANCE TO MOISTURE VAPOR FLOW

The closed-cell structure of AP Armaflex Insulation effectively retards the flow of moisture vapor, and AP Armaflex is considered a low-transmittance vapor retarder. AP Armaflex normally requires no supplemental vapor-retarder protection. Additional vapor-retarder protection may be necessary for AP Armaflex when installed on very-low-temperature piping or where exposed to continually high humidity conditions.

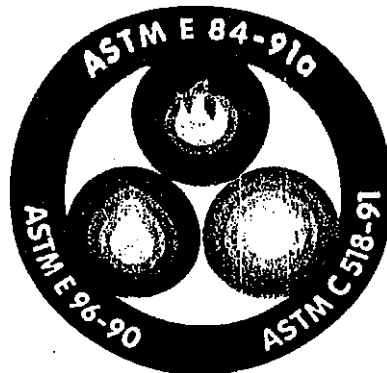

APPLICATION

AP Armaflex Pipe Insulation in unslit tubular form can be slipped onto piping before it is connected, or it can be slit lengthwise and snapped over piping already connected. Fitting covers are fabricated from miter-cut tubular form. In all cases, butt joints and seams are to be sealed with Armstrong 520 Adhesive. 520 Adhesive is a contact adhesive; therefore, in all cases, both surfaces to be joined are coated with adhesive.

AP Armaflex is designed for installation above ground. Indoors, no protective finish is required. If used indoors, a protective finish is recommended. Outdoors, a weather-resistant protective finish is to be applied. The recommended protective finish is Armstrong Armaflex Finish; however, other compatible finish systems are not ruled out.

Armstrong insulation products must be installed according to "Specifications-Installation of Armaflex Insulations," IP-2268. Installation defects and damages in products not installed according to these procedures are not the responsibility of Armstrong.

SPECIFICATION COMPLIANCE

AP Armaflex can be supplied upon request to meet:

- ASTM 0534, Type I Tubular
- ASTM D 1056, 281
- MIL-C-31330 (MIL STD 6708), Grade SBE 3
- MIL-P-15280J, FORM T



ARMSTRONG WORLD INDUSTRIES, INC.
INSULATION PRODUCTS
P.O. BOX 3001
LANCASTER, PA 17604
Phone: 717 396 127
Fax: 717 396-4265

AP Armaflex® Pipe Insulation

Physical Properties	Test Method (See note 3)	
Thermal conductivity, Btu •In.Jh •fp•F 75°F mean temp 90°F mean temp	0.27 0.276	ASTM C 177 or E 518
Water vapor permeability, wet cup, perm-in	0.10	ASTM E 96 Procedure B
Water absorption, % by weight	5	ASTM D 1056
Ozone resistance	GOOD	—
Upper use limit, °F (See note 1)	220	—
Lower use limit, °F (See note 2)	-40 (-70)	—
Size thickness, (nominal)	3/8", 1/2", 3/4", 1"	—
Inside diameter, tubular form	3/8" ID to 6" IPS	—
Length of sections, feet, tubular form	6	—

Notes

¹On the healing cycle, AP Armaflex Pipe Insulation will withstand temperatures as high as 220°F. 520 Adhesive may be used with pipe Insulation applications up to 220°F.

²At -20°F, flexible AP Armaflex Insulation becomes hard and, as temperatures drop below -20°F, will be increasingly brittle; however, this hardening characteristic does not affect thermal efficiency or water vapor permeability. For applications of 40°F to -70°F, contact Armstrong.

³ASTM method, in some cases, may be modified slightly to make results more meaningful for end-use application. If details are required, contact Armstrong.

ARMAFLEX® PIPE INSULATION THICKNESS RECOMMENDATIONS

For Controlling Outer Insulation Surface Condensation
(Based upon available manufactured thicknesses)

Pipe Size	Line Temperatures		
	50°F	35°F	0°F
BASED ON NORMAL DESIGN CONDITIONS* 3/8" ID thru 1-1/8" ID Over 1-1/8" ID thru 2-5/8" ID Over 2-5/8" ID thru 5" IPS	Nom 3/8" Nom 3/8" Nom 1/2"	Nom 1/2" Nom 1/2" Nom 3/4"	Nom 3/4" Nom 1" Nom 1"
BASED ON MILD DESIGN CONDITIONS** 3/8" ID thru 2-5/8" ID Over 2-5/8" ID thru 5" IPS	Nom 3/8" Nom 1/2"	Nom 3/8" Nom 1/2"	Nom 1/2" Nom 1/2"
BASED ON SEVERE DESIGN CONDITIONS*** 3/8" ID thru 5" IPS	Nom 3/4"	Nom 1"	Nom 1-1/2"

NOTE: Nom 1-1/2" is multiple-layer application.

*BASED ON NORMAL DESIGN CONDITIONS AP Armaflex in the thicknesses noted and within the specified temperature ranges will control outer insulation surface condensation indoors under normal design conditions, a maximum severity of 85°F and 70% RH. Armstrong research and field experience indicate that indoor conditions anywhere in the United States seldom exceed this degree of severity.

**BASED ON MILD DESIGN CONDITIONS AP Armaflex in the thicknesses noted and within the specified temperature ranges will control outer insulation surface condensation indoors under mild design conditions, a maximum severity of 50°F and 50% RH. Typical of these conditions are most air-conditioned spaces and arid climates.

***BASED ON SEVERE DESIGN CONDITIONS AP Armaflex in the thicknesses noted and within the specified temperature ranges will control outer insulation surface condensation indoors under severe design conditions, a maximum severity of 90°F and 80% RH. Typical of these conditions are indoor areas in which excessive moisture is introduced or in poorly ventilated confined areas where the temperature may be depressed below ambient.

ALLBROOK® FloWise® 0.5 GPF HIGH EFFICIENCY URINAL SYSTEM

❶ 6550.501 0.5 gpf Exposed Top Spud Urinal & Manual Piston-Type Urinal Flush Valve

URINAL:

- Vitreous china
- High Efficiency (1.9 Lpf/0.5 gpf)
- Flushing rim
- Siphon jet flush action
- 3/4" inlet spud
- Outlet connection threaded 2" inside (NPTF)
- Meets ANSI flush requirements at 0.5 GPF
- Model 6550.001

MANUAL FLUSH VALVE:

- Self-cleaning brass piston with integral wiper spring prevents clogging and reduces maintenance
- Piston operation delivers superior flush accuracy and repeatability
- Piston valve remains closed and does not need to be reset after loss of water pressure
- Non-hold open handle
- Positive seal ensures leak-free performance
- No external volume adjustment
- Durable chrome-plated cast brass construction is ideal for commercial applications
- Chloramine-resistant EPDM seals
- Adjustable tailpiece for rough-in flexibility
- Can be installed left or right hand
- Model 6045.051

Includes:

- Wall hanger
- 3/4" I.P.S. angle stop with back-flow prevention and vandal-resistant cap
- Sweat solder kit including cover tube and wall flange
- High back pressure vacuum breaker with down tube
- Spud coupling & flange for 3/4" top spud

To Be Specified:

Color: White

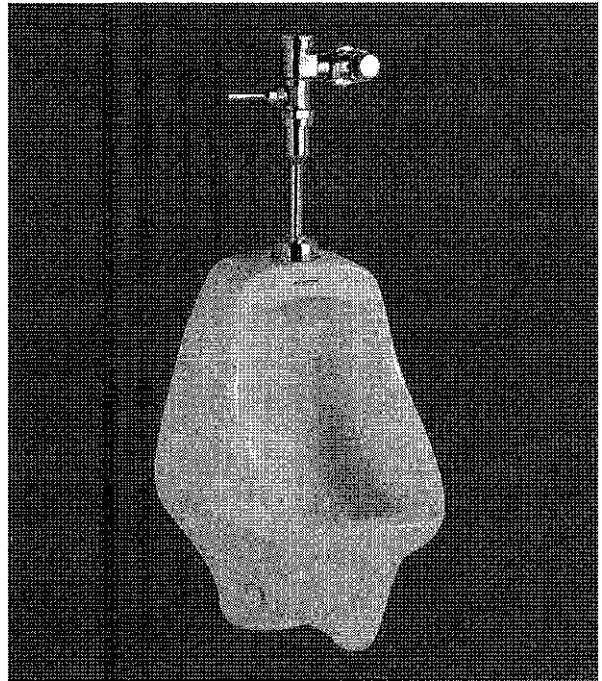

SEE REVERSE FOR ROUGHING-IN DIMENSIONS

Operating Pressure:

Overall Range: 20-125 psi.

Recommended: 20 psi (flowing)-80 psi (static)

- Water pressure over 80 psi is not recommended for most plumbing fixtures.

Flow Requirement:

10gpm (37.9 L/min.)

Nominal Fixture Dimensions:

356 x 363 x 546mm (14" x 14-5/16" x 21-1/2")

Fixture Compliance Certifications -

Meets or Exceeds the Following Specifications:

- ASME A112.19.2-2008/CSA 845.1-08 for Vitreous China Fixtures

Valve Listings:

- ASSE 1037
- ANSI/ASME A112.19.2
- ADA Compliant

ril MEETS THE AMERICANS WITH DISABILITIES ACT GUIDELINES
LQj AND ANSI A117.1 ACCESSIBLE AND USEABLE BUILDINGS AND
FACILITIES - CHECK LOCAL CODES.
• When installed so top of rim is 432mm (17") from finished floor.



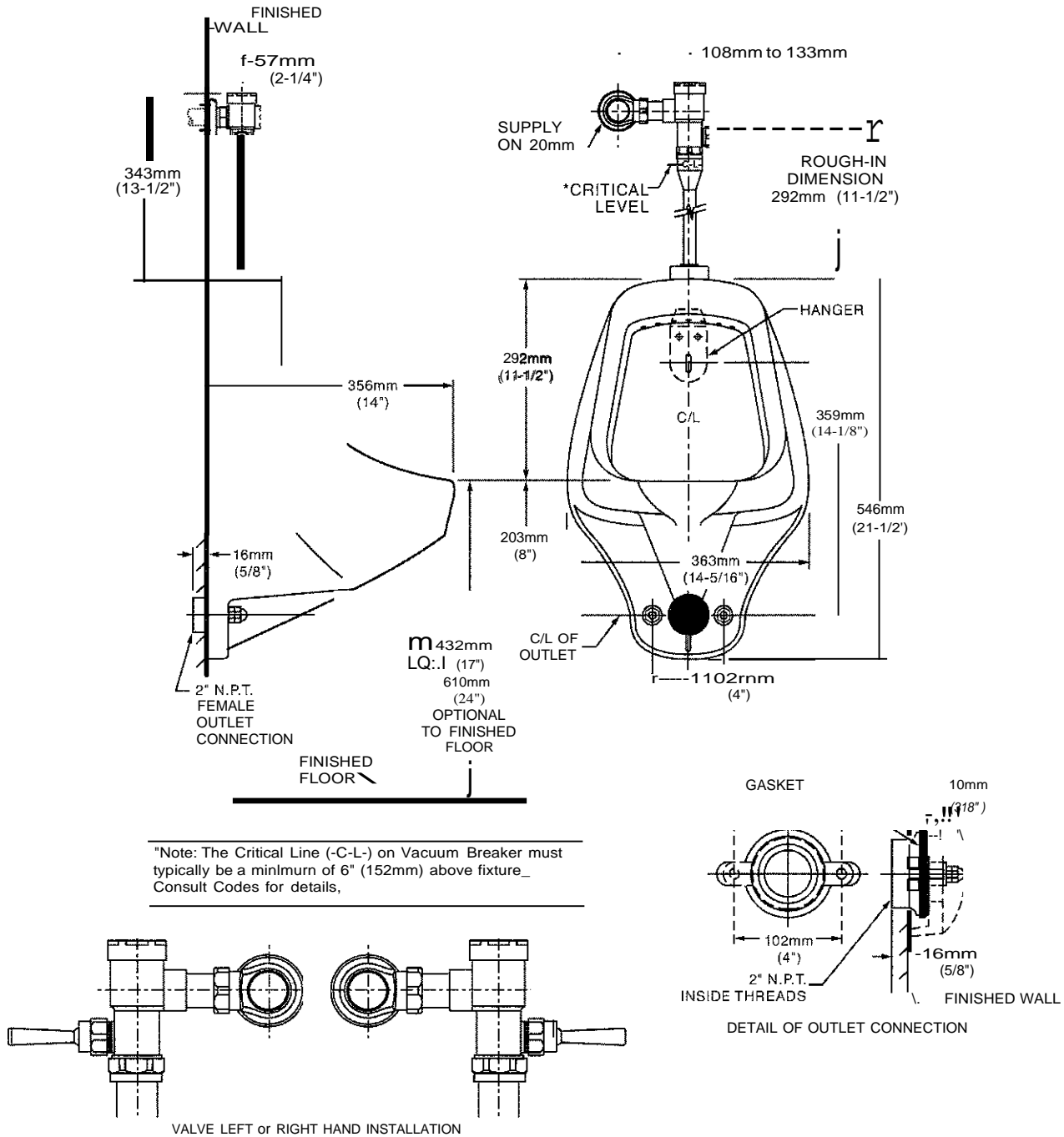

NOTES:
PROVIDE SUITABLE REINFORCEMENT FOR ALL WALL SUPPORTS.

IMPORTANT: Dimensions of fixtures are nominal and may vary within the range of tolerances established by ANSI Standard A112.19.2. These measurements are subject to change or cancellation. No responsibility is assumed for use of superseded or voided pages.



BARRIER FREE

AFWALL® MILLENNIUM™ FloWise® ELONGATED FLUSHOMETER TOILET VITREOUS CHINA with EVERCLEAN®

AFWALL® MILLENNIUM™ FloWise® ELONGATED FLUSHOMETER TOILET with EVERCLEAN®

- Wall-mounted flushometer valve toilet
- Vitreous china
- High Efficiency, Low Consumption. Operates in the range of 1.1 gpf to 1.6 gpf (4.2 Lpf to 6.0 Lpf)
- Meets definition of HET (High Efficiency Toilet) when used with a high efficiency flush valve (1.1 gpf - 1.6 gpf or 1.28/1.1 gpf dual flush)
- Maximum Performance (MaP) score of 1,000 grams at 1.1 gpf - 1.6 gpf
- Permanent EverClean® antimicrobial surface inhibits the growth of stain- and odor-causing bacteria, mold, and mildew on the surface
- Condensation channel
- Concealed trapway design
- Elongated bowl
- Powerful direct-fed siphon jet action
- 1-1/2" inlet spud
- Fully-glazed 2-1/8" trapway
- 10" x 12" water surface area
- Static weight load of 1,000 lbs:
- 100% factory flush tested

- 3351.101 Elongated bowl only, top spud
- 3352.101 Elongated bowl only, top spud with slotted rim for bedpan holding
- 3353.101 Elongated bowl only, back spud
- 3354.101 Elongated bowl only, back spud with slotted rim for bedpan holding

System MaP* Score:

- 1,000 grams of miso @ 1.1 gpf to 1.6 gpf when used with an American Standard flush valve

* Maximum Performance (MaP) testing performed by IAPMO R&T Lab. MaP Report conducted by Veritec Consulting, Inc. and Koeller and Company.

Component Parts:

- 047007-0070A Inlet Spud (furnished with bowl)

Nominal Dimensions:

660 x 356 x 381mm
(26" x 14" x 15")

Recommended working pressure-between 25 psi at valve when flushing and 80 psi static

Fixture only, less seat, bolt caps, and flushometer valve

Compliance Certifications -

Meets or Exceeds the Following Specifications:

- ASME A112.19.2/CSA 845.1 for Vitreous China Fixtures

* This product is not recommended for bariatric use.

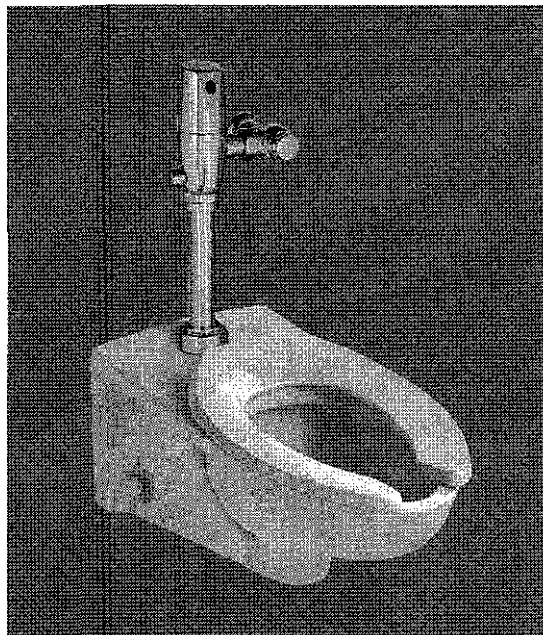

SEE REVERSE FOR ROUGHING-IN DIMENSIONS

To Be Specified:

- Color: ○ White
- Seat:
 - .J American Standard #5901.100 Heavy duty open front less cover
 - CI American Standard #5905.100 Extra heavy duty open front less cover
- CI Flushometer Valve:
 - 1.6 gpf:
 - IJ Sensor-Operated: American Standard Selectronic® DC Power #6065.161.002 (Top Spud) AC Power #6067.161.002 (Top Spud)
 - Manual: American Standard #6047.161.002 (Top Spud)
 - 1.28 gpf:
 - Sensor-Operated: American Standard Selectronic® DC Power #6065.121.002 (Top Spud) AC Power #6067.121.002 (Top Spud)
 - Manual: American Standard #6047.121.002 (Top Spud)
 - 1.6 / 1.1 gpf Dual Flush:
 - Sensor-Operated: American Standard Selectronic® DC Power #6065.761.002 (Top Spud) AC Power #6067.761.002 (Top Spud)
 - 1.28 / 1.1 gpf Dual Flush:
 - D Sensor-Operated: American Standard Selectronic & DC Power #6065.721.002 (Top Spud) AC Power #6067.721.002 (Top Spud)

MEETS THE AMERICANS WITH DISABILITIES ACT GUIDELINES AND ANSI A117.1 REQUIREMENTS FOR ACCESSIBLE AND USABLE BUILDING FACILITIES CHECK LOCAL CODES.

- When installed so top of seat is 432 to 483mm (17" to 19") from the finished floor.

EVERCLEAN®



3351.101/3352.101

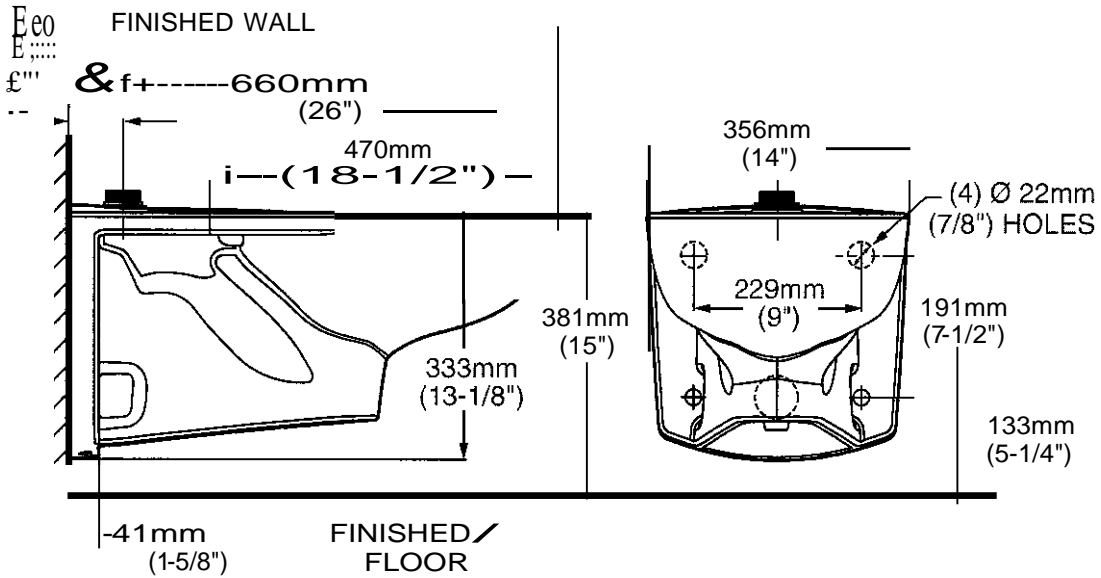

3353.101/3354.101

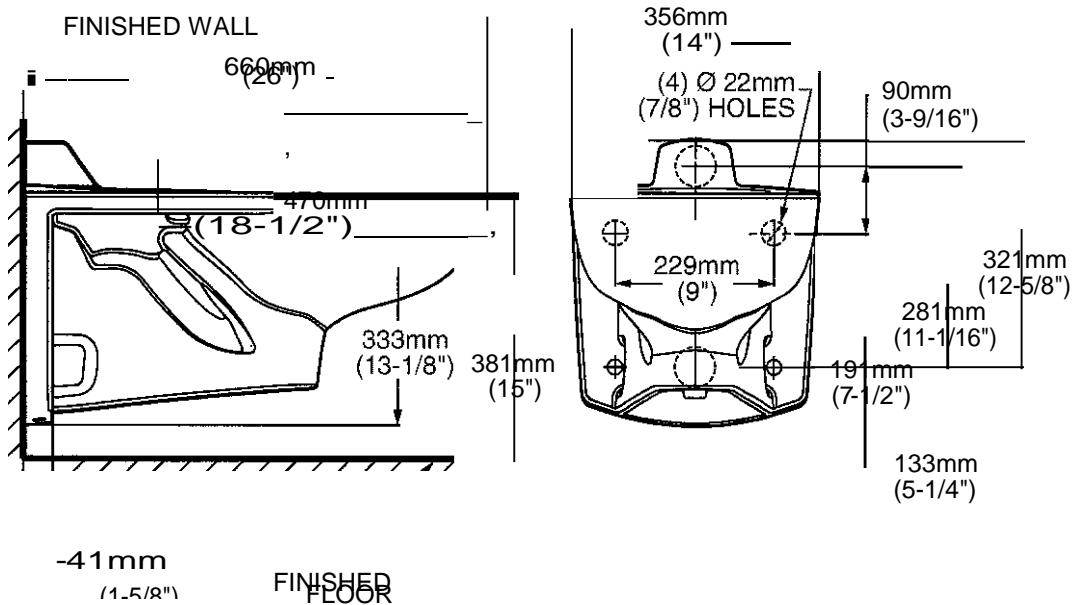

NOTES:

• Toilet designed to meet ADA accessibility standards when top of seat height set at 432 to 483mm {17" to 19"} from finished floor.

PRODUCT 3351 AND 3353 SHOWN, 3352 AND 3354 SAME EXCEPT WITH SLOTTED RIM FOR BED PAN HOLDING.

WASTE OUTLET SEAL RING MUST BE NEOPRENE OR GRAPHITE FELT (WAX RING NOT RECOMMENDED).

SUGGESTED 2mm (1/16") CLEARANCE BETWEEN FACE OF WALL AND BACK OF BOWL.

TO COMPLY WITH AREA CODE GOVERNING THE HEIGHT OF VACUUM BREAKER ON THE FLUSHOMETER VALVE, THE PLUMBER MUST VERIFY DIMENSIONS SHOWN FOR SUPPLY ROUGHING.

FLUSHOMETER VALVE NOT INCLUDED WITH FIXTURE AND MUST BE ORDERED SEPARATELY.

CARRIER FITTING AS REQUIRED TO BE FURNISHED BY OTHERS.

PROVIDE SUITABLE REINFORCEMENT FOR ALL WALL SUPPORT.

IMPORTANT: Dimensions of fixtures are nominal and may vary within the range of tolerances established by ANSI Standard A112.19.2. These measurements are subject to change or cancellation. No responsibility is assumed for use of superseded or voided pages

rlwin

hN-09-01 TUE 12:05 PM

WSC HARRISSBURG

FAX: 71 72331910

PAGE 4

Delta® Single-Handle Lavatory Faucets

- 2 1/2" 3 hole install
- 4 7/8" long spout
- 2.0 gpm @ 60 psi
- 7.1 gpm @ 414 kPa

P!

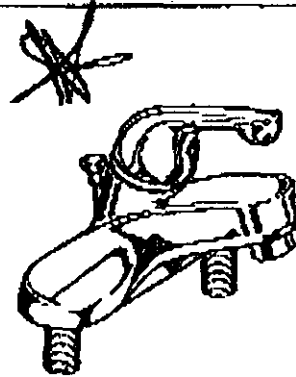

POP-UP DRAIN

Model	Finish	Price	Quantity	Total
Model 1	Chrome	95.15	6	570.90
Model 2	Chrome	99.10	6	594.60
Model 3	Chrome	107.00	6	642.00

Chrome
525-MPU
Metal
129.20
6

STERLI 1'

A KOHLEI

CUR - OU-
SELF-RI
PLANTIL
LAVABO
GABARIT
LAVABO
SANIBEL
SANIBEL¹

15-15116"
(40.5 cm)

18-9/16"
(47.1 cm)

IMPORTANT :
IMPORTANT £ :
IMPORTANT :

The
must

SIZE:
Metric

Dimensions match the dimensions

Size:
Metric

asegurese de que las dimensiones
en con las dimensiones marcadas en la plantilla.

Size:
Metric

chelle, s'assurer que les dimensions
ent avec les dimensions sur le gabarit.

REMARQUE : AVANT DE COUPER !
POUR LES POIGNEES



TERLINGO®

A KOHLER COMPANY

CUT-OUT TEMPLATE
SELF-RIMMING LAVATORY
PLANTILLA DE RECORTE
LAVABO CON BORDE TERMINADO
GABARIT

LAVABO À REBORD INTEGRE

SANIBEL™ 442004- * @

SANIBEL™ 442008- •• - @

15-15/16"
(40.5 cm)

1e dimensions

2e dimensions
mes marquées en la plantilla.

3e dimensions

4e dimensions

**SECTION 120240
DISINFECTION OF WATER LINES**

PART 1 - GENERAL

1.1 Description

- A. Work covered by this Section includes the disinfection of water lines. Any water line which is installed or any water line which is broken into, repaired or replaced shall be flushed and disinfected. Such conditions include, but are not limited to, the following:
 - 1. New Water Mains.
 - 2. New Water Services.
 - 3. Water lines adjacent to points where new hydrants, meters, valves or other appurtenance have been added to an existing water main or service, including the inserted device.
 - 4. New plumbing systems.
 - 5. Portions of existing water mains and services which have been damaged, broken, replaced, repaired or suspected of being contaminated as a result of construction operations.
- B. Definition - "Standard Methods" means the publication "Standard Methods for the Examination of Water and Wastewater," American Public Health Association, latest edition.
- C. All flushing, sampling and testing shall be witnessed by Messiah College 48 hours' notice is required prior to any of this work.

1.2 Quality Assurance

- A. Provide at least one person who shall be present at all times during the execution of this portion of the Work and who is thoroughly familiar with the procedures and methods specified and who shall direct all work performed under this Section.
- B. Comply with all pertinent procedures and requirements of AWWA C651, Federal State and Local laws, regulations and ordinances.
- C. Flushing velocity shall not be less than 2.5 ft./sec.
- D. Flushing of lines shall be done in an approved manner and shall not cause damage to property and structures, nor cause any interference with pedestrian or vehicular traffic.
- E. All laboratory testing shall be performed by one of the following:
 - 1. State Health Department.
 - 2. An approved testing laboratory.
 - 3. Owners laboratory.
 - 4. Contractor (free chlorine residual only - with approved test apparatus).

F. AWWA Standards C651 are made part of these specifications (attached).

1.3 Submittals

- A. Proposed methods and procedures for flushing and disinfecting.
- B. Lab Test results as required under Paragraph FIELD QUALITY CONTROL.
- C. Final certification that all required disinfection has been completed.
- D. Letters of approval from all applicable authorities and utility companies.

PART 2 - PRODUCTS

2.1 Materials

- A. Equipment used during the disinfection of water lines shall be compatible with the form of chlorine used and as recommended by AWWA C651.
- B. Liquid Chlorine - AWWA B301.
- C. Hypochlorites - AWWA B300.
 - 1. Calcium Hypochlorite
 - 2. Sodium Hypochlorite
- D. Sampling Taps - As suggested in AWWA C651.
- E. No granular or tablet allowed.

2.2 Mixes

- A. Chlorine solution shall be of adequate strength to obtain the required chlorine concentration recommended in AWWA C651.

PART 3 - EXECUTION

3.1 Preparation

- A. Prearrange and provide for proper drainage and disposal of the highly chlorinated water used during disinfection and water used for flushing.
- B. Provide feeders, mixers, applicators, sampling taps and other devices required to admit and discharge the flushing water and the chlorine.

3.2 Performance

- A. Thoroughly clean and flush pipes before disinfecting.

- B. Disinfect pipe by one of the methods recommended in AWWA C651 (except Tablet Method Section 5.1).

3.3 Field Quality Control

- A. Perform tests and collect samples in accordance with "Standard Methods".
- B. Collect samples at points indicated in AWWA C651 and where directed by Owner. For plumbing systems, collect samples from at least four individual faucets located on various branches in the system. Take care not to contaminate samples.
- C. Conduct chlorine residual tests to verify that the proper strength chlorine solution is being utilized and that the stipulated chlorine residual is being attained.
- D. Perform Total Coliform tests. If the tests are positive, then re-disinfect the pipe until the tests show an absence of coliform organisms.

3.4 Protection

- A. Protect all disinfected lines from contamination.
- B. Repeat disinfection process on lines that become or may have become re-contaminated and on all lines in which coliform bacteria were found.

** END OF SECTION **

**SECTION 120250
PIPE LEAKAGE TESTING**

PART 1 - GENERAL

- 1.1 Description
- A. This Section covers the requirements for performing leakage tests on pipelines and appurtenances, and is one of the several bases for acceptance of the Work.
 - B. All pressure pipes, non-pressure pipes and appurtenances shall be tested for leakage.
 - C. Definitions:
 - 1. Leakage (or ex-filtration) - The quantity of water to be supplied into the newly laid pipe, any valved section thereof, or other appurtenance, necessary to maintain the specified leakage test pressure after the pipe has been filled with water and the air expelled.
 - 2. Infiltration - The quantity of water which enters into any pipe, or other appurtenance when the static groundwater elevation is at the minimum elevation above the pipe or appurtenance as specified hereinafter.
 - D. All leakage, ex-filtration, infiltration, air and vacuum testing shall be witnessed by Messiah College. 48 hours' notice is required prior to this work being performed.
- 1.2 Quality Assurance
- A. Prior to final acceptance of the Work, all pressure pipes, non-pressure pipes, and appurtenances shall meet specific leakage requirements. These leakage requirements must be satisfied by the basic materials alone. Where joint fillers and the like have been specified, primarily to protect jointing materials, and secondarily to provide a factor of safety, they shall not be applied until after leakage tests have been completed.
 - B. Every test must be witnessed by Owner and any test not so witnessed will be considered as not having been performed. Contractor shall pretest the Work and shall not request Owner to witness the final test until he is reasonably certain that the test will yield results within the acceptable limits.
 - C. No work shall be closed or covered up until it has been duly inspected and approved for proper and satisfactory construction and installation, and compliance with Plans and Specifications. Should incomplete or unapproved work be covered, the Contractor shall, at his own expense, uncover all work so that it may be properly inspected and approved. After such inspection and approval, he shall properly repair and replace all work found defective, unsatisfactory, and not in accord with the Plans and Specifications, and after such repair and replacement, he shall bring all work to the completeness and status as it was before it was closed and covered, all at his own expense.

- D. Successful completion of required tests shall be in no way interpreted as relieving the Contractor of responsibility for defects which become apparent subsequent to the time of testing. It shall be the sole right of the Owner to determine whether defects exist and the Contractor shall retest all portions of the Work deemed necessary by the Owner prior to final approval of the Project.
- E. If defects, leaks, infiltration, or other unacceptable conditions are present or suspected to be present, the Owner may order television inspection of the completed lines in question. Such television inspection shall be performed by the Contractor, solely for the purpose of locating defects, and to minimize the amount of re-excavation necessary to properly locate defects, and effect repairs. No additional compensation will be allowed for television inspection, if ordered, it being understood and agreed that such tests will be ordered only as specified herein and that, if ordered, the costs associated therewith will have been included in the various unit and lump sum prices as bid in the Proposal for the Work.

1.3 Submittals

- A. Complete details and specifications on testing apparatus.
- B. Certified test results on forms approved by Owner. Samples of acceptable forms are attached to this Section.

1.4 Sequencing and Scheduling

- A. Notify Owner at least 48 hours in advance of a scheduled test so that the test may be witnessed.
- B. Test the first 300' of underground gravity sewer as soon as the pipe is laid and prior to backfilling.
- C. Test the first 300' of underground gravity sewers each time a different type of pipe has been used as soon as the pipe is laid and prior to backfilling.
- D. Test the first 300' of underground pressure piping as soon as the pipe is laid and prior to backfilling.
- E. Test the first section of pipe in which there is an adaptor, coupling, lateral connection or other pipe specialty or fitting as soon as pipe is laid and prior to backfilling.
- F. At Owner's discretion, additional sections of pipelines may be required to be tested as soon as pipe is laid and prior to backfilling when working conditions or the standard of workmanship have been altered.
- G. The tests required above in Paragraphs B,C,D,E and F are considered trial tests and only serve the purpose of checking the acceptability of the type of pipe, joint and appurtenances being used and the competence of workmanship of the Contractor's crew in installing them. Successful installation of these first sections will be a prerequisite to further installation by the crew or of the materials.
- H. If any trial test does not fulfill the test requirements, cease installations until the reasons

for failure are determined, the conditions rectified, and the test rerun and satisfactorily passed.

- I. Each trial tested section shall be retested after the backfilling operation is completed before acceptance of the work can be given by Owner.
- J. All testing of underground piping shall be kept current and shall closely follow the work in progress. The maximum permissible period of time between installation and passing the required tests shall be 3 weeks.
- K. All piping shall be tested after all connections, pressure gauges, thermometers and other permanent appurtenances have been installed, except where test pressure may damage them.
- L. No piping shall be insulated, concealed or furred in until it has passed all tests.
- M. Conduct tests on sections of pipe lines between adjacent manholes, valves or chambers as determined by Owner.

PART 2 - MATERIALS

2.1 Testing Apparatus

- A. Provide all labor, pumps, plugs, measuring equipment and other apparatus, complete, and as required to perform all testing.
- B. Provide clean water, air, nitrogen and other materials as required to accomplish all testing.
- C. Provide plugs and caps capable of withstanding the test pressures.
- D. Provide all temporary flanges, plugs, bulkheads, thrust, blocks, weighing, bracing and other items necessary to prevent joints from separating, and to prevent any injuries or damage.

PART 3 - EXECUTION

3.1 Preparation

- A. Pipe Displacement Tests - Provide pipe displacement tests prior to performing leakage tests.
- B. Bracing Pressure Piping - Plug open ends, adequately block bends, tees, ends, and other fittings, and do whatever is necessary to brace the piping system so that it will safely withstand the pressures developed under the tests and so that no damage or injury will occur to the pipeline, people or property.
- C. Protection - Before tests are conducted, isolate or remove any regulator, gauge, trap, or other apparatus or equipment which may be damaged by test pressures.

3.2 General

- A. Trapped Air - Trapped air may cause a false indication of the rate of leakage. Points of concern include ends of lines, stubs, lateral connections and high points in pipelines. No credit will be made for this condition and no adjustment will be made to the allowable leakage. Where trapped air is suspected of causing a test failure, do whatever is necessary to evacuate the air and repeat the tests until the actual leakage is equal to or less than the allowable rate of leakage.

3.3 Tests for Non-Pressure Piping (Except Storm Drains)

A. General

- 1. Air testing is permitted.
- 2. Leakage testing shall include the main non-pressure pipe, lateral connections, and all other appurtenances on the section of pipeline being tested.
- 3. Adequately plug ends of all lateral connections, stubs and all other openings from which air may escape.
- 4. Determine groundwater levels by installing test holes or test pits at intervals not to exceed 1,000'.

B. Vertical Deflection - All PVC gravity sewers shall be tested for vertical deflection.

C. Air Testing of PVC Sanitary Sewer

- 1. The Contractor shall submit details of air testing procedures to the Owner for approval.
- 2. Air testing is to be used for line acceptance; corroborative hydrostatic testing shall be performed on sewer installations of the same pipe size, material and conditions of installation. Sewer sections which indicate the rates of air loss per unit of surface area which most nearly approximate the rate for pipeline acceptance should be selected for the corroborative tests. At least three (3) sections are to be so tested.
- 3. If the air test is not supported by acceptable corroborative hydrostatic tests, complete hydrostatic testing of the sewer lines shall be required as the basis for final pipeline acceptance, in a manner acceptable to the Owner.
- 4. As a safety precaution, pressurizing equipment should include a regulator set at 8 psi to avoid over-pressurizing and damaging an otherwise acceptable line.
- 5. A satisfactory test shall require a time period in excess of that listed in the Table below.
- 6. The Contractor shall also provide a separate certified test gauge for periodic checking of the accuracy of the basic equipment gauges.
- 7. The maximum allowable leakage in the sewer lines shall be 100 gal/mi/24 hr. per inch of internal diameter of the sewer.
- 8. Air test minimum requirements

Minimum Holding Time in minutes required for pressure to drop
1.0 PSIG Pipe

4" Diameter	2-1/2 Minutes
6" Diameter	4 Minutes

8" Diameter	5 Minutes
10" Diameter	6-1/2 Minutes
12" Diameter	7-1/2 Minutes
15" Diameter	9-1/2 Minutes

3.4 Tests for Pressure Pipes

A. General

1. Leakage testing shall include the main pressure pipe, service connections, and all other appurtenances on the section of pipeline being tested.
2. All pipes shall be tested prior to applying insulation and before they are concealed or furred-in.
3. Provide all necessary gauges. Gauges shall be standard pressure type with a minimum 6" diameter dial and a pressure range not in excess of 50% of the maximum required test pressure.
4. Provide and maintain at the site a gauge stand with an approved laboratory calibrated test gauge. Periodically check test gauges used for testing against the test gauge, and whenever requested by Owner.
5. Where it is absolutely necessary for testing, tap pipes and insert approved plugs after testing is completed.
6. Provide a hand or motor driven pump to maintain the required test pressure constant throughout the duration of the test. If a water pump is used, pump water from a container with a known volume of water. If an air or inert gas pump is used, leakage shall be determined and calculated by the cycling of the pump.

B. Underground Pipes

1. Conduct leakage test in accordance with AWWA C600.
2. Tests may be performed with trench partially or totally backfilled.

C. Pipes Carrying Gases

1. In order to secure more accurate test results, allow ample time for the temperature of the gas and piping to stabilize.
2. Provide concentrated liquid soap or a commercial leak detection preparation and use for locating leaks on exposed piping.

3.5 Tests for Storm Drains and Drainage Structures

- A. Structures - Leakage testing of drainage structures is not required. However, visible infiltration into structures is not permitted and shall be stopped when it is found to exist.
- B. Culverts - Leakage testing of culverts is not required, provided that manufacturer provides a certification that pipe and joints have satisfactorily passed factory hydrostatic testing as prescribed in the applicable pipe standards.
- C. Storm Sewers - Leakage testing of storm sewers is not required. However, visible infiltration into storm sewers is not permitted and shall be stopped when encountered.

3.6 Allowable Leakage

- A. It is the intent of this Contract to secure piping systems with leakage, in each section of pipe and within each structure, equal to, or less than that specified. It is also the intent to secure a piping system free from visible drips, streams, and leaks. Therefore, even if a portion of the system meets the requirements for allowable leakage, visible leaks are not permitted and shall be stopped.
- B. Leakage tests will be considered satisfactorily passed when the rate of leakage is equal to or less than the stipulated allowances, there is no evidence of visible leaks, and there is no evidence of other system defects.

3.7 Retesting

- A. Pipes not passing the tests shall have all defects corrected to the satisfaction of Owner, and shall be re-tested and re-corrected as often as is necessary until the test requirements have been met.
- B. It is the intent of this Contract to obtain work meeting test requirements on their own and solely through the use of the normal integral sealing components. Joint leaks shall not be stopped through the use of concrete, caulking, mortar, or other patching materials. Leaking pipe joints shall be rejoined or replaced if necessary.
- C. Methods other than rejoining, resetting or replacing joint seals shall require the written approval of Owner.

3.8 LEAKAGE TESTING REQUIREMENTS

----- TEST -----	ALLOWABLE LEAKAGE ⁽¹⁾				
Gas or	Duration				
ITEM TESTED	Fluid	Pressure	(Time)	Infil	Exfil Exposed
NON-PRESSURE PIPING - SANITARY					
4" Diameter SDR 35 PVC	Air	4 PSI	2.5 Min.	0	1 PSI
6" Diameter SDR 35 PVC	Air	4 PSI	4 Min.	0	1 PSI
8" Diameter SDR 35 PVC	Air	4 PSI	5 Min.	0	1 PSI
10" Diameter SDR 35 PVC	Air	4 PSI	6.5 Min.	0	1 PSI
NON-PRESSURE PIPING - DRAINAGE					
Storm Sewers				-----	No Limit -----
PRESSURE PIPING					
Water Lines	Water	X ⁽²⁾ 3 Hrs.	0	X ⁽²⁾	0
Water Lines (Fire)	Water	X ⁽³⁾ 3 Hrs.	0	X ⁽³⁾	0
STRUCTURES					
Drainage Structures No Visible Leakage					

----- NOTES -----

1. Maximum allowable leakage in gallons / day / inch diameter / mile of pipe, or gallons / day / inch diameter/vertical foot for manholes. Where a percentage is shown, the loss shall not exceed the percentage of the starting test pressure.
2. When pipe has been backfilled, test pressure shall be 50% above the normal operating pressure and shall also meet all requirements of Section 4 of AWWA Specification C-600.
3. When pipe has been backfilled, test pressure shall be 50% above normal operating pressure or 200 PSI, whichever is greater, and shall also meet NFPA-13.

WATER MAIN PRESSURE/LEAKAGE TEST

- A. Location/Description of Line Being Tested
- B. Testing Station Elevation
- C. Maximum Elevation of Line Tested
- D. Elevation Differential
- E. Gage Correction @ Testing Station⁽¹⁾ _____ PSI
- F. System's Working Pressure _____ PSI
- G. System's Test Pressure⁽²⁾ _____ PSI
- H. Corrected Test Pressure & Testing Station⁽³⁾ _____ PSI

Pressure Test⁽⁴⁾

- | | Time | Pressure Reading |
|----|--------------|------------------|
| I. | Start _____ | |
| J. | Finish _____ | |
| | PASS _____ | FAIL _____ |

Leakage Test

- K. Test Pipe Diameter
- L. Test Pipe Length
- M. Allowable Leakage Rate _____ GPH
- N. Actual Leakage _____ Gallons
- O. Test Length _____ Hours

P. Actual Leakage Rate

PASS _____ FAIL

- (1) $E = D \times 0.443 \text{ PSI}$
- (2) $G = F \times 1.50$, but not less than 150.0 PSI or not less than 200.0 PSI if fire line
- (3) $H = G \ \& \ E$
- (4) Pressure Test duration minimum 3 hours
Allowable pressure variation $5 \pm \text{PSI}/2 \text{ hours}$

** END OF SECTION **



Freezeless Commercial Wall Hydrants



Model 65

Model 67



Model
B65/B67
Rectangular
Box & Door



Model
RB65/RB67
Round
Box & Door



Model
MB65/MB67
Composite Box
Stainless Steel
Door & Fascia



Model 68
Undercover
All Hydrant™
Stainless Steel
Down Cover



Model HC65/HC67
Hot & Cold

Model HCB65/HCB67



Note: The Model 70 does not share 65/67 series features. See page 2 for Model 70 specifications.

Woodford Model 65, 67 & 68 series wall hydrants are available as exposed or boxed wall mounted hydrants. Choose single check anti-siphon or dual check backflow protected models as required. Wall hydrants are designed to blend with modern architecture for installation on a wide range of commercial buildings.

- Automatic draining
- Hydrant fits one standard brick course
- Cast brass box models fit two standard brick course
- Wall thickness: 4" - 24" in 2" increments
- 3/4" male hose thread nozzle
- Cast brass round box models fit 6" diameter cored hole
- One piece valve plunger seated in brass valve body
- Copper tube casings
- No lead solder on all solder joints
- Hardened stainless steel stem
- Loose tee key operation
- 3/8" solid brass operating rod
- Chrome finish standard. Other finishes available.
- MAX PRESSURE; 125 p.s.i.
- MAX TEMPERATURE; 120° F

Scan For Specifications,
Installation and
Troubleshooting



For information, please contact:

Freezeless Commercial Wall Hydrants Specifications



When ordering, specify model, Inlet and Wall Thickness.....Example B67C-12

MODEL	SPECIFICATIONS	INLET	FINISH
67	<ul style="list-style-type: none"> Freezeless Wall Hydrant; UPC, cUPC Approved *ASSE 1052 Nidel® 50HA High Flow Double Check Backflow Preventer 	C or P	
B67	<ul style="list-style-type: none"> 67 Freezeless Wall Hydrant Brass Rectangular Box 	C or P	Std: Chrome Opt: Rough Brass (BR) Polished Brass (PB)
RB6	<ul style="list-style-type: none"> 67 Freezeless Wall Hydrant Brass Round Box 	C or P	
HC6	<ul style="list-style-type: none"> 67 Freezeless Wall Hydrant Single Control Hot & Cold Mixer 	3/4" FPT (2)	
HCB67	<ul style="list-style-type: none"> HC67 Freezeless Hot & Cold Mixer Wall Hydrant Rectangular Brass Box & Door 	3/4" FPT (2)	
MB67	<ul style="list-style-type: none"> 67 Freezeless Wall Hydrant Modular Composite Box, Heavy Gauge Stainless Steel Door & Fascia 	C or P	Chrome (Hydrant)
65 ASSE 1019-B	<ul style="list-style-type: none"> Freezeless Wall Hydrant ASSE 1011 Nidel® 34HA Single Check Vacuum Breaker; CSA, UPC Approved 	C or P	
B65 ASSE 1019-B	<ul style="list-style-type: none"> 65 Freezeless Wall Hydrant Rectangular Brass Box 	C or P	Std: Chrome Opt: Rough Brass (BR) Polished Brass (PB)
RB65 ASSE 1019-B	<ul style="list-style-type: none"> 65 Freezeless Wall Hydrant Round Box - Chrome Only 	C or P	
MB65 ASSE 1019-B	<ul style="list-style-type: none"> 65 Freezeless Wall Hydrant Modular Composite Box, Heavy Gauge Stainless Steel Door & Fascia 	C or P	
68 ASSE 1053	<ul style="list-style-type: none"> 68 Freezeless Undercover Wall Hydrant™ Integral Stainless Steel flip-down head cover *ASSE 1052 Nidel® 50HA High Flow Double Check Backflow Preventer 	C or P	Std: Chrome Opt: Rough Brass (BR)
C22	<ul style="list-style-type: none"> Freezeless Hot & Cold Wall Faucet *ASSE 1052 Nidel® 50HA High Flow Double Check Backflow Preventer 	<ul style="list-style-type: none"> **Patented PRV Pressure Relief Valve (both tubes) C, CP, CP3, P, PX, PX3	Chrome
B22	<ul style="list-style-type: none"> C22 Freezeless Hot & Cold Wall Faucet Rectangular Brass Box and Door 	C, CP, CP3, P, PX, PX3	Std: Chrome (CH) Opt: (BR) B22-BR
21	<ul style="list-style-type: none"> Hose Nozzle - No Anti-Siphon Protection Optional Metal Wheel Handle 	<ul style="list-style-type: none"> Std: Polycarbonate Wheel Handle & Tee Key P1/2, P3/4, C, CP	
24	<ul style="list-style-type: none"> ASSE 1011 Nidel® Model 34HF Anti-Siphon Vacuum Breaker; IAPMO® Listed Std: Polycarbonate Wheel Handle & Tee Key Optional Metal Wheel Handle 	P1/2, P3/4, C, CP	
26	<ul style="list-style-type: none"> *ASSE 1052 Nidel® Model 50HF High Flow Double Check Backflow Preventer Std: Polycarbonate Wheel Handle & Tee Key; Optional Metal Wheel Handle 	P1/2, P3/4, C, CP	Std: Chrome (CH) Opt: Rough Brass (BR) Polished Chrome (PC)
B24	<ul style="list-style-type: none"> Model 24 with Brass Box & Door; Tee Key Lock 	P1/2, P3/4	
B26	<ul style="list-style-type: none"> Model 26 with Brass Box & Door; Tee Key Lock 	P1/2, P3/4	
70	<ul style="list-style-type: none"> 3/4" Hose Nozzle - No Anti-Siphon Protection 1" galvanized steel pipe casing Permanent type brass valve body with hemispherical seating surface 	C or P	
MB24-1/2 MB24-3/4	<ul style="list-style-type: none"> Model 24 with Light weight Composite Box, Heavy Gauge Stainless Steel Door & Fascia Tee Key Lock 	P1/2, P3/4	Chrome (CH)
MB24-1/2-K MB24-3/4-K	<ul style="list-style-type: none"> Model 24 with Light weight Composite Box, Heavy Gauge Stainless Steel Door & Fascia Key Cylinder Lock 	P1/2, P3/4	Chrome (CH)
MB26-1/2 MB26-3/4	<ul style="list-style-type: none"> Model 26 with Light weight Composite Box, Heavy Gauge Stainless Steel Door & Fascia Tee Key Lock 	P1/2, P3/4	Chrome (CH)
MB26-1/2-K MB26-3/4-K	<ul style="list-style-type: none"> Model 26 with Light weight Composite Box, Heavy Gauge Stainless Steel Door & Fascia Key Cylinder Lock 	P1/2, P3/4	Chrome (CH)
MB221	<ul style="list-style-type: none"> Hose Nozzle - No Anti-Siphon Protection Light weight Composite Box, Heavy Gauge Stainless Steel Door & Fascia Tee Key Lock; Optional Cylinder Lock (K) 	1/2-14 FPT	Brass Components
MB224	<ul style="list-style-type: none"> ASSE 1011 Nidel® Model 34HF Anti-Siphon Vacuum Breaker; IAPMO® Listed 	1/2-14 FPT	Brass Components
MB226	<ul style="list-style-type: none"> *ASSE 1052 Nidel® Model 50HF High Flow Double Check Backflow Preventer 	1/2-14 FPT	Brass Components

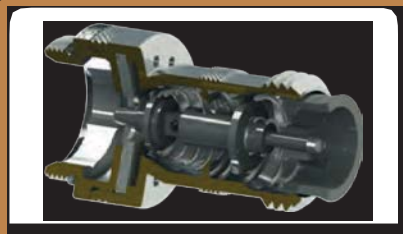

*NIDEL® Model 50 Backfl Preventer

The patented NIDEL® Model 50 high flow double check backflow preventer is standard equipment on specified commercial wall hydrant models. It is intended for irrigation and outdoor watering and is designed to protect hose connections from backflow contamination in freezing and non-freezing conditions. The Model 50 automatically drains when the hose is removed and unlike single check vacuum breakers can be field tested for reliability.

- ASSE 1052 Approved
- High Flow Rate
- Field Testable (see instruction sheet)
- Drains automatically when hose is removed
- Two independent check valves
- No spray back

Freezeless Commercial Wall Hydrants Parts List



MODEL 65/67 & HC65/HC67		
ITEM	PART#	DESCRIPTION
1	50009	Tee Key
	50010	Long Tee Key (Box Models)
	50264	Head Nut - chrome
2	50265	Head Nut - brass
	50583	I.D. Ring
3	50252	Stem Washer
4	55062	Stem Screw
5	50251	"C" Washer
6	51014	Yoke Nut
7	50250	Plunger
8	50HA-CH	NIDEL® 50HA Backflow Preventer - chrome
	50HA-BR	NIDEL® 50HA Backflow Preventer - brass
9	34HA-CH	NIDEL® 34HA Vacuum Breaker - chrome
	34HA-BR	NIDEL® 34HA Vacuum Breaker - brass
10	50559	Handle Screw
11	50547	Handle - brass
	50548	Handle - chrome
12	50545	Locking Nut
	50543	Face Plate - brass
13	50544	Face Plate - chrome
	361XX	HC67 Casing Assembly (Includes Items 16 & Call for assistance)
14	51093	O-Ring AS-023
15	50529	Support Washer
16	51092	O-Ring AS-110
17	5508X	Rod Assembly - Call for assistance
18	5053X	Casing Shield - Call for assistance
19	50500	Mixer Body
20	50502	Gasket (2 required)
21	55079	Shuttle Housing Assembly (2 required)
22	51050	Tamper Proof Screws (6 required)
23	50542	Wall Plate - chrome
24	55063	Wall Clamp Assembly
25	67BX	Box/Door Assembly - Chrome
26	51120	E-Ring
27	51117	Door Lock Screw - Chrome
	51116	Door Lock Screw - Brass
28	RB67BX	Round Box/Door Assembly - Chrome
29	MB65BX	Modular Box/Door Assembly - Chrome
30	50041	Headless Shoulder Bolt (2)
31	30150	Cam Lock Cam Screw
32	30143	Cam Lock
33	30155	Cam Lock Hex Nut
34	50280	Stainless Steel Head Cover
35	30140	Tee Key Lock Well
36	30156	Tee Key Lock Disc Spring
37	30139	Tee Key Lock
38	553XX	HC Operating Rod Assemblies (See chart for Overall Length)
39	RK-65	Chrome Repair Kit (Includes Items 1-8)
	RK-HC	HC/HCB Repair Kit (Includes Items 16-18,22,23)
	RK-38	Cover Repair Kit (Includes Items 32-39)

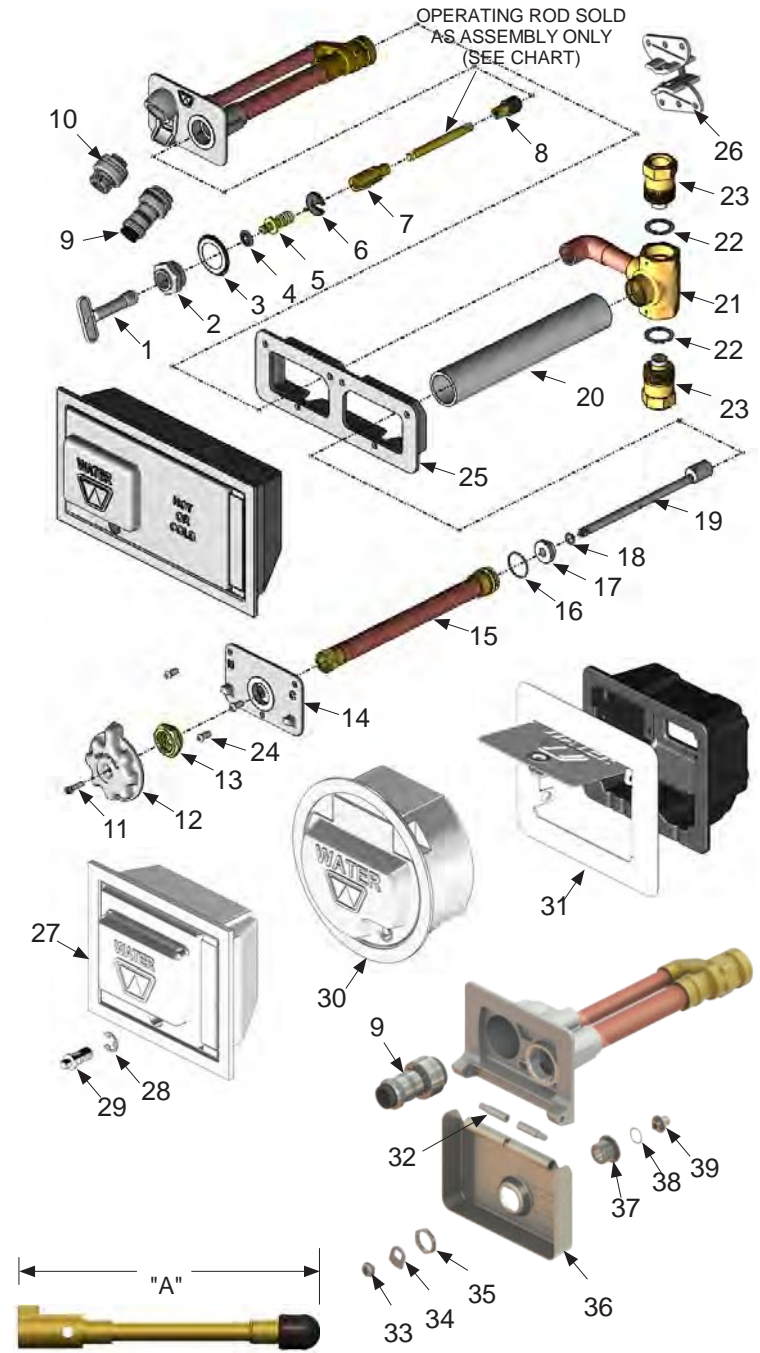

Wall Thickness (Inches)	Overall Length (Inches)	Part No.
67	B67/RB67	
CC	CC	3 ½ 55401
N/A	4	4 ½ 55402
4	6	6 ½ 55404
6	8	8 ½ 55406
8	10	10 ½ 55408
10	12	12 ½ 55410
12	14	14 ½ 55412
14	16	16 ½ 55414
16	18	18 ½ 55416
18	20	20 ½ 55418
20	22	22 ½ 55420
22	24	24 ½ 55422
24	N/A	26 ½ 55424

INLET - Model 65 & 67 Series 4 3/8" Min. Length In Heated Area



Freezeless Commercial Wall Hydrants Rough-In Dimensions

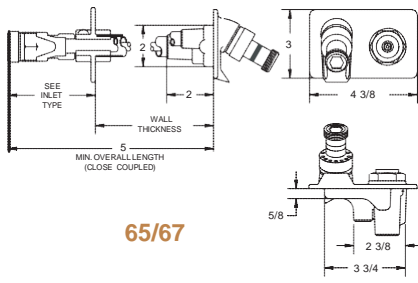

65/67

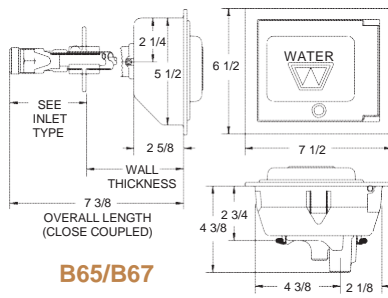

B65/B67

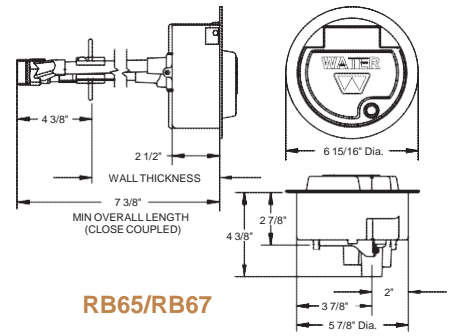

RB65/RB67

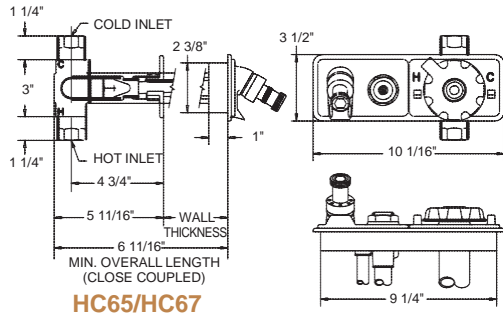

HC65/HC67

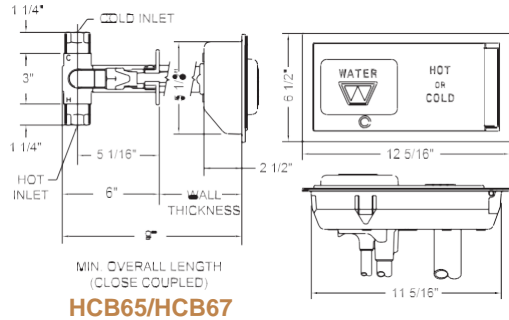

HCB65/HCB67

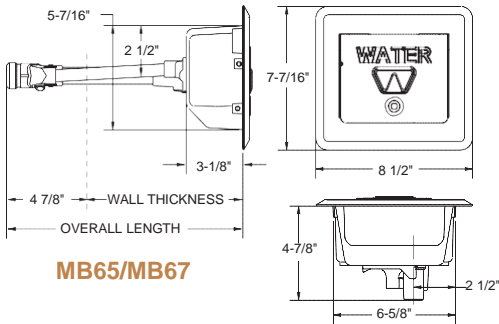

MB65/MB67

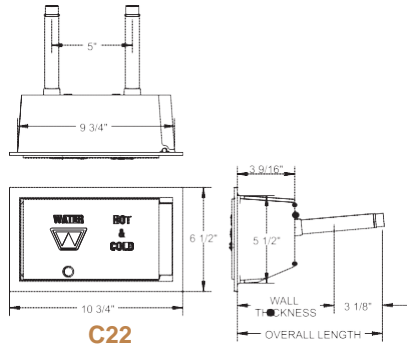

C22

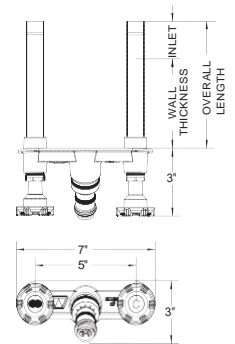

B22

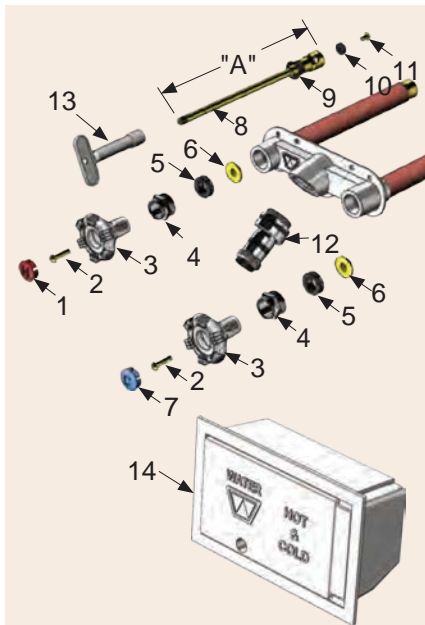

MODEL C22 / B22 PARTS

ITEM	PART#	DESCRIPTION
1	30463	Plug Button-H-Red (for plastic handle)
	30566	Plug Button-H-Red (for metal handle)
2	30002	Handle Screw (2)
3	30542	Wheel Handle - Clear (2)
4	30096	Wheel Handle - Metal (2) <i>Optional</i>
	30539	Packing Nut - Chrome (2)
5	30059	Packing Nut - Brass (2) <i>Optional</i>
	30560	EPDM Packing (2)
6	30006	Packing Support Washer
7	30462	Plug Button-C-Blue (for plastic handle)
	30565	Plug Button-C-Blue (for metal handle)
8	RK-PRV	PRV Valve Stem Assembly (See chart)
9	30459	Check Valve (2)
10	30008	Valve Seat Rubber (2)
11	30804	Retainer Screw (2)
12	50HA-CH	50HA Backflow Preventer - Chrome
	50HA-BR	50HA Backflow Preventer - Brass
13	50012	Tee Key
14	22BX	Box/Door Assembly - Chrome
	RK-22MH	Repair Kit (Metal Handles) Includes
		1 ea: Item 1a, 7a,
		2 ea: Items 2, 3a, 4a, 5, 6, 9, 10, 11

Item 8 - PRV Operating Rod Assy. "A"

	Wall Thickness (Inches)	Overall Length (Inches)	PRV Model C22 & B22
	CC (1 3/4)		N/A
	4	5 7/8	RK-PRV-4
	6	7 7/8	RK-PRV-6
	8	9 7/8	RK-PRV-8
	10	11 7/8	RK-PRV-10
	12	13 7/8	RK-PRV-12
	14	15 7/8	RK-PRV-14
	16	17 7/8	RK-PRV-16
	18	19 7/8	RK-PRV-18
	20	21 7/8	RK-PRV-20
	22	23 7/8	RK-PRV-22
	24	25 7/8	RK-PRV-24

Freezeless Commercial Wall Hydrants Lite Duty Commercial



Hot & Cold Wall Faucet



Model C22

Model B22

- Chrome plate standard
- Model 50HA Double Check Backflow Preventer
- Clear, Round Handles - Standard (Tee Key optional)
- C22 Exposed Head Model 4" - 24" Wall Thickness
- B22 Rectangular Box Model 6" - 24" Wall Thickness
- (6) Inlet Options (See page 2 for details)
- 3/4" male hose thread nozzle
- Stainless steel seat - eliminates wire draw
- EPDM Packing
- Full circle operating threads on valve body and retainer
- No lead solder on all solder joints
- Standard "O" size beveled seat washer
- Adjustable packing nut
- Chrome plated red brass head casting
- 5/16" solid brass valve stem
- Check valve on valve stem
- MAX PRESSURE; 125 p.s.i.
- MAX TEMPERATURE; 120° F

Mild Climate Area Wall Faucets

Choose a close connection Mild Climate wall faucet for areas where freezing conditions are not likely to occur.





- Exposed chrome plate brass head models are available with single check vacuum breaker or double check backflow preventer
- 3 security box models are available for the Model 24 or 26
- Select chrome plated brass, anodized aluminum or modular box and stainless steel door and fascia
- See page 2 for model specifications
- Not intended for potable water applications.

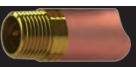

B24/B26

MB24/MB26

Dia. X Min. Length In Heated Area

C		COMBINATION Copper Sweat Fitting 1/2" K, L or M Inside 3/4" M Only Outside
	15/16" Dia X 15/16"	
CP		COMBINATION 1/2" Male Pipe Thread 1/2" Female Sweat
	15/16" Dia X 1 1/4"	
CP3		COMBINATION 3/4" Male Pipe Thread 3/4" Female Sweat
	1 1/16" Dia X 1 3/8"	
P		COMBINATION 1/2" Female Pipe Thread 3/4" Male Pipe Thread
	1 1/16" Dia X 1 3/8"	
PX		1/2" PEX Tube Fitting
	15/16" Dia X 1 1/8"	
PX3		3/4" PEX Tube Fitting
	15/16" Dia X 1 1/8"	

Integral Water Supply Stop MB221-MB224-MB226



- Designed to eliminate the need for entering a building in order to shut off water supply for servicing the hydrant in mild climate areas.
- A convenient integral water supply stop, with screwdriver slot, is located at the faucet head.
- The MB220 series includes the hydrant, composite box and lockable stainless steel door and fascia.
- See page 2 for model specifications

**PRV Pressure Relief Valve

U.S. Patent #6,805,154 B1

Standard on Models C22 & B22

The patented, resetting PRV prevents the faucet tube from bursting in freezing conditions even if a hose is unintentionally left on.

The PRV protects up to 125 psi of backpressure and therefore does not require an add-on vacuum breaker.

Piston activates at approx. 350 psi

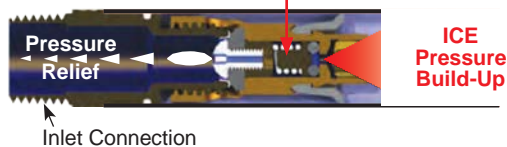

SL-65 Stem Lock

Fits Model 65 & 67 Series Products.



Replace the standard packing nut with the furnished brass locking nut and snap on the lock. 2 keys are included.

A Tee key is included for operating the faucet when lock is removed.



Freezeless Commercial Wall Hydrants Information



NOTICE

- All hydrants are intended For Irrigation and Outdoor Watering.
- All hydrants are not recommended for continuous use.
- All specifications are subject to change without notice.

Visit our website for Patent Information, Individual Spec. Sheets, Installation and Troubleshooting Instructions
www.woodfordmfg.com or call 1-800-621-6032

Limited 5 Year Warranty

All commercial hydrants shown in this brochure are sold with a limited warranty for five years against defects in material and workmanship. We will replace or issue credit (at our option) for defective goods that are returned for inspection and found to be defective within five years of purchase from Woodford.

SHIPPING WEIGHTS

Wall Thickness (inches)*	4	6	8	10	12	14	16	18	20	22	24
Model 65 & 67 (Lbs. Each)**	4.4	4.8	5.2	5.6	6	6.4	6.8	7.2	7.6	8	8.4

*Add 3/8" for all box hydrants

**Add 7.0 Lbs for (B) brass box models

**Add 2.5 Lbs for (MB) modular box models

**Add 2.5 Lbs for all (AL) aluminum box models

Wall Thickness (inches)*	4	6	8	10	12	14	16	18	20	22	24
HC65 & HC67 (Lbs. Each)**	11.5	12.2	12.9	13.7	14.3	15.1	15.8	16.5	17.3	18.1	18.9

*Add 3/8" for all box hydrants

**Add 11.7 Lbs for (B) brass box models

Wall Thickness (inches)*	4	6	8	10	12	14	16	18	20	22	24
C22 (Lbs. Each)**	3.1	3.3	3.5	3.8	3.9	4.2	4.6	4.8	5	5.2	5.4

Add 14.7 Lbs. for B22 brass box models

Cross-Over Models
Also listed on separate
Mild Climate products brochure



24-26 Series

MB24-MB26 Series



MB224-MB226



B24-B26 Series



Woodford Manufacturing Company
2121 Waynoka Road
Colorado Springs, CO 80915 USA
800-621-6032
800-765-4115 (Fax)
sales@woodfordmfg.com
www.woodfordmfg.com

© Woodford Mfg. Co. 2013
Printed in the U.S.A.

MESSIAH COLLEGE – STUDENT ENHANCEMENT PROJECTS
FITNESS CENTER ADDITIONS AND RENOVATIONS

1 SECTION 140010 – CHEMICAL WATER TREATMENT

2
3 PART 1 - GENERAL

4
5 1.1 SECTION INCLUDES

- 6
7 A. Cleaning of closed loop piping systems
8 B. Chemical feeder equipment
9 C. Chemical treatment
10 D. Filter/feeder

11
12 1.2 REFERENCES

- 13
14 A. NFPA 70 - National electrical code.

15
16 1.3 SUBMITTALS

- 17
18 A. Submit in accordance with provisions of section 230010.
19
20 B. Shop drawings: Indicate system schematic, equipment locations, and controls schematics,
21 electrical characteristics and connection requirements.
22
23 C. Product data: Provide chemical treatment materials, chemicals, and equipment including electrical
24 characteristics and connection requirements.
25

26 1.4 REGULATORY REQUIREMENTS

- 27
28 A. Conform to applicable code for addition of non-potable chemicals to building mechanical systems,
29 and for to public sewage systems.
30
31 B. Products requiring electrical connection: Listed and classified by UL as suitable for the purpose
32 specified and indicated.
33

34 1.5 MAINTENANCE SERVICE

- 35
36 A. Furnish service and maintenance of treatment systems for one year from date of substantial
37 completion.
38
39 B. Provide quarterly technical service visits to perform field inspections and make water analysis on
40 site. Detail findings in writing on proper practices, chemical treating requirements, and corrective
41 actions needed. Submit two copies of field service report after each visit.
42

43 1.6 PROCEDURE

- 44
45 A. If this system is to be tied into an existing system than some form of lock-out valve should be utilized
46 until the new system is proper commissioned before being allowed to be tied into the existing
47 system. This will prevent containments for enter the existing system.
48

49 PART 2 - PRODUCTS

50
51 2.1 MANUFACTURER

- 52
53 A. Water Treatment By Design, Mark Coldren, CWT (717) 773-5866- no substitutions
54
55
56

MESSIAH COLLEGE – STUDENT ENHANCEMENT PROJECTS
FITNESS CENTER ADDITIONS AND RENOVATIONS

57
58
59
60
61
62
63
64
65
66
67
68
69
70
71
72
73
74
75
76
77
78
79
80
81
82
83
84
85
86
87
88
89
90
91
92
93
94
95
96
97
98
99
100
101
102
103
104
105
106
107
108
109

110

2.2 EQUIPMENT

- A. One five gallon filter/feeder with legs for the hot water closed loop and one for the chilled water closed loop, model Vector FA-1000AL VF-1000HT250
- B. One case of twenty-four filter cartridges shall be provided: 6 ten micron, 6 five micron, and 12 one micron filters for each system therefore a total of 48filters.

2.3 SYSTEM PREPARATION

- A. Water flush applies to the following systems:
 - 1. Closed Loop Water: Dump and refilled the closed loop system to remove existing raw contaminants and suspended solids. This procedure should be done twice.
- C. Refill the system with water and allow for 10 percent by volume of pre-cleaner Formula 6960 for the removal of scale, glycol oils and other extraneous materials. Add the required amount of cleaner and circulate for 6 to 8 hours at 150°F, or 12 to 24 hours if less than 150°F. Be sure that all zones are open during this cleaning process.
- E. Drain the system after the required circulation period as quickly as possible, this will prevent settling of foulants. Run circulating pumps and flush with clean water until the discharge water is clear and the pH is within 0.5 of the incoming makeup water, and the conductivity of the loop water is within 50 micro ohms of the make-up water conductivity. Once the system water is clear, remove, clean and replace all strainers.
- F. Immediately add Formula 6204 to obtain a residual of 1000-1200 ppm. Allow time for the inhibitor to circulate and retest to ensure that this level of inhibitor has been achieved within the system.
- H. Service on a quarterly basis making necessary adjustments to maintain the residual with the recommended operational control ranges of 600 to 1200 ppm. as Nitrite.

PART 3 - EXECUTION

3.1 INSTALLATION

- A. Install in accordance with manufacturer's instructions.
- B. Provide one filter/feeder on each system. Filter feeder shall be plumbed across the common headers for the discharge and return lines.

3.2 WATER TREATMENT PROGRAM

- A. The Water Treatment Company shall provide:
 - 1. Installation and system start-up procedure recommendations
 - 2. Pre-operation system cleanout procedure supervision
 - 3. Training of operating personnel on proper feeding and control techniques
 - 4. Quarterly field service and consultation meetings
 - 5. Any necessary log sheets and record forms
 - 6. Any required laboratory and technical assistance
- B. All services shall be provided by a qualified, full-time representative of the Water Treatment Company.

END OF SECTION

**SECTION 160010
GENERAL PROVISIONS – HVAC**

PART 1 - GENERAL

1.1 WORK INCLUDED

- A. HVAC Work shall consist of the labor, materials and equipment required for installing the heating, ventilating and air conditioning systems.
- B. Mechanical Work shall include the following Specification Sections as outlined:

Section 200010	General Provisions – HVAC
Section 230505	HVAC Basic Materials
Section 230510	HVAC Pipe and Pipe Fittings
Section 230515	HVAC Piping Specialties
Section 230525	HVAC Valves
Section 230530	HVAC Supports and Anchors
Section 230535	HVAC Sound and Vibration Control
Section 230710	HVAC Insulation
Section 231020	Variable Frequency Drives
Section 232110	HVAC Pumps
Section 233010	Air Distribution
Section 233020	Variable Air Volume Systems
Section 233410	Fans and Gravity Ventilators
Section 233510	Dust Collection System
Section 233810	Kitchen/Fume Hoods
Section 234110	Air Filtration
Section 235710	Heat Transfer
Section 237310	Central Station Air Handling Units
Section 238110	Unitary Equipment
Section 238210	Terminal Heating Units
Section 239010	Building Automation System
Section 239510	Testing, Adjusting and Balancing of HVAC System
Section 239610	Wiring of HVAC Equipment

- C. HVAC Work shall be bid as subcontracts in accordance with the bidding requirements.

1.2 REFERENCE STANDARDS

- A. Portions or all of certain recognized industry or association standards referred to herein as being a requirement of these Specifications shall be considered as binding as though reproduced in full herein. Unless otherwise stated the referenced standard shall be the standard which is current as of the date of issuance of these Specifications. Reference may be made to standards either by full name or for the sake of brevity by letter designation only. The following is a list of the most commonly used standards, but is not all inclusive for these Specifications:

ABMA	American Bearing Manufacturers Association
ADA	Americans with Disabilities Act
AGA	American Gas Association
AMCA	Air Moving and Conditioning Association
ANSI	American National Standards Institute
API	American Petroleum Institute
ARI	American Refrigeration Institute
ASHRAE	American Society of Heating, Refrigerating and Air- Conditioning Engineers
ASME	American Society of Mechanical Engineers
ASSE	American Society of Sanitary Engineers
ASTM	American Society for Testing and Materials
AWS	American Welding Society
AWWA	American Water Works
Association	CISPI Cast Iron Soil Pipe Institute
FM	Factory Mutual Engineering Corporation
I-B-R	Institute of Boiler & Radiator Manufacturers
NEC	National Electrical Code
NEMA	National Electrical Manufacturers Association
NFPA	National Fire Protection Association
OSHA	Occupational Safety and Health Administration
PDI	Plumbing Drainage Institute
SMACNA	Sheet Metal and Air Conditioning Contractors National Association, Inc.
UL	Underwriters Laboratories, Inc.

1.3 PERMITS AND INSPECTIONS

- A. Secure all permits and inspections required by applicable authorities and pay all costs in connection with the Work.
- B. Schedule all inspections required by applicable authorities. Certificates shall be in triplicate and shall be delivered to Owner.
- C. Piping work, specialties, or equipment shall not be concealed or covered until same have been tested and inspected by municipal inspector(s) and observed by Owner. Municipal inspector(s) record of inspections shall be delivered to Owner. Owner and municipal inspector's witnessing of tests shall not relieve Contractor of his responsibility for concealed piping work and specialties.

1.4 CODES AND STANDARDS

- A. Mechanical Work is subject to provisions of the Pennsylvania Uniform Construction Code and has been designed to be in compliance with the Code. Design aspect of the Project shall not be altered regarding building envelope or selection of HVAC, service water heating systems and equipment. Supplemental data published by equipment and system manufacturers to substantiate energy conservation efficiencies throughout the Project shall be furnished at request of Owner.
- B. Mechanical Work shall meet requirements of the National Fire Protection Association, all federal, state, and municipal authority's laws, rules and regulations applicable to the Work and public utilities having jurisdiction over systems specified herein.
- C. Domestic water heater(s) shall be constructed and tested in accordance with recommendations of the National Fire Protection Association, and ASME Code. Equipment shall be stamped with the ASME symbol and National Board number and shall be inspected during construction by an inspector who has been commissioned by the Pennsylvania Department of Labor and Industry to perform such service. Equipment shall be prepared for initial inspection in accordance with Pennsylvania Department of Labor and Industry regulations.
- D. Plumbing Work shall be installed in conformity with applicable portions of the International Plumbing Code, state plumbing codes, local ordinances, and shall be approved as Project progresses by Owner, and local plumbing inspector. Contractor shall certify domestic water systems for compliance with Pennsylvania Plumbing System Lead Ban & Notification Act (No. 33-1989). Nothing in the Specifications shall be construed to permit deviation from requirements of governing code(s).
- E. Installation of all gas piping and gas burning equipment shall conform to recommendations of the American Gas Association, Owner's insurance carrier, and the local utility.
- F. The handling and use of CFC and HCFC refrigerants, whether leaking, venting, recovering, etc., shall be in accordance with US Environmental Protection Agency regulations CFR 58 FR 28660, ASHRAE 15- Safety Code for Mechanical Refrigeration, and ANSI/ASHRAE 34 - Number Designation and Safety Classification of Refrigerants.
- G. Electrical Work shall meet requirements of the National Electrical Code and all federal, state, and municipal authority's laws, rules and regulations applicable to the Work.
- H. Where applicable, materials and equipment shall bear the label of approval of Underwriters Laboratories, Inc.
- I. Reference to codes and standards listed herein shall constitute minimum acceptable requirements. Where Drawings and Specification requirements exceed those of codes listed, Drawings and Specifications shall take precedence for Work of this Project.
- J. If Contractor, during the course of work, observes the existence of hazardous materials in the structure or on the project site, Contractor shall promptly notify Owner. Contractor shall not perform any work pertinent to the hazardous material prior to receipt of special instructions from Owner. "Hazardous materials", for the purpose of this Specification, are defined as asbestos, PCB's, petroleum, radioactive material, or hazardous waste substances.

1.5 SUBSTITUTIONS

- A. Specifications for each piece of equipment and each item of material are written around a product of a specific base manufacturer. This base manufacturer is the basis of design, dimensions and details. The base manufacturer's name and model information are included with the product description as the first named manufacturer under the heading "Acceptable Manufacturer".
- B. "Substitution" manufacturers are defined as any manufacturer other than the one used as the basis of design. "Substitution" manufacturers will be permitted, in accordance with the bidding requirements and where indicated herein.
- C. Manufacturers named in the product description, in addition to the base manufacturer, are "substitution" manufacturers, have been determined to be manufacturers capable of manufacturing products similar to the base manufacturer and these manufacturers are acceptable "substitution" manufacturers to the base manufacturer. Where additional manufacturer's names do not appear with the base manufacturer, the Owner reserves the right to disallow any "substitution" manufacturers. Where the base manufacturer's name is followed by the term "no substitution", no "substitution" manufacturers will be considered.
- D. Naming of specific manufacturers shall not be construed as eliminating products or services of other "substitution" manufacturers having comparable items. Where permitted by these Specifications, and where Bidder desires to use other "substitution" manufacturers, he may submit a request for approval to use the "substitution" manufacturer in accordance with bidding requirements.
- E. Products described in Specifications are intended to set a quality level and ensure a workable system. "Substitution" of manufacturers, including those herein named, may be made only after approval of Owner. Bidder shall assume full responsibility for installation and dimensional changes required by the use of all "substitution" manufacturer's products, including revisions to wiring, controls, piping, structural revisions, etc., and all room or space changes as required due to dimension differences of the "substitution" manufacturer product.
- F. Where the Bidding requirements call for submittal for approval of substitutions prior to bids due, all approvals given are for "substitution" manufacturers only, not approval of any particular product. An approved "substitution" manufacturer's product must comply with all requirements of the specifications and drawings for the base manufacturer's product.

1.6 SHOP DRAWINGS AND PRODUCT DATA

- A. Submit shop drawings and product data for approval to Owner. Shop drawings and product data shall have been reviewed and approved (stamped) by Contractor furnishing the equipment. If evidence of this Contractor's approval does not appear on submittal data, submittals will be returned without review. Following Owner review, submittals not approved or requiring resubmission shall be corrected and resubmitted until satisfactory. Work indicated on shop drawings and product data shall not be executed until submittals have been approved.
- B. Submittals for equipment and material shall indicate room numbers, drawing identification symbols, product type, capacities, accessories, connection sizes, electrical characteristics, wiring diagrams, and installation instructions. Each shop drawing shall have specified items, accessories and options, as applicable to this Project, clearly marked. Catalog numbers, part numbers, etc. on shop drawings will not be reviewed for correctness, Contractor is responsible

for verifying correctness of these and that they relate to the options, accessories, features, etc. marked on the shop drawings. Shop drawings not clearly marked as to only that which will be provided for this Project will not be approved.

- C. In as much as it is not the purpose of the submittal process to assure that the Contractor is meeting all the requirements submittal review by Owner is for conformance with design concept of the Project and general compliance with information given in the construction documents. Approval, corrections and/or comments made as part of the submittal review do not relieve the Contractor of the responsibility from conformance to applicable codes and laws. Contractor is responsible for dimensions, quantities, and performance requirements to be confirmed and correlated at the job site; for information that pertains solely to the fabrication processes or to techniques of construction; and for all coordination with the Work of all trades. Refer to paragraph entitled "Substitutions" in this section of the specifications.

- D. At the time of each submittal, Contractor shall give Owner specific written notice of such variations, if any, that the Shop Drawing or product submitted may have from the requirements of the Contract Documents, such notice to be in a written communication separate from the submittal; and, in addition, shall cause a specific notation to be made on each Shop Drawing and sample submitted to Owner for review and approval of each such variation. Owner's review and approval of Shop Drawings or products shall not relieve Contractor from responsibility for any variation unless Contractor has in writing called the Owner's attention to each such variation at the time of each submittal and Owner has given written notation thereof incorporated in or accompanying the Shop Drawing or product approval; nor will any approval by Owner relieve contractor from responsibility for complying with the requirements of this paragraph.

- E. Shop drawing submittals shall be accompanied by a transmittal sheet with the applicable specification section number and the "name" of the item or items being submitted clearly indicated on the transmittal. All "names" on the transmittal shall match exactly the "names" listed in the specifications for the item being submitted.

- F. The name of the supplier, distributor, subcontractor, etc., who will furnish equipment and items to the Contractor shall appear on the shop drawings when submitted. Shop drawing submittals without supplier's, distributors, subcontractors, etc., name will not be reviewed and will be returned without review.

- G. One complete set of approved shop drawings and product data shall be delivered to Owner at completion of Work. Include lists of manufacturer's parts and part numbers.

1.7 COORDINATION – GENERAL

- A. Work shall be governed by requirements set forth in the conditions of the Contract.

- B. Provide all labor, materials, and equipment required for completion of the Work of Section 16.

- C. Bidders shall visit the project site to determine actual conditions which will be encountered in completing the work of this project.

- D. Drawings are generally indicative of Work to be installed but may not indicate all bends, fittings, elbows, etc., required to meet conditions. Where items shown herein described, are not clearly understood, Bidders shall confer with Owner.

- E. Coordinate Work of Section 16 with that of other trades so that Work will be installed in the most direct manner and so that interference between piping, ducts, conduits, equipment, and architectural or structural features will be avoided. Work installed in an arbitrary manner without regard for Work of other trades or equipment servicing requirements will be rejected in any situation where an undesirable condition or an unfair hardship for other trades, or Owner, results.
- F. Provide sufficient scaffolding and hoist or rig material and equipment into place, or arrange for rigging by others. In any case, rigging or hoisting for Work of Section 16 shall be at the expense of Contractor.
- G. Unless otherwise indicated, provide structural steel members as required for support of equipment and materials furnished under Section 16. Provide all hangers and supports, as specified, detailed, or in accordance with accepted industry standards.
- H. Equipment shall be installed in accordance with equipment manufacturer's installation instructions. Obtain manufacturer's installation instructions prior to roughing-in.
- I. Where equipment is furnished by other trades for installation as Work under Section 16, or where electrical service or utility connection to equipment installed by others is indicated as Work of Section 16, obtain approved shop drawings and installation instructions from the respective contractor prior to roughing-in. Discrepancies between installation instructions shall be brought to the attention of Owner.
- J. Where equipment is indicated to be furnished as Work of Section 16 for installation by others, or where equipment furnished and installed under Section 16 requires utility connections by others, provide to the respective contractor one copy of an approved shop drawing and installation instructions necessary for execution of his work.
- K. Unless specifically indicated, communication between the mechanical and electrical systems equipment and panels shall be via a dedicated wiring system furnished and installed by the systems installers. These systems shall be separate from all other data communication networks within the building. Contractor may request approval for providing communications on the Owner's building data network. If Owner's written approval is obtained, the system installer shall fully coordinate the necessary data network connections with the Owner, the Owner's technology consultant, and the contractor responsible for installing the building data network system. The systems shall follow the Owner's data network labeling scheme for outlets and jacks, operation protocols, and shall adhere to all network security measures. The system installer shall be responsible for all costs associated with equipment, materials, and labor necessary to furnish and install the communications network including, but not limited to: jacks, wall plates, cables, conduits and boxes, patch panels, patch cords, additional Owner switches and equipment, additional systems equipment, and programming services.

1.8 COORDINATION – NEW CONSTRUCTION

- A. Openings and recesses, including cutting, patching and finishing, necessary for installation of mechanical equipment in new construction will be provided by General Contractor. Coordinate locations, dimensional data, and scheduling of Work with General Contractor.
- B. Where piping is run concealed in concrete masonry unit (block) walls, Contractor shall be responsible for installing his work in cores of block for mason to wall-in as he carries up wall. Coordinate locations and scheduling of Work with General Contractor.

- C. Provide concrete foundation pads for mechanical equipment installed under this Section. Foundations for compressors shall extend through floor slab and be isolated from floor by 1/2-inch-thick expansion joint material. Foundations for base mounted pumps and water heaters shall be installed on floor slab. Unless otherwise noted, foundations shall be 4 inches above finished floor and extend a minimum of 2 inches beyond base or bedplate. Inserts and anchor bolts shall be poured into foundation according to equipment manufacturer's instructions. Method of setting, aligning, and anchoring shall be as recommended by equipment manufacturer
- D. General Contractor will furnish and install structural steel members for supporting rooftop equipment. Provide General Contractor with dimensional data required for fabrication of supports.
- E. General Contractor will furnish and install all base flashing for roof mounted equipment. Furnish and install all cap flashing integral to roof mounted equipment and field fabricated. Coordinate with General Contractor's roofer.
- F. Electrical Contractor will wire all motors, resistance coils and controllers, except as noted otherwise in Section 180200, Wiring of Mechanical Equipment. Where motor starters and disconnect switches are supplied, and shipped loose with mechanical equipment, they shall be mounted and wired by Electrical Contractor. Verify available power characteristics prior to ordering equipment.

1.9 COORDINATION – EXISTING CONSTRUCTION

- A. Cut all openings required in existing construction for installation of equipment and material. Perform all cutting, patching, and refinishing as required to match surroundings.
- B. Existing Ceilings: Remove existing ceiling tile where required for installation of mechanical Work. Replace ceiling tiles as Work is completed. All damaged or broken ceiling tile caused by Contractor's workers shall be replaced by Contractor at no cost to Owner.
- C. Utility interruptions (including campus heating and chilled water) and tie-ins shall be coordinated with Owner a minimum of 14 days in advance of Work.

1.10 EXCAVATION AND BACKFILL

- A. General Contractor will perform excavation and backfill required for Work of this Division, inside and outside building. Coordinate extent of excavation required with General Contractor.

1.11 PAINTING

- A. Equipment furnished under Section 16 that is pre-painted or pre-finished by manufacturer shall have all nicks, scratches, blemishes, and rust spots cleaned, primed, and refinished prior to final acceptance by Owner.
- B. General Contractor will paint exposed unfinished equipment, piping, ductwork, etc., installed under Section 16.

1.12 EXISTING EQUIPMENT

- A. Removal of Existing Equipment and Materials: Items of value as determined by Owner shall be stored on site where directed by Owner. Equipment and material that Owner does not wish to retain shall be legally disposed of offsite. Do not remove any equipment and materials from the site without Owner's approval.
- B. Relocation of Existing Equipment and Materials: Mechanical equipment indicated as "to be relocated", shall be removed, relocated, reinstalled, and reconnected. Before reinstallation, equipment shall be cleaned and nicks and scratches shall be touched-up. Broken parts shall be brought to the attention of Owner prior to removal or any disassembly.

1.13 RECORD DOCUMENTS

- A. Maintain a set of Contract Documents, i.e., Specifications, Drawings, Addenda, Modifications and approved submittals at the site, in good order and annotated to show all changes made during construction process. These record documents shall be delivered to Owner either prior to or with submission of Application for Final Payment.
- B. Refer to Division 01 for additional requirements.

1.14 OPERATION AND MAINTENANCE MANUALS

- A. One (1) complete hard copy and 1 soft copy/electronic set(s) on compact disc(s) of the operating and maintenance manual labeled as described herein shall be submitted to the Owner for approval in as many 3-ring loose leaf binders as required. The copies shall be submitted a minimum of two weeks prior to any instructions and demonstrations to Owner's personnel.
- B. The manuals shall be typewritten and the information shall be arranged in a logical order for use by the Owner in maintaining the equipment and systems installed on the project.
- C. The manuals shall include, but not be limited to the following:
 - 1. Table of contents.
 - 2. Materials list with place of purchase.
 - 3. List of normally replaced items, such as filters, fuses, belts, seals, screens, etc., indicating style, rating, size, etc., and place of purchase.
 - 4. Approved copies of submittals, including component wiring diagrams and BAS wiring piping diagrams of all installed systems indicating all connections, color coding, functions, locations, etc. Approved "As-Noted" submittals shall be corrected to incorporate all approval notes prior to inclusion in the manuals.
 - 5. Installation, servicing, maintenance and operating instructions for all systems and components with place of original purchase, and name, address and phone number of person servicing system.

6. Manufacturer's guarantees and warranties.
7. System and equipment start-up, seasonal changeover, and seasonal shut-down with pre-start checklists and precautions.
8. System and equipment troubleshooting guides.
9. Reference documents which shall include construction drawings list, record set of drawings list, test and balance records.
10. Testing and balancing procedures for each system(s) and system(s) components.
11. Copies of all inspection certificates and approvals from all inspection agencies.
12. Copies of approved testing, adjusting and balancing reports.
13. Copy of all Mechanical Vibration Analysis and Alignment Verification Reports.

D. Refer to Division 01 for additional requirements.

1.15 SPARE PARTS AND EQUIPMENT

- A. Furnish to Owner spare parts and equipment at project closeout in accordance with each respective specification section that requires spare parts and equipment.

1.16 FINAL PAYMENT AND ACCEPTANCE

- A. Upon written notice that Work is complete and installed in accordance with intent of Specifications, Mechanical Engineer will make a final inspection with Owner and Contractor. If Mechanical Engineer determines that Work is incomplete, or it contains deficiencies, Contractor shall immediately take such measures as are necessary to complete Work or remedy such deficiencies.
- B. Obligations of Contractor, when making application for final payment, are contained in various sections of the Specifications, Addenda or modifications. These obligations consist of furnishing instruction, record drawings, printed material, tools and devices, clean-up services, credit, certificates, valve listings, start-up test reports.
- C. If documentation required does not accompany final payment application, Mechanical Engineer will not accept Work and will advise that final payment is not recommended. Mechanical Engineer will indicate in writing reasons for refusing to recommend final payment.
- D. If, on basis of Mechanical Engineer's observation of Work during construction and final inspection and Mechanical Engineer's review of final application for payment and accompanying documentation, and if Mechanical Engineer is satisfied that Work has been completed and Contractor has fulfilled all obligations, Mechanical Engineer will indicate in writing his recommendation for final payment. If, through

no fault of Contractor, final completion of Work is significantly delayed and if Mechanical Engineer so confirms, Mechanical Engineer will recommend payment to Contractor for that portion of the Work fully completed and accepted.

PART 2 - PRODUCTS

2.1 MATERIALS

- A. All materials and equipment shall be new, without imperfections or blemishes, and shall be protected from the elements prior to installation.
- B. Contractor shall be responsible to verify all furnished materials and equipment are suitable for the service, temperatures, and pressures where they are installed.

PART 3 - EXECUTION

3.1 INSTALLATION

- A. Work shall be installed by mechanics skilled in the trade involved.
- B. All mechanical equipment and materials shall be installed to allow access to and to facilitate service, maintenance, repair, replacement, etc., of components to all equipment furnished and installed under this Division of the specifications, furnished and installed under all other Divisions of the specifications, and, where applicable, Owner furnished and installed and Owner's existing equipment.
- C. Duct work, piping, equipment, etc., shall be installed in such a manner as to preserve access to equipment installed under this project and, where applicable, existing equipment.

3.2 CLEANING

- A. Upon completion of Work, remove all dirt, foreign materials, stains, fingerprints, etc., from all parts and equipment.
- B. Remove all construction debris and vacuum interior spaces of all compartmental equipment.
- C. Conduct cleaning and disposal operations to comply with codes, ordinances, regulations and anti-pollution laws.
- D. Work shall be subject to inspection by the Owner.

3.3 PROTECTION FROM DUST AND DEBRIS

- A. During patching, painting, ceiling removal and replacement, working on the ceiling or on things above the ceiling, etc., maintain cloths or suitable building paper covers to protect building surfaces. Protective measures (drop cloths, protective covers, etc.) shall be placed and sealed over all furniture and equipment to keep items clean and protected against dirt, dust and debris from entering furniture and equipment that the Owner has not removed.
- B. Upon completion of work each day when building is occupied, remove all temporary covers, drop cloths and debris and vacuum clean all worked-in areas to eliminate carrying of dirt materials and dirt tracking throughout building during times construction is not proceeding.

3.4 CONSTRUCTION SEQUENCE

- A. Work to be installed through existing building shall be installed at other than normal occupied hours. Coordinate installation times with Owner. Contractor shall be responsible for removing and replacing ceilings for installing items above ceilings in these existing areas. All ceilings removed shall be replaced prior to normal occupied hours.

3.5 OPERATING INSTRUCTIONS

- A. Engage qualified instructors to instruct Owner's personnel to adjust, operate, and maintain systems, subsystems, and equipment not part of a system.
- B. Provide instruction at mutually agreed on times. Schedule training with Owner with at least seven days' advance notice.
- C. Instructor shall operate system(s) in order to demonstrate fulfillment of contract requirements and educate Owner's personnel on the following:
 - 1. Basis of system design and operational requirements.
 - 2. Documentation provided in the operating and maintenance manuals.
 - 3. Startup and normal operation instructions.
 - 4. Warning, trouble indications, emergency operation and failure instructions.
 - 5. Adjustments.
 - 6. Inspection and preventative maintenance.
 - 7. Diagnostics and repairs.

3.6 WARRANTIES

- A. Where extended warranties beyond the normal one-year warranty are, as specified herein, to be applied to a particular item of equipment or system, furnish to Owner a description of the

warranty along with any required registration and signature of manufacturer's authorized personnel.

- B. Contractor shall be responsible for coordinating with and having the manufacturer administer these warranties for the full extent of time the warranty will be in effect.
- C. Contractor shall be responsible for administering and servicing all extended warranties for the life of each extended warranty at no additional cost to Owner. Owner's responsibility will be for additional costs for parts associated with warranties that are warranted on a pro-rated basis. All labor for administering and servicing the extended warranty, including actual replacement of parts, will be the responsibility of the Contractor for the extended warranty period. All unwarranted shipping and handling costs for parts and equipment will be the responsibility of the Owner.

****END OF SECTION****

SECTION 160020
HVAC BASIC MATERIALS

PART 1 - GENERAL

1.1 WORK INCLUDED

- A. The Work of this Section shall consist of the labor, materials and equipment required for the installation of basic materials and motors associated with HVAC systems.

1.2 SUBMITTALS

- A. Submit for approval in accordance with specified submittal procedures:
1. Access Panels
 2. Fire Stop Sealing System
 3. Pipe Penetration Seal
 4. Pipe Portals
 5. Equipment Nameplates; including itemized listing of nameplate equipment designations
 6. Engineered Strut Support System; including structural calculations
 7. Motors; submit with each piece of equipment

PART 2 - PRODUCTS

2.1 ACCESS PANELS

- A. Access Panel Specification No. 1
1. Acceptable Manufacturer: Milcor Style AP for acoustical plaster, Style AT for acoustical tile, or Karp, Krieger, Bilco.
 2. Type: Acoustical ceiling.
 3. Construction: 16 gage galvanized steel frame, 18 gage galvanized steel panel. Recessed to accommodate acoustical ceiling tile. Continuous hinge, steel with stainless steel pin.
 4. Closing Feature: Flush, screw driver operated lock with steel cam.
- B. Access Panel Specification No. 2
1. Acceptable Manufacturer: Milcor Style DW, or Karp, Krieger, Bilco.
 2. Type: Gypsum wallboard.
 3. Construction: 16 gage steel frame, 14 gage steel panel.
 4. Concealed spring hinges. Prime coat finish for field painting.
 5. Closing Feature: Flush, screwdriver operated lock with steel cam.

- C. Access Panel Specification No. 3
1. Acceptable Manufacturer: Milcor, or Karp.
 2. Type: Fire rated.
 3. Construction: 16 gage steel frame, 20 gage steel panel.
 4. Continuous hinge with stainless steel pin. Automatic panel closer. Factory attached masonry anchors.
 5. Rating: UL listed 1-1/2 hour (B label), temperature rise 30 minutes, 250 degrees F. maximum.
 6. Closing Feature: Self-latching lock, direct action knurled knob, interior latch release mechanism.

- D. Access Panel Specification No. 4
1. Acceptable Manufacturer: Milcor Style M, or Karp, Krieger, Bilco.
 2. Type: Masonry, tile, or wood.
 3. Construction: 16 gage frame, 14 gage panel. Concealed spring hinges. Prime coat finish for field painting or stainless steel, satin finish, as required.
 4. Closing Feature: Flush screwdriver operated lock with steel cam.

- E. Access Panel Specification No. 5
1. Acceptable Manufacturer: Milcor Style K, or Karp, Krieger, Bilco.
 2. Type: Plastered surfaces.
 3. Construction: 16 gage frame, 14 gage panel. Concealed spring hinges. Prime coat finish for field painting.
 4. Closing Feature: Flush, screwdriver operated lock with steel cam.

2.2 FIRE STOP SEALING SYSTEM

- A. Acceptable Manufacturer: Nelson Firestop Products CLK Silicone Sealant, or 3M Fire Protection Products, RectorSeal, Specified Technologies (STI), Tremco.
- B. Materials: Single component, ready-to-use, water-resistant, flexible elastomeric silicone sealant. Non-sag/gunnable grade for penetrations in vertical surfaces, self-leveling grade for floor applications.
- C. Compliance: Fire endurance tested per ASTM E-814 (UL 1479). In addition to compliance as a fire stop, the cured sealing system shall not permit smoke or water penetration.

2.3 PIPE PENETRATION SEAL

- A. Acceptable Manufacturer: Thunderline Link Seal.
- B. Seals shall be modular mechanical type, consisting of interlocking synthetic rubber links shaped to continuously fill the annular space between the pipe and wall opening. Each link shall have a

bolt/pressure plate tightening assembly. Final installation shall be watertight and provide an electrical insulation between pipe and wall sleeve/opening.

2.4 PIPE PORTALS

- A. Acceptable Manufacturer: Pate Style PCA, or Roof Products & Systems Corp.
- B. Construction: 18 gage galvanized steel, unitized construction with integral base plate.
- C. Standard Features
 - 1. Built-in raised cant.
 - 2. Wood nailer.
 - 3. 3 lb. density insulation.
 - 4. Acrylic clad ABS plastic cover, fastening screws, graduated step boots with stainless steel clamps.

2.5 EQUIPMENT NAMEPLATES

- A. Laminated phenolic, two outer layers of white phenolic and an inner layer of black with engraving depth to the inner layer.
- B. Nameplate and lettering suitably sized for their location, but not less than 1/4 inch high letters.

2.6 EQUIPMENT LOCATION LABELS

- A. Equipment location labels shall be self-adhering, 3/4 inch diameter, gloss vinyl circles. Labels shall be placed on the T-bar of the adjoining ceiling tile to be removed for access to item. Color-coding of labels shall be as directed by Owner.

2.7 ENGINEERED STRUT SUPPORT SYSTEM

- A. Acceptable Manufacturer: Unistrut Corporation, or as approved.
- B. General: Provide all engineering, material, fittings, anchors, and related accessories for installation of the engineered strut support system. Submit structural calculations with design criteria, selection of framing members, fittings, accessories, and shop/assembly drawings.
- C. Channel members shall be structural grade steel conforming to ASTM A-1011 SS GR or A-653 GR 33. Fittings shall be fabricated from steel conforming to ASTM A 575, A 576, A 36, or A 635. Components shall be pre-galvanized by hot dip process prior to roll forming with G90 zinc coating conforming to ASTM 123 or A 153.

2.8 MOTORS

- A. Motor Characteristics:

1. Duty: Continuous duty at ambient temperature of 40 degrees C and at an altitude of 3300 feet above sea level.
2. Capacity and Torque Characteristics: Sufficient to start, accelerate, and operate connected loads at designated speeds, at installed altitude and environment, with indicated operating sequence, and without exceeding nameplate ratings or considering service factor.

B. Three Phase Motors:

1. Description: NEMA MG 1, Design B, medium induction motor.
2. Efficiency: Premium efficiency, as defined by NEMA MG 1.
3. Service Factor: 1.15.
4. Insulation: NEMA Class F.
5. Sound Power Levels: Conform to NEMA MG 1.
6. Bearings: Grease lubricated anti-friction ball bearings with housings equipped with plugged provision for re-lubrication, rated for minimum AFBMA 9, L-10 life of 200,000 hours.
7. Thermal Protection: Internal, automatically reset.
8. Motors Used with Variable Frequency Drives:
 - a. Windings: Copper magnet wire with moisture-resistant varnish, designed and tested to resist transient spikes, high frequencies, and short time rise pulses produced by pulse-width modulated inverters.
 - b. Premium-Efficient Motors: Class B temperature rise; Class F insulation.
 - c. Inverter-Duty Motors: Class F temperature rise; Class H insulation.
 - d. Shaft grounding ring.

C. Single Phase Motors:

1. Larger Than 1/20 HP: One of the following, to suit starting torque and requirements of specific motor applications:
 - a. Permanent-split capacitor.
 - b. Split phase.
 - c. Capacitor start, inductor run.
 - d. Capacitor start, capacitor run.
2. 1/20 HP and Smaller: Shaded-pole type. Multispeed Motors: Variable-torque, permanent-split-capacitor type.
3. Bearings: Pre-lubricated, antifriction ball bearings or sleeve bearings.
4. Thermal Protection: Internal, automatically reset.

D. ECM, where required in equipment specifications:

- a. Variable-speed, DC, brushless motors specifically designed for use with single phase, 120 or 277 volt, 60 hertz electrical input.
- b. Operated by a single phase integrated controller/inverter that operates the wound stator and senses rotor position to electronically commutate the stator.

- c. Designed for synchronous rotation.
- d. Permanent magnet type motor rotor with near zero rotor losses.
- e. Able to be mounted with shaft in horizontal or vertical orientation.
- f. Permanently lubricated with ball bearings.
- g. Direct coupled to the blower.
- h. Integral thermal overload protection.
- i. Minimum of 70% efficiency over its entire operating range.
- j. Anti-back rotation system or provide a motor that is designed to overcome reverse rotation and not affect life expectancy.
- k. Inductors to minimize harmonic distortion and line noise.
- l. Motor control module:
 - 1) Built-in soft start and soft speed change ramps.
 - 2) Electronics and built-in surge protectors to protect the solid state controls from line transients.
 - 3) Variable speed mode to receive a variable control voltage signal from a DDC system in response to external PID outputs.
- m. Motor bearings designed to reduce (EDM) pits electrical discharge machining pits or circumferential ring of conductive microfibers to discharge harmful currents.

PART 3 - EXECUTION

3.1 INSTALLATION

A. Access Panels

- 1. Furnish and install access panels in ceilings and walls for service and repair access to concealed equipment, including, but not limited to:
 - a. Valves: hand operated and automatic.
 - b. Strainers and traps.
 - c. Backflow preventers.
 - d. Air vents.
 - e. Gages and thermometers.
 - f. Pressure regulating/reducing valves.
 - g. Expansion compensators.
 - h. Flow measuring devices.
 - i. Dampers: volume, control, fire/smoke.
 - j. All control operators/devices.
- 2. Minimum Size: 18 inches by 18 inches. Where restrictions will not permit minimum size, verify access panel size with Owner.
- 3. Provide access panels in accordance with the following schedule:

ACCESS PANEL SCHEDULE	
Application	Access Panel Spec. No.
Acoustical tile or acoustical plaster finishes	1
Gypsum board (dry wall) finishes	2
Fire rated walls	3
Masonry, tile, or wood finishes	4

ACCESS PANEL SCHEDULE

Application	Access Panel Spec. No.
Plastered finishes	5

B. Sleeves and Plates

1. Furnish and install sleeves for all pipes passing through floors, walls, partitions, slabs, grade beams and foundations.
2. Layout, size, and locate sleeves such that they be set and installed prior to pouring concrete, or when masonry is being constructed.
3. Core drilled openings above grade in solid concrete need not be sleeved but must be clean and neat without cracking or spalling.
4. Sleeves shall be standard weight galvanized steel pipe having square cut ends with anchoring lugs welded on. Horizontal sleeves through walls, grade beams, foundations, and partitions shall be flush with finished wall faces. Vertical sleeves through floors shall extend 2 inches above finished floor and be flush with finished ceiling or underside of floor construction. Sleeves in pits or below grade shall be painted or coated with one coat of coal tar pitch paint.
5. Size sleeves such that internal diameter is 2 pipe sizes or a minimum of 2 inches larger than outside diameter of bare pipe for uninsulated lines and 2 inches larger than outside diameter of insulation and jacket for insulated lines. Center pipes in sleeves.
6. For pipes passing through floors, slabs, walls, grade beams, or foundations at or below grade and in pits, the annular space between outside of pipe or insulation and inside of sleeve shall be packed with a pliable, non-hardening waterproof mastic sealer or a cement-base quick-set repair mortar.
7. For lines passing through walls and floors above grade and with no fire or smoke rating, the annular space between outside of pipe or insulation and inside of sleeve or concrete shall be packed tight with batt-type fiberglass insulation.
8. For pipes passing through walls and floors above grade with smoke or fire rating of one hour or more, the annular space between outside of pipe or insulation and inside of sleeve or concrete shall be sealed with fire stop sealing system.

C. Fire Stop Sealing System

1. All floor and interior wall penetrations with smoke or fire rating of one hour or more shall be sealed.
2. Prepare penetration and install sealing material in accordance with the manufacturer's recommendations.
3. Through penetration fire stop sealing systems shall be identified on both sides with permanently mounted, preprinted vinyl labels which include the following information:

- a. The words “Warning: Through Penetration Firestop System – Do Not Disturb” or similar phrase.
- b. Manufacturer’s brand name, product type or catalog number
- c. Testing agency designation and rating
- d. Installer’s Name
- e. Installation Date
- f. Piping labeled with directional arrows on any pressurized water system

D. Equipment Nameplates

1. Furnish and install a full complement of nameplates for all items of HVAC equipment installed as Work of this Division, including boilers, chillers, pumps, air handling units, fans and building automation system panels.
2. Install nameplates parallel to equipment lines.
3. Unless noted, nameplates shall be attached with sheet metal screws or epoxy cement. Epoxy cement shall not be used on equipment installed outdoors.
4. Coordinate with Owner for nameplate designations. Submit a complete itemized listing of nameplate equipment designations for approval.

E. Labeling

1. Piping labeled with directional arrows on any pressurized water system.

****END OF SECTION****

**SECTION 160030
HVAC PIPE AND PIPE FITTINGS**

PART 1 - GENERAL

1.1 WORK INCLUDED

- A. The Work of this Section shall consist of the labor, materials and equipment required for the installation of HVAC piping and pipe fittings.
- B. All cut piping shall be deferred before install (Pro Press, Victrolac)

PART 2 - PRODUCTS

2.1 PIPE AND PIPE FITTINGS

- A. Pipe shall conform to the materials specified herein, and shall be installed for piping systems as scheduled in Part 3 - Execution, of this Section.

2.2 TYPE L COPPER PIPE SPECIFICATION NO. 1

- A. Design Pressure: 150 psig.
- B. Maximum Design Temperature: 200 degrees F.
- C. Sizes 2 inches and smaller:
 - 1. Tubing: Type L hard drawn seamless copper tube, ASTM B88.
 - 2. Joints: Solder type with 95-5 solder, or press coupled. (Exception: All joints below ground shall be solder joints).
 - 3. Fittings: Wrought copper solder joint, ANSI B16.22 or cast bronze solder joint, ANSI B16.18, or with EPDM O-rings, ASME B16.18 or ASME B16.22, performance criteria of IAPMO PS 117.
- D. Sizes 2-1/2 inches and larger:
 - 1. Tubing: Type L hard drawn seamless copper tube, ASTM B88.
 - 2. Joints: Flanged and solder type with 95-5 solder or mechanically coupled grooved joints. (Exception: All joints below ground shall be solder joints.)
 - 3. Fittings: Wrought copper solder joint, ANSI B16.22 or cast bronze solder joint, ANSI B16.18, or mechanically coupled grooved joints.
 - 4. Flanges: 150 lb. class cast bronze, ANSI B16.24.

2.3 SCHEDULE 40 BLACK STEEL PIPE SPECIFICATION NO. 2

- A. Design Pressure: 125 psig.
- B. Maximum Design Temperature: 350 degrees F.
- C. Sizes 2 inches and smaller:
 - 1. Pipe: Schedule 40 black steel, threaded and coupled, ASTM A53.
 - 2. Joints:
 - a. Water: Threaded or mechanically coupled grooved joints.
 - b. Exception: All joints in piping installed below ground shall be welded.
 - 3. Fittings:
 - a. Water: 125 lb (S) - 175 lb (WOG) black cast iron, or mechanically coupled grooved fittings.
 - 4. Unions: 250 lb (S) - 500 lb (WOG) black malleable iron, ground joint with brass seat.
- D. Sizes 2-1/2 inches and larger:
 - 1. Pipe: Schedule 40 black steel, beveled ends, ASTM A53.
 - 2. Joints:
 - a. Water: Butt welded and flanged, or mechanically coupled grooved joints.
 - b. Exception: All joints in piping installed below ground shall be welded.
 - 3. Fittings:
 - a. Water: Schedule 40 seamless steel, butt weld type, ASTM A234, or mechanically coupled fittings.
 - b. Steam: Schedule 40 seamless steel, butt weld type, ASTM A234.
 - 4. Flanges: 150 lb forged steel, welding neck or slip on, ASTM A181 Class 60.
- E. All piping installed below ground shall have factory applied coal tar coating. Below ground joints shall have a field applied coal tar coating.

2.4 PRE-INSULATED UNDERGROUND PIPE SPECIFICATION NO. 8

- A. Acceptable Manufacturer: Rovanco, or Perma-Pipe.
- B. Design Temperature: 210 degrees F.
- C. All Pipe Sizes:
 - 1. Carrier Pipe: Black steel, standard weight, seamless, ASTM A106 or A53, Grade B or Yolo with steel butt welding fittings ASTM A234, Grade WPB.
 - 2. Insulation: Polyurethane foam filling the annular space between the carrier pipe and jacketing. Minimum thickness shall be 1 inch.
 - 3. Jacketing Material: High impact, seamless Polyvinylchloride (PVC) Class 12454-B, ASTM 1784, Type 1, Grade 1. 60 mils minimum thickness.

4. Fittings: Same size and materials as straight sections.
5. Terminal Ends: Watertight mastic end seal, factory or field applied.

D. Special Installation Requirements:

1. Manufacturer's field service instructor, technically qualified to determine that an installation is made in accordance with the manufacturer's recommendations, shall give instructions and make observations at the commencement of each new phase of the installation and during the test of the system. Upon completion of the installation the manufacturer shall deliver to Owner a signed certificate stating that the installation has been made in accordance with the manufacturer's recommendations.
2. Before any of the jacketing is closed and sealed, the carrier piping shall be tested.

2.5 FLEXIBLE PRE-INSULATED UNDERGROUND PIPE SPECIFICATION NO. 9

A. Acceptable Manufacturer: Acceptable Manufacturer: Rovanco Rhinoflex.

B. Design Pressure: 125 psig.

C. Design Temperature

1. Polyethylene (Chilled Water): 110 degrees F.

D. All Pipe Sizes (3/4 inch to 4 inch):

1. Inner Piping (Hot Water): Crosslinked PEX, with oxygen diffusion barrier.
2. Insulation: Pre-insulated, polyurethane closed cell.
3. Outer Casing: Polyethylene, seamless, corrugated.
4. Lengths: Continuous up to 1000 feet.
5. End Seals: Polyethylene.

E. Expansion: The pipe system shall be flexible type and all components including carrier pipe, insulation, and jacket shall be capable of expansion and contraction without overstressing or adversely affecting materials. The pipe system shall be installed per manufacturer's instructions so expansion loops and compensators are not required.

F. Special Installation Requirements:

1. Manufacturer's field service instructor, technically qualified to determine that an installation is made in accordance with the manufacturer's recommendations, shall give instructions and make observations at the commencement of each new phase of the installation and during the test of the system. Upon completion of the installation the manufacturer shall deliver to Owner a signed certificate stating that the installation has been made in accordance with the manufacturer's recommendations.
2. Before any of the outer casing is closed and sealed, the inner piping shall be tested.

PART 3 - EXECUTION

3.1 APPLICATION

- A. Piping systems shall be installed in accordance with the following pipe schedule(s).

PIPE SCHEDULE		
Service	Application	Pipe Spec. No.
Chilled Water	All	1 or 2
	Below Grade	8 or 9
Condensate Drainage, Cold	All	1
Heating Hot Water	All	1 or 2

3.2 INSTALLATION

- A. All pipe and fittings shall be carefully inspected for defects in workmanship prior to installation. Any item found unsuitable, cracked, or otherwise defective shall be rejected and removed from the jobsite. All pipe and fittings shall have factory applied markings, stampings, or nameplates with sufficient data for identification to determine their conformance with specified requirements.
- B. During construction all openings in piping shall be kept closed except when actual work is being performed on that item. Closures shall be plugs, caps, blind flanges, or other items specifically intended for this purpose. Exercise all necessary care to prevent foreign objects from entering material.
- C. Run pipe lines straight and true, parallel to building lines with a minimum use of offsets and couplings. Use full and double lengths of pipe wherever possible.
- D. Changes in direction shall be made only with pipe bends or fittings. Changes in size shall be made with fittings only. All fittings shall be of the long radius type, unless otherwise specified. Changes in direction on drainage pipe systems shall be made with wye fittings, combination wye and eighth bends, or one-eighth bends.
- E. Provide flanges or unions at all final connections to equipment, traps and valves to facilitate dismantling.
- F. Unless otherwise indicated, install all supply piping to coils, pumps and other equipment at line size with reduction in size being made only at inlet to control valve or pump. Install supply piping from outlet of control valve at full size of connection in equipment served. Install piping

in equipment outlet or return lines beyond dirt pockets the size of tapping in the trap or, if no trap, the size of the equipment connection.

- G. All pipe shall be cut to exact measurement, and installed without springing or forcing. Particular care shall be taken to avoid creating, even temporarily, undue loads, forces or strains on valves, equipment or building elements with piping connections or piping supports.
- H. Unless otherwise indicated, branch take-offs shall be from top of mains or headers at either a 45 degree or 90 degree angle from the horizontal plane for steam lines, and from top, bottom or side for liquids.
- I. Pipe joints connecting dissimilar metals shall be insulating, dielectric connections. Copper tubing shall be protected from electrolysis at contact points with ferrous metals, including temporary methods of support, by use of insulating, non-conductive spacers such as rubber, fiberglass or an approved equal. Pipe hangers for bare copper tubing shall be copper plated.
- J. Underground pressure piping shall be provided with concrete anchors and thrust blocks at ends of runs and changes in direction.
- K. All piping additions shall be tested/passed by appropriate parties before turning into the existing system.

3.3 PIPE JOINTS

A. Press Joints:

- 1. Copper and copper alloy press connections shall be made in accordance with the manufacturer's installation instructions.
- 2. Copper press fittings shall be installed using the proper tools, actuator, jaws and rings as instructed and approved by the press fitting manufacturer.
- 3. Installer shall be a qualified installer, licensed within the jurisdiction, and familiar with the installation of copper press joint systems.
- 4. Follow all installation instructions of manufacturer of press-joint fitting to ensure quality, leak-tight seal.
- 5. Provide unions and arrangement of sufficient length of removable sections of tubing at valves and equipment connections to allow for easy removal and reinstallation for repairs without having to redo press connections.

B. Mechanically Coupled Grooved Joints:

- 1. All grooved piping shall be installed and supported in strict adherence to the grooved manufactures installation and pipe supporting instructions.
- 2. Select proper gasket material that is compatible with fluid requirements.
- 3. Gasket lubricant shall be from the same manufacture as the couplings.
- 4. Pipe shall be grooved to manufactures recommended specifications.
- 5. Grooving tools shall be from the same manufacture as the couplings.
- 6. All couplings, fittings, flanges, valves and accessories shall be from the same manufacturer. All grooved piping products (i.e. couplings, fittings, valves and accessories) used on hot water systems shall have a temperature rating of at least 250 degrees F.

7. All couplings used up to and including 24 inches shall have a minimum pressure rating of 350 PSI.
8. All couplings shall be the rigid design except as needed or required.
9. All castings shall be date stamped for quality assurance and traceability.
10. The grooved mechanical coupling manufacturer shall have a factory trained field representative to be available to visit the job site. That representative shall provide training for contractor's field personnel, and view installed product to promote conformance to installation requirements, if requested by the Owner or Architect. The name and contact information of that representative should be part of the submittal package.

C. Solder Joints:

1. Make up joints with 95 percent tin and 5 percent antimony (95-5) solder conforming to ASTM B32 Solder Metal, Grade 95TA.
2. Cut copper tubing so ends are perfectly square and remove all burrs inside and outside.
3. Thoroughly clean sockets of fittings and ends of tubing to remove all oxide, dirt, and grease just prior to soldering.
4. Apply flux evenly, but sparingly, over all surfaces to be joined. Heat joints uniformly to proper soldering temperature so solder will flow to all mated surfaces. Wipe excess solder, leaving a uniform fillet around cup of fitting. Flux shall be non acid type.
5. Remove composition discs from solder end valves during soldering.
6. 2 ½ or larger copper fittings shall be tinned before soldering.

D. Welded Joints:

1. The welding of all pipe joints, both as to procedures and qualification of welders, shall be in accordance with Section IX, ASME Boiler & Pressure Vessel Code, unless mandatory local codes take precedence.
2. Ends of pipe and fittings to be joined by butt welding shall be beveled, cleaned to bare metal and internal diameters aligned before tack welding.

E. Threaded Joints:

1. Pipe screw threads shall conform to ANSI B16.3, Malleable Iron Threaded Fittings or ASTM B687, Brass, Copper, and Chromium-Plated Pipe Nipples.
2. Ream pipe ends and remove all burrs and chips formed in cutting and threading.
3. Protect plated pipe and brass valve bodies from wrench marks when making-up joint.
4. Apply thread lubricant to male threads only.

F. Flanged Joints:

1. Steel pipe flanges shall conform to ANSI B16.5, Steel Pipe Flanges and Flanged Fittings. Cast iron pipe flanges shall conform to ANSI B16.1, Cast Iron Flanges and Flanged Fittings.
2. Steel flanges shall be raised face except when bolted to flat cast iron flange.
3. Bolting for services up to 500 degrees F. shall be ASTM A307, Grade B with square head bolts and heavy hexagonal nuts conforming to ANSI B18.2.1, Square and Hex Bolts and

B18.2.2, Square and Hex Nuts. Set flange bolts beyond finger tightness with an indicating torque wrench to insure equal tension in all bolts. Tighten bolts such that those 180 degrees apart or directly opposite are torqued in sequence.

4. Gaskets for flat face flanges shall conform to requirements for Group I Gaskets in ANSI B16.5. Unless otherwise specified, gaskets shall be 3/32 inch thick.

****END OF SECTION****

**SECTION 160040
HVAC PIPING SPECIALTIES**

PART 1 - GENERAL

1.1 WORK INCLUDED

- A. The Work of this Section shall consist of the labor, materials, and equipment required for the installation of HVAC piping specialties.

1.2 SUBMITTALS

- A. Submit for approval in accordance with specified submittal procedures:
 - 1. Y-Type Strainers
 - 2. Branch Connections
 - 3. Pipe & Valve Identification
 - 4. Flexible Pipe Connectors
 - 5. Dielectric Connections
 - 6. Thermometers, including scale range
 - 7. Pressure Gages, including scale range
 - 8. Pressure/Temperature (P/T) Test Plugs
- B. Product Data: Submit manufacturer's technical product data for each type of measuring instrument. Submit schedule showing manufacturer's model number, scale range, location, and accessories for each type and application.

PART 2 - PRODUCTS

2.1 Y-TYPE STRAINERS, WATER PIPING

- A. Acceptable Manufacturer: Apollo (Conbraco), Armstrong International, Hoffman Specialty ITT, Metraflex Co., Spirax Sarco, or Watts Regulator Co
- B. Provide strainers full line size of connecting piping, with ends matching piping system materials. Strainers shall be Y-pattern type having 304 stainless steel screens with perforations/mesh sizes as follows:

<u>Pipe Size</u>	<u>Coarse Straining</u> (typically at central Plant equipment)	<u>Medium Straining</u> (typically at terminal/ control equipment)
1/4 " to 2"	1/16"	1/32" or 20 mesh

<u>Pipe Size</u>	<u>Coarse Straining</u> (typically at central Plant equipment)	<u>Medium Straining</u> (typically at terminal/ control equipment)
2-1/2" to 4"	1/8"	1/16"
5" and larger	3/16"	1/8"

C. Type WST-1

1. 2 inches and smaller, threaded ends.
2. Cast-iron or bronze body, screwed screen retainer with centered blowdown fitted with drain plug.
3. Pressure: 400 psig (WOG).

D. Type WST-2

1. 2-1/2 inches and larger, flanged ends.
2. Cast-iron or steel body, bolted screen retainer with off-centered blowdown fitted with hose end drain valve.
3. Pressure: 175 psig (WOG).

E. Type WST-3

1. Grooved Ends, 2-1/2 inches and larger, grooved ends.
2. Steel, ductile-iron or malleable-iron body and access end cap with off-center blowdown fitted with hose end drain valve.
3. Pressure: 175 psig (WOG)

2.2 BRANCH CONNECTIONS

- A. Branch connections shall be made with standard tee of the type required for the service unless otherwise specified or detailed.
- B. At Contractor's option, branch connections from headers and mains may be cut into black steel pipe using forged weld-on fittings. Weld-on fittings shall conform to chemical and physical requirements of ASTM A-234 and design and installation requirements of ANSI B31.1.
- C. Weld-on fittings shall have a pressure rating equal to, or greater than, the maximum working pressure of the pipe system where they are installed.
 1. Acceptable Manufacturer: Allied Piping Products Co. Branchlets (Shaped nipples), or Bonney Forge Weldolet & Thredolet.
- D. At Contractor's option, branch connections from headers and mains may be cut into copper tube using mechanically extracted collars. Collars shall be formed in a continuous operation consisting of drilling a pilot hole and drawing out the tube surface to form a collar having a height of not less than three times the thickness of the tube wall. Main pipe shall be vacuumed to clear all debris during collar forming procedure. Branch pipe shall be notched to conform with the inner curve of the run tube and dimpled to insure penetration of the branch pipe into the

collar at sufficient depth for brazing. All joints shall be brazed. Mechanical formed branch collars shall be UL listed.

1. Acceptable Manufacturer: T-Drill, Division of Serlachius.

2.3 ESCUTCHEON PLATES

- A. Plates shall be installed on all pipes and conduit passing through floors, walls, partitions, etc., in exposed areas.
- B. Plates installed on pipe passing through core drilled openings in solid concrete without sleeves shall be solid ring, cast iron with one set screw for sizes up to 4 inches and two set screws for sizes up to 8 inches.
- C. Plates installed on pipe and conduit passing through openings with sleeves shall be solid ring, cast iron.

2.4 PIPE AND VALVE IDENTIFICATION

- A. Acceptable Manufacturer: W. H. Brady Company, or Seton Nameplate Corp., Brimar Industries.
- B. Shutoff valves and control equipment shall be marked by means of a brass or plastic disc minimum of 1 inch in diameter fastened to valve wheel or stem by brass wire or chain. Each disc shall have a legibly marked identification number. A typewritten chart listing all valve tags, location, and service shall be included in the operating and maintenance manual. The valve chart numbering sequence shall be approved by Owner.
- C. All piping installed as Work of this Division shall be identified by legend and flow arrow. Identification system shall conform to ANSI A-13.1. Identification markers shall use ANSI standard background colors and be text size. Markers shall be attached to pipe by wrapping with color coded banding tape. Markers shall be located as follows:
 1. Near each valve and control device.
 2. Near each branch connection, excluding short takeoffs for fixtures and terminal units. Where flow pattern is not obvious, mark each pipe at branch.
 3. Near penetrations through walls, floors, ceilings, and nonaccessible enclosures.
 4. At access doors, manholes, and similar access points that permit view of concealed piping.
 5. Near major equipment items and other points of origination and termination.
 6. Spaced at maximum intervals of 25 feet along each run.

2.5 FLEXIBLE PIPE CONNECTORS

- A. Metal Hose Type
 1. Acceptable Manufacturer: Flexonics, or Keflex, Metraflex, Flex-Hose.

2. Connectors shall be constructed of a stainless steel corrugated core covered with high tensile tubular braiding. Ends for piping 2 inches and smaller shall be screwed or solder joint as required. Ends for piping 2-1/2 inch and larger shall be flanged.

B. Double Sphere Type

1. Acceptable Manufacturer: Thermo Tech Type F/F/DS, or as approved.
2. Style: Molded twin/double sphere.
3. Material
 - a. Body: Molded heat-resistant rubber with nylon reinforcement.
 - b. Flanges: Carbon steel 150#
4. Rating: 150 psig at 230 degrees F.
5. Control/retaining rods or wire rope to prevent over extension on unanchored systems.

2.6 DIELECTRIC CONNECTIONS

- A. Pipe joints connecting dissimilar metals shall be insulating, dielectric connections. Dielectric connections shall also be furnished for joining similar metals in order to isolate cathodically protected pipelines from adjoining pipe sections. Such joints, including dielectric material, shall be rated to withstand the temperature, pressure, and other characteristics of the service for which it is to be used, including testing pressure.
- B. Screwed joints shall be made with insulating unions.
 1. Acceptable Manufacturer: Watts, or Stockham Valves & Fittings.
- C. Flanged joints shall be made up with insulating gaskets, bolt sleeves, and washers.
 1. Acceptable Manufacturer: Watts.

2.7 THERMOMETERS, LIQUID IN GLASS

- A. Acceptable Manufacturer: Ashcroft Inc., or Ernst Flow Industries, Marsh Instruments, Miljoco Corporation, Terice, H.O. Co., Weiss Instruments Inc., Weksler.
- B. General: Provide stem type glass thermometers, per Standard ASME B40.200, of materials, capacities, and ranges indicated, designed and constructed for use in service indicated.
- C. Case: Die cast aluminum finished in baked epoxy enamel, glass front, spring secured, 9 inches long, acrylic or glass window face.
- D. Adjustable Joint: Die cast aluminum, finished to match case, 180 degree adjustment in vertical plane, 360 degree adjustment in horizontal plane, with locking device.
- E. Tube and Capillary: Glass with magnifying lens, blue or red organic liquid (non-mercury), 1 percent scale range accuracy, shock mounted.
- F. Scale: Satin faced, non-reflective aluminum, permanently etched markings.

- G. Stem: Copper-plated steel, aluminum, or brass, for separable socket, length to suit installation.
 - 1. Design for Thermowell Installation: Bare stem.
 - 2. Design for Air-Duct Installation: With ventilated shroud.
- H. Accuracy: Plus or minus 1 percent of scale range or one scale division, to a maximum of 1.5 percent of scale range.
- I. Range: Full scale range shall be selected to be approximately 1.33 to 2.0 times the normal maximum operating temperature. Use the following ranges as a guide.
 - 1. Chilled Water (40-75 degrees F max): 0 – 100 degrees F with 1degree F scale divisions.
 - 2. Hot Water (120-180 degrees F max): 30 – 240 degrees F with 2 degrees F scale divisions.
 - 3. Conditioned Air Ducts: 0 to 160 degrees F with 2 degrees F scale divisions.
- J. Thermowells:
 - 1. Standard: ASME B40.200.
 - 2. Description: Pressure-tight, socket-type fitting made for insertion into piping tee fitting.
 - 3. Material for Use with Copper Tubing: Brass
 - 4. Material for Use with Steel Piping: Brass or Stainless Steel.
 - 5. Bore: Diameter required to match thermometer bulb or stem.
 - 6. Insertion Length: Length required to match thermometer bulb or stem.
 - 7. Lagging Extension: Include on thermowells for insulated piping and tubing.
 - 8. Bushings: For converting size of thermowell's internal screw thread to size of thermometer connection.
 - 9. Heat-transfer compound: Used to improve thermal transfer and to eliminate condensation forming within the thermowell. Compound shall consist of synthetic, efficient thermally conductive ceramic or metal oxides in a homogeneous, non-hardening paste with negligible bleed and evaporation loss. Compound shall not cause catalytic corrosion between probe material and thermowell).
- K. Duct-Thermometer Mounting Brackets: Flanged bracket with screw holes, for attachment to air duct and made to hold thermometer stem.

2.8 PRESSURE GAGES

- A. Acceptable Manufacturer: Ashcroft Inc., or Ernst Flow Industries, Marsh Instruments, Miljoco Corporation, Trerice, H.O. Co., Weiss Instruments Inc., Weksler.
- B. General: Provide pressure gages of materials, capacities, and ranges indicated, designed and constructed for use in service indicated.
- C. Type: General HVAC grade, 1 percent accuracy, ANSI B40.1 grade A, glycerine filled phosphor bronze bourdon type, rotary brass movement with front recalibration adjustment bottom connection.

- D. Case: Aluminum or nylon, glass (or acrylic) lens, 4-1/2 inches diameter.
- E. Connector: Brass with 1/4 inch male NPT. Provide protective syphon when used for steam service.
- F. Scale: White coated aluminum, with permanently etched black markings.
- G. Set Hands: Where pressure gages are indicated for use across pump suction diffusers or straining / filter devices, provide adjustable set hands to indicate recommended pressure ranges of system.
- H. Range: Select for normal operating pressure to be approximately mid range of scale with full scale range shall be selected to be approximately 1.5 to 2.5 times the normal maximum operating pressure. The following typical ranges are suggested.
 - 1. Water:
 - a. 0 - 15 psig (between 2 to 10 psig max operating pressure)
 - b. 0 - 30 psig (between 10 to 20 psig max operating pressure)
 - c. 0 - 60 psig (between 20 to 40 psig max operating pressure)
 - d. 0 - 100 psig (between 40 to 60 psig max operating pressure)
 - e. 0 - 160 psig (between 60 to 100 psig max operating pressure)
 - f. 0 - 200 psig (between 100 to 130 psig max operating pressure)
 - g. 0 - 300 psig (between 130 to 200 psig max operating pressure)
- I. Gage Attachments
 - 1. Snubbers: ASME B40.100, brass; with 1/4 inch NPT, ASME B1.20.1 pipe threads and porous-stainless steel filter-type surge-dampening device. Include extension for use on insulated piping.
 - 2. Siphons: Loop-shaped section of brass (for normal operating pressure/temperature up to 200 psi, 325 degrees F) or stainless-steel (for normal operating pressure/temperature greater than for brass) pipe with 1/4 inch NPT pipe threads.
 - 3. Ball Valves: Selected for working pressure suitable for application, with 1/4 inch NPT, ASME B1.20.1 pipe threads.

2.9 PRESSURE/TEMPERATURE (P/T) TEST PLUGS

- A. Acceptable Manufacturer: Peterson Equipment Co., or Sisco, Watts Regulator.
- B. Construction: Brass with NPT fitting and self-sealing, dual valve core type Nordel gasketed orifice suitable for inserting 1/8 inch O.D. probe assembly from dial type insertion thermometer or pressure gage. Equip orifice with gasketed screw cap and chain.
- C. Pressure Rating: 500 psi and 275 degrees F.
- D. Size: 1/4 inch NPT for installation in pipe sizes through 2 inches. 1/2 inch NPT for installation in pipe sizes 2-1/2 inches and larger
- E. Provide extension of length equal to insulation thickness for insulated piping.

F. Accessories

1. Provide one system test kit consisting of one 2-1/2 inch dial face gage 0 to 200 psig, one 1 inch dial face thermometer 0 to 220 degrees F., one 1 inch dial face thermometer 50 to 500 degrees F., one 1/8 inch OD stainless steel gage adapter, and carrying case.

PART 3 - EXECUTION

3.1 INSTALLATION

- A. Contractor shall carefully follow the Drawings in laying out and installing his work. He shall not deviate therefrom, except for structural or interior finish interferences, and then only upon Architect's approval.
- B. All equipment and accessories shall be carefully inspected for defects in workmanship prior to installation. Any item found unsuitable, cracked, or otherwise defective shall be rejected and removed from the jobsite. All equipment shall have factory applied markings, stampings, or nameplates with sufficient data for identification to determine their conformance with specified requirements.
- C. Piping specialties shall be installed in accordance with the equipment manufacturer's recommendations. A manufacturer's representative shall certify, in writing, any equipment installation requested by Architect.
- D. During construction all openings in equipment shall be kept closed except when actual work is being performed on that item. Closures shall be plugs, caps, blind flanges, or other items specifically intended for this purpose. Exercise all necessary care to prevent foreign objects from entering material.
- E. Provide flanges or unions at all final connections to equipment and traps to facilitate dismantling.
- F. Install strainers in horizontal piping, full size of pipe, in accordance with manufacturer's installation instructions and as follows:
 1. Water Piping:
 - a. Install with screen pocket pointing downwards.
 - b. Where installation in horizontal piping is not possible, install in vertical piping with the flow downwards. Installation with upward flow is prohibited.
 2. Install pipe nipple and hose end drain valve in strainer blowdown connection, full size of connection, except for strainers 2 inches and smaller installed ahead of temperature control valves feeding individual terminals.
 3. Where indicated on Drawings, provide drain line from drain valve to plumbing drain, full size of blowdown connection.
 4. Where strainers are installed in pipe branches serving multiple terminals rather than at each individual terminal, provide isolation valves on each side of the strainer to allow for routine blowdown service without draining the piping system.

5. Replace any temporary fine mesh start-up screens if used during initial cleaning and flushing of systems.
- G. Unless otherwise indicated, branch take-offs shall be from top of mains or headers at either a 45 degree or 90 degree angle from the horizontal plane for steam, air, or gas lines and from top, bottom, or side for liquids.
- H. Pipe joints connecting dissimilar metals shall be insulating dielectric connections. Copper tubing shall be protected from electrolysis at contact points with ferrous metals, including temporary methods of support, by use of insulating non conductive spacers such as rubber, fiberglass, or an approved equal. Pipe hangers for bare copper tubing shall be copper plated.
- I. Thermometers shall be installed in locations where they are easily read from normal operating level. Install thermometers in piping systems in wells in short couplings. Enlarge pipes smaller than 2-1/2 inch for installation of thermometer wells. Ensure wells allow clearance from insulation. Fill voids between thermowell and thermometer and sensor stems with heat conducting compound before installing in wells.
- J. Pressure gages shall be installed vertically in locations where they are easily readable from normal operating level. Pressure gages installed in water systems shall be installed with a ball valve.
- K. Install pressure/temperature test plugs in piping tee where required to allow for balancing and troubleshooting without requiring permanent pressure gages and thermometers. Position on pipe at most accessible and readable position.
- L. Adjust gages and thermometers to final angle, clean windows and lenses, and calibrate.
 1. Adjusting: Adjust faces of meters and gages to proper angle for best visibility.
 - a. For gages on straining/filtering devices, adjust set hands on pressure gages to accurately indicate when service is required (approximately 50% above pressure differential when clean (or as otherwise recommended by strainer/filter manufacturer).
 - b. After installation, zero and/or calibrate meters and gages according to manufacturer's written instructions.
 2. Cleaning: Clean windows of meters and gages and factory-finished surfaces. Replace cracked or broken windows, repair any scratched or marred surfaces with manufacturer's touch-up paint.

END OF SECTION

SECTION 160050 HVAC VALVES

PART 1 - GENERAL

1.1 WORK INCLUDED

- A. The Work of this Section shall consist of the labor, materials and equipment required for the installation of HVAC valves.

1.2 SUBMITTALS

- A. Submit for approval in accordance with specified submittal procedures:
 - 1. Valves

PART 2 - PRODUCTS

2.1 VALVES

- A. Furnish and install valves as specified herein and as scheduled in Part 3 – Execution, of this Section. Insofar as possible all valves shall be of a single manufacturer.
- B. Packings, gaskets, discs, seats, diaphragms, lubricants, etc., shall conform to recommendations of the valve manufacturer for the intended service.
- C. If space permits, install valves with stems horizontal or extending vertically upward unless specifically shown otherwise. Valves shall be installed in accessible locations for operation as well as for removal, repair, or replacement.
- D. Valves installed in Insulated Piping: With stem or neck extensions of sufficient length to accommodate insulation thickness and the following features:
 - 1. Gate Valves: With rising stem.
 - 2. Ball Valves: With extended operating handle of non-thermal-conductive material, and protective sleeve that allows operation of valve without breaking the vapor seal or disturbing insulation.
 - 3. Butterfly Valves: With extended neck.
- E. Provide Owner with one operating wrench for every ten (10) valves of each type (but not less than 2 wrenches) not equipped with handwheels or levers.
- F. Valve body materials shall be compatible with piping system materials.
- G. Valves shall have right-handed threads.
- H. Valves shall conform to the following schedules:

BALL VALVE SPECIFICATIONS

Type	Size	Press. psig	Description	Acceptable Manufacturer
BA-1	thru 2"	150S 400WOG	Threaded ends; Bronze breakdown style body; Stainless steel ball; Full port; Teflon seats	Anvil International Apollo Nibco

BALANCING VALVE SPECIFICATIONS

Type	Size	Press. psig	Description	Acceptable Manufacturer
BL-1	thru 2"	125S	Threaded ends; Bronze body; Square head plug cock	A. Y. McDonald

BUTTERFLY VALVE SPECIFICATIONS

Type	Size	Press. psig	Description	Acceptable Manufacturer
BF-1	2-1/2" thru 12"	150WOG	Wafer type flange; Cast or ductile iron body; Ductile iron disc; EPT or EPDM seat; Stainless steel stem; Thru 6"-10 position locking lever handle; 8"-12"-Weatherproof gear operator	Anvil International Crane Milwaukee Nibco Stockham
BF-2	2-1/2" thru 12"	150WOG	Lug type flange; Cast or ductile iron body; Stainless steel disc; EPT or EPDM; Stainless steel stem; 10-position locking lever handle (thru 6"); Weatherproof gear operator (8"-12")	Anvil International Crane Milwaukee Nibco Stockham

CHECK VALVE SPECIFICATIONS

Type	Size	Press. psig	Description	Acceptable Manufacturer
CK-1	thru 2"	150S	Threaded ends; Bronze body; Regrinding swing type	Anvil International, Crane, Hammond, Milwaukee, Nibco
CK-2	thru 2"	125S 200WOG	Soldered ends; Bronze body; Renewable bronze disc swing type	Anvil International, Crane, Hammond, Milwaukee, Nibco
CK-3	2-1/2" thru 12"	125S 200WOG	Flanged ends; Iron body; Bronze trim; Bronze disc swing type	Anvil International, Crane, Hammond, Milwaukee, Nibco
CK-4	2-1/2" thru 12"	Class 125 200WOG	Flanged ends; Cast iron body; Bronze seat; Bronze disc; Stainless steel spring (non- slam)	Milwaukee, Nibco

GATE VALVE SPECIFICATIONS

Type	Size	Press. psig	Description	Acceptable Manufacturer
GA-1	thru 2"	125S 200WOG	Threaded ends; Bronze body; Rising stem; Solid wedge disc	Anvil International, Crane, Hammond, Milwaukee, Nibco

GATE VALVE SPECIFICATIONS

Type	Size	Press. psig	Description	Acceptable Manufacturer
GA-2	thru 2"	125S 200WOG	Soldered ends; Bronze body; Rising stem; Solid wedge disc	Anvil International, Crane, Hammond, Milwaukee, Nibco
GA-3	2-1/2" thru 12"	125S 200WOG	Flanged ends; Iron body; Bronze trim; OS&Y	Anvil International, Crane, Hammond, Milwaukee, Nibco

GLOBE VALVE SPECIFICATIONS

Type	Size	Press. psig	Description	Acceptable Manufacturer
GL-1	thru 2"	120S 300WOG	Threaded ends; Bronze body; Non-metallic disc	Anvil International, Crane, Hammond, Milwaukee, Nibco
GL-2	thru 2"	125S 200WOG	Soldered ends; Bronze body; Bronze or non- metallic disc	Anvil International, Crane, Hammond, Milwaukee, Nibco
GL-3	2-1/2" thru 10"	125S 200WOG & 450 Deg. F.	Flanged ends; Iron body; Bronze trim; Rising stem; Bronze or bronze faced iron disc	Anvil International, Crane, Hammond, Milwaukee, Nibco

PART 3 - EXECUTION

3.1 APPLICATION

- A. Valves shall be installed in accordance with the following valve schedule:

VALVE SCHEDULE			
Piping System	Valve Service		
	Shut-off	Balancing	Check
Heating Hot Water/ Chilled Water	BA-1 GA-1, GA-2, GA-3, BF-2	GL-1, GL-2, GL-3 BF-1, BL-1 (1)	CK-1, CK-2, CK-3, CK-4 (2)

Note 1: Balancing valve BL-1 to be used in coil piping bypass only. Refer to Section 235710, Heat Transfer for venturi balancing valves.

Note 2: Install non-slam check valves in pump discharges.

3.2 INSTALLATION

- A. All valves shall be carefully inspected for defects in workmanship prior to installation. Any item found unsuitable, cracked, or otherwise defective shall be rejected and removed from the job site. All valves shall have factory applied markings, stampings, or nameplates with sufficient data for identification to determine their conformance with specified requirements.
- B. Provide flanges or unions at all final connections to valves to facilitate dismantling.
- C. Unless otherwise indicated, install all shutoff valves to coils, pumps and other equipment at line size with reduction in size being made only at inlet to control valve or pump. Install check valves and shutoff valves in equipment outlet or return lines beyond dirt pockets the size of tapping in the trap or, if no trap, the size of the equipment connection.
- D. Where possible, install valves with bonnets in an upright position.

END OF SECTION

**SECTION 160060
HVAC SUPPORTS AND ANCHORS**

PART 1 - GENERAL

1.1 WORK INCLUDED

- A. The Work of this Section shall consist of the labor, materials and equipment required for the installation of HVAC supporting devices.

PART 2 - PRODUCTS

2.1 HANGERS, INSULATED PIPING

- A. Acceptable Manufacturer: Anvil International, or Penn Pipe Hanger.
- B. Hangers used with insulated piping shall be sized to accommodate the pipe, and insulation and shall have a support shield to prevent the hanger from compressing the insulation. Hanger shall be clevis type with rod and two nuts or bolt and nut.

2.2 HANGERS, UNINSULATED PIPING

- A. Acceptable Manufacturer: Anvil International, or Penn Pipe Hanger.
- B. Hangers for uninsulated ferrous pipe shall be clevis type with rod and two nuts or bolt and nut.
- C. Hangers for uninsulated copper pipe shall be clevis type with bolt and nut and shall be copper plated.

2.3 HANGERS, ROLLER TYPE

- A. Acceptable Manufacturer: Anvil International, or Penn Pipe Hanger.
- B. Hangers for piping 4 inches and larger shall consist of a single pipe roll support with adjustable socket, rod and hex nuts, and an insulation shield. Where pipe insulation thickness requirements exceed allowable overall outside diameter for use with insulation shield, provide instead pipe insulation protection saddle, suitable for pipe insulation thickness specified.

2.4 INSERTS, POURED CONCRETE

- A. Acceptable Manufacturer: Anvil International, or Penn Pipe Hanger.
- B. Inserts shall have cast malleable iron body and nut with galvanized finish.

2.5 INSERTS, PRECAST OR CURED CONCRETE

- A. Acceptable Manufacturer: Hilti HSL, or as approved.
- B. A high integrity, torque controlled anchor for heavy duty fastenings. Loads shall not exceed manufacturer's recommended weight.

2.6 BEAM CLAMPS

- A. For pipe sizes of 3 inches and smaller:
 - 1. Acceptable Manufacturer: Anvil International, or Penn Pipe Hanger.
 - 2. Clamps for attachment to I-beams and/or steel joists shall be malleable iron C-clamp with hardened steel cup and point set screw and locknut.
- B. For pipe sizes of 4 inches and larger:
 - 1. Acceptable Manufacturer: Anvil International.
 - 2. Clamps for attachment to I-beams and/or steel joists shall be adjustable type with malleable iron jaw, steel tie rod, nuts, and washer.

2.7 PIPE RISER CLAMPS

- A. Acceptable Manufacturer: Anvil International, or Penn Pipe Hanger.
- B. Pipe riser clamps for both insulated and uninsulated vertical pipe risers shall be 2-piece clamp complete with 2 bolts and 2 nuts, sized for the OD of the bare pipe to be supported. Clamp shall be carbon steel construction with galvanized finish for ferrous pipe and copper plated for copper piping.

PART 3 - EXECUTION

3.1 INSTALLATION

- A. The requirements of the applicable Sections of ANSI B31, Pressure Piping shall be considered as minimum requirements governing fabrication, installation, and support of piping systems.
- B. All piping and piping connected equipment, including valves, strainers, traps, and other specialties and accessories shall be supported in a manner that will not result in excessive stress, deflection, swaying, sagging or vibration in the piping or in the building structure either during erection, cleaning, testing, or normal operation of the systems. Piping shall not be so restrained, however, as to cause it to snake or buckle between supports or anchors, or to prevent proper movement due to expansion and contraction. Piping shall be supported at equipment and valves such that they can be disconnected and removed without further supporting the piping. Piping shall not introduce any strains or distortion to the connected equipment.

- C. Hangers, riser clamps, and supports shall be installed complete, including locknuts, clamps, rods, bolts, couplings, swivels, inserts, and required accessory items. Hangers for horizontal piping shall have adequate means of vertical adjustment for proper alignment of pipe, and shall be provided with locknuts. All hangers, riser clamps, and supports in direct contact with copper piping shall be copper plated or plastic coated.
- D. Maximum spacing supports of horizontal piping shall be as listed below. Provide hanger rods in diameters recommended by hanger manufacturer.

<u>Pipe Size</u>	<u>Uninsulated Steel</u>	<u>Insulated Steel</u>	<u>Copper Tubing</u>
1/2"	7'	7'	5'
3/4"	7'	7'	5'
1"	7'	7'	5'
1-1/4"	7'	7'	6'
1-1/2"	9'	9'	8'
2"	10'	10'	8'
2-1/2"	11'	10'	9'
3"	12'	10'	10'
4"	12'	10'	10'
5"	12'	10'	10'
6"	12'	10'	10'
8"	12'	10'	10'

- E. Provide additional supports where pipe changes direction, adjacent to flanged valves and strainers, at equipment connections and heavy fittings. Provide at least one hanger adjacent to each grooved end steel pipe with mechanical couplings. Support vertical pipe with riser clamps installed below hubs, couplings or lugs welded to the pipe.
- F. Beam clamps shall be used to attach hanger rods to structural steel.

END OF SECTION

**SECTION 160070
HVAC SOUND AND VIBRATION CONTROL**

PART 1 - GENERAL

1.1 WORK INCLUDED

- A. The Work of this Section shall consist of the labor, materials, and equipment required for installation of sound and vibration control devices and materials to prevent sound transmission and vibration to the building structure.

1.2 RELATED SECTIONS

- A. Section 160020, HVAC Basic Materials: Piping and ductwork penetrations.
- B. Section 160040, HVAC Piping Specialties: Flexible pipe connectors.
- C. Section 160110, Air Distribution: Flexible duct connectors.

1.3 SUBMITTALS

- A. Submit for approval in accordance with specified submittal procedures:
 - 1. Isolators
 - 2. Bases
 - 3. Acoustical Treatment Materials
- B. Vibration Isolators and Bases: Submittal data shall show type, size, and deflection of each vibration isolator proposed. Steel bases and concrete inertia bases shall be completely detailed. Include clearly outlined procedures for installing and adjusting vibration isolators.
- C. Acoustical Treatment Materials: Submittal shall include construction details, materials, dimensions and attachment methods of individual components.

1.4 QUALITY ASSURANCE

- A. Vibration isolation devices, including auxiliary steel bases and pouring forms, shall be designed and furnished by a single manufacturer or supplier to assure single responsibility for performance of vibration isolators installed.

PART 2 - PRODUCTS

2.1 GENERAL

- A. Vibration isolators and bases for outdoor installations shall be suitably protected to prevent corrosion. Steel bases shall be primed and painted. Springs, nuts, bolts, etc., shall be cadmium plated and neoprene coated. Spring housings shall be neoprene coated.

2.2 ISOLATORS

A. Isolator Specification No. 1

1. Acceptable Manufacturer: Kinetics Noise Control Model FDS, or Amber/Booth, Vibration Mountings & Controls, Mason Industries, Vibration Eliminator Co.
2. Type: Free-standing spring isolator.
3. Description: Adjustable, free-standing, open spring mounting with combination leveling bolt and equipment fastening bolt. Spring rigidly attached to spring mounting baseplate and compression plate. A neoprene pad having a minimum thickness of 1/4 inch shall be bonded to the baseplate.
4. Design: Minimum K_x/K_y (horizontal-to-vertical spring rate) of 1.0 and shall fall into stable range as defined in the latest ASHRAE Systems Handbook.

B. Isolator Specification No. 5

1. Acceptable Manufacturer: Kinetics Noise Control Model SFH, or Amber/Booth, Vibration Mountings & Controls, Mason Industries, Vibration Eliminator Co.
2. Type: Hanger.
3. Description: A combination spring and elastomeric or fiberglass hanger consisting of a rectangular steel box, steel spring, and an elastomeric isolation element, with a neoprene or fiberglass construction.
4. Design: The elements shall be designed for approximately 1/4 inch deflection and loaded so that deflection does not exceed 15 percent of the free height of the element.

2.3 BASES

A. Base Specification No. 2

1. Acceptable Manufacturer: Kinetics Noise Control Model CIB, or Amber/Booth, Vibration Mountings & Control, Mason Industries, Vibration Eliminator Co.
2. Type: Concrete inertia base.
3. Description: Base shall consist of a perimeter steel pouring form with reinforcing bars welded in place, bolting templates with anchor bolts and height saving brackets for side mounting of spring isolators.
4. Design: Perimeter steel members shall have a minimum depth of 1/12 of the longest span, but not less than 6 inches deep. Base shall be sized with a minimum overlap of 4 inches around base of equipment and, in the case of belt driven equipment, 4 inches

beyond end of drive shaft. Bases for pumps shall be sized to support suction elbow of end suction pumps and both suction and discharge elbows of horizontal split case pumps. Bases shall be T-shaped where necessary to conserve space.

B. Base Specification No. 3

1. Acceptable Manufacturer: Kinetics Noise Control Model KSR, or Amber/Booth, Vibration Mountings & Controls, Mason Industries, Vibration Eliminator Co.
2. Type: Curb rail isolator.
3. Description: Isolator shall consist of a prefabricated extruded aluminum or a formed galvanized steel rail system, incorporating 1 inch deflection freestanding stable springs for vibration isolation, and a continuous air and water seal.
4. Construction: Rail sections shall include integral slot anchoring springs to the bottom section, but allow horizontal adjustment. Spring elements shall meet specified characteristics of spring isolators, specified herein, and shall be selected and located to maintain a level rail assembly and uniform spring deflection of 1 inch after equipment is installed. A continuous, integral, gravity, water seal and foam or neoprene air seal shall be incorporated into rail sections, allowing no metal contact between top and bottom sections.
5. Installation: Curb isolator assembly may be a one piece unitized assembly or may be provided in multiple sections, designed to fit the base of rooftop equipment and associated roof curb. Curb isolator shall have mitered corners with an integral alignment and connection facility for accurate joining of side and end assemblies. Curb isolators shall be field calked in accordance with instructions furnished by curb isolator manufacturer.

2.4 ACOUSTICAL TREATMENT MATERIALS

A. Acoustical Grade Calk

1. Acceptable Manufacturer: BRD Noise & Vibration Control, Inc. HSAC-100.
2. Material: Non-hardening, extruded latex bead, white in color.
3. Compliance: UL 723 and Class "A" per ASTM E-84.

B. Loaded Vinyl Sound Barrier

1. Acceptable Manufacturer: BRD Noise & Vibration Control, Inc. NRLV-100.
2. Material: High temperature-fused, non-reinforced vinyl loaded with non-lead fillers, 0.107 inch nominal thickness, 1.0 lbs/sq.ft..
3. Performance: Barrier shall exhibit a transmission loss not less than indicated below when tested in accordance with ASTM-E-90-75.

HZ	<u>125</u>	<u>250</u>	<u>500</u>	<u>1000</u>	<u>2000</u>	<u>4000</u>	<u>STC</u>
	13	17	22	26	32	37	26

C. High Density Acoustic Insulation

1. Acceptable Manufacturer: BRD Noise & Vibration Control, Inc. HB-200.
2. 2 inch thick batt insulation, nominal 3 lbs./cu.ft. density.
3. Performance: Insulation shall exhibit absorption characteristics not less than shown below in accordance with ASTM C-423-77.

HZ	<u>125</u>	<u>250</u>	<u>500</u>	<u>1000</u>	<u>2000</u>	<u>4000</u>	<u>NRC</u>
	0.07	0.27	0.96	1.13	1.08	0.99	0.85

PART 3 - EXECUTION

3.1 SYSTEM DESIGN

- A. Vibration isolation equipment manufacturer shall be responsible for proper selection of spring rates to accomplish the specified minimum static deflections for all spring and pad type isolators, based on weight distribution of equipment to be isolated.
- B. Vibration isolation equipment manufacturer shall be responsible for structural design of steel beam bases and concrete inertia bases to support mechanical equipment specified herein.
- C. Minimum spring deflections shall be selected in accordance with latest ASHRAE Systems Handbook, unless otherwise indicated on Drawings.

3.2 APPLICATION

- A. Vibration isolators and bases shall be installed in accordance with the following schedule:

VIBRATION ISOLATOR AND BASE SCHEDULE		
Application	Isolator Spec. No.	Base Spec. No.
Fan, Centrifugal Suspended	5	Not Req'd.
Pump, Base-mounted	1	2
Rooftop Air Handling Unit, Curb Mtd.*	n/a	3
Piping, Where Specified	5	n/a
Ductwork, Where Specified	5	n/a

* Isolators and bases are not required on air handlers with manufacturer furnished vibration isolation in motor/fan sections. Confirm with Engineer.

- B. Provide hanger isolators for piping over 1 inch OD located in mechanical equipment rooms, and for a minimum of 50 feet or 100 pipe diameters, whichever is greater, from connection to vibration isolated equipment.

- C. Provide hanger isolators for ductwork located in mechanical equipment rooms, and for a minimum of 50 feet from connection to vibration isolated air moving equipment.

3.3 INSTALLATION

- A. Installation of sound and vibration control equipment and materials shall be accomplished in accordance with the manufacturer's written instructions.
- B. Rigid connections shall not exist between equipment and building structure that will degrade the sound and vibration control system(s) specified herein.
- C. Sound and vibration control equipment and materials manufacturer, or his qualified representative, shall be responsible for providing such supervision as may be necessary to assure correct installation and adjustment of the sound and vibration control system. Upon completion of equipment installation and after the system is placed into operation, the manufacturer, or his representative, shall make a final inspection and submit a report to Owner in writing, certifying the correctness of the installation Specifications.
- D. Piping and ductwork to be vibration isolated shall freely pass through walls and floors without rigid connections. Penetration points shall be sleeved or otherwise formed to allow passage of piping or ductwork, and maintain a minimum of 3/4 inch and a maximum of 1-1/4 inch clearance around the outside surfaces. Refer to Section 160020, HVAC Basic Materials for procedures in sealing this annular space.
- E. Rooftop Air Handling Unit In-curb Acoustical Treatment
 1. Alternating layers of sound barrier and acoustic insulation shall line the top surface of the roof deck inside the curb to reduce the noise levels radiated inside the curb from the bottom of the rooftop unit to the occupied spaces below.
 2. Decking shall be maintained inside the curb to a clearance of 1/4 inch maximum around the duct drops but shall not contact the duct.
 3. Sound barrier shall be overlapped a minimum of 3 inches.
 4. Acoustic insulation seams shall be butted and insulation shall be packed in air gaps around duct drops.
 5. Seams for every layer shall be staggered.
 6. Acoustic grade caulk shall be applied in the following areas:
 - a. Around the entire curb interior perimeter.
 - b. Single bead at sound barrier overlaps.
 - c. Around duct drop penetrations through decking.

END OF SECTION

SECTION 160080 HVAC INSULATION

GENERAL

1.1 WORK INCLUDED

- A. The Work of this Section shall consist of the labor, materials and equipment required for insulating HVAC piping, ductwork and equipment.

1.2 SUBMITTALS

- A. Submit for approval in accordance with specified submittal procedures:
 - 1. Insulation Materials, including application thicknesses
 - 2. Sealants, Adhesives, Coatings

PART 2 - PRODUCTS

2.1 FIBERGLASS PIPE INSULATION SPECIFICATION NO. 1

- A. Acceptable Manufacturer: Johns Manville Micro-Lok AP-T Plus (indoor) Manville Micro-Lok w/Zeston 2000 PVC (outdoor), or Owens Corning Fiberglas SSLII/ASJ (indoor) Owens Corning Fiberglas SSLII/ASJ w/ Insul Coustic Metal Clad (outdoor).
- B. Material: Fiberglass pipe insulation with all-purpose vapor barrier jacket for indoor installations. For outdoor installations, insulation jacket shall be 20 mil PVC or 0.016 inch polished aluminum.
- C. Properties
 - 1. Maximum K Factor: 0.23 at 75 degrees F. mean.
 - 2. Temperature Range: 0 degrees F. to 850 degrees F.
 - 3. Fire Hazard: FHC 25/50 per ASTM E-84 and UL 723.
 - 4. For use on pipe sizes 1/2 inch to 12 inches.
- D. Seams and Joints: Self-sealing (pressure sensitive) lap seams and matching butt strips.
- E. Fittings
 - 1. Fiberglass batt inserts with premolded PVC jacket:
 - a. Acceptable Manufacturer: Johns Manville Zeston 2000 PVC, or Foster Speed-Line, Proto.
 - b. Properties: 0.28 max. K at 75 degrees F. mean, 0 degrees F. to 450 degrees F. temperature range, FHC 25/50 fire hazard per ASTM E-84.

2. Fitting insulation shall be same thickness as adjacent insulation.

2.2 FLEXIBLE ELASTOMERIC PIPE INSULATION SPECIFICATION NO. 2

- A. Acceptable Manufacturer: Armacell AP Armaflex w/520 BLV Adhesive and Armaflex WB Finish for outdoor installations, or Rubatex.
- B. Material: Flexible elastomeric thermal pipe insulation. Black in color. For outdoor installations, insulation shall be covered with glass fiber mesh embedded in insulation adhesive and painted with insulation manufacturer's standard protective finish.
- C. Properties
 1. Maximum K Factor: 0.27 at 75 degrees F.
 2. Compliance: ASTM E84, 25 flame/50 smoke.
 3. Temperature Range: Minus 70 degrees F. to 220 degrees F.
 4. For use on pipe sizes: 3/8 inch to 6 inch.
- D. Fittings, Joints: Mitered cut, same thickness as adjacent insulation.
- E. Adhesive: Toluene free, low VOC.

2.3 FIBERGLASS DUCT LINER INSULATION SPECIFICATION NO. 4

- A. Acceptable Manufacturer: Johns Manville Permacote Lina-coustic, or Certain-Teed ToughGard™, Owens-Corning Aeroflex Plus, Knauf Duct Liner E-M.
- B. Material: Fiberglass blanket duct liner.
- C. Properties
 1. Maximum K Factor: 0.26 at 75 degrees F. mean.
 2. Density: 1.5 or 2.0 pcf.
 3. Temperature Rating: 250 degrees F. (maximum)
 4. NFPA Requirements: Bulletin 90A and 90B.
 5. Compliance: ASTM E84, 25 flame/50 smoke.
- D. Coating for Duct Liner Butt Joints and Clip Fasteners
 1. Acceptable Manufacturer: Foster Sealfas Coating 30-36.
- E. Adhesive for Duct Liner Attachment
 1. Acceptable Manufacturer: Foster Spark-Fas 85-11, 85-22.

2.4 FIBERGLASS DUCT WRAP INSULATION SPECIFICATION NO. 5

- A. Acceptable Manufacturer: Johns Manville Microlite, or Certain-Teed Standard Duct Wrap, Owens-Corning Fiberglas All-Service Duct Wrap, Knauf.
- B. Material: Exterior fiberglass duct insulation with foil scrim kraft laminated (FSKL) facing.
- C. Properties
 - 1. Maximum K Factor: 0.29 at 75 degrees F. mean.
 - 2. Density: 1.0 pcf or 1.5 pcf.
 - 3. Temperature Rating: 250 degrees F. (maximum)
 - 4. NFPA Requirements: Bulletins No. 90A and 90B.
 - 5. Compliance: ASTM E84, 25 flame/50 smoke.
- D. Adhesive for Duct Insulation Attachment
 - 1. Acceptable Manufacturer: Foster Stic-Saf 85-15 or Spark-Fas 85 20.
- E. Tape for Sealing Duct Insulation Butt Joints, 2 inches Wide
 - 1. Acceptable Manufacturer: Elgen Air-Tite EDT-2.

2.5 FLEXIBLE ELASTOMERIC SHEET/ROLL INSULATION SPECIFICATION NO. 6

- A. Acceptable Manufacturer: Armstrong AP Armaflex w/520 Adhesive and Armaflex WB Finish for outdoor installations, or Rubatex.
- B. Material: Exterior flexible elastomeric thermal sheet or roll insulation. Black in color. For outdoor installations, insulation shall be covered with glass fiber mesh embedded in insulation adhesive and painted with insulation manufacturer's standard protective finish.
- C. Properties
 - 1. Maximum K Factor: 0.27 at 75 degrees F. mean.
 - 2. Compliance: ASTM E84, 25 flame/50 smoke.
 - 3. Temperature Rating: Minus 70 degrees F. to 220 degrees F.

2.6 FIBERGLASS BOARD/SHEET INSULATION SPECIFICATION NO. 8

- A. Acceptable Manufacturer: Johns Manville 800 Series, Spin-Glas, or Owens-Corning 700 Series Fiberglas, Certain-Teed CB-600, Knauf.
- B. Material: Flexible or non-flexible fiberglass board or sheet with all-purpose vapor barrier jacket. Insulation installed outdoors on ductwork shall be tapered on top of ductwork and wrapped and sealed with white EPDM.
- C. Properties

1. Maximum K Factor: 0.23 at 75 degrees F. mean.
2. Density: 6 pcf.
3. Temperature Rating: 0 degrees F. to 450 degrees F.
4. Compliance: ASTM E84, 25 flame/50 smoke.

2.7 HIGH TEMPERATURE FIREPROOFING WRAP INSULATION SPECIFICATION NO. 11

- A. Acceptable Manufacturer: Thermal Ceramics Firemaster Ductwrap, or as approved.
- B. Material: Foil encapsulated, non-combustible, high temperature, inorganic flexible fire proofing wrap materials.
- C. R-Value: 4.15 per inch.
- D. Ratings: Blanket 0 flame spread 0 smoke development rating per ASTM #84.
- E. Approvals: Tested and approved per ASTM E2336.

PART 3 - EXECUTION

3.1 APPLICATION

- A. Insulation shall be installed in accordance with the following insulation schedule(s). (Where more than one insulation type is scheduled, Contractor shall have the option of choosing from types listed.)

PIPE INSULATION SCHEDULE						
Service	Temp. Range Deg. F	Insul. Spec. No.	Minimum Pipe Insulation Thickness			
			to 1-1/2"	2"	2-1/2" to 4"	5" & larger
Hot Water	• 161	1	1-1/2	2	2	2
	100-160	1	1-1/2	2	2	2
		2	1-1/2	2	2	N/A
Chilled Water	40-55	2	1-1/2	1-1/2	1-1/2	1-1/2
Condensate Drainage	35-70	1	1/2	1/2	1/2	1
		2	1/2	1/2	1/2	1

DUCT INSULATION SCHEDULE

Duct Type/Service	Insulation Spec. No.	Thickness, Inches
Rectangular Sheet Metal, installed within building thermal envelope:		
Supply Air	4	1
Return Air	4	1
Exhaust Air, Upstream of Energy Recovery Equipment	4	1
Exhaust Air	Not Required	---
Outdoor Air	5	1-1/2
Relief Air	Not Required	---
Range Hood Exhaust	11	As required to meet ASTM E2336
Round Sheet Metal, installed within building thermal envelope:		
Supply Air	5	1-1/2
Return Air	5	1-1/2
Exhaust Air, Upstream of Energy Recovery Equipment	5	1-1/2
Exhaust Air	Not Required	---
Outdoor Air	5	1-1/2
Relief Air	Not Required	---

EQUIPMENT INSULATION SCHEDULE

Equipment	Insulation Spec. No.	Thickness, Inches
Chilled Water Pump Volute (Note 1)	6 8	1 1

NOTE 1: Provide removable insulation and aluminum jacket for pump volute.

3.2 INSTALLATION

A. General

1. Surface areas of all pipe and ducts to be insulated shall be clean and dry. Insulation shall not be installed until all tests and inspections of the specific system(s) are complete. , with the exception of duct liner installed during duct fabrication.
2. All pipe and duct insulation shall be continuous through wall and ceiling/floor penetrations except where specific sealing requirements are specified, i.e. fire-rated separations. Where pipes pass through fire-rated floors, walls, or partitions, the use of a UL approved system for through penetrations is required. The annular space around the pipes shall be packed with mineral wool or other noncombustible material and sealed at each exposed edge to maintain the rating of the system in accordance with the through penetration sealant manufacturer's recommendations.
3. Insulate all components in piping systems, including valve bodies, inline air separators, hangers, guides, anchors, and pump housings. Do not insulate traps, strainers, flexible connectors, or expansion compensators. Maintain access to all servicing points and nameplate data. Edges of vapor barrier insulation at valve stems, instrument wells, unions and other raw edges shall be adequately sealed to prevent moisture from penetrating the insulation.
4. Insulation on all cold surfaces shall provide a continuous unbroken vapor seal. Hangers, supports, anchors, etc., that are secured directly to cold surfaces shall be adequately insulated and vapor sealed to prevent condensation.
5. Adhesives, mastics, sealers, and coatings shall be applied at manufacturer's required ambient conditions and recommended minimum coverages.

B. Insulation Protective Shields

1. Insulation protection shields fabricated from galvanized steel shall be installed at all pipe hangers and supports. Shields shall span an arc of 180 degrees.
2. Provide shield lengths and thicknesses as outlined in the latest version of the International Mechanical Code or MSS-SP69. Minimum shield lengths shall be as follows:

Pipe Sizes, <u>Inches</u>	Shield Length, <u>Inches</u>
1-1/2 to 2-1/2	10
3 to 6	12
8 to 10	16
12 and over	22

3. Rigid cellular glass insulation, capable of resisting the crushing effect of the hydraulically loaded piping, shall be placed under each shield. Jacketing material shall be wrapped around rigid insulation and adjacent top and butt sections to maintain the jacketing continuity.
4. Stainless steel shields shall be installed on insulated piping located on the roof.

C. Fiberglass Pipe Insulation

1. All piping shall be cleaned of debris prior to installation of insulation and components. Joints shall be butted firmly together. Longitudinal laps and butt strips shall be securely fastened as recommended by the manufacturer.
2. Fittings, insulated with fiberglass blanket and PVC jacket shall be installed in accordance with insulation manufacturer's instructions. All butt joints between longitudinal pipe insulation and fittings shall be taped.

D. Flexible Elastomeric Thermal Pipe and Sheet Insulation

1. Insulation shall be installed neatly with oversized pipe insulation and sheet insulation being used for fittings and valves. For outdoor installations, completely wrap insulation surface with glass fiber mesh and fully adhere/lag glass mesh to insulation with one coat of insulation adhesive. Inspect for bonding of glass mesh to insulation surfaces before applying specified weatherproof finish. Consult insulation manufacturer's recommendations for coatings and sealants.

E. Duct Liner Insulation

1. Duct liner shall be applied to the flat duct sheet with a minimum of 90 percent coverage of adhesive.
2. Duct liner shall be cut to assure snug closing corner joints. The smooth surface of the liner shall face the air stream. On top and sides of duct having a width and/or height dimension over 15 inches, the liner shall be additionally secured with welded pins and speed clips or grip-nails on a maximum of 15 inch centers. Pins shall be cut close to the speed clip. Pins shall start within 2 inches of the leading edge of each section and within 3 inches of the leading edge of cross joints within the duct section. All exposed edges and joints of the liner shall have coating applied.

F. Duct Wrap Insulation

1. All insulation shall be applied with edges tightly butted. Insulation shall be secured with adhesive which shall be applied to entire metal surfaces so that insulation conforms to duct surfaces uniformly and firmly.

G. Fiberglass Board/Sheet Insulation

1. Insulation board/sheet shall be installed by means of weld pins or stick clips. Pins/clips shall be located a maximum of 3 inches from all leading edges and a minimum of 12 inches on center for remainder of surface area.
2. Removable heads, cover plates, manholes, etc., shall be separately covered with unfaced board/sheet with 1/2 inch insulating cement finish, leaving bolts and nuts accessible. Leave nameplates visible.

****END OF SECTION****

**SECTION 160090
VARIABLE FREQUENCY DRIVES**

PART 1 - GENERAL

1.1 WORK INCLUDED

- A. The Work of this Section shall consist of the labor, materials, and equipment required for installation of variable frequency drives for air handling units and pumps.
- B. Variable frequency drives shall serve as starter, circuit breaker, motor overload protection, indicator panel, remote signal output and power factor correction for the specific mechanical equipment.

1.2 SUBMITTALS

- A. Submit variable frequency drives for approval in accordance with specified submittal procedures. Include wiring diagrams, load characteristics, connections and mountings with submittal data.

PART 2 - PRODUCTS

2.1 VARIABLE FREQUENCY DRIVES

- A. Acceptable Manufacturers: ABB (Siemens) or Yaskawa.
- B. General: The drive shall accept three phase input.
 - 1. Suitable for operation on standard NEMA design B motors. Drive shall have a diode bridge rectifier on the input to minimize generation of electrical noise back into the line and provide near unity power factor.
 - 2. Drive horsepower rating shall range from 3 HP to 100 HP with a speed range of 3 to 67, 80 or 120 Hz selectable by rotary switch. Drive shall be capable of an overload of 120 percent for 60 seconds.
 - 3. Output devices shall be transistors, IGBT (insulated gate bipolar transistors) for reduced motor noise.
 - 4. UL listed.
- C. Environment Conditions
 - 1. Drive Enclosure Type: NEMA 1 (indoor) or NEMA 3R (outdoor); as required for the application. The enclosure shall provide protection of all internal components for the application and environmental conditions at the installed location.
 - 2. Drive shall be capable of operation under any combination of the following conditions without mechanical or electrical damage.

- a. Ambient Temperature: Minus 10 to 40 degrees C (14 to 104 degrees F), minus 10 to 50 degrees C (14 to 122 degrees F) without cover.
- b. Relative Humidity: Less than 90 percent non-condensing.
- c. Altitude: Less than 1,000m (3300 ft.) above sea level.
- d. Vibration: Less than 0.5 G for 20 to 50 Hz less than 0.1 mm (peak to peak) for 50 to 100 Hz.

D. Control

- 1. Control System: Sinusoidal pulse width modulated voltage waveform.
- 2. Output Voltage: 3 phase 380 to 460 volt.
- 3. Frequency Accuracy: Plus or minus 0.5 percent of maximum frequency.
- 4. Setting Frequency: 3 to 67 Hz internally selectable to 120 Range: Hz.
- 5. Volts/Hertz Ratio: 3 to 60 Hz V/Hz dependent on load (automatic) 60 Hz and up, voltage constant.
- 6. Operation frequency 0 to 67 Hz, internally selectable to 120 cy Range: Hz.
- 7. Overload Capacity: 120 percent for 60 seconds. A microprocessor shall monitor the load on the drive and in the event of an overload, it shall, based on the calculation of a true inverse time overload characteristic, either trip out or phase back the voltage and speed as selected by an internal jumper.

E. Digital Readout and Monitor: Four (4) each, seven (7) segment LED's shall display OFF, LOW SPEED, FREQUENCY and FAULT. Front accessible pushbutton shall permit user to monitor percent current, percent voltage, frequency, acceleration and deceleration time, input bias, input gain, upper and lower limit. Drive readout shall also provide drive status and protective circuits status.

F. Protection: Variable frequency drive system shall include a diode bridge rectifier, capacitor filter, and transistorized inverter section. Base driver signals to control firing of the power transistors shall be designed with optically coupled isolators for maximum protection of the control circuits from high voltage and noise. Output shall be a sinusoidal waveform, pulse width modulated, voltage waveform for reduced harmonic heating in the motor.

- 1. System protection, as a minimum, shall provide the following:
 - a. Frequency stall (230 percent causes acceleration stop, over 125 percent causes phase-back control).
 - b. Current limit, 140 percent.
 - c. Overcurrent, 180 percent IET.
 - d. Short circuit, phase-to-phase or phase to ground (trips fault).
 - e. Overvoltage: High DC bus voltage (trips fault)
 - 230V Series - 400 VDC
 - 460V Series - 800 VDC
 - 460V H Series - 760 VDC
 - f. Undervoltage, 85 percent below line voltage (indicates fault).
 - g. Component burnout, DC bus fuse protection and/or 3 phase input fusing.
 - h. Digital Indication of Fault: When the drive trips out on a fault, the drive shall activate a fault relay with normally open and normally closed contacts available to the user and an LED display shall indicate the reason for the trip as follows:

OC: Overcurrent trip at 180 percent.
OCA: Internal component short circuit.
OCL: Output short circuit.
OL: Overload (when soft stall not selected).
OP: Overvoltage on DC bus.
OPS: Overvoltage on input.
UP: Undervoltage.
OH: Overheat or closing of terminals OH.
EF: Ground fault (earth fault).

- i. Auto restart shall be a standard feature of the drive as follows:
 - 1) Auto restart enabled or disabled by jumper selection.
 - 2) If auto restart is selected the microprocessor shall determine, in the event of a fault, if a restart should be attempted. A restart shall be attempted under the following conditions:

Undervoltage (UP) - every time as soon as voltage returns to a safe level.
Fault relay is not activated (not jumper selectable).

Input Overvoltage (OPS) and DC Bus Overvoltage (OP) - every time if voltage returns to normal within 30 seconds, fault relay is not activated and reset for 30 seconds (jumper selectable).

Overcurrent (OC) - drive delays 1 second and attempts a restart. If drive trips a second time, it delays 2 seconds and attempts a second restart.
Overall, five attempts are made after successive delays of 1, 2, 4, 8 and 16 seconds. If the restart fails after the fifth attempt, the drive will trip out and activate the fault relay (jumper selectable).
 - 3) A restart shall not be attempted for any other type of fault and the drive shall trip out immediately, activate the fault relay and make the appropriate indication on the display.
- j. In the event of a fault trip the microprocessor shall save the status of the drive at the time of the fault and make that information available on the LED display until the drive is reset or the control power is removed.
- k. An undervoltage condition of less than 30ms duration shall not affect drive operation. If main power falls below 85 percent of rated voltage for longer than 30ms while control power is retained the drive shall forcibly decelerate the load in an attempt to force a higher bus voltage through regeneration. This feature, depending on the inertial of the load, shall allow the drive to "ride through" a longer condition.
- l. The following shall be mounted by drive manufacturer:
 - 1) Incoming motor circuit protector and thermal overload.
 - 2) AC Line Reactor: For reduction of harmonic content, power factor improvement and line transient suppression.
 - 3) Provide manual bypass switch which allows motor operation during service to variable speed drives.
 - 4) Integral disconnect switch.
- m. Operational Functions:
 - 1) Acceleration and deceleration time independently adjustable from 0.1 to 30/1 to 300 seconds (selectable ranges).

- 2) Signal follower 0 to 5VDC, 0 to 10VDC, 4 to 20ma, 0 to 20ma, 1 to 5VDC, or 0 to 135 ohms selectable by jumper. An increasing input signal can command increasing or decreasing frequency as required by the application.
 - 3) Ramp-to-stop or coast-to-stop for normal operation (coast-to-stop on fault).
 - 4) Volts/Hertz patterns selectable by rotary switch.
 - 5) Upper and lower frequency limit adjustments shall be available. When the drive reaches one of the limits it shall activate an open collector signal available to the user. A dry contact signal shall be available as an option.
- G. Equipment shall be provided with a terminal strip set up to have control input and output function interaction. Terminal strip shall have the connections to accept safety input, control signal input, run signal input, motor disconnect input, and fault signal output.

PART 3 - EXECUTION

3.1 INSTALLATION

- A. Install variable frequency drives in accordance with manufacturer's recommendations. Submit manufacturer's printed installation instructions with operating and maintenance data at completion of Work.
- B. Wiring of variable frequency drives shall be in accordance with Section 18 Specifications and supervised by an authorized factory representative. Drive shall be field commissioned by a factory trained and employed service technician.

****END OF SECTION****

SECTION 160100 HVAC PUMPS

PART 1 - GENERAL

1.1 WORK INCLUDED

- A. The Work of this Section shall consist of the labor, materials and equipment required for the installation of pumps and pump specialties.

1.2 RELATED SECTIONS

- A. Section 160020, HVAC Basic Materials: Equipment nameplates and motors
- B. Section 160070, HVAC Sound and Vibration Control: Vibration isolators and bases.
- C. Section 160090, Variable Frequency Drives: VFDs.
- D. Section 160210, Building Automation System: Controls.
- E. Section 160220, Testing and Balancing of HVAC System: Hydronic system balancing.

1.3 SUBMITTALS

- A. Submit for approval in accordance with specified submittal procedures:
 - 1. Pumps
 - 2. Pump Specialties

1.4 QUALITY ASSURANCE

- A. Source Limitations: Obtain hydronic pumps of same type from a single manufacturer.
- B. Electrical Components, Devices, and Accessories: Listed and labeled as defined in NFPA 70, Article 100, by a testing agency acceptable to authorities having jurisdiction, and marked for intended use.
- C. UL Compliance: Comply with UL 778 for motor-operated water pumps.

1.5 DELIVERY, STORAGE, AND HANDLING

- A. Manufacturer's Preparation for Shipping: Clean flanges and exposed machined metal surfaces and treat with anticorrosion compound after assembly and testing. Protect flanges, pipe openings, and nozzles with wooden flange covers or with screwed-in plugs.
- B. Store pumps in dry location.

- C. Retain protective covers for flanges and protective coatings during storage.
- D. Protect bearings and couplings against damage from sand, grit, and other foreign matter.
- E. Comply with pump manufacturer's written rigging instructions.

PART 2 - PRODUCTS

2.1 BASE MOUNTED PUMP

- A. Acceptable Manufacturer: Bell & Gossett, or Taco, Armstrong Pumps, Aurora Pump.
- B. Construction:
 - 1. Casing: Cast iron.
 - 2. Shaft: Steel.
 - 3. Shaft Sleeve: Bronze or copper, replaceable, covering the wetted area of the shaft under the seal.
 - 4. Impeller: Cast bronze, enclosed type, dynamically balanced, keyed to shaft and secured by a locking capscrew.
 - 5. Base: Structural steel or fabricated steel channel.
 - 6. Pump: Cast iron, single stage centrifugal end suction.
 - 7. Pump Seal: Standard, single mechanical seal with carbon seal ring and remite seat.
 - 8. Bearing Frame: Cast iron, fitted with regreasable ball bearings equivalent to electric motor bearing standards, for quiet operation.
 - 9. Motor: Refer to Section 160020, HVAC Basic Materials.
 - 10. Pump and motor mounted on common structural steel base.
 - 11. Pump internals capable of being serviced without disturbing piping connections or motor.
 - 12. Factory tested, cleaned and painted.
 - 13. Guard for couplings and rotating components.

2.2 INLINE PUMP

- A. Acceptable Manufacturer: Bell & Gossett, or Taco, Armstrong Pump.
- B. Type: Centrifugal, single stage.
- C. Materials
 - 1. Casing: Cast iron.
 - 2. Shaft: Steel.
 - 3. Shaft Sleeve: Brass or copper furnished under the wetted area of the mechanical seal.

4. Impeller: Brass or bronze enclosed type, hydraulically and dynamically balanced, keyed to shaft, and secured by a locking cap screw or nut.
5. Pump: Cast iron, bronze fitted, single stage centrifugal with vertical split case, rated for a minimum of 175 psi working pressure, equipped with gauge parts and suitable for operation at 225 degrees F.
6. Pump Seal: Mechanical seal with ceramic seal seat and carbon seal ring.
7. Bearing Frame: Cast iron, fitted with oil lubricated bronze bearings.
8. Motor: Refer to Section 160020, HVAC Basic Material.
9. Pump internals capable of being serviced without disturbing piping connections.
10. Factory tested, cleaned, and painted.

2.3 PUMP SPECIALTIES

A. Suction Diffuser

1. Acceptable Manufacturer: Bell & Gossett, or Taco, Armstrong.
2. Type: Angle type body with inlet vanes and combination diffuser-strainer-orifice cylinder.
3. Temporary Strainer: Disposable.
4. Permanent Strainer: With a free area no less than five times the suction area of the pump.
5. Support: Adjustable foot to support weight of unit and piping.
6. Cooling Tower Application: Diffuser shall have stainless steel orifice cylinder.

B. Triple Duty Valve

1. Acceptable Manufacturer: Bell & Gossett, or Armstrong Pump, Mueller Steam Specialty, Metraflex.
2. Working Pressure: 175 psig.
3. Maximum Operating Temperature: 300 degrees F.
4. Construction:
 - a. Body: Cast iron or ductile iron.
 - b. Disc and Seat: Bronze.
 - c. Stem and Spring: Stainless steel.
 - d. Packing: Teflon.
 - e. Flanges: Class 125 ANSI rated for 300 psi working pressure.
 - f. Configuration: Straight or angle pattern.
 - g. Valves: Globe valve and non-slam check valve with spring-loaded disc and calibrated adjustment to permit regulation of pump discharge flow and shut-off. Valves designed to permit repacking under full line pressure.
 - h. Brass readout valves equipped with integral EPT check valve for taking differential pressure reading across orifice.

PART 3 - EXECUTION

3.1 INSTALLATION

- A. Base mounted pumps shall be installed with suction diffuser, triple duty valves, isolation valves, and gages as detailed on the Drawings.
- B. Diagrammatic representation of inline pumps on the Drawings is only for clarification of pump location. Actual positioning of pump in the piping system, orientation of pump and motor, and location of supports for pumps shall be in accordance with pump manufacturer's recommendations.
- C. Base mounted pumps shall be provided with vibration isolation as specified in Section 160070, HVAC Sound and Vibration Control.
- D. Comply with inline pump manufacturer's installation instructions for supporting pump to maintain proper shaft alignment.
- E. All pumps and accessories shall be carefully inspected for defects in workmanship prior to installation. Any item found unsuitable, cracked, or otherwise defective shall be rejected and removed from the jobsite. All pumps shall have factory applied markings, stampings, or nameplates with sufficient data for identification to determine their conformance with specified requirements.
- F. During construction all openings in pumps shall be kept closed except when actual work is being performed on that item. Closures shall be plugs, caps, blind flanges, or other items specifically intended for this purpose. Exercise all necessary care to prevent foreign objects from entering equipment.
- G. Provide flanges or unions at all final connections to pumps to facilitate dismantling.

****END OF SECTION****

SECTION 160110 AIR DISTRIBUTION

PART 1 - GENERAL

1.1 WORK INCLUDED

- A. The Work of this Section shall consist of the labor, materials and equipment required for installation of the air distribution system ductwork, and associated specialties.

1.2 RELATED SECTIONS

- A. Section 160020, HVAC Basic Materials: Access doors.
- B. Section 160080, HVAC Insulation: Insulation of ductwork.

1.3 SUBMITTALS

- A. Submit for approval in accordance with specified submittal procedures:
 - 1. Single Wall Spiral Round Ductwork, including fittings
 - 2. Double Wall Spiral Round Insulated Ductwork, including fittings
 - 3. Flexible Ductwork
 - 4. Duct Accessories
 - 5. Diffusers, Registers, Grilles
 - 6. Fire Dampers
- B. Submit complete shop (fabrication) drawings of entire ductwork system. Ductwork shop drawings shall be drawn at a scale of no less than 1/4" equal 1 foot. Ductwork shop drawings shall be prepared by the ductwork fabricator, or his representative, and shall indicate coordination with all trades installing work in proximity of the ductwork indicated on the submittals.

PART 2 - PRODUCTS

2.1 RIGID METAL DUCTWORK

- A. Rigid metal ductwork and plenum chambers shall be fabricated from galvanized sheet steel constructed in accordance with SMACNA, HVAC Duct Construction Standards – Metal and Flexible based on indicated static-pressure class unless otherwise indicated. , and the latest publication of the ASHRAE Equipment Handbook.

1. Transverse Joints: Select joint types and fabricate according to SMACNA's "HVAC Duct Construction Standards - Metal and Flexible," Figure 1-4, "Transverse (Girth) Joints," for static-pressure class, applicable sealing requirements, materials involved, duct-support intervals, and other provisions in SMACNA's "HVAC Duct Construction Standards - Metal and Flexible."
 2. Longitudinal Seams: Select seam types and fabricate according to SMACNA's "HVAC Duct Construction Standards - Metal and Flexible," Figure 1-5, "Longitudinal Seams - Rectangular Ducts," for static-pressure class, applicable sealing requirements, materials involved, duct-support intervals, and other provisions in SMACNA's "HVAC Duct Construction Standards - Metal and Flexible."
 3. Elbows, Transitions, Offsets, Branch Connections, and Other Duct Construction: Select types and fabricate according to SMACNA's "HVAC Duct Construction Standards - Metal and Flexible," Chapter 2, "Fittings and Other Construction," for static-pressure class, applicable sealing requirements, materials involved, duct-support intervals, and other provisions in SMACNA's "HVAC Duct Construction Standards - Metal and Flexible."
- B. Changes in duct sizes shall be gradual with a slope of approximately 15 degrees divergence wherever possible; maximum 30 degrees divergence upstream of equipment and 45 degrees divergence downstream.
- C. Elbows shall be radius type made with an R/D ratio of 1.5. Square elbows with turning vanes shall be used where shown on Drawings or where space does not permit the foregoing radius.
- D. Range hood exhaust ductwork shall be fabricated in accordance with NFPA Standard 96.
- E. Dryer vent ductwork shall be fabricated from galvanized sheet metal in accordance with NFPA Standard 54.
- F. Un-insulated ductwork installed outdoors shall be fabricated from aluminum or stainless steel.
- G. Fume hood exhaust ductwork shall be fabricated from stainless steel only.
1. First quality, cold rolled annealed, pickled, ASTM A240 and A480, Finish No. 2B for concealed work and Finish No. 4 for exposed work. Unless otherwise indicated, use Type 304L where welded duct construction is specified and Type 304 where non-welded duct construction is allowed.
 2. Use stainless steel sheet with all joints and seams butt-welded airtight.
 3. Use longitudinal seam construction with seam at top on horizontal runs. Spiral seams are not allowed on round duct.
 4. Grind and polish smooth all interior joints.

2.2 SINGLE WALL SPIRAL ROUND METAL DUCTWORK, LOW PRESSURE

- A. Acceptable Manufacturer: McGill Airflow, or Semco Mfg., Inc.
- B. Low pressure/low velocity round metal ductwork shall be factory fabricated of galvanized steel meeting ASTM A 527 71. Ducts shall be fabricated with spiral lockseam construction. Fittings shall be galvanized steel, shall have a flanged saddle tap or slip joint and shall be produced by the same manufacturer. Metal gages for ducts shall be as follows:

<u>Duct Diameter</u>	<u>Duct Gage</u>
3" - 8"	26
9" - 22"	24
23" - 36"	22
37" - 50"	20

2.3 DOUBLE WALL SPIRAL ROUND INSULATED DUCTWORK

- A. Acceptable Manufacturer: McGill Airflow, or Semco Inc.
- B. Machine made from round spiral lockseam duct with light reinforcing corrugations, galvanized steel outer wall, 1 inch thick glass fiber insulation, solid perforated galvanized steel inner wall; fittings manufactured with perforated inner wall.

<u>Duct Diameter</u>	<u>Duct Gage</u>	<u>Fitting Gage</u>
3" - 14"	26	24
15" - 26"	24	22
28" - 36"	22	20
38" - 50"	20	20

2.4 FLEXIBLE DUCTWORK, ACOUSTIC

- A. Acceptable Manufacturer: Flexmaster Type 8M, Thermaflex M-KE, or as approved.
- B. Material: Acoustical round flexible ductwork consisting of helical wound corrugated steel with CPE inner film, exterior fiberglass insulation and reinforced metallized vapor barrier.
- C. Properties:
 - 1. Maximum K Factor: 0.20 at 75 degrees F.
 - 2. Temperature Range: Minus 10 degrees F to 250 degrees F
 - 3. Working Pressure: 10 inches w.g. positive, 5 inches w.g. negative thru 16 inches diameter.
 - 4. Listing: UL-181/ETL Class 1 Air Duct
 - 5. Compliances: NFPA 90A and 90B
 - 6. Flame Spread: Less than 25

7. Smoke Developed: Less than 50

D. Acoustical Performance Data: Minimum straight duct insertion loss in dB for 8 inch diameter, 9-10 feet long section at 2500 fpm velocity:

Octave Band Center Frequency, Hz					
<u>125</u>	<u>250</u>	<u>500</u>	<u>1000</u>	<u>2000</u>	<u>4000</u>
11	26	32	32	29	17

2.5 DUCT SEALANT

- A. Acceptable Manufacturer: Foster, or Duro Dyne.
- B. Duct joints and seams shall be sealed to minimize air leakage.

2.6 DUCT SEALANT, HIGH VELOCITY

- A. Acceptable Manufacturer: United McGill tape and sealer.
- B. High velocity duct joints and seams shall be sealed with tape as specified herein. Liquid duct sealer shall be applied to male end only of slip type fittings prior to assembly. Single slip fittings shall be secured with sheet metal screws following application of liquid sealer and assembly of joint. Apply liquid sealer to outside of assembled joint in a 2 inch wide band. Wrap a single thickness of polyethylene coated duct tape over wet sealer and allow to set for 24 hours. Flanged joints shall be sealed with either a self-adhering neoprene rubber gasket or impregnated felt gasket adhered to flanged joint with duct sealer.

2.7 VOLUME DAMPERS

- A. Acceptable Manufacturer: Young Regulator Co. for dampers with smallest dimension 10 inch or less, Louvers & Dampers, Inc. for dampers with smallest dimension 12 inch or more.
- B. Each damper shall be equipped with adjustable quadrant regulator and lock. Dampers shall be multiple blade. Single blade damper units will not be permitted. Maximum blade width shall be 10 inch and maximum blade length shall be 42 inch. Longer spans shall consist of multiple damper sections.
- C. On externally-insulated ducts, mount quadrant regulators on stand-off brackets to accommodate thickness of insulation.

2.8 TURNING VANES

- A. Turning vanes shall be provided in all square elbows unless specifically noted otherwise. Turning vanes shall be single thickness vane style, with **no** trailing (flat) edges. Vanes shall be securely fastened to runners. Runners shall be securely fastened to ductwork. For lined ductwork, runners shall be raised hat style to prevent damage to duct liner. Turning vanes greater than 36 inch in length shall be braced at intermediate points with tie rods.

- B. All turning vanes shall be fabricated and installed in accordance with SMACNA HVAC Duct Construction Standards.

2.9 FLEXIBLE DUCT CONNECTORS

- A. Acceptable Manufacturer: Duro Dyne, or Elgen, Ventfabrics.
- B. Connector: 24 or 28 gage galvanized steel.
- C. Fabric: Woven fiberglass, coated with neoprene. Water proof and airtight. Designed to meet NFPA 701, 90A and 90B.

2.10 TAKE OFF FITTINGS

- A. Acceptable Manufacturer: Clevepak Corp., Flexmaster.
- B. Take off connections for use in connecting flexible ductwork to rectangular duct systems shall be straight tap-in type, prefabricated, galvanized steel construction, with damper. Take off connections shall be same size as flexible duct.

2.11 DUCT ACCESS DOORS

- A. Acceptable Manufacturer: Cesco Advanced Air.
- B. Application: Install in ductwork within working distance of all duct coils, fire dampers, motor-operated dampers and volume dampers to permit inspections and adjustments.
- C. Construction: Reinforced with angle iron stiffeners and provided with a continuous edge gasket for airtight fit. Insulated where installed in insulated duct systems.
- D. Closure Method: Double cam latch.

2.12 SIDEWALL AND CEILING REGISTERS AND GRILLES, EXHAUST, RETURN

- A. Acceptable Manufacturer: Titus Model 350 ZFL, or Tuttle & Bailey, Anemostat, Carnes, Krueger, Metalaire, Price Industries.
- B. Construction: Extruded aluminum.
- C. Standard Features:
 - 1. 1 inch minimum frame with mitered corners.
 - 2. Fixed position horizontal bars at 0 degree deflection and spaced 3/4 inches on center.
- D. Accessories: Opposed blade damper (register only).
- E. Finish: Baked white enamel.

2.13 SIDEWALL REGISTERS AND GRILLES, SUPPLY

- A. Acceptable Manufacturer: Titus Model 300FL, or Tuttle & Bailey, Anemostat, Carnes, Krueger, Metalaire, Price Industries.
- B. Construction: Extruded aluminum.
- C. Standard Features:
 - 1. 1 inch minimum frame with mitered corner.
 - 2. Double deflection air foil shaped bars with adjustable horizontal front bars spaced 3/4 inch on center, providing greater than 80 percent free area.
- D. Accessories: Opposed blade damper (register only).
- E. Finish: Baked white enamel.

2.14 SIDEWALL DIRECT SPIRAL GRILLES, RETURN

- A. Acceptable Manufacturer: Titus Model S8F, or Tuttle & Bailey, Anemostat, Krueger, Metalaire, Carnes.
- B. Construction: Extruded aluminum.
- C. Standard Features:
 - 1. 1 inch minimum frame.
 - 2. Perforated face.
 - 3. Grilles shall be constructed with radiused endcaps and foam gaskets for a tight seal.
- D. Finish: As selected by Architect.

2.15 SIDEWALL DIRECT SPIRAL REGISTERS, SUPPLY

- A. Acceptable Manufacturer: Titus Model S300FL, or Tuttle & Bailey, Anemostat, Krueger, Metalaire, Carnes.
- B. Construction: Extruded aluminum.
- C. Standard Features:
 - 1. 1 inch minimum frame.
 - 2. Double deflection air foil shaped bars with adjustable horizontal front bars.
 - 3. Grilles shall be constructed with radiused endcaps and foam gaskets for a tight seal.
- D. Accessories: Air scoop/extractor damper (register only).
- E. Finish: As selected by Owner.

2.16 CEILING DIFFUSERS, HIGH PERFORMANCE

- A. Acceptable Manufacturer: Titus TMS-AA, or Anemostat, Krueger, Price Industries, Tuttle & Bailey.
- B. Construction: Extruded aluminum.
- C. Standard Features:
 - 1. 360 degree air pattern.
 - 2. 24 x 24 full face and panel mounted lay in type frames.
 - 3. Flush cones.
 - 4. Removable inner core.
- D. Accessories:
 - 1. Adjustable volume damper.
 - 2. Sectorizing baffle.
- E. Finish: Baked white enamel.

2.17 FIRE DAMPER, PRIMARY

- A. Acceptable Manufacturer: Ruskin, or Cesco Products, Prefco Products.
- B. Type: Multiple interlocking steel "curtain" damper.
- C. Construction: Galvanized steel frame and blades; blades stacking out of air stream; for rectangular damper with smallest dimension 12 inches or less, frame and blades shall be out of air stream. Damper shall be suitable for vertical or horizontal mounting; labeled as a dynamic rated 1 1/2 hour fire damper; constructed in accordance with UL 555.
- D. Fusible Link: UL listed 165 degrees F.
- E. Wall Sleeve: Contractor's option for manufacturer's accessory wall sleeve or contractor fabricated, in accordance with SMACNA Duct Construction Standards.
- F. Compliance: NFPA 90A.

PART 3 - EXECUTION

3.1 INSTALLATION

- A. Rigid metal ductwork and associated specialties shall be installed in accordance with SMACNA, HVAC Duct Construction Standards, and the latest publication of the ASHRAE Equipment Handbook. Rigid and flexible ductwork shall be installed in sizes indicated with field supplied rigid metal transitions at connections to equipment duct collars.

- B. Protect open ends of ductwork during construction, either stored or installed, with plastic covering.
- C. Flexible duct connectors shall be installed on inlet and outlet of each fan and air handling unit.
- D. Fire dampers shall be installed in accordance with the International Building Code, SMACNA Fire, Smoke and Radiation Damper Installation Guide for HVAC Systems, and manufacturer's installation requirements. The UL label shall be visible for inspection from a duct access door which is labeled to identify the damper type.
- E. Rectangular sheet metal ductwork shall be insulated internally. Duct dimensions shown on Drawings are net clear inside dimensions, that is, the inside dimensions of the duct insulation. Refer to Section 160080, HVAC Insulation.
- F. Range hood exhaust ductwork shall be installed in accordance with NFPA 96.
- G. Flexible nonmetallic ductwork shall be connected to rigid metal duct fittings and terminal unit duct collars by draw straps. Extend flexible duct insulation and vapor barrier over completed joint and tape securely.
- H. Manual volume dampers shall be installed in all branch ducts for balancing and as indicated on Drawings.
- I. Access panels shall be installed in inaccessible ceilings for access to air distribution devices requiring adjustment, repair, or replacement. Refer to Section 160020, HVAC Basic Materials.
- J. Installation of Exposed Ductwork
 - 1. Protect ducts exposed in finished spaces from being dented, scratched, or damaged.
 - 2. Trim duct sealants flush with metal. Create a smooth and uniform exposed bead. Do not use two-part tape sealing system.
 - 3. Grind welds to provide smooth surface free of burrs, sharp edges, and weld splatter. When welding stainless steel with a No. 3 or 4 finish, grind the welds flush, polish the exposed welds, and treat the welds to remove discoloration caused by welding.
 - 4. Maintain consistency, symmetry, and uniformity in the arrangement and fabrication of fittings, hangers and supports, duct accessories, and air outlets.
 - 5. Repair or replace damaged sections and finished work that does not comply with these requirements.

3.2 DUCT SEALING

- A. Seal ducts for duct static-pressure, seal classes, and leakage classes specified in "Duct Schedule" Article according to SMACNA's "HVAC Duct Construction Standards - Metal and Flexible."

3.3 HANGER AND SUPPORT INSTALLATION

- A. Comply with SMACNA's "HVAC Duct Construction Standards - Metal and Flexible," Chapter 4, "Hangers and Supports."

3.4 DUCT LEAKAGE TESTING

- A. Perform duct leakage testing in accordance with SMACNA "HVAC Air Duct Leakage Test Manual" and submit written letter of compliance.
1. Disassemble, reassemble and seal segments of systems as required to accommodate testing.
 2. Conduct tests at static pressures equal to maximum design pressure of system. Do not pressurize systems above maximum design operating pressure.
 3. Maximum allowable leakage shall be SMACNA Leakage Class 3 for supply air ducts and Leakage Class 6 for return air ducts.
 4. Leaking joints shall be remade and retested until leakage is equal to or less than the maximum allowable.

3.5 DUCT CONSTRUCTION SCHEDULE

Air System	Pressure Class	SMACNA Seal Class
Supply Ducts Connected to Central Station Variable Air Volume Air Handling Units	Positive 3 inches w.g.	B
Supply Ducts Connected to Central Station Constant Volume Air Handling Units	Positive 2 inches w.g.	C
Supply Ducts Connected to Unitary Equipment (heat pumps, fan coil units, split systems, etc.)	Positive 1 inch w.g.	C
Supply Ducts Downstream of Variable Air Volume Boxes	Positive 1 inch w.g.	C
Return and Relief Air Ducts Connected to Central Station Air Handling Units and	Negative 2 inches w.g.	C
Return Ducts Connected to Unitary Equipment (heat pumps, fan coil units, split systems, etc.)	Negative 1 inch w.g.	C
Outside Air Ducts Connected to Central Station Air Handling Units	Negative 2 inches w.g.	C

Air System	Pressure Class	SMACNA Seal Class
Outside Air Ducts Connected to Unitary Equipment (heat pumps, fan coil units, split systems, etc.)	Negative 1 inch w.g.	C
General Exhaust Ducts	Positive or Negative 1 inch w.g.	C
Special Exhaust Ducts: slot hoods, fume hoods, flexible arms and spray booth	Positive or Negative 2 inches w.g.	C

END OF SECTION

**SECTION 160120
VARIABLE AIR VOLUME SYSTEMS**

PART 1 - GENERAL

1.1 WORK INCLUDED

- A. The Work of this Section shall consist of the labor, materials and equipment required for installation of variable air volume equipment.
- B. For product description, refer to Section 160210, Building Automation System.

PART 2 - PRODUCTS

(NOT USED)

PART 3 - EXECUTION

3.1 INSTALLATION

- A. Install VAV equipment in accordance with equipment manufacturer's recommendations. Submit manufacturer's printed installation instructions with operating and maintenance data at completion of Work.
- B. Provide supporting steel for support of VAV equipment from substantial building structure. Do not support VAV equipment from adjacent equipment, piping, or ductwork.
- C. Provide sheet metal transitions as required for inlet and discharge connections of VAV equipment.

****END OF SECTION****

**SECTION 160130
FANS AND GRAVITY VENTILATORS**

PART 1 - GENERAL

1.1 WORK INCLUDED

- A. The Work of this Section shall consist of the labor, materials and equipment required for installation of fans and gravity ventilators.

1.2 RELATED SECTIONS

- A. Section 160020, HVAC Basic Materials: Motors
- B. Section 160070, HVAC Sound and Vibration Control: Vibration isolators and bases.

1.3 SUBMITTALS

- A. Submit for approval in accordance with specified submittal procedures:
 - 1. Fans
- B. Product Data: Submit manufacturer's technical product data for fans, including:
 - 1. Selection characteristics and rated capacities.
 - 2. Fan performance curves with system operating conditions indicated.
 - 3. Sound power ratings, with an 8 octave band analysis for large, central system fans.
 - 4. General specifications: Fan type description, material of construction, thicknesses and finishes.
 - 5. Motor type, ratings and electrical characteristics
 - 6. Accessories furnished
- C. Shop Drawings: Include the following:
 - 1. Plans, elevations, sections, and attachment details.
 - 2. Details of equipment assemblies. Indicate dimensions, weights, loads, required clearances, method of field assembly, components, and location and size of each field connection.
 - 3. Vibration Isolation Base Details: Detail fabrication, including anchorages and attachments to structure and to supported equipment. Include auxiliary motor slides and rails, and base weights.
- D. Wiring Diagrams: Submit manufacturer's electrical requirements for power supply wiring to fan units. Submit manufacturer's ladder-type wiring diagrams for interlock and control wiring. Clearly differentiate between portions of wiring that are factory-installed and portions to be field-installed.

- E. Coordination Drawings: As required to meet project complexity, show fan room layout and relationships between components and adjacent structural and mechanical elements. Show support locations, type of support, and weight on each support. Indicate and certify field measurements.
- F. Maintenance Data: Submit operation and maintenance instructions, including lubrication instructions, motor and drive replacement, and spare parts lists. Include this data, product data, shop drawings, and wiring diagrams in maintenance manuals.
- G. Field quality-control reports.
- H. Manufacturer's published fan curve data shall be included with shop drawing submittal data for fans. Fan curve information shall include operating point, RPM curve for operating point, minimum and maximum RPM curves for fan, system curve and brake horsepower curves. Tabular fan performance charts are not an acceptable substitute for fan curve data. Shop drawing submittals for air handling equipment will be returned without Architect's review if the fan curve data is not included with the submittal.

1.4 QUALITY ASSURANCE

- A. Electrical Components, Devices, and Accessories: Listed and labeled as defined in NFPA 70, by a qualified testing agency, and marked for intended location and application.
- B. Fan rating shall be AMCA certified.

1.5 SOURCE QUALITY CONTROL

- A. Fan Sound-Power Level Ratings: Comply with AMCA 301, "Methods for Calculating Fan Sound Ratings from Laboratory Test Data." Test fans according to AMCA 300, "Reverberant Room Method for Sound Testing of Fans." Fans shall bear AMCA-certified sound ratings seal.
- B. Fan Performance Rating: Factory test fan performance for airflow, pressure, power, air density, rotation speed, and efficiency. Rate performance according to AMCA 210, "Laboratory Methods of Testing Fans for Aerodynamic Performance Rating."

1.6 EXTRA MATERIALS

- A. Furnish one set of extra fan belt(s) for each fan. Identify unit designation on packaging sleeves.

PART 2 - PRODUCTS

2.1 GENERAL

- A. Fan ratings shall be AMCA certified and statically and dynamically balanced and run tested at the factory.

- B. Bearings: Fans, except power roof ventilators, shall be provided with lubricating type bearings with extended fittings as required. Extend grease fittings to safe, accessible locations.
- C. Motors: Refer to Section 160020 for motor requirements.
- D. Accessories:
 - 1. Belt guards: Where required, guards shall be fabricated to comply with OSHA and SMACNA requirements, constructed of expanded metal mesh to allow for quick visual inspection of belts and pulleys without removal. Guards shall be attached to equipment with hinges and/or quick release fasteners that can be turned without tools to allow for ease of maintenance. Secure to fan or fan supports without short circuiting vibration isolation.
 - 2. Access for Inspection, Cleaning, and Maintenance: Comply with requirements in ASHRAE 62.1.
 - 3. Scroll Drain Connection: NPS 1 steel pipe coupling welded to low point of fan scroll.
 - 4. Roof Exhaust Fan Roof Curbs: Provide manufacturers roof curb with outer finish to match fan. Provide hinging kit to allow easy access to damper. Curb shall be insulated with 2 inch thick sound and thermal insulation.

2.2 CABINET FAN, TYPE CFD

- A. Acceptable Manufacturer: Greenheck Fan Corp., or Loren Cook Company, Broan, Carnes, PennBarry, Solar & Palau.
- B. Blower: Centrifugal, aluminum.
- C. Housing
 - 1. Insulated steel with discharge duct collar.
 - 2. Integral backdraft damper.
 - 3. Integral terminal box.
 - 4. Removable fan motor and wheel assembly from housing.
- D. Ceiling Grille: Fan shall be furnished with either a molded plastic or aluminum egg crate ceiling grille.
- E. Accessories
 - 1. Electronic speed controller. Integral electric disconnect, powered off, switch.

2.3 CENTRIFUGAL UPBLAST ROOF FAN, TYPE UFCB

- A. Acceptable Manufacturer: Greenheck Fan Corp., or Loren Cook Company, PennBarry, Carnes, Solar & Palau.
- B. Housing
 - 1. Heavy gage spun aluminum.

2. Rain and grease collection/drainage area at base of housing.

C. Motor

1. Vibration isolated.
2. Permanently lubricated ball bearing type enclosed in forced air cooled motor compartment sealed from exhaust air stream.
3. Prewired to integral UL listed disconnect switch within fan housing.
4. Adjustable motor pulley.

D. Fan Wheel

1. Vibration isolated.
2. Centrifugal, statically and dynamically balanced.

E. Accessories

1. Bird screen.
2. Variable pitch motor pulley.
3. Automatic spring loaded belt tightener.
4. Insulated roof curb, 12 inches high minimum.
5. Vented curb extension, where required.
6. Grease trap for fans serving Type I kitchen hoods.

2.4 CENTRIFUGAL HIGH PLUME EXHAUST FAN, TYPE FHCB

A. Acceptable Manufacturer: Greenheck Fan Corp Vektor H, or approved equal.

B. General:

1. Fasteners exposed to exhaust stream shall be stainless steel.
2. Fan assembly shall be designed for a minimum of 125 MPH wind loading, without the use of guy wires.

C. All fan system components shall be corrosion resistant coated with a two part electrostatically applied and baked, corrosion resistant coating system.

D. Performance: Fans shall be tested in accordance with AMCA test codes for air moving devices and shall be guaranteed by the manufacturer to deliver rated published performance levels.

E. Housing: Housings shall be cylindrical and welded steel throughout. Inlets shall be fully streamlined. Housings shall be suitably braced to prevent vibration or pulsation. Totally enclosed weather cover shall enclose motor and V-belt drives. Punched inlet flange shall be equipped for curb cap or mixing plenum box mounting. Extended lube lines shall be provided for ease of lubrication. Include high velocity conical discharge nozzle, heavy duty coated steel curb cap, access door, shaft seal and weather cover, and a sealed belt tube for the protection of belts and drive components from the airstream.

- F. Wheel: Aluminum fan wheels shall have die-formed blades designed for maximum efficiency, and quiet and stable operation. Blades shall be continuously welded to the back plate and wheel cone. Wheels shall be statically and dynamically balanced and the complete fan assembly including motor and drive shall be test balanced at or near the operating speed at the factory prior to shipment.
- G. Shaft: Shafts shall be AISI 1040 or 1045 hot rolled steel, accurately turned, ground, polished, and ring gauged for accuracy. Shafts shall be sized for the first critical speed of at least 1.43 times the maximum speed.
- H. Bearings: Bearings shall be heavy duty, grease lubricated, anti-friction ball or roller, self-aligning, pillow block type and selected for a minimum L-10 life of 200,000 hours at the maximum fan RPM. Bearings shall be equipped with extended lubrication lines with grease fittings outside of the fan housing.
- I. Drive: Drives shall be sized for at least 200% of motor horsepower.
- J. Weather Cover: A raintight, removable weather cover shall be provided to completely enclose the motor and exposed parts of the V-belt drive.
- K. Accessories:
 - 1. Disconnect switch
 - 2. Roof curb

PART 3 - EXECUTION

3.1 INSTALLATION

- A. Install fans in accordance with equipment manufacturer's recommendations. Submit manufacturer's printed installation instructions with operating and maintenance data at completion of Work.
- B. Install fans level and plumb to prohibit excessive vibration and insure longer life.
- C. Protect belts, sheaves, bearings, motors and other fan parts during installation.
- D. Access: Provide adequate access and service clearance space around and over fans as indicated, but in no case less than that recommended by manufacturer. Allow adequate and safe pathway for components and unit replacement.
- E. Isolation: Comply with requirements for vibration isolation devices specified in Section 160070, HVAC Sound and Vibration Control.
- F. Duct Connections:
 - 1. Minimize Fan System Effects: Avoid poor fan inlet and outlet conditions. Comply with manufacturer's installation guidelines.
 - 2. Make final duct connections with flexible connectors.

3. Install ducts adjacent to fans to allow service and maintenance.
 4. Provide access door in duct below power roof ventilators to service damper.
- G. Secure roof-mounted fans to roof curbs with cadmium-plated hardware.
- H. Electrical Connections: Ground equipment and connect control wiring according to Section 18.
- I. Roof curbs provided as Work of this Section shall be coordinated with requirements of the roofing subcontractor. Shop drawing submittals for roof curbs, with, or without, cants will be considered in compliance with roofer's requirements.

3.2 FIELD QUALITY CONTROL

- A. Upon completion of installation of fans, and after motor has been energized with normal power source, perform the following tests and inspections with the assistance of a factory-authorized service representative to demonstrate compliance with requirements:
1. Verify that shipping, blocking, and bracing are removed.
 2. Verify that unit is secure on mountings and supporting devices and that connections to ducts and electrical components are complete. Verify that proper thermal-overload protection is installed in motors, starters, and disconnect switches.
 3. Verify that cleaning and adjusting are complete.
 4. Disconnect fan drive from motor, verify proper motor rotation direction, and verify fan wheel free rotation and smooth bearing operation. Reconnect fan drive system, make final alignments of pulleys and belt tension, and install belt guards.
 5. Adjust damper linkages for proper damper operation.
 6. Verify lubrication for bearings and other moving parts.
 7. Verify that manual and automatic volume control and fire in connected ductwork systems are in fully open position.
 8. Test and adjust controls and safeties. Controls and equipment will be considered defective if they do not pass tests and inspections.
 9. Prepare test and inspection reports.
- B. Remove and replace malfunctioning units that cannot be satisfactorily corrected and retest as specified above.

****END OF SECTION****

**SECTION 160140
DUST COLLECTION SYSTEM**

PART 1 - GENERAL

1.1 WORK INCLUDED

- A. The Work of this Section shall consist of the labor, materials and equipment required for installation of the dust collection systems.

1.2 SUBMITTALS

- A. Submit for approval in accordance with specified submittal procedures:
 - 1. Weld Smoke Collectors

PART 2 - PRODUCTS

2.1 WELDING SMOKE COLLECTOR EXHAUST SYSTEM

- A. Acceptable Manufacturer: Airflow Systems Model F122 Industrial Media Air Clear with dual arms or as approved.
- B. Welding booth exhaust system shall be 2 stage, self-contained, re-circulating source capture unit to remove contaminants of smoke and dust. Filters shall meet or exceed ASHRAE standard 52-76 test methods. Units shall be self-supporting for ceiling mounting. Provide 3/8 inch eyebolts to be factory installed for hanging of unit. Cabinet shall be 16 gage, welded zinc coated steel with 2 part chemical and oil resistant coating and hinged access side door and intake plenum with external self-supported source capture arm assemblies.
- C. Blower assembly shall be Class II backward inclined type with direct drive motor.
- D. Unit shall be provided with 2 stages of filtration. Stage 1 filtration shall be 2 inch metal mesh. Stage 2 filtration shall be a multi-pocket 64 square feet of filter area, 95 % efficient main filter. Main filter to include ultra-seal filter mounting frame to eliminate bypass air around high efficiency main filter.
- E. 0 to 10 inch W.C. dial pressure gage, factory installed.
- F. Discharge silencer with 4-way outlet damper.
- G. Two 7 inch x 10 feet long source capture arm assemblies shall be provided with unit. Each arm assembly shall include the following;
 - 1. Arm assembly shall be constructed with external support at the shoulder and elbow joints and internal support at the wrist joint.

2. Shoulder joint shall include a spring balanced base, elbow joint to include friction release system, and wrist joint to include universal joint.
 3. UL fire retardant spiral flex hose shall be furnished at shoulder, elbow and wrist joints only
 4. Aluminum tubing with black powder paint finish to be provided between flex hoses. A flanged hood with same finish and adjustable airflow damper shall also be included.
 5. Each arm assembly to also include a 75 watt, 12 volt light kit assembly with transformer. Light to turn on when unit is energized.
- H. Provide spare filters, two (2) sets of main filters in addition to filter in unit at start-up.

PART 3 - EXECUTION

3.1 INSTALLATION

- A. Install dust collection system in accordance with equipment manufacturer's recommendations. Submit manufacturer's printed installation instructions with operating and maintenance data at completion of Work.
- B. Filters installed in equipment during the construction period will be considered temporary.

3.2 FIELD QUALITY CONTROL

- A. Perform the following field tests and inspections and prepare test reports:
 1. Operational Test: After electrical circuitry has been energized, start units to confirm proper motor rotation and unit operation.
 2. Test and adjust controls and safeties. Replace damaged and malfunctioning controls and equipment.
- B. Remove and replace malfunctioning units and retest as specified above.

****END OF SECTION****

**SECTION 160150
KITCHEN/FUME HOODS**

PART 1 - GENERAL

1.1 WORK INCLUDED

- A. The Work of this Section shall consist of the labor, materials and equipment required for installation of factory fabricated kitchen/fume hoods.

1.2 SUBMITTALS

- A. Submit for approval in accordance with specified submittal procedures:
 - 1. Range Hood
 - 2. Fume Hood
 - 3. Spray Booth

PART 2 - PRODUCTS

2.1 RANGE HOOD

- A. Acceptable Manufacturer: Greenheck GHEW, or Captive-Aire, Gaylord.
- B. Type: Type 1, prepackaged hood with built-in grease extraction and automatic fire protection. Hood shall be wall mounted, canopy style, exhaust only.
- C. Materials: 18 gage stainless steel.
- D. Construction: All seams and joints shall be welded. Welds shall be cleaned, deburred and polished. Provided with factory mounted exhaust collar. Hoods shall be listed and labeled according to UL 710.
- E. Filters shall be baffle type, stainless steel, UL classified. The filter housing shall terminate in a grease trough, full length of hood.
- F. Lights shall be recessed fluorescent lamps with a vapor proof fixture. Lights shall be pre-wired to hood control panel.
- G. Fire Protection: Hood manufacturer shall furnish and install surface fire protection system. System shall be fully automatic wet chemical type, based on Ansul R-102. System components shall include fan interlock, agent storage cylinders, remote manual pull station, controls, piping and heads below hood. Fire-suppression cabinet shall be mounted to hood.
- H. Installation shall be in accordance with International Mechanical Code Chapter 507, UL and Pennsylvania Department of Labor and Industry.

- I. Testing: UL.
- J. Accessories:
 - 1. Provide heat sensor to activate exhaust fan when heat below hood is sensed.
 - 2. Provide manufacturer's accessory fan control cabinet:
 - a. Lights: On-off switch for control of hood lights.
 - b. Exhaust Fan: On-off switch and motor starter (with thermal overloads) for control of exhaust fan. Interlock exhaust fan with fire-suppression system to operate fan during fire-suppression agent release and to remain in operation until manually stopped. Include red pilot light to indicate fan operation.
 - c. Interlock with fire alarm system to annunciate at fire alarm control panel when fire protection is activated.
 - d. Switch to shutdown electric range upon activation of fire-suppression system.
 - e. Temperature interlock to start fan upon sensing of cooking heat.

2.2 FUME HOOD

- A. Acceptable Manufacturer: Kewaunee Scientific Corporation Model H05, or as approved.
- B. Type: Hood shall be of the bypass type. The fume hood design shall allow for automatic air bypass above the sash opening. The bypass shall limit the maximum air velocity through the face of the hood and provide for a constant volume of air through the hood regardless of sash position. The bypass shall control the increase in face velocity as the sash is lowered to limit the maximum velocity to not more than three and one-half, times the velocity with the sash full open.
- C. Fume Hood Superstructure Frame: A free-standing rigid frame structure of steel angle shall be provided to support exterior panels and interior liner and baffle panels. To allow for maintenance and replacements, the interior liner panels shall be removable without disassembly of the frame structure and outer steel panels. Likewise, the exterior steel panels shall be removable without disassembly of the frame structure and inner liner panels. Fume hoods that require disassembly of the superstructure for liner replacement will not be acceptable.
- D. Fume Hood Interior Walls: Double wall ends, not more than 4 inches wide, shall be provided to maximize interior working area. The area between the double wall ends shall be closed to house the remote control valves. The front vertical fascia section shall have a full 135 degree, 1 inch radius at the front leading edge to provide a streamlined section and insure smooth even flow of air into the hood. The vertical facias shall contain the required service controls, electrical switches and receptacles. The hood interior end panels and sash track shall be flush with the fascia to prevent eddy currents and back flow of air.
- E. Fume Hood Airfoil: A streamlined airfoil shall be integral at the bottom of the hood opening on bench and distillation hoods. This foil shall provide a nominal 1 inch open space between the foil and the top front edge of the work surface to direct an air stream across the work surface to prevent back flow of air. The airfoil shall extend back under the sash, so that the sash does not close the 1 inch opening. The foil shall be removable to allow large equipment into the hood. The foil shall be of 12-gage steel to resist denting and flexing. Walk-in hoods shall have a stop located at the bottom of the sash track that will ensure a nominal 1 inch opening between the bottom of the sash and the floor.

- F. Fume Hood Top Panel: The top front panel shall be of the same material as the exterior facia. It shall contain a chevron shaped grille that is sight-tight to create an effective barrier against flying debris from inside the hood. The top front panel of the hood shall have an integral vision panel. It shall be located directly above the sash opening and in such a manner that it allows viewing into the top portion of the hood without the operator having to stoop or place their face inside the hood.
- G. Fume Hood Baffles: A single-point baffle adjustment shall allow the operator to make adjustments without placing their hand further than six inches into the hood.
- H. Fume Hood Duct Collar: A 12 inch diameter stainless steel bell-mouthed duct collar shall be located in the top of the hood plenum chamber.
- I. Fume Hood Lighting: A one-tube, energy-efficient, T-5 fluorescent light fixture of the size given below shall be provided in the hood roof. Illumination at 13 inches above the work surface shall be at least 100 foot-candles.

<u>Hood Size, Ft.</u>	<u>Nominal Fixture Length, Ft.</u>
4	3
5	4
6	4
8	3 (2 Fixtures)

The light fixtures shall be isolated from the hood interior by a 1/4 inch thick tempered glass panel sealed from the hood cavity. Fixture shall be UL labeled.

- J. Fume Hood Sash: Vertical rising sash with 1/4 inch laminated safety float glass shall be provided. The sash shall have a neutral colored polyvinyl chloride horizontal member at the top and a full length metal handle at the bottom. The sash shall be counterbalanced with a single weight to prevent tilting and binding during operation. The sash track shall be a neutral colored polyvinyl chloride set flush with the interior liner panels to minimize turbulence. Bench hoods shall have one sash in a single slotted sash track. Walk-in hoods shall have two sashes in a double slotted sash track.
- K. Fume Hood Plumbing Services: Plumbing services shall consist of remote control valves as selected located within the end panels, controlled by extension rods projecting through the control panels of the hood, with color coded plastic handles. Interior fitting for gases and water shall be nylon panel flanges and angle serrated hose connectors, color coded. Interior fittings for distilled water shall consist of a bronze tin lined, white color-coded, panel flange and angle serrated hose connector. Interior fittings for steam shall consist of a cast bronze flange and angle serrated hose connector with a chemical resistant metallic bronze finish. Water goosenecks shall be cast bronze with a chemical resistant metallic bronze finish. All plumbing fittings shall be factory installed and piped between the valve and the outlet. Inlet piping shall have a single-point connection for each valve provided and carried to a point 1 inch above the fume hood roof or 1 inch above the worktop rear corner depending on the rough-in locations shown in the drawings. Points of final service connection by other trades shall be at the stub provided by the fume hood manufacturer.
- L. Fume Hood Electrical Services: The hood superstructure shall be pre-wired and contain a UL label certifying acceptable wire gauge, connections, fixtures and wire color coding. Wiring electrical services shall consist of two duplex receptacles and a light switch. The duplex

receptacles shall be 20 amp, 120 volt AC, and 3-wire polarized grounded with ground fault interruption. The receptacles shall be of specification grade, side wired only, to insure a positive connection. The light switch shall be 20 amp, 125 volt AC, and 3-wire polarized grounded. Wiring shall terminate in one 6 inches x 6 inches x 4 inches service junction box located on the fume hood roof. Final wiring and circuit dedication shall be by others. A single pole 120 volt, 20 amp toggle switch shall be provided for control of a remote exhaust fan.

- M. Work Surface: Hood work surface shall be 1-1/4 inch thick molded epoxy resin made in the form of a watertight pan, not less than 3/8 inch deep to contain spillage with a 6 inches wide safety ledge across the front edge. Top shall be manufactured at the same manufacturing location as the fume hood to assure proper cutout alignment and coordinated shipping. A cup drain flush with the recessed work surface shall be provided. The work surface and cup drain shall be available in either black or grey.
- N. Access Opening: The interior end liner panels shall be furnished with an opening that provides access to the service piping and valves to facilitate installation and maintenance. The openings shall be covered with a removable panel with rounded corners. Panels that require tools to remove will not be acceptable. The panel shall provide an overlapping seal on all edges.
- O. Finish: After the component parts have been completely welded together and before finishing, they shall be given a pre-paint treatment to provide excellent adhesion of the finish system to the steel and to aid in the prevention of corrosion. Physical and chemical cleaning of the steel shall be accomplished by washing with an alkaline cleaner, followed by a spray treatment with a complex metallic phosphate solution to provide a uniform fine grained crystalline phosphate surface that shall provide both an excellent bond for the finish and enhance the protection provided by the finish against humidity and corrosive chemicals. After the phosphate treatment, the steel shall be dried and all steel surfaces shall be coated with a chemical and corrosion-resistant, environmentally friendly, electrostatically applied powder coat finish. All components shall be individually painted, insuring that no area be vulnerable to corrosion due to lack of paint coverage. The coating shall then be cured by baking at elevated temperatures to provide maximum properties of corrosion and wear resistance.
- P. Fume Hood Dimensions: Double wall end panel thickness shall not exceed 4 inches. Interior clear working height shall be not less than 41-3/4 inches at any location in the interior of the hood on bench hoods and 76 inches on walk-in and distillation hoods. Interior depth from the back of the sash to the front of the rear baffle shall not be less than 25-1/4 inches. The sash opening shall be not less than 28 inches in height above the work surface on bench hoods and 60 inches on walk-in and distillation hoods.
- Q. Fume Hood Liner: Epoxy resin liner shall be the manufacturing standard for liners in this specification. To assure proper punching and coordination with remaining pieces of assembled fume hood superstructure, this liner material must be manufactured at the same geographic location as the fume hood superstructure. Interior liner panels shall be 1/4 inch thick epoxy resin sheets of a neutral color. Interior liner panels shall be fastened using stainless steel screws with plastic covered heads. Flame spread of material as measured by ASTM E84 shall be 6.2 or less.
- R. Fume Hood Acid Storage Base Cabinet: Base units under hoods shall be fabricated of cold rolled prime grade roller leveled furniture steel. Cabinet shall be ADA height and shall contain a removable half-depth shelf. The cabinets shall have a one-piece liner insert made of linear low-density polyethylene. The liner insert shall form a one-inch pan at the bottom to retain spillage.

Each door will have a set of louvers at the top and bottom. The door shall be lined with a polyethylene sheet. Each cabinet shall be vented into the fume hood with a 1-1/2 inches vent pipe. Providing a positive airflow directly into the fume hood exhaust system.

- S. Face Velocity Alarm: Fume hoods shall be provided with an alarm system to detect low and high hood face velocities. The alarm system shall indicate the actual face velocity of the hood regardless of sash position. The system shall have an air velocity sensor mounted on the interior side liner of the hood where it is easily accessible for cleaning. The velocity monitor shall have a digital display of the air velocity through the hood face in feet per minute. The alarm signals shall activate any time the face velocity falls below the low velocity alarm set point or rises above the high velocity alarm set point. There shall be both visual and audible alarm signals. The audible alarm shall have a mute. Low and high alarm contacts shall be provided for remote monitoring.
- T. Fume Hoods: Provide access to all sensors, controls, fire dampers.

2.3 SPRAY BOOTH

- A. Acceptable Manufacturer: Paasche Airbrush Company Model FABSF, or as approved.
- B. Type: Galvanized steel floor mounted shelf-type spray booth.
- C. Booth shall require field assembly and shall be furnished complete with sparkless aluminum blade exhaust fan, 24 inch fluorescent light fixture, belt guard, draft gauge, two sets of paint filters, duct collar flange and wall shutter.
- D. Booth shall comply with OSHA, NFPA and EPA regulations.

PART 3 - EXECUTION

3.1 INSTALLATION

- A. Coordinate installation of hoods above equipment being ventilated with equipment supplier and local health authorities.
- B. Factory fabricated range hoods shall be installed in accordance with manufacturer's recommendations. Submit manufacturer's printed installation instructions with operating and maintenance data at completion of Work.
- C. Factory fabricated fume hoods, services and accessories shall be installed in accordance with manufacturer's recommendations. Submit manufacturer's printed installation instructions with operating and maintenance data at completion of Work.
- D. Field assembled spray booths shall be installed in accordance with manufacturer's recommendations. Submit manufacturer's printed installation instructions with operating and maintenance data at completion of Work.
- E. Coordinate the work of this Section with other trades.
- F. Install fume hood on base cabinet, and using base cabinet leg levelers plumb, square, and straight with no distortion. Fasten fume hood to bases from inside the base cabinet, through

perimeter base cabinet strips, using polycarbonate or TFE coated screws. All screws shall be recessed and covered with polypropylene plug, in accordance with manufacturer's instructions. Provide filler panels between top of hood and ceiling. Securely attach access panels but provide for easy removal and secure reattachment. Do not install any damaged units.

- G. Adjust sash, doors, hardware, fixtures and other moving or operating parts to function smoothly.
- H. Fume Hood Manufacturer shall field test installed units using ANSI/ASHRAE 110-1995 to a control level of AI 0.01 ppm or better.

3.2 CLEANING AND PROTECTION OF FINISHED WORK

- A. Remove all remaining protective masking from the cabinet.
- B. Clean finished fume hood, work surfaces, and accessories using cleaning agents recommended by manufacturer. Touch up as required, wipe down and vacuum the interior of the equipment.
- C. Provide all necessary protective measures to prevent exposure of the fume hood to other construction activity during operational test and balancing

****END OF SECTION****

SECTION 160160 AIR FILTRATION

PART 1 - GENERAL

1.1 WORK INCLUDED

- A. The Work of this Section shall consist of the labor, materials and equipment required for installation of air filters.

1.2 SUBMITTALS

- A. Submit for approval in accordance with specified submittal procedures:
 - 1. Throwaway Filters
 - 2. Final Filters

PART 2 - PRODUCTS

2.1 THROWAWAY FILTER

- A. Acceptable Manufacturer: American Air Filter, or Glasfloss.
- B. Throwaway filters shall be a completely disposable unit of cardboard frame and fiberglass filter media with supporting screen on both faces of media. Throwaway filters shall be provided in sizes required by air handling equipment manufacturer.
- C. Thickness: 2 inches.
- D. Initial Resistance: Not more than 0.17 inches WC at 500 fpm maximum face velocity.

2.2 FINAL FILTER

- A. Acceptable Manufacturer: Cam-Farr, or American Air Filter.
- B. Housing: Units shall consist of a completely factory assembled housing with upstream and downstream outwardly turned flanges for installation in central station air handling units. The housing shall be constructed of 16 gage galvanized steel and shall be factory reinforced. Housing shall be insulated.
- C. Filter: Filter element shall be high performance pre formed deep pleated disposable type, laminated reinforced glass fiber media. Filter shall have an initial resistance of not more than 0.55 inches WC at 500 fpm face velocity. Average efficiency of filter shall not be less than 80 percent by ASHRAE Test Std. 52 76, using atmospheric dust. Filters shall be UL listed, Class 2.

- D. Media Retainer Holding Frame: PVC coated welded steel media retainer fastened to 16 gage galvanized steel holding frame with 20 gage galvanized steel gasketed sealer frame.
- E. Size: Noted on Drawings.

PART 3 - EXECUTION

3.1 INSTALLATION

- A. Filters installed in air handling units during the construction period will be considered temporary. Replace disposable media and throwaway filters prior to Owner acceptance of Work.

****END OF SECTION****

SECTION 160170 HEAT TRANSFER

PART 1 - GENERAL

1.1 WORK INCLUDED

- A. The Work of this Section shall consist of the labor, materials and equipment required for installation of heat transfer system components and specialties.

1.2 SUBMITTALS

- A. Submit for approval in accordance with specified submittal procedures:
 - 1. Hydronic Specialties
 - 2. Chemical Water Treatment
 - 3. Electric Heating Cable

PART 2 - PRODUCTS

2.1 HYDRONIC SPECIALTIES

- A. Automatic Air Vents
 - 1. Acceptable Manufacturer: Hoffman No. 77, or Amtrol, Taco.
 - 2. Body: Brass
 - 3. Internal Working Parts: Stainless steel or nonferrous.
 - 4. Operation: Vacuum breaker and float type valve assembly to automatically vent air from system.
- B. Manual Air Vents
 - 1. Acceptable Manufacturer: Taco 417, or Hoffman.
 - 2. Body: Brass.
 - 3. Operation: Quick venting slotted adjustment with positive shutoff ball check.
- C. Relief Valves
 - 1. Acceptable Manufacturer: Bell & Gossett.
 - 2. Relief valves shall be installed in water system at locations and in sizes noted on the Drawings. Valves shall bear the ASME label.
- D. Backflow Preventer
 - 1. Acceptable Manufacturer: Watts Series 009, or Cla Val Company.

2. Type: Reduced pressure.
3. Components: Two independently acting spring loaded toggle lever check valves with automatically operating pressure differential relief valve and two shutoff valves.
4. Accessories: Air gap fitting.
5. Construction: Bronze body with stainless steel internal parts. 150 psig maximum working pressure.

E. Pressure Reducing Valve

1. Acceptable Manufacturer: Cash Acme Type B, or Watts.
2. Type: Diaphragm with self-cleaning seat.
3. Construction: Bronze.
4. Pressure Range: 200 psig maximum inlet and factory set at discharge pressure.
5. Installation: Make-up (domestic cold) water line, furnished with three valve bypass.
6. Standard Features: Self-contained strainer.

F. Calibrated Balancing Valves

1. Acceptable Manufacturer: Bell & Gossett Model CB, or Taco.
2. Construction: Bronze body with threaded ends, brass ball construction with glass and carbon filled TFE seat rings.
3. Standard Features: Differential pressure readout ports across valve seat area. Readout ports to be fitted with internal EPT inserts and check valves. Valve body provided with 1/4 inch NPT tapped drain purge port. Valve furnished with calibrated nameplate indicating specific valve setting. Valve shall be rated for 300 psig at 250 degrees F. Provide portable master meter kit for use during start-up, testing and balancing. Meter kit shall be delivered to Owner at completion of Work.
4. Contractor shall be responsible to select appropriate valve size according to flow characteristics.

2.2 CHEMICAL WATER TREATMENT

- A. Acceptable Manufacturer: Water Treatment by Design, no substitutions. Contact Mark Coldren, (717) 773-5866 or waterrtreaterr@aol.com.
- B. General: Furnish and install a complete water treatment program. Chemicals, service and equipment shall be supplied by a single water treatment company for undivided responsibility. The water treatment chemical and service supplier shall be a recognized specialist, active in the field of industrial water treatment for at least ten years, whose major business is in the field of water treatment, and shall have regional water analysis laboratories, development facilities and service department.

- C. Water Treatment Chemicals: Furnish one year's supply of the recommended formulas for control of scale, pitting and corrosion of the closed loop systems.
- D. Testing Equipment: Furnish testing equipment for treatment control. Equipment shall include apparatus for determination of pH, treatment residual. Furnish training, instruction, and continuing supervision of Owner's operating personnel during the service period.
- E. Water Management Program: Manufacturer shall provide a water management and service program for a period of one year from startup of the system to include the following:
 - 1. Initial water analysis and recommendations.
 - 2. System installation and start up assistance.
 - 3. Training of operating personnel.
 - 4. Quarterly field service, consultation (all of the above performed by a qualified full time local representative), laboratory and technical assistance from the manufacturer's engineering staff.

2.3 ELECTRIC HEATING CABLE

- A. Acceptable Manufacturer: Thermon FLX, or Chromalox, Raychem.
- B. Electric heating cable for exterior piping noted on Drawings shall be self-regulating two wire cable, rated 5.0 watts per foot at 120 volts. Heating cable shall be installed in the cable length per foot of pipe indicated to maintain 40 degrees F minimum water temperature.
- C. Material: Cable shall consist of two 16 AWG nickel plated copper bus wires embedded in parallel in a polymer core tape. Heat tape shall be covered with tinned copper braid and a thermoplastic rubber outer jacket.
- D. Furnish and install SPST, solid state, line sensing waterproof temperature controller.

PART 3 - EXECUTION

3.1 INSTALLATION

- A. Hydronic Piping
 - 1. Water piping shall be installed with a view for even flow and proper venting to and from all apparatus without pockets. Piping system shall be installed for quick, sure and positive drainage. Entire piping system shall present a neat appearance both as to workmanship and grouping. All mains shall pitch up to a high point with automatic air vents provided for air escapement. Provide drains at all system low points.
 - 2. Provide sufficient access for servicing concealed air vents and drain valves. Refer to access panels specified in Section 160020, HVAC Basic Materials.
 - 3. Before the water systems are filled, the water treatment supplier shall be consulted. Treatment chemicals shall be added at time of initial charge.

4. Following the installation and balancing of all piping systems, gage cocks and ball valves at all pressure gages shall be closed to prevent damage to the gage movement.

B. Heat Transfer Equipment

1. Install heat transfer equipment and complete piping connections in accordance with equipment manufacturer's recommendations. Submit manufacturer's printed installation instructions with operating and maintenance data at completion of Work.
2. Piping systems traced with electric heating cable shall be labeled ELECTRIC TRACED on exterior of piping insulation. Refer to pipe identification, Section 160040, HVAC Piping Specialties.

C. Chemical Water Treatment

1. All closed loops shall have a bypass feeder (pot feeder) piped into the circulation line, so that chemical treatment can be introduced into the system. Feeder shall be installed in strict accordance with recommendations of water treatment supplier service representative who is to be consulted prior to installation.
2. Bypass feeders shall be installed across the circulation pump to allow for a minimum 5 psi pressure drop. The discharge side of the pump shall be piped to the bottom of the feeder and the suction side piped to the top to allow an upward flow of material in the feeder. The shot feeder shall be located at least 12 inches off the floor, and manual ball valves shall be located near the bypass feeder to isolate and drain the bypass feeder. One ball valve shall include a memory stop set to keep a trickle flow through the feeder to keep seals wetted.

3.2 TESTS

- A. Water piping shall be leak tested at one and one half times the maximum system design pressure, but not less than 100 psi static pressure for four hours with pressures noted each hour. All leaks shall be repaired and proven leakproof by retesting.
- B. Following tests for piping, systems shall be cleaned by wasting water until it becomes clear after which all strainers shall be cleaned.

3.3 CLEANING, FLUSHING AND FILLING

- A. Following tests for piping, systems shall be flushed by wasting water until it becomes clear. Use water meter to fill, record, and tag (permanent tag) the system with the actual system volume. Chemical cleaner shall be added to remove grease, mill oil, organic soil, flux, iron oxide, etc. All terminal control valves and valves at end of runs shall be opened so that cleaner is circulated through the whole system. After cleaning, all strainers shall be flushed, and strainer screens cleaned or replaced. Once closed loop is chemically cleaned, system shall be dumped and flushed with water so that all cleaning chemical is removed from the system. Once complete, scale and corrosion inhibitor shall be added.

END OF SECTION

**SECTION 160180
CENTRAL STATION AIR HANDLING UNITS**

PART 1 - GENERAL

1.1 WORK INCLUDED

- A. The Work of this Section shall consist of the labor, materials and equipment required for installation of central station air handling units and associated components.

1.2 RELATED SECTIONS

- A. Section 160020, HVAC Basic Materials: Equipment nameplates and motors
- B. Section 160070, HVAC Sound and Vibration Control: Vibration isolators.
- C. Section 160090, Variable Frequency Drives: VFDs.
- D. Section 160160, Air Filtration: Filters.
- E. Section 160210, Building Automation System: Controls.
- F. Section 160220, Testing, Adjusting, and Balancing of HVAC System: Testing, adjusting, and balancing procedures.

1.3 SUBMITTALS

- A. Submit for approval in accordance with specified submittal procedures:
 - 1. Rooftop Air Handling Units, including roof curbs
 - 2. Wiring diagrams for power and 120-volt circuit for access section lights and receptacles to single point power connection.
- B. Manufacturer's published fan curve data shall be included with shop drawing submittal data for air handling units. Fan curve information shall include operating point, RPM curve for operating point, minimum and maximum RPM curves for fan, system curve and brake horsepower curves. Tabular fan performance charts are not an acceptable substitute for fan curve data. Shop drawing submittals for air handling equipment will be returned without Owner's review if the fan curve data is not included with the submittal.

1.4 QUALITY ASSURANCE

- A. Electrical Components, Devices, and Accessories: Listed and labeled as defined in NFPA 70, by a qualified testing agency, and marked for intended location and application.
- B. NFPA Compliance: Comply with NFPA 90A for design, fabrication, and installation of air-handling units and components.

- C. ARI Certification: Air-handling units and their components shall be factory tested according to ARI 430, "Central-Station Air-Handling Units," and shall be listed and labeled by ARI.
- D. Fan rating shall be AMCA certified.

1.5 SOURCE QUALITY CONTROL

- A. Fan Sound-Power Level Ratings: Comply with AMCA 301, "Methods for Calculating Fan Sound Ratings from Laboratory Test Data." Test fans according to AMCA 300, "Reverberant Room Method for Sound Testing of Fans." Fans shall bear AMCA-certified sound ratings seal.
- B. Fan Performance Rating: Factory test fan performance for airflow, pressure, power, air density, rotation speed, and efficiency. Rate performance according to AMCA 210, "Laboratory Methods of Testing Fans for Aerodynamic Performance Rating."

1.6 EXTRA MATERIALS

- A. Furnish extra materials that match products installed and that are packaged with protective covering for storage and identified with labels describing contents.
 - 1. Filters: One set for each air-handling unit.
 - 2. Fan Belts: One set for each air-handling unit fan.

PART 2 - PRODUCTS

2.1 ROOFTOP AIR HANDLING UNIT

- A. Manufacturer
 - 1. Basis of Design: Trane.
 - 2. Other Acceptable Manufacturers: Carrier Corp., Johnson Controls, Inc., Daikin.
- B. Arrangement
 - 1. Arrange air handling unit sections as indicated on Drawings.
- C. Unit Construction
 - 1. General
 - a. Designed and built specifically for outdoor installation on top of roof curb. Weatherized indoor air handlers will not be acceptable.
 - b. Leakage Performance: All casings shall be constructed to minimize leakage and shall be in accordance with duct and plenum leakage class required by the International Energy Conservation Code or better.
 - 1) The casing air leakage shall not exceed leak class 6 ($C_L = 6$) per ASHRAE 111 at specified casing static pressure (P in inches w.g.) where maximum casing leakage ($\text{cfm}/100 \text{ ft}^2$ of casing surface area) = $C_L \times P^{0.65}$.
 - 2) Air leakage shall be determined at 1.25 times maximum casing static pressure up to a maximum of +/- 8 inches w.g. Specified air leakage shall be

accomplished without the use of caulk. Total estimated air leakage shall be reported for each unit in CFM, as a percentage of supply air, and as an ASHRAE Leakage Class.

2. Floor
 - a. Aluminum, insulated, with tread plate in fan and filter access sections.
3. Wall and Roof Panels
 - a. Panels and unit roof double wall construction with panel insulation system providing a minimum R-13. Insulation shall conform to NFPA 90 requirements.
4. Unit Paint
 - a. Exterior surface of unit casing prepared and coated with minimum 1.5 mil enamel finish. Factory-finish able to exceed 500 hour salt spray solution (5 percent) without any sign of red rust when tested in accordance with ASTM B117. Manufacturer's standard paint color..
5. Unit Roof
 - a. Inner roof surface installed to prevent air bypass between internal components. Outer roof sloped a minimum 0.125 inches per foot either from one side of unit to the other, or from center to sides, with overhangs.
6. Pipe Cabinet
 - a. External, factory-assembled and supplied of construction to match unit casing.
 - b. Shipped separately and field-installed external to the unit.
 - c. Manufacturer's standard internal pipe cabinet will be acceptable.
7. Primary Drain Pans
 - a. Furnish full length in all coil and humidifier sections.
 - b. Insulated, double wall, stainless steel.
 - c. Fully accessible and cleanable.
 - d. Designed in accordance with ASHRAE 62.1 being of sufficient size to collect all condensation produced from the coil and sloped in two planes, pitched toward drain connections, promoting positive drainage to eliminate stagnant water conditions when unit is installed level and trapped per manufacturer's requirements.
 - e. Drain connections of same material as pans, located at the lowest point of the pan and accessible from outside the unit on both sides. Threaded connection with stainless steel drain plug. The connection shall be sized to preclude drain pan overflow under any normally expected operating condition.
8. Intermediate Drain Pans
 - a. Provide for units with stacked coils to collect condensate from each row.
 - b. Construction same as specified for primary drain pan.
 - c. Intermediate drain pan shall begin at the leading face of the coil and be of sufficient length extending downstream to prevent condensate from passing through the airstream of the lower coil.
 - d. Drop tubes to guide condensate to the primary drain pan to prevent flooding of lower coils.
9. Access Doors
 - a. All components shall be accessible via access doors and removable panels. Provide on drive side of fan sections.
 - b. Formed and reinforced double wall and insulated panels of same materials and properties as casing.

- c. At least 18 inches wide by full height of unit casing up to a maximum height of 72 inches.
- d. Minimum of two ball-bearing hinges or stainless steel piano hinge on each door with two wedge-lever-type latches, operable from outside and inside the unit. Doors attached by screws will not be acceptable.
- e. Arranged to open against air-pressure differential.
- f. Neoprene gasketing around full perimeter to prevent air leakage.

D. Marine Lights and Receptacles

- 1. Furnish in fan, filter and full-sized access sections.
- 2. Lights: Factory-mounted, energy efficient, long-life fluorescent, UL listed for wet locations with junction box.
- 3. Receptacles: GFCI.
- 4. Dedicated 120 volt circuit separate from main power to unit. Wired in field.

E. Curb

- 1. Provided by unit manufacturer.
- 2. Constructed of galvanized steel with a wood nailing strip factory installed.
- 3. Jointers, gasketing and bolts for assembly provided as required.
- 4. Unit condensate drainage system sized and trapped outside unit roof curb to provide adequate condensate drainage at specified fan suction pressures.
- 5. Curb designed so that unit will be installed level.

F. Fan Sections

- 1. General
 - a. Housed fan performance certified in accordance with ARI Standard 430.
 - b. AMCA seal.
- 2. Wheels
 - a. Double width, double inlet, multi-blade type. Backward inclined (BI) or airfoil (AF) blade design as required for stable operation and optimum energy efficiency.
- 3. Shafts
 - a. Designed for continuous operation at maximum-rated fan speed and motor horsepower, and with field-adjustable alignment.
 - b. Turned, ground, and polished hot-rolled solid steel with keyway. Ship with a protective coating of lubricating oil.
 - c. Designed to operate at no more than 70 percent of first critical speed at top of fan's speed range.
- 4. Bearings
 - a. Self-aligning, antifriction bearings with an L50 life of 200,000 hours. Bearings shall be equipped with extended grease lines allowing for lubrication from the drive side of the fan from a readily accessible location.
- 5. Fan Isolation
 - a. Fan isolated from unit casing by a flexible connection.

- b. Fan and motor assembly internally isolated from unit casing with 1 inch (nominal 4000 cfm and under) or 2 inch (above 4000 cfm) deflection spring isolators, furnished and installed by unit manufacturer.
6. Belt Drives
 - a. Factory mounted drive assemblies with adjustable alignment and belt tensioning.
 - b. Drives shall be constant speed with fixed pitch sheaves.
 - c. Selected at a minimum of 1.2 service factor based on rated nameplate HP.
 - d. Belts shall be oil-resistant, heat-resistant, non-sparking and anti-static in matched sets for multiple-belt drives. Provide a minimum of 2 belts, each rated to carry full load in case one breaks.
 7. Motors
 - a. Integrally mounted to an isolated fan assembly.
 - b. Mounted inside unit on adjustable base to permit drive-belt adjustment.
 - c. Refer to Section 160020 for required characteristics.
 8. Fan Modulation
 - a. Field mounted variable frequency drive to control fan speed for variable air volume applications.
 - b. Refer to Section 160080.
 9. Belt Guard
 - a. Expanded metal mesh belt guard to allow inspection of belts and pulleys without removal. Belt guard shall be attached with hinges and/or quick release fasteners operable without tools. A tachometer hole shall be aligned with the fan shaft.
 10. Electrical Disconnect
 - a. Provide integral mounted electrical disconnect for fan motor.

G. Coil Sections

1. General:
 - a. Coils manufactured by the unit manufacturer.
 - b. All coils enclosed within unit casing. Coil headers and return bends shall not be exposed.
 - c. Coils shall be mounted in unit casing to be accessible for service and removable from unit side without disassembling the unit.
 - d. Capacities, pressure drops and selection procedure shall be certified in accordance with ARI 410.
 - e. Provide at least 24 inches of access space upstream and between each coil with doors to facilitate installation of sensors and for inspection and cleaning.
 - f. All coils shall be air vented and arranged for proper drainage.
 - g. Fabricate coil section to allow removal and replacement of each coil segment and to allow in-place access for service and maintenance of coil(s). Coils shall not act as structural component of unit or support other coils.
 - h. Units with stacked coils shall have an intermediate drains pan to collect condensate from each row of coils. Intermediate drain pans shall have drop tubes to guide condensate to the main drain pan, thus preventing flooding of lower coils that would result in moisture carryover.
 - i. On applications that will condense moisture, such as typical air conditioning cooling/dehumidification and exhaust air heat recovery provide coil casings of minimum 0.0625 inch thick stainless steel channel frames.

- j. Access doors shall be provided on upstream side of all coils to facilitate inspection and cleaning.
 - 2. Water Coils
 - a. Aluminum fins and seamless copper tubes. Fins shall have collars drawn, belled and firmly bonded to tubes by means of mechanical expansion of tubes.
 - b. Casing, tracks and supports
 - 1) Hot Water: Galvanized steel.
 - 2) Chiller Water: Stainless steel.
 - c. Round copper headers with vent connections at the highest point and drain connections at the lowest point. Steel pipe headers will not be acceptable.
 - d. Factory tested to 300 psig according to ARI 410 and ASHRAE 33.
 - e. Supply and return header connections shall be clearly labeled such that direction of coil water-flow is counter to direction of unit air-flow.
- H. Energy Recovery Section
 - 1. Air-to-air, fixed plate heat exchanger integral to the unit and sized per the ventilation requirement of the unit.
 - 2. Performance and Certification
 - a. Heat exchanger shall be certified to ANSI/AHRI Standard 160 and bear the AHRI 1060 label.
 - b. Heat exchanger face velocity shall not exceed 500 fpm.
 - c. Performance shall meet or exceed specified effectiveness.
 - 3. Construction
 - a. Exchangers shall be cross-flow type with no moving parts or secondary heat transfer surfaces.
 - b. Plates shall be minimum 99.5% aluminum and formed with a plate profile for maximum efficiency and cleanability, and minimizes pressure loss.
 - c. Access to all four faces of the exchanger shall be provided for cleaning and inspection.
 - d. Drain pans shall be provided under both the supply and exhaust sides of the exchanger. Drain pans shall be stainless steel construction as provided in other unit sections.
 - 4. Dampers
 - a. Heat exchanger shall be provided with frost control dampers and bypass dampers.
- I. Filter Sections
 - 1. Filter section(s) shall have angled filter racks and guides to accommodate specified filter types and thicknesses, at least one access door for filter replacement, and filter block-offs to prevent air bypass around filters.
 - 2. Factory installed Magnehelic gage to read pressure drop across each filter bank.
 - 3. Refer to Section 160160 for filter types and thicknesses.
- J. Air Intake and Exhaust Sections
 - 1. Sections shall be provided with dampers and hoods.
 - a. Dampers: Heavy gage aluminum, airfoil-shaped damper blades in an aluminum frame with flexible metal compression jamb seals, neoprene blade edge seals, and molded synthetic bearings.

- b. Actuator: Refer to Section 160210, Building Automation System.
- c. AMCA certified.

K. Other Sections

- 1. Inlet Hood
 - a. Designed to not permit moisture to enter the unit at 100 percent airflow through hood.
 - b. Heavy-duty bird screen.
- 2. Access/Inspection
 - a. Supplied in length(s) and position(s) with access door to allow additional access/inspection and space for field installed components.
- 3. Discharge Plenum
 - a. Supplied to effectively turn air.
 - b. Safety guard over open bottom connections.

L. Controls

- 1. Building Automation System Controls: Refer to Section 160210.

PART 3 - EXECUTION

3.1 INSTALLATION

A. General:

- 1. Install air handling units and complete piping and wiring connections in accordance with equipment manufacturer's published installation instructions and recognized industry standards. Submit manufacturer's published installation instructions with operating and maintenance data at completion of Work.
- 2. Coordinate installation of air handling units with other Work, including roof decking, ductwork, and piping.
- 3. Provide access space around air handling units for service as recommended by manufacturer.

B. Support:

- 1. Install units level to prohibit excessive vibration and insure longer life.
- 2. Roof Mounted Units: Roof curbs provided as Work of this Section shall be coordinated with requirements of the roofing subcontractor. Product data submittals for roof curbs, with, or without, cants will be considered in compliance with roofer's requirements.

C. Piping Connections:

- 1. Provide piping, valves, gages, supports, flexible connectors and accessories as indicated.
- 2. Install piping adjacent to air handling units to allow service and maintenance.

3. Install condensate drain, complete with trap, on all cooling coils furnished with drain pan. Provide trap seal according to unit manufacturer's recommendations.

D. Ductwork Connections

1. Connect ductwork to air handling units mounted on vibration isolators with flexible connections.

E. Electrical Wiring:

1. Install electrical devices furnished by manufacturer but not specified to be factory – mounted. Furnish copy of manufacturer's wiring diagram to Electrical Contractor.
2. Verify that electrical wiring installation is in accordance with manufacturer's submittal and installation requirements of Section 18.
3. Provide positive equipment ground for air handling unit components.
4. Do not proceed with equipment start-up until wiring installation is acceptable to equipment installer.

- F. Do not operate units for any purpose, temporary or permanent, until ductwork is clean, filters are in place, bearings lubricated, and fans have been test run under observation. Replace temporary filters used during construction with new, clean filters prior to start of air system testing and balancing.

3.2 FIELD QUALITY CONTROL

- A. Upon completion of installation of units, and after motor has been energized with power source, perform the following tests and inspections with the assistance of a factory-authorized service representative to demonstrate compliance with requirements:

1. Verify that shipping, blocking, and bracing are removed.
2. Verify that unit is secure on mountings and supporting devices and that connections to ducts and electrical components are complete. Verify that proper thermal-overload protection is installed in motors, starters, and disconnect switches.
3. Verify that cleaning and adjusting are complete.
4. Disconnect fan drive from motor, verify proper motor rotation direction, and verify fan wheel free rotation and smooth bearing operation. Reconnect fan drive system, make final alignments of pulleys and belt tension, and install belt guards.
5. Adjust damper linkages for proper damper operation.
6. Verify lubrication for bearings and other moving parts.
7. Verify that manual and automatic volume control and fire dampers in connected ductwork systems are in fully open position.

- B. See Section 160220 for testing, adjusting, and balancing procedures. Prepare and submit test and inspection reports.

- C. Test and adjust controls and safeties. Controls and equipment will be considered defective if they do not pass tests and inspections.

- D. Remove and replace malfunctioning units that cannot be satisfactorily corrected and retest as specified above.

3.3 START-UP SERVICES

- A. Manufacturer shall provide start-up service on units to include control interface with BAS.

****END OF SECTION****

SECTION 160190 UNITARY EQUIPMENT

PART 1 - GENERAL

1.1 WORK INCLUDED

- A. The Work of this Section shall consist of the labor, materials and equipment required for installation of unitary equipment.

1.2 RELATED SECTIONS

- A. Section 160020, HVAC Basic Materials: Equipment nameplates and motors.
- B. Section 160230, Wiring of HVAC Equipment.
- C. Section 160210, Building Automation System: Controls.

1.3 SUBMITTALS

- A. Submit for approval in accordance with specified submittal procedures:
 - 1. Fan Coil Units
- B. Product Data: Include rated capacities, furnished specialties, and accessories for each type of product indicated. Include performance data in terms of capacities, outlet velocities, static pressures, sound power characteristics, motor requirements, and electrical characteristics.
- C. Shop Drawings: Diagram power, signal, and control wiring.
- D. Samples for Color Selection: For units with factory-applied color finishes.
- E. Field quality-control test reports.
- F. Operation and Maintenance Data: To include in operation, and maintenance manuals.

1.4 QUALITY ASSURANCE

- A. Electrical Components, Devices, and Accessories: Listed and labeled as defined in NFPA 70, Article 100, by a testing agency acceptable to authorities having jurisdiction, and marked for intended use.
- B. ASHRAE Compliance: Applicable requirements in ANSI/ASHRAE Standard 62.1, Section 5 - "Systems and Equipment" and Section 7 - "Construction and System Start-up."
- C. Minimum Energy Efficiency: ANSI/ASHRAE/IESNA Standard 90.1: Comply with applicable requirements in Section 6 - "Heating, Ventilating, and Air-Conditioning".

1.5 EXTRA MATERIALS

- A. Furnish extra materials described below that match products installed and that are packaged with protective covering for storage and identified with labels describing contents.
 - 1. Filters: One set of filters for each unit.

PART 2 - PRODUCTS

2.1 FAN COIL UNITS

- A. Acceptable Manufacturer: Trane, or Johnson Controls, Carrier, Daikin.
- B. Type: Water, without outside air, UL approved.
- C. Cabinet: 18 gage steel, phosphatized, finished with baked enamel of color selected by Owner. Removable front panel. Steel bar-type discharge grille and stamped louver inlet shall be provided for exposed units.
- D. Insulation: Cabinet thermally and acoustically insulated with closed cell insulation.
- E. Water Coil: Seamless copper tubes mechanically bonded to aluminum fins, leak tested to 100 psig air under water. ARI certified capacities.
- F. Fan: Aluminum or galvanized steel, forward curved, double width, centrifugal type, statically and dynamically balanced.
- G. Motor: Multi speed split capacitor with UL listed thermal overload protection.
- H. Filter: Pleated media throwaway type.
- I. Drain Pans: 18 gage galvanized steel or non-corrosive ABS main pan with closed cell insulation. Molded plastic auxiliary pan shall extend under all end pocket piping and valving.
- J. Controls: Refer to Section 160210.
- K. Construction: Basic enclosure shall be provided with inlet and outlet arrangement indicated on Drawings.

PART 3 - EXECUTION

3.1 INSTALLATION

- A. Install unitary equipment and complete piping connections in accordance with equipment manufacturer's recommendations. Submit manufacturer's printed installation instructions with operating and maintenance data at completion of Work.

- B. Filters installed in unitary equipment during the construction period will be considered temporary. Provide new throwaway filter(s) at time of Owner acceptance of Work.
- C. Install condensate drain, complete with trap, on all cooling coils furnished with drain pan. Provide trap seal according to equipment manufacturer's recommendations.

3.2 FIELD QUALITY CONTROL

- A. Perform the following field tests and inspections and prepare test reports:
 - 1. Leak Test: After installation, charge system and test for leaks. Repair leaks and retest until no leaks exist.
 - 2. Operational Test: After electrical circuitry has been energized, start units to confirm proper motor rotation and unit operation.
 - 3. Test and adjust controls and safeties. Replace damaged and malfunctioning controls and equipment.
- B. Remove and replace malfunctioning units and retest as specified above.

END OF SECTION

SECTION 160200
TERMINAL HEATING UNITS

PART 1 - GENERAL

1.1 WORK INCLUDED

- A. The Work of this Section shall consist of the labor, materials and equipment required for installation of terminal heating units.

1.2 SUBMITTALS

- A. Submit for approval in accordance with specified submittal procedures:
 - 1. Baseboard Radiation
 - 2. Convectors
 - 3. Unit Heaters
 - 4. Wall Insert Heaters

PART 2 - PRODUCTS

2.1 BASEBOARD RADIATION, HOT WATER

- A. Acceptable Manufacturer: Rittling Model PIBG, or Sterling, Vulcan.
- B. Style: Pedestal enclosure, top outlet bar grille, single row high.
- C. General: Furnish unit complete with enclosure with grille, heating element, hangers and accessories such as corner pieces, fillers, sleeves and end caps to effect installation of individual piece or wall-to-wall applications. All components, except heating elements, to be phosphatized and finished with baked enamel of color selected by Architect.
- D. Construction: 14 gage CRS, phosphatized. 3/4 inch pedestal with floor flange .
- E. Grille: heavy duty aluminum extrusion, R-204 clear anodized finish, pencilproof grille.
- F. Heating Elements: Seamless copper tubing mechanically expanded into fin collars and aluminum fins.
- G. Joints: Internal joggle joiners for hairline joints without any external fasteners.

2.2 CONVECTOR, HOT WATER

- A. Acceptable Manufacturer: Sterling, or Airtherm, American Air Filter.

- B. Type: Wall hung.
- C. Style: Front outlet.
- D. Cabinet: Tamperproof, 20 gage steel back and end panels, 18 gage steel top and front panels, suitably braced to provide stiffness. Phosphatized and finished with baked enamel of color selected by Owner.
- E. Front Panel: Removable, for access to interior.
- F. Damper: Factory installed dial type.
- G. Heating Elements: Seamless copper tubing mechanically expanded into fin collars and brazed to cast iron or steel header with silver solder, aluminum fins, ribbed steel side plates and fin tube supports to be protected against corrosion.
- H. Test Pressure: Coil leak tested at 150 psig air under water.
- I. Installation: Fully recessed wall model, as indicated on Drawings.
- J. Accessory end pockets. Both ends.
- K. Accessory access door.

2.3 HORIZONTAL UNIT HEATER, HOT WATER

- A. Acceptable Manufacturer: Trane Model S horizontal, or Modine, Airtherm, Sterling.
- B. Casing: Die-formed steel, phosphatized, finished in baked enamel. Top plate shall be provided with threaded or drilled hanger connections.
- C. Heating Elements: 0.025 inch thick wall seamless copper tubing with aluminum fins mechanically bonded to tubing.
- D. Coil Test Pressure: 300 psig air tested under water.
- E. Fan Guard: Removable heavy duty wire cage.
- F. Motor: Continuous duty, direct connected to fan, with built-in automatic reset thermal protection.
- G. Fan: Aluminum or steel blades, statically and dynamically balanced.
- H. Outlet: Adjustable discharge louver.
- I. Controls: Refer to Section 160210, Building Automation System. Power disconnect switch.

2.4 WALL INSERT HEATER, HOT WATER

- A. Acceptable Manufacturer: Beacon/Morris or as approved.

- B. Cabinet: Tamperproof, heavy duty steel front cover with downflow discharge louvers and baked enamel finish.
- C. Heating Elements: Seamless copper tubing with aluminum fins mechanically bonded to tubing.
- D. Motor: Enclosed, continuous duty, direct connected to fan, permanently lubricated.
- E. Fan: Aluminum or steel blades, propeller.
- F. Controls: Refer to Section 160210, Building Automation System. Power disconnect switch.

PART 3 - EXECUTION

3.1 INSTALLATION

- A. Install terminal heating units and complete piping connections in accordance with unit manufacturer's recommendations. Submit manufacturer's printed installation instructions with operating and maintenance data at completion of Work.

****END OF SECTION****

**SECTION 160210
BUILDING AUTOMATION SYSTEM**

PART 1 - GENERAL

1.1 WORK INCLUDED

- A. The Work under this Section shall consist of the labor, materials and equipment required for installation of the building automation system and automatic temperature control system (BAS/ATC). The BAS/ATC shall control the existing equipment modified by the project.

1.2 SUBMITTALS

- A. Submit complete BAS/ATC shop drawings for Engineer's approval prior to installation or fabrication of any equipment. Submittal data shall include a schedule of all devices to be installed, including proposed locations. Devices shall be properly sized and selected for optimum system operation.
- B. Deviations from the sequence of control specified herein shall be clearly noted in the sequence of control furnished with shop drawing submittals.

- 1.3 Submittals shall include software, control equipment, control valves, motor-operated dampers, damper actuators, sequence of operations, points list, complete system drawings, etc. Equipment submittals shall include airflow monitoring systems, duct-mounted lab supply boxes (VAV), duct-mounted lab exhaust boxes (LEV) and laboratory airflow control systems.

1.4 QUALITY ASSURANCE

- A. The BAS/ATC system shall be designed, installed, commissioned and serviced by factory trained personnel.

1.5 SERVICE AND GUARANTEE

- A. At completion of system installation, BAS/ATC system manufacturer shall adjust all thermostats, control valves, motors and other equipment provided under this contract with trained personnel in the direct employ of BAS/ATC system manufacturer. He shall place said equipment in complete operating condition subject to approval of Engineer, and instruct Owner's operating personnel in the operation of the system.
- B. BAS/ATC system, specified herein, shall be guaranteed free from defects in workmanship and material under normal use and service for a period of 1 year after acceptance by Owner.
- C. Equipment herein described proven to be defective in workmanship or material during the guarantee period shall be adjusted, repaired, or replaced by BAS/ATC system manufacturer at no charge to Owner.

- D. BAS/ATC system manufacturer shall maintain an up to date software program to provide Owner with backup in the event of system failure at any future date.

1.6 WIRING

- A. All power and wiring required by the BAS/ATC system, controllers and required appurtenances shall be provided by BAS/ATC system supplier.
- B. Detailed wiring diagrams and complete field supervision shall be provided by system installer.
- C. System installer shall furnish and install control devices specified in this Section unless specifically stated otherwise.
- D. Maximum allowable voltage for wiring inside control panels shall be 120V.
- E. All wiring shall conform to the National Electrical Code and requirements of Section 18.
- F. Control wiring penetrations at wall-mounted sensors shall be calked and sealed to prevent air leakage.

PART 2 - PRODUCTS

2.1 MANUFACTURER

- A. Basis of Design, to match existing system: Siemens Industry Building Technologies; Apogee Automation System.
 - 1. System shall be an extension of the existing Siemens system on the campus, contact David Hebel at Siemens 717-791-4208 or david.hebel@siemens.com.
 - 2. Automated Logic, 4501 Chambers Hill Road, Harrisburg, PA 17111. (717) 909-7000.
- B. Substitutions: None.

2.2 GENERAL

- A. BAS/ATC system shall include, but not be limited to, the following components:
 - 1. Existing operator interface.
 - 2. System application controllers shall manage the energy and building management capacities of the automation system, as well as, facilitate remote communications and central monitoring.
 - 3. Application specific controllers shall provide distributed, pre-engineered control, specific to the mechanical equipment specified.
 - 4. Custom application controllers with distributed custom programming capability shall provide control for nonstandard control sequences.
 - 5. Data communications capability shall allow data to be shared between the various controllers in the architecture.

6. System software shall include system software for global application functions, application software for distributed controllers, and operator interface software.
 7. End devices such as sensors, actuators, dampers, valves, and relays.
- B. The failure of any single component shall not interrupt the control strategies of other operational devices. System expansion shall be through the addition of end devices, controllers, and other device specified herein.

2.3 SYSTEM APPLICATION CONTROLLERS

- A. BAS/ATC system shall be composed of one independent, stand alone, microprocessor based system application controller to manage the global strategies described in application software section.
- B. System application controller shall have ample memory to support its operating system, database, and programming requirements.
- C. Operating system of the system application controller shall manage the input and output communications signals to allow distributed controllers to share real and virtual point information and allow central monitoring and alarms.
- D. Data shall automatically be shared between system application controllers when they are networked together.
- E. Database and custom programming routines of remote system application controllers shall be editable from single operator station.
- F. System applications controllers shall have the capability of being remotely monitored over telephone modem. Additional capabilities shall include automatically dialing out alarms, gathering alarms, reports and logs, programming a downloading databases.
- G. Controller shall continually check status of all processor and memory circuits. If a failure is detected, controller shall:
 1. Assume a predetermined failure mode.
 2. Emit an alarm.
 3. Display card failure identification.

2.4 CONTROL VALVES

- A. Two-way or three-way mixing valves as indicated with linkage for connection to valve operator. Maximum pressure drop shall be 3 psig at full flow.

2.5 VALVE ACTUATORS

- A. Valve actuators shall be electronic, spring return, low voltage (24VAC), and properly selected for valve body and service.

- B. Actuators shall be fully proportioning and be spring return for normally open or normally closed operation as called out in the sequence of operations.

2.6 TEMPERATURE SENSORS

- A. Temperature sensors shall be integrated circuit temperature detector sensors (RTD) or thermistor as dictated by requirements herein.
- B. Immersion sensors shall be provided with a separable stainless steel well.
- C. Space sensors shall be equipped with setpoint adjustment and override switch. Space sensor shall have port for connecting laptop computer.
- D. Accuracies shall be plus or minus 1 degree F for standard applications. Where high accuracy is required, accuracies shall be plus or minus 0.2 degrees F.

2.7 PRESSURE SENSOR

- A. The pressure sensor shall provide a 4 to 20 mA output. Sensor accuracy shall be plus or minus 1 percent of sensing range.
- B. Sensor shall have a normal operating pressure range of 0 to 100 psig and proof pressure of 200 psig.

2.8 DAMPER OPERATOR, 2-POSITION

- A. Features: 24 volt, two position, spring return to the closed or open position with 1 SPDT auxiliary switch, as indicated in the sequences. Provide 120 to 24 volt transformer where required.

2.9 STATUS TYPE CURRENT SENSORS

- A. Shall vary output voltage proportional to change in sensed current. Multiple range units shall be provided to allow for varying site conditions. Low range units shall offer ranges of 10, 20 and 50, 100 and 200 amps. Provide actual analog current indication for status of all motors one horsepower and larger. Provide switch points to determine motor status in software.

2.10 MOTOR OPERATED DAMPERS

- A. Remote mounted motor operated dampers shall be furnished by the BAS/ATC system manufacturer and installed by the Mechanical Contractor. Dampers shall be opposed or parallel blade type as required for the application. Dampers shall be of the low leakage type of not more than 1 percent leakage based on a 4 inch WC static pressure and a 2000 feet per minute approach velocity. Seals on damper blades and frames shall be replaceable in the field. Furnish and install for motor operated dampers, including motor operated dampers furnished by the unit manufacturer, piston type damper actuators providing ample power to smoothly position

damper to any position. Damper operators shall be equipped with pilot positioners where specified or required to meet the specified sequence of operation.

2.11 AIRFLOW MONITORING SYSTEMS

- A. Manufacturer's: Ebtron Gold Series.
- B. Measurement device shall consist of one or more sensor probe assemblies and a single, remotely mounted, microprocessor-based transmitter. Each sensor probe assembly shall contain one or more independently wired sensor housings. The airflow and temperature readings calculated for each sensor housing shall be equally weighted and averaged by the transmitter prior to output. Pitot tubes and arrays are not acceptable. Vortex shedding flow meters are not acceptable.
- C. Duct and Plenum Sensor Probe Assemblies:
 - 1. Each sensor housing shall be calibrated at a minimum of 16 airflow rates and have an accuracy of +/-2% of reading over the entire operating airflow range. Each sensor housing shall be calibrated to standards that are traceable to the National Institute of Standards and Technology (NIST).
 - 2. The number of sensor housings at each location shall comply with the manufacturer's requirements.
 - 3. A single manufacturer shall provide both the airflow/temperature measuring probe(s) and transmitter at a given measurement location.
- D. The transmitter shall have a 16 character alpha-numeric display capable of displaying airflow, temperature, system status, configuration settings and diagnostics. Configuration settings and diagnostics shall be accessed through a pushbutton interface on the main circuit board. Airflow shall be field configurable to be displayed as a velocity or a volumetric rate.
- E. The transmitter shall have a power switch and operate on 24 VAC (isolation not required). The transmitter shall use a switching power supply fused and protected from transients and power surges.
- F. The transmitter shall be capable of communicating with the host controls using one of the following interface options:
 - 1. Linear analog output signal: Field selectable, fuse protected and isolated, 0-10VDC and 4-20mA (4-wire)
 - 2. RS-485: Field selectable BACnet-MS/TP, ModBus-RTU and Johnson Controls N2 Bus
 - 3. 10 Base-T Ethernet: Field selectable BACnet Ethernet, BACnet-IP, ModBus-TCP and TCP/IP
- G. LonWorks Free Topology.

2.12 LAB CONTROLS

- A. Duct-mounted Laboratory Supply Boxes (VAV) and Laboratory Exhaust Boxes (LEV) type boxes:
1. Duct-mounted VAV and LEV shall be provided by BAS/ATC manufacturer and controlled by the appropriate control strategy, as noted below.
 - a. Laboratory Supply Boxes, VAV
 - 1) Air terminals shall be industrial-grade with a pre-packaged airflow measurement system. Terminals shall consist of a round inlet and rectangular outlet, a round single blade control damper and $\frac{3}{4}$ inch fiber-free foam insulation. Unit construction shall be 22 gage galvanized steel. Flow sensor type shall be four-quadrant with 12 sensing points, center averaging and signal amplification.
 - b. Laboratory Exhaust Boxes, LEV
 - 1) Air terminals for non-corrosive airstreams, such as general exhaust air, shall be constructed of 22-gauge galvanized steel. The damper shaft shall be zinc-plated steel with Teflon shaft bushings. Unit shall consist of a round duct casing, damper blade and air flow sensor. Flow sensor type shall be four-quadrant with 12 sensing points, center averaging and signal amplification.
- B. Laboratory Airflow Control System
1. The Laboratory Airflow Control System (LACS) shall be a microprocessor-based airflow control system that is used for research laboratories and other critical room environments. The LACS shall have a Bacnet™ interface for bi-directional communication with the BAS/ATC. The LACS shall provide data values, alarms, and set points used in each room-environment control scheme to the BAS/ATC, and also provide remote diagnostics and comprehensive reports and trends through the BAS/ATC.
 2. Each individual lab zone shall have a dedicated laboratory airflow control system. Each dedicated laboratory airflow control system shall support a minimum of twenty (20) network controlled airflow devices.
 3. The controller shall be integrated via Bacnet™ with the following points as a minimum;
 - a. Supply/Make-up Airflow (CFM).
 - b. Exhaust Airflow (CFM).
 - c. Total Lab Exhaust Airflow (CFM).
 - d. Total Lab Supply Airflow (CFM).
 - e. Room Offset (CFM).
 - f. Occupied and unoccupied modes (command and status) of operation and associated command and adjustable points. (i.e. Temperature set point, minimum and maximum airflow set point).
 4. The Control Unit shall also accept direct input signals from the BAS/ATC.
 5. Control Functions
 - a. Pressurization Control
 - 1) The laboratory control system shall control supply and auxiliary exhaust airflow devices in order to maintain a volumetric offset (either positive or negative). Offset shall be maintained regardless of any change in flow or static pressure. This offset shall be field adjustable and represents the

- volume of air, which will enter (or exit) the room from the corridor or adjacent spaces.
- 2) The pressurization control algorithm shall sum the flow values of all Supply and Exhaust airflow devices and command appropriate controlled devices to new set points to maintain the desired offset. The offset shall be adjustable.
 - 3) The pressurization control algorithm shall support the ability to regulate the distribution of total supply airflow across multiple supply airflow control devices or total general exhaust airflow across multiple exhaust airflow control devices in order to optimize air distribution in the space.
- b. Temperature Control
 - 1) The laboratory control system shall regulate the space temperature through a combination of volumetric thermal override and control of reheat coils and baseboard radiation. The baseboard radiation shall be used as the first stage of heat. Separate cooling and heating set points shall be writable from the BAS/ATC.
 - c. Occupancy Control
 - 1) The laboratory control system shall have the ability to change the minimum ventilation (supply airflow) and temperature control set points, based on the occupied state, in order to reduce energy consumption when the space is not occupied. The occupancy state may be set by either the BAS/ATC, as a scheduled event, or through the use of a local occupancy sensor or switch. The laboratory control system shall support a local occupancy override button that allows a user to override the occupancy mode and set the space to occupied, for a predetermined interval. The override interval shall be configurable for 1 to 1,440 minutes. The local occupancy sensor/switch, or bypass button shall be given priority over a BAS/ATC command.
6. BAS Integration
 - a. The room controllers shall be capable of direct communications with the existing BAS/ATC system via Bacnet SIP open protocol.
 - b. The BAS/ATC shall be interfaced to allow remote monitoring of specified controller outputs and inputs and shall be capable of resetting room temperature set point.

PART 3 - EXECUTION

3.1 MOUNTING HEIGHTS

- A. Mounting height for space sensors and thermostats shall be 44 inches from the finished floor to the centerline of the device. If the designated location of a device places it partially between two finishes, the actual location shall be adjusted to set the device entirely on one finished surface only, but actual height shall not exceed mounting heights indicated or required by codes.

PART 4 - SEQUENCE OF OPERATION

A. Chilled Water Secondary Pump, P-7

1. If building cooling plant is enabled, the return isolation valve CV-1 shall open and modulate to maintain the campus chilled water return temperature setpoint of 55 degrees F (adjustable).
 - a. If the building pressure differential is 2 psi (adj) less than the building chilled water differential setpoint, the chilled water pump P-7 shall be signaled to start and shall speed up and down via its VFD to maintain the building differential pressure. The return isolation valve CV-1 shall be commanded full open.
 - b. If the pressure differential increases to 1 psi (adj) more than the building chilled water differential setpoint, the chilled water pump P-7 shall be signaled to stop.
2. BAS / ATC operator interface graphic shall include:
 - a. Outside air temperature.
 - b. Building differential pressure.
 - c. Return isolation valve position.
 - d. Building cooling water supply temperature.
 - e. Building cooling water return temperature.
 - f. Campus chilled water differential pressure.
 - g. Alarms.
3. Alarms shall be annunciated with an alarm at the operator interface:
 - a. Campus chilled water return temperature more than 2 degrees F (adjustable) beyond setpoint.

B. Preheat Coil Pumps, P-8 & P-9

1. If the outside air temperature is below 38 degrees F (adjustable), the preheat coil pumps shall start and run continuously. The pumps shall run no matter if in the unit is in the occupied or unoccupied mode.

C. Heating Water Pump, P-10

1. A signal from BAS/ATC system shall energize or de-energize each pump. Each pump is controlled via a variable frequency drive.
2. Hot water for heating or VAV box heating coils shall constantly be available regardless of outside air temperature.
3. The duty hot water pump shall be energized and run continuously. A sensor referencing pressure differential between the hot water supply and return mains located two-thirds of the distance to the furthest coil shall be input to the BAS/ATC system. The hydronic system balancer shall determine the minimum pressure setting required for full water flow to the most remote coil. The variable frequency drive shall modulate to maintain the minimum required pressure differential.
4. The pumps shall automatically operate in a duty-standby sequence to maintain equal operating hours. The duty-standby operation shall be switched every 168 hours (adj).
5. Upon a failure of the duty pump as determined by a differential pressure switch, the standby pump shall be energized after a time delay. Provide an alarm message, through the operator interface, when flow is not verified. Remove the run command of the failed pump and require a software reset to return the pump to normal service.

- D. Air Handling Unit, AHU-1
 - 1. x
- E. Air Handling Unit, AHU-2
 - 1. x
- F. Variable Air Volume Boxes
 - 1. Occupied Cycle: On a fall in space temperature below setpoint as sensed by a space temperature sensor, the VAV box damper shall modulate toward its minimum position. Upon reaching damper minimum position, and on a continued fall in space temperature below the heating set point, the VAV box heating coil control valve shall modulate open and the box damper shall move to its heating position. On a rise in space temperature, the reverse shall occur.
 - 2. Unoccupied Cycle: VAV box damper and heating coil control valve shall operate to maintain unoccupied space temperature set point.
- G. Baseboard Radiation
 - 1. Radiation shall be provided with a 2-way control valve. Upon a drop in space temperature below temperature setpoint (70 degrees adjustable), as sensed by a temperature sensor, the 2-way valve shall open. Upon a rise in space temperature above setpoint, the reverse shall occur.
 - 2. Radiation shall be disabled if the associated air handling unit serving the space enters Cooling Mode.
 - 3. Radiation shall be first stage of heating in rooms with sensors controlling VAV reheat coils / duct heating coils.
 - 4. Alarms shall be annunciated with an audible and visual alarm at the operator interface:
 - a. Low space temperature (less than 50 degrees F, adjustable).
- H. Fan Coil Unit, FC-1
 - 1. The unit shall be indexed to occupied/unoccupied from commands from the BAS/ATC system. In the event of loss of communication with the building automation system, the unit controller shall automatically transfer control setpoints for heating, cooling and night setback to the default values programmed at the controller.
 - 2. Heating Cycles
 - a. Occupied: The fan is turned on. As the room temperature begins to drop, the unit's PID loop shall begin to open the unit's hot water valve in order to optimally arrive at the space's adjustable heating set point. If the room temperature begins to rise, the Unit's PID loop shall begin to close the unit's hot water valve in order to optimally arrive at the space's adjustable heating set point. If the unit's heating valve is modulated fully closed and the space temperature is above the space cooling setpoint then the unit shall be indexed to the cooling mode.
 - b. Unoccupied: When the outside air temperature below 65 degrees F and the unit is indexed to unoccupied heating mode, the heating valve is indexed to the full open position and the fan is turned off. Upon a drop in the space temperature to the night setback setpoint the fan is cycled on until night setback setpoint is achieved.
 - 3. Cooling Cycle

- a. Occupied: The fan is turned on and the chilled water control valve shall modulate to maintain the spaces cooling setpoint. If the space temperature is below heating setpoint with the chilled water valve closed, the unit shall be indexed to occupied heating.
 - b. Unoccupied: When the outside air temperature is above 75 degrees F and the unit is indexed to the unoccupied cooling mode, the cooling valve shall be modulated fully closed and unit fan is turned off. On a rise in space temperature above the setup temperature, the unit fan shall be turned on and the cooling valve shall be fully opened. When the space set-up temperature is satisfied, the unit fan shall be de-energized and the valve shall be modulated fully closed.
4. The unit's auxiliary drain pan shall be provided with a high level alarm sensor. On a high water level alarm, the units fan shall be turned off, the chilled water valve shall be closed, and an alarm shall be reported to the operator interface.
 5. Upon a fall in supply air temperature below 40 degrees F (adjustable,) as sensed by a duct mounted temperature sensor, an alarm shall be reported to the owner's head end terminal.
 6. Upon failure of the supply air fan, (as sensed by a current sensor,) an alarm shall be reported to the owner's head end terminal.
- I. Mechanical Room Exhaust Fan, F-4
1. On a rise in temperature above setpoint of 85 degrees F (adjustable) as sensed by the associated space temperature sensor the fan shall be energized. On a drop in temperature below setpoint the fan shall be de-energized. The associated make-up air damper and exhaust air damper shall be wired to the fan starter to open when the fan is energized.
- J. Mechanical Room Unit Heater, UH-1
1. Upon a drop in space temperature below setpoint of 65 degrees F (adjustable) as sensed by a unit mounted temperature sensor, the hot water control valve shall open and the associated fan shall be energized. Upon a rise in space temperature above setpoint, the reverse shall occur.
- K. Wall Insert Heaters, WIH-1
1. Upon a drop in space temperature below setpoint of 70 degrees F(adjustable) as sensed by a unit mounted temperature sensor, the hot water control valve shall open and the associated fan shall be energized. Upon a rise in space temperature above setpoint, the reverse shall occur.
- L. Perimeter Heat Convectors, CONV-1 & CONV-2
1. Upon a drop in space temperature below setpoint of 65 degrees F (adjustable) as sensed by a space temperature sensor, the hot water control valve shall open. Upon a rise in space temperature above setpoint, the reverse shall occur.
- M. Exhaust Fan for Existing Fume Hood in Engineering Lab, Relocated
1. Upon activation of the hood mounted switch, the fan shall energize, the associated motor operated damper shall open, the associated Lab Exhaust Valve shall close to the indicated position, and the AHU exhaust fan shall reduce speed through its associated variable frequency drive.
BAS/ATC shall indicate at the operator interface that the fan is operational. Upon deactivation of the hood mounted switch, the reverse shall occur.

- N. Exhaust Fan for Fume Hood, F-1
1. Upon activation of the hood mounted switch, the fan shall energize, the associated motor operated damper shall open, the associated Lab Exhaust Valve shall close to the indicated position, and the AHU exhaust fan shall reduce speed through its associated variable frequency drive. BAS/ATC shall indicate at the operator interface that the fan is operational. Upon deactivation of the hood mounted switch, the reverse shall occur.
- O. Paint Spray Booth Exhaust Fan
1. Upon activation of the booth mounted switch, the fan shall energize, the associated motor operated damper shall open, the associated Lab Exhaust Valve shall close to the indicated position, and the AHU exhaust fan shall reduce speed through its associated variable frequency drive. Refer to AHU sequence above and airflow schedule on drawings for fan and LEV sequence. BAS/ATC shall indicate at the operator interface that fan is operational. Upon deactivation of the booth mounted switch, the reverse shall occur.
- P. Exhaust Fan for Range Hood, F-2
1. Upon activation of the hood mounted switch or hood mounted heat sensor, the fan shall energize, the associated motor operated damper shall open, the associated Lab Exhaust Valve shall close to the indicated position, and the AHU exhaust fan shall reduce speed through its associated variable frequency drive. BAS/ATC shall indicate at the operator interface that the fan is operational. Upon deactivation of the hood mounted switch, the reverse shall occur.
- Q. Exhaust Fan for Slot Hood, F-3
1. Upon activation of the wall mounted switch, the fan shall energize, the associated motor operated damper shall open, the associated Lab Exhaust Valve shall close to the indicated position, and the AHU exhaust fan shall reduce speed through its associated variable frequency drive. BAS/ATC shall indicate at the operator interface that the fan is operational. Upon deactivation of the wall mounted switch, reverse shall occur. The wall switch will be provided by EC.
- R. Exhaust Fan for Flexible Arm in Printmaking, Relocated
1. Upon activation of the wall mounted switch, the fan shall energize, the associated motor operated damper shall open, the associated Lab Exhaust Valve shall close to the indicated position, and the AHU exhaust fan shall reduce speed through its associated variable frequency drive.
BAS/ATC shall indicate at the operator interface that fan is operational. Upon deactivation of the wall mounted switch, the reverse shall occur. The wall switch will be provided by EC.
- S. Weld Smoke Collectors WSC-1, WSC-2 and WSC-3
1. Upon activation of the wall mounted switch, the collector fan shall energize. Upon deactivation of the wall mounted switch, the reverse shall occur. The wall switch shall be provided by EC.
- T. Electric Heat Trace:
1. Electric heat trace shall operate under manufacturer's line voltage thermostat to maintain pipe temperature above freezing. Upon an outside air temperature below 40 degrees F, the BAS/ATC shall monitor the operation of the heat trace with current sensing relay. If the heat trace is not operating, send an alarm to the BAS/ATC operator interface.

U. Exterior Site Lighting:

1. The BAS/ATC system shall provide user adjustable control schedules to provide an Occupied/Unoccupied signal to a digital input/output relay device, located in Mechanical 076, for control of building site lighting via a digital lighting control system. Lighting control system and all devices will be furnished and installed by EC. All control wiring between the BAS/ATC panel and the input/output relay shall be by Mechanical Contractor. Exterior lighting shall be controlled either by user adjustable schedule on the BAS/ATC system, or via photocell.

V. Domestic Hot Water Recirculation Pump, CP-1

1. The BAS/ATC system shall energize the respective domestic hot water recirculation pumps during occupied hours (adjustable by user). Pumps shall be de-energized during the unoccupied hours (adjustable by user). Refer to the plumbing documents for the pump location

****END OF SECTION****

SECTION 160220
TESTING, ADJUSTING AND BALANCING OF HVAC SYSTEM

PART 1 - GENERAL

1.1 WORK INCLUDED

- A. The Work of this Section shall include the labor, materials, and equipment required for testing and balancing the water systems and air distribution systems.
- B. Contractor shall procure the services of an independent air balance and testing agency to be approved by the Owner.

1.2 DEFINITIONS

- A. AABC: Associated Air Balance Council.
- B. NEBB: National Environmental Balancing Bureau.
- C. TAB: Testing, adjusting, and balancing.
- D. TABB: Testing, Adjusting, and Balancing Bureau.

1.3 SUBMITTALS

- A. Qualification Data: Within 30 days of Contractor's Notice to Proceed, submit documentation that the TAB contractor and this Project's TAB team members meet the qualifications specified in "Quality Assurance" Article.
- B. Qualifications: The testing, adjusting, and balancing (TAB) agency shall submit a company resume listing personnel and project experience in air and hydronic system balancing and a copy of the agency's test and balance engineer (TBE) certificate.
- C. Field reports indicating deficiencies in systems that would prevent proper testing, adjusting, and balancing of systems and equipment to achieve specified performance.
- D. Certified TAB reports, including instrument calibration reports, within thirty days after substantial completion of the project. Test and balance reports shall include the following documentation in addition to the documentation required in Part 3 - Execution:
 - 1. Report table of contents.
 - 2. Each individual final Reporting Form submitted must bear the signature of the person who recorded the data and the signature of the testing and balancing supervisor of the performing firm.
 - 3. If more than one certified firm performs the TAB work, all final reports shall be submitted by that certified firm having managerial responsibility.

4. Identification of all types of instruments used and their last dates of calibration shall be submitted with the final report.
5. The final test report shall include appropriate reference to all problems regarding the system(s) encountered prior to, during and after testing and what action taken to correct the problem(s), including noise and vibration.
6. Prints (reduced in size) or sketches showing the following for easy reference to report data:
 - a. Supply, return, and exhaust air outlet locations.
 - b. Air system(s) schematic(s) including terminal numbers and traverse locations.
 - c. Hydronic system(s) schematic(s) including flow station locations.
 - d. An approved copy of the balancing report shall be included in the Operating and Maintenance Manual submittal.

1.4 QUALITY ASSURANCE

- A. TAB Contractor Qualifications: Engage a TAB entity certified by AABC, NEBB, or TABB.
 1. TAB Field Supervisor: Employee of the TAB contractor and certified by AABC, NEBB or TABB.
 2. TAB Technician: Employee of the TAB contractor and who is certified by AABC, NEBB or TABB as a TAB technician.
- B. TAB Report Forms: Use standard TAB contractor's forms approved by Owner.
- C. Instrumentation Type, Quantity, Accuracy, and Calibration: As described in ASHRAE 111, Section 5, "Instrumentation."

1.5 PREPARATION AND COORDINATION

- A. Shop drawings, submittal data, up-to-date revisions, change orders, and other data required for planning, preparation, and execution of the TAB work shall be provided to the TAB agency no later than 30 days prior to the start of TAB work.
- B. System installation and equipment startup shall be complete prior to the TAB agency's being notified to begin.
- C. Provide seven days' advance notice for each test. Include scheduled test dates and times.
- D. Perform TAB after leakage and pressure tests on air and water distribution systems have been satisfactorily completed.

1.6 PROJECT CONDITIONS

- A. Heating, ventilating, and air conditioning equipment shall be completely installed and in continuous operation as required to accomplish the test and balance work specified.
- B. TAB shall be performed when outside conditions approximate design conditions indicated for

heating and cooling functions.

- C. Full Owner Occupancy: Owner will occupy the site and existing building during entire TAB period. Cooperate with Owner during TAB operations to minimize conflicts with Owner's operations.

PART 2 - PRODUCTS

2.1 INSTRUMENTS

- A. Instruments used for testing and balancing of systems shall have been calibrated within a period of six months prior to balancing. Test and balance reports shall include a letter of certification listing instrumentation used and last date of calibration.

PART 3 - EXECUTION

3.1 AIR SYSTEMS

A. Preliminary

- 1. Identify and list size, type, and manufacturer of all equipment to be tested, including air terminals. Use manufacturers' ratings for all equipment to make required calculations except where field tests show ratings to be impractical.

B. Air Handlers and Fans

- 1. Provide accessory components for motor drives, or replace complete drive package, whenever factory furnished drives on mechanical equipment do not provide design air flows.
- 2. Record equipment manufacturer, model and serial number.
- 3. Test and adjust fan RPM to design requirements.
- 4. Test and record motor voltage and running amperes including motor nameplate data, and starter heater ratings.
- 5. Make pitot tube traverse of main supply, exhaust and return ducts, determine CFM at fans, and adjust fans to design.
- 6. Test and record system static pressure, suction and discharge.
- 7. Test and adjust system for design outside air, CFM.
- 8. Test and adjust system for design recirculated air, CFM.
- 9. Test and record heating apparatus entering air temperatures, dry bulb.
- 10. Test and record cooling apparatus entering air temperatures, dry bulb and wet bulb.
- 11. Test and record heating apparatus leaving air temperatures, dry bulb.
- 12. Test and record cooling apparatus leaving air temperatures, dry bulb and wet bulb.

- C. Distribution: Adjust zones or branch ducts to proper design CFM, supply and return.
- D. Air terminals
 - 1. Identify each air terminal from reports as to location and determine required flow reading.
 - 2. Test and adjust each air terminal to within 10 percent of design requirements.
 - 3. Adjust flow patterns from air terminal units to minimize drafts to extent design and equipment allows.
- E. Verification
 - 1. Prepare summation of readings of observed CFM for each system, compare with required CFM, and verify that duct losses are within an acceptable range.
 - 2. Verify design CFM at fans as described above.

3.2 HYDRONIC SYSTEMS

- A. Preliminary
 - 1. List all mechanical specifications of tested equipment and verify against contract documents.
 - 2. Open all line valves to full open position, close coil bypass stop valves then set mixing control valve to full coil flow.
 - 3. For each pump: Verify rotation, test and record pump shutoff head, and test and record pump wide open head.
 - 4. Verify proper water level in expansion tanks and in the system.
 - 5. Verify that air vents in high points of water systems are installed and operating freely.
- B. Central Equipment
 - 1. Record equipment manufacturer, model and serial number.
 - 2. Set chilled water and hot water pumps to proper flow quantity.
 - 3. Adjust flow of chilled water through existing chiller to design value.
 - 4. Adjust flow of hot water through existing boilers to design quantity.
 - 5. Observe leaving water temperatures and return water temperatures at existing chiller and boilers. Reset to correct design temperatures.
 - 6. Record pump operating suction and discharge pressures, determine final dynamic head.
- C. Distribution
 - 1. Balance flow of each chilled water coil and hot water coil.
- D. Terminal Units
 - 1. Upon completion of flow readings and adjustments at coil, mark all settings and record inlet water and leaving water temperatures.

2. Observe pressure drop through coil at set flow rate on call for full cooling and for full heating.
3. Set valve in bypass to match coil flow pressure drop on full bypass.

E. Verification

1. Record rated and actual running amperage for each pump motor.
2. Record total dynamic head for each pump.

3.3 BUILDING AUTOMATION SYSTEM

- A. In cooperation with the building automation system manufacturer's representative, set and adjust automatically operated devices to achieve required sequence of operations. Refer to Section 160210, Building Automation System.
- B. Testing organization shall verify all controls for proper calibration, set points and proper operation and list those controls requiring adjustment by building automation system installer.

****END OF SECTION****

**SECTION 160230
WIRING OF HVAC EQUIPMENT**

PART 1 - GENERAL

1.1 WORK INCLUDED

- A. The Work of this Section shall include the power and control wiring of HVAC equipment. It shall not include control wiring specifically detailed as part of the automatic temperature control system specified in Section 239010, Building Automation System.

PART 2 - PRODUCTS

2.1 MATERIALS

- A. HVAC Contractor shall provide equipment with controls, starters and related items as specified in various Sections of Division 23.
- B. Where HVAC equipment is specified without starters or controllers, Electrical Contractor shall provide same as specified herein.
- C. Electrical Contractor shall provide all power wiring unless specifically noted otherwise.
- D. HVAC Contractor shall furnish and install all control wiring unless specifically noted otherwise.

PART 3 - EXECUTION

3.1 INSTALLATION

- A. Mechanical equipment shall be wired in accordance with the following schedule:

Key:

<input type="checkbox"/>	Item furnished by.....
<input type="checkbox"/>	Item installed by....
<input type="checkbox"/>	Item wired by.....

the respective trade according to the following designations:

H = HVAC Contractor
E = Electrical Contractor
O = Owner

HVAC Equipment Wiring Schedule

Equipment	Disconnect Means					Controllers					Control Devices						
	Remote Disconnect Switch	Integral Disconnect Switch	Wall Switch	Cord & Plug		Magnetic Motor Str	Combination Motor Str	Manual Motor Str	VFD with Disconnect	Contactor	Line Voltage Stat	Low Voltage Stat	Aquastat	Duct Smoke Detector	Control Panel	Flow/Press/Level Switch	BAS/ATC Control
Air Handling Unit Fans, AHU-1 & AHU-2	H								H					E			H
	H								H					H			H
	E								E					E			H
Air Handling Unit Lights, AHU-1 & AHU-2	H		H														
	H		H														
	E		E														
Pumps, P-7 & P-10	H								H								H
	H								H								H
	E								E								H
Pumps, P-8 & P-9	H						E										H
	H						E										H
	E						E										H
Fan, F-1 Fume Hood	H		H	H			E										H
	H		H	H			E										H
	E		E	E			E										H
Fan, F-2 Range Hood	H		H	H													H
	H		H	H													H
	E		E	E													H

HVAC Equipment Wiring Schedule

Equipment	Disconnect Means					Controllers					Control Devices						
	Remote Disconnect Switch	Integral Disconnect Switch	Wall Switch	Cord & Plug		Magnetic Motor Str	Combination Motor Str	Manual Motor Str	VFD with Disconnect	Contactor	Line Voltage Stat	Low Voltage Stat	Aquastat	Duct Smoke Detector	Control Panel	Flow/Press/Level Switch	BAS/ATC Control
Fan, F-3 Slot Hood	H		H	E													
	H		H	E													
	E		E	E													
Fan, F4	H		H														
	H		H														
	E		E														
Unit Heater, UH-1	H		H														H
	H		H														H
	E		E														H
Wall Insert Heaters, WIH-1 & WIH-2	H		H														H
	H		H														H
	E		E														H
Weld Smoke Collectors, WSC-1, WSC-2 & WSC-3	H			E			E										
	H			E			E										
	E			E			E										
Fan Coil Unit, FC-1	H		H														H
	H		H														H
	E		E														H

HVAC Equipment Wiring Schedule																	
Equipment	Disconnect Means					Controllers					Control Devices						
	Remote Disconnect Switch	Integral Disconnect Switch	Wall Switch	Cord & Plug		Magnetic Motor Str	Combination Motor Str	Manual Motor Str	VFD with Disconnect	Contactor	Line Voltage Stat	Low Voltage Stat	Aquastat	Duct Smoke Detector	Control Panel	Flow/Press/Level Switch	BAS/ATC Control
Paint Spray Booth	H		H				E										H
	H		H				E										H
	E		E				E										H
Relocated Fume Hood Fan	O		O														H
	H		H														H
	E		E														H
Relocated Flexible Exhaust Hood Fan	O		E	E													
	H		E	E													
	E		E	E													

- B. Contractor responsible for wiring of an item shall be responsible for furnishing and installing all wiring for that item and making all connections associated with this wiring.
- C. Electrical Contractor shall furnish and install wiring from duct smoke detector to fire alarm panel. Mechanical Contractor shall furnish and install wiring from normally open auxiliary contact on duct smoke detector to control circuitry for shut down of equipment if duct smoke detector is activated.

END OF SECTION

SECTION 160240

CHEMICAL WATER TREATMENT

PART 1 - GENERAL

1.1 SECTION INCLUDES

- A. Cleaning of closed loop piping systems
- B. Chemical feeder equipment
- C. Chemical treatment
- D. Filter/feeder

1.2 REFERENCES

- A. NFPA 70 - National electrical code.

1.3 SUBMITTALS

- A. Submit in accordance with provisions of section 230010.
- B. Shop drawings: Indicate system schematic, equipment locations, and controls schematics, electrical characteristics and connection requirements.
- C. Product data: Provide chemical treatment materials, chemicals, and equipment including electrical characteristics and connection requirements.

1.4 REGULATORY REQUIREMENTS

- A. Conform to applicable code for addition of non-potable chemicals to building mechanical systems, and for to public sewage systems.
- B. Products requiring electrical connection: Listed and classified by UL as suitable for the purpose specified and indicated.

1.5 MAINTENANCE SERVICE

- A. Furnish service and maintenance of treatment systems for one year from date of substantial completion.
- B. Provide quarterly technical service visits to perform field inspections and make water analysis on site. Detail findings in writing on proper practices, chemical treating requirements, and corrective actions needed. Submit two copies of field service report after each visit.

1.6 PROCEDURE

- A. If this system is to be tied into an existing system than some form of lock-out valve should be utilized until the new system is proper commissioned before being allowed to be tied into the existing system. This will prevent containments from entering the existing system.

PART 2 - PRODUCTS

2.1 MANUFACTURER

- A. Water Treatment By Design, Mark Coldren, CWT (717) 773-5866- no substitutions

2.2 EQUIPMENT

- A. Five gallon filter/feeder with legs, model Vector FA-1000AL VF-1000HT250
- B. One case of twelve filter cartridges shall be provided: 3 ten micron, 3 five micron, and 6 one micron filters.

2.3 SYSTEM PREPARATION

- A. Water flush applies to the following systems:
 - 1. Closed Loop Water: Dump and refilled the closed loop system to remove existing raw contaminants and suspended solids. This procedure should be done twice.
- C. Refill the system with water and allow for 10 percent by volume of pre-cleaner Formula 6960 for the removal of scale, glycol oils and other extraneous materials. Add the required amount of cleaner and circulate for 24 hour.
- E. Flush the system after the required circulation period as quickly as possible, this will prevent settling of foulants. Run circulating pumps and flush with clean water until the discharge water is clear and the pH is within 0.5 of the incoming makeup water, and the conductivity of the loop water is within 25 micro ohms of the make-up water conductivity. Once the system water is clear, remove, clean and replace all strainers.
- F. Immediately add Formula 6204 to obtain a residual of 1000-15.300 ppm. Allow time for the inhibitor to circulate and retest to ensure that this level of inhibitor has been achieved within the system.
- H. Service on a quarterly basis making necessary adjustments to maintain the residual with the recommended operational control ranges of 600 to 1200 ppm. as Nitrite.

PART 3 - EXECUTION

3.1 INSTALLATION

- A. Install in accordance with manufacturer's instructions.
- B. Provide one filter/feeder on each system. Filter feeder shall be plumbed across the common headers for the discharge and return lines.

3.2 WATER TREATMENT PROGRAM

- A. The Water Treatment Company shall provide:
 - 1. Installation and system start-up procedure recommendations
 - 2. Pre-operation system cleanout procedure supervision
 - 3. Training of operating personnel on proper feeding and control techniques
 - 4. Quarterly field service and consultation meetings
 - 5. Any necessary log sheets and record forms
 - 6. Any required laboratory and technical assistance
- B. All services shall be provided by a qualified, full-time representative of the Water Treatment Company.

END OF SECTION 230545

**SECTION 180010
GENERAL PROVISIONS – ELECTRICAL**

PART 1 - GENERAL

1.1 WORK INCLUDED

- A. Electrical Work shall consist of labor, materials, and equipment required for furnishing and installing the electrical system.
- B. Electrical Work shall include the following Specification Sections:

1. Specifications:

Section 180010	General Provisions – Electrical
Section 180020	Basic Materials
Section 180030	Wire and Cable, 600 Volts and Below
Section 180040	Raceway and Fittings
Section 180050	Boxes
Section 180060	Wiring Devices
Section 180070	Grounding Systems
Section 180080	Electrical Service
Section 180100	Panelboards
Section 180110	Disconnect Switches
Section 180120	Overcurrent Protective Devices
Section 180130	Dry Type Transformers
Section 180140	Lightning Protection System
Section 180150	Lighting
Section 180170	Lighting Controls
Section 180180	Special Systems
Section 180190	Controls and Instrumentation
Section 180120	Wiring of Mechanical Equipment

1.2 REFERENCE STANDARDS

- A. Portions or all of certain recognized industry or association standard referred to herein as being a requirement of these Specifications shall be considered as binding as though reproduced in full herein. Unless otherwise stated the reference standard shall be the standard which is current as of the date of issuance of these Specifications. Reference may be made to standards either by full name or for the sake of brevity by letter designation only. The following is a list of the most commonly used standards, but is not all inclusive for these Specifications:

ADA Americans with Disabilities Act

AES	Audio Engineering Society
AIA	American Institute of Architects ANSI American National Standards Institute
ASTM	American Society for Testing and Materials
BICSI	Building Industry Consulting Services International
EIA	Electronics Industry Association
FM	Factory Mutual Engineering Corporation
ICC	International Code Council
IEEE	Institute of Electrical & Electronics Engineers
IES	Illuminating Engineering Society
ICEA	Insulated Cable Engineers Association
NEC	National Electrical Code
NECA	National Electrical Contractors Association
NEMA	National Electrical Manufacturers Association
NETA	National Electrical Testing Association
NESC	National Electric Safety Code NFPA National Fire Protection Association
OSHA	Occupational Safety and Health Administration
TIA	Telecommunications Industry Association
UL	Underwriters Laboratories, Inc.

1.3 PERMITS AND INSPECTIONS

- A. Secure all permits and inspections required by applicable authorities and pay all costs in connection with the Work.
- B. Schedule all inspections required by applicable authorities. Certificates shall be in triplicate and shall be delivered to Owner.
- C. Electrical inspection shall be made by the Code Official or Code Administrator as directed by the municipality in which the work is being performed.

1.4 CODES AND STANDARDS

- A. Electrical Work is subject to provisions of the Pennsylvania Uniform Construction Code and has been designed to be in compliance with this code. Design aspect of the Project shall not be altered regarding building envelope or selection of electrical distribution and illumination systems and equipment. Supplemental data published by equipment and system manufacturers to substantiate energy conservation efficiencies throughout the Project shall be furnished at request of Owner.
- B. Work shall meet requirements of the National Electrical Code and all federal, state, and municipal authority's laws, rules and regulations applicable to the Work.
- C. Where applicable, materials and equipment shall bear the label of approval of Underwriters Laboratories, Inc.
- D. Reference to codes and standards listed herein shall constitute minimum acceptable requirements.
- E. If Contractor, during the course of work, observes the existence of hazardous materials in the structure or on the project site, Contractor shall promptly notify Owner. Contractor shall not perform any work pertinent to the hazardous material prior to receipt of special instructions from the Owner. "Hazardous materials", for the purpose of this Specification, are defined as asbestos, PCB's, petroleum, radioactive material, or hazardous waste substances.

1.5 SUBSTITUTIONS

- A. Specifications for each piece of equipment and each item of material are written around a product of a specific base manufacturer. This base manufacturer is the basis of design, dimensions and details. The base manufacturer's name and model information are included with the product description as the first named manufacturer under the heading "Acceptable Manufacturer".
- B. "Substitution" manufacturers are defined as any manufacturer other than the one used as the basis of design. "Substitution" manufacturers will be permitted, in accordance with the Owner's requirements.
- C. Manufacturers named in the product description, in addition to the base manufacturer, are "substitution" manufacturers, have been determined to be manufacturers capable of manufacturing products similar to the base manufacturer and these manufacturers are acceptable "substitution" manufacturers to the base manufacturer. Where additional manufacturer's names do not appear with the base manufacturer, the Owner reserves the right to disallow any "substitution" manufacturers. Where the base manufacturer's name is followed by the term "no substitution", no "substitution" manufacturers will be considered.
- D. Naming of specific manufacturers shall not be construed as eliminating products or services of other "substitution" manufacturers having comparable items. Where permitted by these Specifications, and where Contractor desires to use other "substitution" manufacturers, he may

submit a request for approval to use the “substitution” manufacturer.

- E. Products described in Specifications are intended to set a quality level and ensure a workable system. “Substitution” of manufacturers, including those herein named, may be made only after approval of Owner. Contractor shall assume full responsibility for installation and dimensional changes required by the use of all “substitution” manufacturer’s products, including revisions to wiring, controls, piping, structural revisions, etc., and all room or space changes as required due to dimension differences of the “substitution” manufacturer product. Owner approval of “substitution” manufacturer’s products shall be limited to compliance with information given in the Specifications.

1.6 SHOP DRAWINGS AND PRODUCT DATA

- A. Submit shop drawings and product data for approval to Owner. Shop drawings and product data shall have been reviewed and approved (stamped) by Contractor furnishing the equipment. If evidence of this Contractor’s approval does not appear on submittal data, submittals will be returned without review. Following Owner review, submittals not approved or requiring resubmission shall be corrected and resubmitted until satisfactory. Work indicated on shop drawings and product data shall not be executed until submittals have been approved.
- B. Submittals for equipment and material shall indicate room numbers, drawing identification symbols, product type, capacities, accessories, connection sizes, electrical characteristics, wiring diagrams, and installation instructions. Each shop drawing shall have specified items, accessories and options, as applicable to this Project, clearly marked. Catalog numbers, part numbers, etc. on shop drawings will not be reviewed for correctness, Contractor is responsible for verifying correctness of these and that they relate to the options, accessories, features, etc. marked on the shop drawings. Shop drawings not clearly marked as to only that which will be provided for this Project will not be approved.
- C. In as much as it is not the purpose of the submittal process to assure that the Contractor is meeting all the requirements, submittal review by Owner is for conformance with design concept of the Project and general compliance with information given in the construction documents. Approval, corrections and/or comments made as part of the submittal review do not relieve the Contractor of the responsibility from conformance with all applicable codes and laws. Contractor is responsible for dimensions, quantities, and performance requirements to be confirmed and correlated at the job site; for information that pertains solely to the fabrication processes or to techniques of construction; and for all coordination with the Work of all trades. Refer to paragraph entitled “Substitutions” in this section of the specifications.
- D. At the time of each submittal, Contractor shall give Owner specific written notice of such variations, if any, that the Shop Drawing or product submitted may have such notice to be in a written communication separate from the submittal; and, in addition, shall cause a specific notation to be made on each Shop Drawing and sample submitted to Owner for review and approval of each such variation. Owner’s review and approval of Shop Drawings or products shall not relieve Contractor from responsibility for any variation from the requirements unless Contractor has in writing called the Owner’s attention to each such variation at the time of each submittal and Owner has given written notation thereof incorporated in or accompanying the Shop Drawing or product approval; nor will any approval by Owner relieve contractor from responsibility for complying with the requirements of this paragraph.

- E. Shop drawing submittals shall be accompanied by a transmittal sheet with the applicable specification section number and the "name" of the item or items being submitted clearly indicated on the transmittal. All "names" on the transmittal shall match exactly the "names" listed in the specifications for the item being submitted.
- F. The name of the supplier, distributor, subcontractor, etc., who will furnish equipment and items to the Contractor shall appear on the shop drawings when submitted. Shop drawing submittals without supplier's, distributors, subcontractors, etc., name will not be reviewed and will be returned without review.
- G. If Owner is required to review any shop drawing or product data submittal more than two times, a Change Order will be issued to the Contractor for a credit due on the Contract Price to recoup Owner's expenses associated with the multiple reviews.
- H. One complete set of approved shop drawings and product data shall be delivered to Owner at completion of Work. Include lists of manufacturer's parts and part numbers.

1.7 COORDINATION - GENERAL

- A. Provide all labor, materials, and equipment required for completion of the Work of Section 18.
- B. Contractor shall visit the project site to determine actual conditions which will be encountered in completing the Work of this Project.
- C. Coordinate Work of Section 18 with that of other trades so that Work will be installed in the most direct manner and so that interference between conduits, piping, ducts, equipment, and architectural or structural features will be avoided. Work installed in an arbitrary manner without regard for Work of other trades will be rejected in any situation where an undesirable condition or an unfair hardship for other trades, or Owner, results.
- D. Provide sufficient scaffolding and hoist or rig material and equipment into place, or arrange for rigging by others. In any case, rigging or hoisting for all Work of Section 18 shall be at the expense of Contractor.

- E. Provide structural steel members as required for support of equipment and materials furnished under Section 18. Provide all hangers and supports, as specified, detailed, or in accordance with accepted industry standards.
- F. Equipment shall be installed in accordance with equipment manufacturer's installation instructions. Obtain manufacturer's installation instructions prior to roughing-in.
- G. Where equipment is furnished by other trades for installation as Work under Section 18, or where electrical service or utility connection, to equipment installed by others, is indicated as Work of this Division, obtain approved shop drawings and installation instructions from respective contractor prior to roughing-in.
- H. Where equipment is indicated to be furnished as Work of Section 18 for installation by others, or where equipment furnished and installed under Section 18 requires utility connections by others, provide to the respective contractor one copy of an approved shop drawing and installation instructions necessary for execution of his work.
- I. Owner reserves the right to move any outlet or stubbed-up conduit, a distance of twenty-five feet before roughing-in, without additional cost to Owner.
- J. Unless specifically indicated, communication between the mechanical and electrical systems equipment and panels shall be via a dedicated wiring system furnished and installed by the systems installers. These systems shall be separate from all other data communication networks within the building. Contractor may request approval for providing communications on the Owner's building data network. If Owner's written approval is obtained, the system installer shall fully coordinate the necessary data network connections with the Owner, the Owner's technology consultant, and the contractor responsible for installing the building data network system. The systems shall follow the Owner's data network labeling scheme for outlets and jacks, operation protocols, and shall adhere to all network security measures. The system installer shall be responsible for all costs associated with equipment, materials, and labor necessary to furnish and install the communications network including, but not limited to: jacks, wall plates, cables, conduits and boxes, patch panels, patch cords, additional Owner switches and equipment, additional systems equipment, and programming services.

1.8 COORDINATION - NEW CONSTRUCTION

- A. Openings and recesses, including cutting, patching and finishing, necessary for installation of electrical equipment and devices in new construction will be provided by Contractor.
- B. Where conduit is run concealed in concrete masonry unit (block) walls, Contractor shall be responsible for installing his work in cores of block for mason to wall-in as he carries up wall.
- C. Provide concrete foundations and pads for electrical equipment installed under Section 18. Foundations for equipment shall be as specified in subsequent Sections of the Specifications. Inserts and anchor bolts shall be poured into foundation according to equipment manufacturer's instructions. Method of setting, aligning, and anchoring shall be as recommended by equipment manufacturer. Coordinate concrete pad sizes with equipment manufacturer's recommendations.

1.9 COORDINATION - EXISTING CONSTRUCTION

- A. Cut all openings required in existing construction for installation of equipment and material. Perform all cutting, patching, and refinishing as required to match surroundings.
- B. Existing Ceilings: Remove existing ceiling tile where required for installation of electrical Work. Reinstall existing ceiling tiles as Work is completed. All damaged or broken ceiling tile caused by Contractor's workers shall be replaced by Contractor at no cost to Owner.
- C. Utility interruptions and tie-ins shall be coordinated with Owner a minimum of 14 days in advance of Work.

1.10 CONCRETE

- A. Furnish and install concrete for Work of Section 18. Concrete work shall be in accordance with requirements set forth in Section 24.

1.11 EXCAVATION AND BACKFILL

- A. Contractor will perform excavation and backfill required for Work of this Division, inside and outside building.

1.12 PAINTING

- A. Equipment furnished under Section 18 that is pre-painted or pre-finished by manufacturer shall have all nicks, scratches, blemishes, and rust spots cleaned, primed, and refinished prior to final acceptance by Owner.
- B. Painting shall be in accordance with the Section 24.
- C. Paint systems junction boxes and covers in specified color as follows:
 - 1. Emergency: Orange
 - 2. Fire Alarm: Red
 - 3. Telecommunications and Data: Yellow
 - 4. Access Control, Security and Security CCTV: Brown
- D. General Contractor will paint exposed unfinished equipment, conduit, etc., installed under Section 18.

1.13 EXISTING EQUIPMENT

- A. Removal of Existing Equipment and Materials: Electrical equipment and materials shall be removed as Work of Section 18. Items of value as determined by Owner shall be stored on site where directed by Owner. Equipment and material

that Owner does not wish to retain shall be legally disposed of offsite. Do not remove any equipment and materials from the site without Owner's approval.

1.14 DEMOLITION

- A. Only the trade responsible for Work of Section 18 shall perform the electrical demolition work.
- B. Trace the entire circuit of any existing circuit to be partially removed. Before removal, mark, label or tag remaining portions of that circuit for type of circuit (normal, emergency, etc.) and area or items served.
- C. Existing conduit remaining in place may be reused, provided conduit is thoroughly cleaned and tested for continuity before new wire is installed.
- D. Existing conduit remaining in place, and to be reused, shall run in same direction that new conduit would run, if new conduit were installed.
- E. Removed conduit and wire shall not be reused.
- F. If an existing electrical item to be removed is located in the middle of an existing circuit, with other existing items on that circuit to remain, the existing circuit shall be made continuous.
- G. If an existing electrical item to be removed is located on the end of an existing circuit, the existing wire and exposed conduit back to the next active item on that circuit shall be removed.
- H. If an existing electrical item to be removed is the only item on the circuit, the existing wire and exposed conduit shall be removed back to the panelboard and, unless otherwise noted on the Drawings, the existing breaker for that circuit shall become a spare. Existing panel schedule shall be revised.
- I. Where an existing conduit run, or portion of an existing conduit run, to be removed is partially exposed and partially concealed, the exposed portion shall be removed to a concealed point beyond the surface, i.e. a wall, a ceiling, a floor and the surface shall be patched and refinished to match surroundings.
- J. Requirements for existing exposed conduit, as stated above, shall also apply to existing concealed conduit runs located above existing accessible tile ceilings or existing conduit runs that will be above new accessible tile ceilings.
- K. Unless indicated otherwise, where removal of existing wiring, or existing associated wiring, is indicated, Work shall also include removal of all associated raceways.
- L. In area(s) of work (including areas where ceilings will be removed), all existing exposed unused systems cables shall be removed in their entirety (end to end) in accordance with the National Electrical Code. Contractor shall coordinate with Owner. Verify with Owner that cables are unused and obtain Owner's approval to remove cables.

1.15 RECORD DOCUMENTS

- A. Marked up record drawings shall include:
1. The single line diagram of the building electrical distribution system provided under this contract and;
 2. Floor plans indicating location and area served for all distribution.

1.16 OPERATION AND MAINTENANCE MANUALS

- A. One (1) complete hard copies and 1 soft copy/electronic set(s) on compact disc(s) of the operating and maintenance manual labeled as described herein shall be submitted to the Owner for approval in as many 3-ring loose leaf binders as required. The copies shall be submitted a minimum of two weeks prior to any instructions and demonstrations to Owner's personnel.
- B. The manuals shall be typewritten and the information shall be arranged in a logical order for use by the Owner in maintaining the equipment and systems installed on the project.
- C. The manuals shall include, but not be limited to the following:
1. Table of contents.
 2. Materials list with place of purchase.
 3. List of normally replaced items, such as lamps, fuses, etc., indicating style, rating, size, etc., and place of purchase.
 4. Approved copies of submittals, including component wiring diagrams and BAS wiring piping diagrams of all installed systems indicating all connections, color coding, functions, locations, etc. Approved "As-Noted" submittals shall be corrected to incorporate all approval notes prior to inclusion in the manuals.
 5. Installation, servicing, maintenance and operating instructions for all systems and components with place of original purchase, and name, address and phone number of person servicing system.
 6. Manufacturer's guarantees and warranties.
 7. System and equipment start-up, seasonal changeover, and seasonal shut-down with pre-start checklists and precautions.
 8. System and equipment troubleshooting guides.
 9. Reference documents which shall include construction drawings list, record set of drawings list, test and balance records.
 10. Copies of all inspection certificates and approvals from all inspection agencies.

1.17 SPARE PARTS AND EQUIPMENT

- A. Furnish to Owner spare parts and equipment at project closeout in accordance with each respective specification section that requires spare parts and equipment.

1.18 FINAL PAYMENT AND ACCEPTANCE

- A. Upon written notice that Work is complete and installed in accordance with the intent of the Specifications, Electrical Engineer will make a final inspection with Owner and Contractor. If Electrical Engineer determines that Work is incomplete, or it contains deficiencies, Contractor shall immediately take such measures as are necessary to complete Work or remedy such deficiencies.
- B. Obligations of Contractor, when making application for final payment, are contained in various sections of the Specifications, Addenda or modifications. These obligations consist of furnishing instruction, record drawings, printed material, tools and devices, clean-up services, credit, certificates, start-up test reports.
- C. If documentation required does not accompany the final payment application, Electrical Engineer will not accept Work and will advise that final payment is not recommended. Electrical Engineer will indicate in writing the reasons for refusing to recommend final payment.

PART 2 - PRODUCTS

2.1 MATERIALS

- A. All materials and equipment shall be new, without imperfections or blemishes, and shall be protected from the elements prior to installation.

PART 3 - EXECUTION

3.1 INSTALLATION

- A. Work shall be installed by mechanics skilled in the trade involved.
- B. All electrical equipment and materials shall be installed to allow access to and to facilitate service, maintenance, repair, replacement, etc., of components to all equipment furnished and installed under this Division of the specifications, furnished and installed under all other Sections of the specifications, and, where applicable, Owner furnished and installed and Owner's existing equipment.
- C. Conduit, wire, cable, wiring devices, equipment, etc. shall be installed in such a manner as to preserve access to equipment installed under this project and, where applicable, existing equipment.

3.2 CLEANING

- A. Upon completion of Work, remove all dirt, foreign materials, stains, fingerprints, etc., from all parts and equipment.
- B. Remove all construction debris and vacuum interior spaces of all compartmental equipment.
- C. Conduct cleaning and disposal operations to comply with codes, ordinances, regulations and anti-pollution laws.
- D. Work shall be subject to inspection by the Owner.

3.3 PROTECTION FROM DUST AND DEBRIS

- A. During patching, painting, ceiling removal and replacement, working on the ceiling or on things above the ceiling, etc., maintain cloths or suitable building paper covers to protect building surfaces. Protective measures (drop cloths, protective covers, etc.) shall be placed and sealed over all furniture and equipment to keep items clean and protected against dirt, dust and debris from entering furniture and equipment that the Owner has not removed.
- B. Upon completion of work each day when building is occupied, remove all temporary covers, drop cloths and debris and vacuum clean all worked-in areas to eliminate carrying of dirt materials and dirt tracking throughout building during time construction is not proceeding.

3.4 CONSTRUCTION SEQUENCE

- A. Work to be installed through existing building shall be installed at other than normal occupied hours, coordinate installation times with Owner. Contractor shall be responsible for removing and replacing ceilings for installing items above ceilings in these existing areas. All ceilings removed shall be replaced prior to normal occupied hours.

3.5 OPERATING INSTRUCTIONS

- A. Engage qualified instructors to instruct Owner's personnel to adjust, operate, and maintain systems, subsystems, and equipment not part of a system.
- B. Provide instruction at mutually agreed on times. Schedule training with Owner with at least seven days' advance notice.
- C. Instructor shall operate system(s) in order to demonstrate fulfillment of contract requirements and educate Owner's personnel on the following:
 - 1. Basis of system design and operational requirements.
 - 2. Documentation provided in the operating and maintenance manuals.
 - 3. Startup and normal operation instructions.
 - 4. Warning, trouble indications, emergency operation and failure instructions.
 - 5. Adjustments.
 - 6. Inspection and preventative maintenance.
 - 7. Diagnostics and repairs.

3.6 WARRANTIES

- A. Where extended warranties beyond the normal one-year warranty are, as specified herein, to be applied to a particular item of equipment or system, furnish to Owner a description of the warranty along with any required registration and signature of manufacturer's authorized personnel.
- B. Contractor shall be responsible for coordinating with and having the manufacturer administer these warranties for the full extent of time the warranty will be in effect.
- C. Contractor shall be responsible for administering and servicing all extended warranties for the life of each extended warranty at no additional cost to Owner. Owner's responsibility will be for additional costs for parts associated with warranties that are warranted on a pro-rated basis. All labor for administering and servicing the extended warranty, including actual replacement of parts, will be the responsibility of the Contractor for the extended warranty period. All unwarranted shipping and handling costs for parts and equipment will be the responsibility of the Owner

END OF SECTION

SECTION 180020 BASIC MATERIALS

PART 1 - GENERAL

1.1 WORK INCLUDED

- A. The Work of this Section shall consist of the labor, material and equipment required for furnishing and installing basic materials associated with electrical systems. The specific application of these materials shall be as outlined in this Section and subsequent Sections of this Specification, or as indicated on Drawings.

1.2 SUBMITTALS

- A. Submit for approval in accordance with specified submittal procedures:
 - 1. Access Panels
 - 2. Nameplates; Itemized Listings
 - 3. Wall Plate Labels
 - 4. Fire Stop Sealing Systems
 - 5. Danger/Warning Labels
- B. Submit test reports specified herein.

PART 2 - PRODUCTS

2.1 HANGERS AND SUPPORTS

- A. Hangers and supports shall be suitable for intended purpose and, where shown on Drawings, where detailed, or as noted, shall be of the type indicated.
- B. Hangers and supports shall be galvanized finish, or otherwise protected against corrosion, unless noted otherwise.
- C. All fasteners, mounting hardware and materials for supporting electrical items on the exterior shall be type 316 stainless steel.

2.2 ACCESS PANELS

- A. Access Panel Specification
 - 1. Acceptable Manufacturer: Milcor Style DW, or Karp, Krueger, Boico, Acudor.
 - 2. Type: Gypsum wallboard.

3. Construction: 16 gage steel frame, 14 gage steel panel.
4. Concealed spring hinges. Prime coat finish for field painting.
5. Closing Feature: Flush, screwdriver operated lock with steel cam.

B. Access Panel Specification

1. Acceptable Manufacturer: Milcor, or Karp, Acudor.
2. Type: Fire rated.
3. Construction: 16 gage steel frame, 20 gage steel panel.
4. Continuous hinge with stainless steel pin. Automatic panel closer. Factory attached masonry anchors.
5. Closing Feature: Self-latching lock, direct action knurled knob, interior latch release mechanism, or self-latching lock, flush key-operated cylinder lock with two keys, interior release mechanism as directed by Owner.
6. Rating: UL listed 1/2 hour (B-label), temperature rise 30 minutes, 250 degrees F. maximum.

C. Access Panel Specification

1. Acceptable Manufacturer: Milcor Style M, or Karp, Krueger, Boico, Acudor.
2. Type: Masonry, tile, or wood.
3. Construction: 16 gage frame, 14 gage panel. Concealed spring hinges. Prime coat finish for field painting or stainless steel, satin finish, as required.
4. Closing Feature: Flush screwdriver operated lock with steel cam or cylinder lock with two keys as directed by Owner.

2.3 EQUIPMENT BACKBOARDS

A. Plywood

1. Material: 3/4 inch fire resistive plywood, with beveled edges and square cut corners. Plywood shall be type A/C or better with "C" side towards wall.
2. Backboards shall be sized as required for mounting of electrical equipment at specific locations. Anchor backboards securely to building structure.
3. Plywood shall have two coats of white fire retardant paint, both sides.
4. Where used for telecommunications, shall have 'D' rings, spools, etc., as required for installing wiring neat and orderly.

2.4 SLEEVES

- A. Construction: Sleeves shall be constructed of standard weight, galvanized steel pipe, square cut ends with anchoring lugs welded to outside surface of pipe.

- B. Size: Internal diameter of sleeve shall be 2 inch (minimum) larger than outside diameter of conduit or EMT.

2.5 NAMEPLATES

- A. Laminated phenolic, two outer layers of white phenolic and an inner layer of black with engraving depth to the inner layer.
- B. Nameplate and lettering suitably sized for their locations, but not less than 1/4 inch high letters.

2.6 WALL PLATE LABELING

- A. Acceptable Manufacturer: Brady Corporation BradyBondz™ Cat. No. THT-37-430-10, or as approved.
- B. Material: Gloss polyester.
- C. Adhesive: Permanent acrylic with high adhesive and translucent properties.
- D. Size: 1-1/2 inches wide by 1/2 inch high
- E. Color: Clear.
- F. Text: Black, 1/4 inch high, all capital letters. Label text shall be printed using recommended printing procedures and equipment in accordance with label manufacturer's instructions.
- G. Listing: UL Standard 969.

2.7 FIRE STOP SEALING SYSTEMS

- A. Fire Stop Sealing System Specification
 - 1. Acceptable Manufacturer: Nelson Firestop Products CLK Silicone Sealant, or 3M Fire Protection Products, RectorSeal, Specified Technologies (STI), Tremco.
 - 2. Application: Sealing for floor, wall and ceiling conduit and cable penetrations through fire-rated assemblies.
 - 3. Materials: Single component, ready-to-use, water-resistant, flexible elastomeric silicone sealant. Non-sag/gunnable grade for penetrations in vertical surfaces, self-leveling grade for floor applications.
 - 4. Compliance: Fire endurance tested per ASTM E-814 (UL 1479). In addition to compliance as a fire stop, the sealing system shall prevent the spread of smoke or water.
- B. Fire Stop Sealing System Specification
 - 1. Acceptable Manufacturer: RectorSeal Metacaulk "Putty Sticks", or Specified Technologies (STI).

2. Application: Sealing for floor, wall and ceiling conduit and cable penetrations through fire-rated assemblies.
3. Compliance: Fire endurance tested per ASTM E-814 (UL 1479). In addition to compliance as a fire stop, the sealing system shall prevent the spread of smoke or water.

C. Fire Stop Sealing System Specification

1. Acceptable Manufacturer: Specified Technologies (STI) “EZ-Path”, or Wiremold “Flame Stopper”.
2. Applications: Where conduit sleeves are either shown or required through fire-rated assemblies, “EZ-Path” or “Flame Stopper” may be used in lieu of the standard conduit sleeve and sealant/putty.
3. Cable fill as directed by manufacturer.
4. Gang plates, floor plates and retrofit plates furnished and installed as required.
5. Radius control module furnished and installed where vertical cables leave a horizontally mounted sleeve.
6. Compliance: Fire endurance tested per ASTM E-814 (UL 1479). In addition to compliance as a fire stop, the sealing system shall prevent the spread of smoke or water.

2.8 DANGER/WARNING LABELS

- A. Labels, as specified herein, need not be furnished and installed if the item of electrical equipment specified to receive the label is furnished with a label, with similar wording as specified herein, by the manufacturer.
- B. All electrical equipment specified herein can be de-energized.
- C. Danger Labels for Electrical Equipment That Can Be De-energized:
 1. Acceptable Manufacturer: Clarion Safety, part no. H6010/6058.
 2. Material: Premium polyester with clear over-laminate, self-adhering.
 3. Size: Minimum 4 inches wide by 2 inches high.
 4. Place on electrical equipment that can be de-energized for examination, adjustment, servicing, repairing, maintenance, modifying, installing components within, etc.
 5. Minimum arc flash warning label requirements:

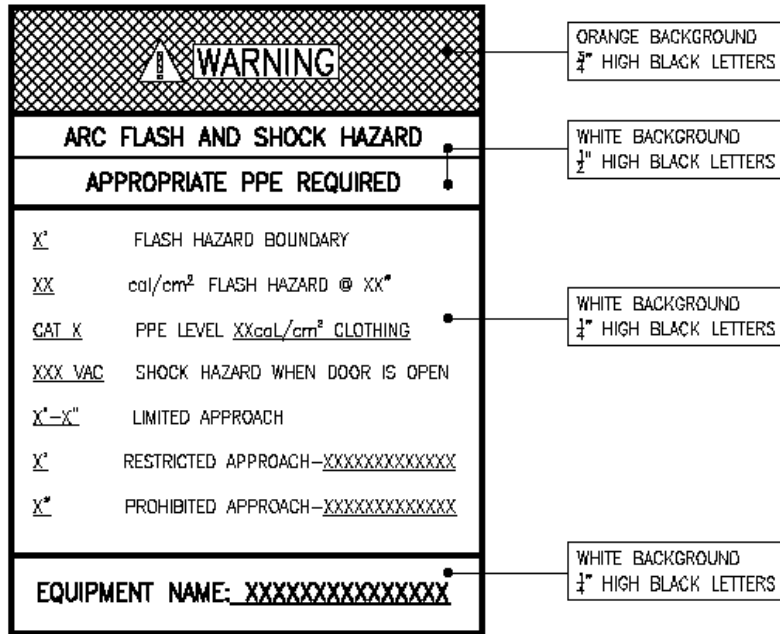

6. Where arc-flash reduction technologies are utilized on service entrance equipment, two labels shall be provided. An orange label shall contain standard operating information; a blue label shall contain information applicable when maintenance mode is activated.

2.9 WIRE AND CABLE TESTING AND CERTIFICATION

A. Safety and Application

1. All wire and cable shall be safety and application tested for its environment and use and shall have the Listed Mark and associated identifiers affixed to the cable outer insulation or, for multi-conductor jacketed cable, affixed to the outer jacket.

B. Performance

1. Wire and cable shall be included in a verification program, be performance tested to the industry and association standards specified herein and shall bear a "verified" mark affixed to the outer insulation or, for multi-conductor jacketed cable, affixed to the outer jacket.

C. Manufacturer's Information

1. Wire and cable shall have the Manufacturer's name, month and year in which cable was manufactured and manufacturer's job number affixed to the outer insulation or, for multi-conductor jacketed cable, affixed to the outer jacket.

- D. All testing shall be performed by an independent testing agency.

PART 3 - EXECUTION

3.1 INSTALLATION

A. General

1. Install products in accordance with manufacturer's instructions.

B. Hangers and Supports

1. Furnish and install suitable hangers and supports for materials and equipment to provide rigid installation. Electrical equipment shall be installed utilizing wood screws on wood, machine screws or lag bolts on masonry or concrete walls and ceilings. Nails will not be permitted.
2. Spring steel clips and clamps will be permitted for hanging conduit 3/4 inch or smaller, above accessible ceilings.
3. Perforated strap hangers will not be permitted. Tie wires will not be permitted.
4. All aluminum components in contact with concrete shall be coated with two coats of zinc chromate primer or bituminous paint to prevent a reaction between the aluminum and the concrete.

C. Access Panels

1. Furnish and install access panels, size as required, but not smaller than 12 inch by 16 inch for access to concealed pull boxes, junction boxes, or similar items where no other means of access is provided.
2. Provide access panels in accordance with the following schedule:

ACCESS PANEL SCHEDULE

Application	Access Panel Spec. No.
Gypsum board (dry wall) finished	2
Fire rated walls and ceilings	3
Masonry, tile, or wood finished	4

D. Equipment Backboards

1. Furnish and install backboards so that equipment will be uniformly arranged on backboard, and connected with wireways and wiretroughs to provide a complete installation.
2. Backboards requiring support shall have 2 inch by 2 inch by 1/4 inch minimum steel angles, welded or bolted.

E. Sleeves

1. Furnish and install for EMT and conduit passing through floors, walls, partitions, slabs, grade beams and foundations.
2. Layout, size and locate sleeves such that they will be set and installed prior to pouring concrete, or when masonry is being constructed. In the event sleeves must be placed after floor, wall, grade beam, etc., has been constructed, submit in writing and obtain approval on location, quantity and proposed method of core drilling and installing.
3. Core drilled openings above grade in solid concrete need not be sleeved but openings shall be clean and neat without cracking or spalling.
4. Sleeves shall be standard weight galvanized steel pipe having square cut ends with anchoring lugs welded on. Horizontal sleeves through walls, grade beams, foundations, and partitions shall be flush with finished wall faces. Vertical sleeves through floors shall extend 2 inches above finished floor and be flush with finished ceiling or underside of floor construction.
5. Size sleeves such that internal diameter is a minimum of 2 inches larger than OD of conduit. Center conduit in sleeves.
6. For conduit passing through floors, slabs, walls, grade beams, or foundations at or below grade and in pits, the sleeves shall be painted or coated with one coat of coal tar pitch paint and the annular space between outside of conduit and inside of sleeve shall be packed with a pliable non-hardening waterproof mastic sealer or a cement base quick-set repair mortar.
7. For conduit passing through walls and floor above grade and with no fire or smoke rating, the annular space between outside of conduit and inside of sleeve or concrete shall be packed tight with batt type fiberglass insulation.
8. For conduit passing through walls and floors above grade with smoke or fire rating of one hour or more, the annular space between outside of conduit and inside of sleeve or concrete shall be sealed with fire stop sealing system.

F. Nameplates

1. Furnish and install a full complement of nameplates for all items of electrical equipment installed as Work of this Division, including motor starters, disconnects, panelboards, individual circuit breakers, motor protective switches, and breakers and switches on distribution panelboards, secondary switchboards, and substations.
2. Install nameplates parallel to equipment lines.
3. Unless noted, nameplates shall be attached with sheet metal screws or epoxy cement. Epoxy cement shall not be used equipment installed outdoors.
4. Coordinate with Owner for nameplate designations. Submit a complete itemized listing of nameplate equipment designations for approval.

G. Wall Plate Labeling

1. Furnish and install labels on all receptacle wall plates identifying the panel and branch circuit breaker number supplying the receptacle (i.e., "LP1-1", "ELP1-1", etc.).
2. The label shall be installed parallel with wall plate outside edges, located on the receptacle center line, and centered between the top of the receptacle and the top of the wall plate. The label placement shall not be placed over a wall plate mounting screw.

3. Prior to attaching label, wall plate surfaces shall be dried, and cleaned of all dirt, paint, oils, grease, or other foreign material that would prevent label adhesion.

H. Fire Stop Sealing System

1. All floor and interior wall penetrations with smoke or fire rating of one hour or more shall be sealed. Refer to architectural drawings for locations of fire rated floor and walls.
2. Outlet boxes, on opposite sides of a fire rated wall and separated by a distance less than 24 inches, shall have fire stop sealants installed, unless the outlet box has been tested and listed for use in the fire rated assembly.
3. Through penetration fire stop sealing systems shall be identified on both sides with permanently mounted, preprinted vinyl labels which include the following information:
 - a. The words “Warning: Through Penetration Firestop System – Do Not Disturb” or similar phrase.
 - b. Manufacturer’s brand name, product type or catalog number
 - c. Testing agency designation and rating
 - d. Installer’s Name
 - e. Installation Date

I. Danger/Warning Labels

1. Danger/warning labels shall be installed on all electrical equipment – switchgear, switchboards, panelboards, transformers, control panels and motor control centers furnished and installed under this contract. The labels shall be located on the exterior of all switchboards, switchgear, transformers, control panels, and motor control centers and on the exterior of control panels and panelboards located in other than finished spaces, one label on each section of the switchgear, switchboard, and motor control center, both front and rear, where rear accessible. For panelboards in finished spaces, the label shall be located inside the panel door, either on the panel front or on the backside of the panel door.

3.2 TESTS

- A. After installation of wiring and apparatus has been completed, electrical conductors shall be tested to insure continuity, proper splicing, freedom from ground (except “made ground” and those required for protection), and insulation resistance in accordance with Underwriters Laboratories requirements. Furnish and employ necessary instruments such as ammeters, volt meters, meggers, etc. Preliminary testing with magnetos will be permitted, but will not be acceptable as final or conclusive test. Submit to Owner three copies of final insulation resistance tests for all feeders rated 100 amps and above.
- B. Equipment and wiring systems not indicated as requiring specific tests shall be tested in actual operation to determine that design functions are obtained and that the required features are provided.
- C. Contractor shall perform all visual, physical, mechanical, etc. inspections on items and equipment as directed by manufactures. Where specifications indicate a “prior-to-start-up” or a specific type of test or tests to be performed, testing shall be performed by an independent testing agency or firm. All testing on electrical equipment or items shall be performed in

accordance with the procedures of the National Electrical Testing Association. Costs for all testing shall be the responsibility of the Contractor and shall be included in the bid.

- D. All test equipment requiring calibration shall be calibrated based on manufacturer's recommendations, shall have been calibrated within the manufacturer's recommended time period, calibration shall be current and there shall be a label on the instrument indicating the most recent calibration date and the name of the firm performing the calibration. Type of instrument used and most recent calibration date shall appear on all submitted test reports.
- E. All submitted test results shall have included a summary of the results of the tests and, where applicable, recommendations for corrective or remedial actions to be taken if the tests results indicate a failed or borderline condition.
- F. Testing shall be scheduled such that the equipment shall be energized immediately after successful completion of the testing.
- G. All equipment or items interconnected or dependent upon other items for operation shall be tested simultaneously to verify and ensure proper operations and functions.
- H. Items, equipment, systems, etc., tested (other than existing items) that result in a failure or borderline condition shall be corrected by the contractor and re-tested until test results are satisfactory at no additional costs to the owner.
- I. Consult with Owner prior to testing and adjusting to determine intended function of equipment, wiring and systems. Perform such tests and make necessary adjustments to ensure that design function is obtained.
- J. Where specific tests are specified herein to be performed on equipment or materials, tests shall be recorded and three copies submitted to Owner. Test records shall properly identify equipment, or system, and indicate test date.

****END OF SECTION****

**SECTION 180030
WIRE AND CABLE, 600 VOLTS AND BELOW**

PART 1 - GENERAL

1.1 WORK INCLUDED

- A. The Work of this Section shall consist of the labor, material and equipment required for furnishing and installing wire and cable, 600 volts and below. The specific application of these materials shall be as outlined in this Section and subsequent Sections of this Specification.

1.2 SUBMITTALS

- A. Submit for approval in accordance with specified submittal procedures:
1. Wire and Cable
 2. Connectors
 3. Wire Markers
 4. Tape

1.3 CABLE TESTING

- A. Wire and cable shall be safety and application tested and shall have this information and the Manufacturer's information affixed to the wire and cable as specified in Section 180020, Basic Materials.

PART 2 - PRODUCTS

2.1 WIRE AND CABLE

- A. Acceptable manufacturers of wire and cable shall be as follows: Aetna, Okonite, South Wire, General Cable, Belden, Amer-Cable, American (AIW), Pyrotenax, Pirelli, Berk-Tek, Kerite.
- B. All wire and cable shall conform to the following:
1. Copper shall not be less than 98 percent conductivity.
 2. Single conductor, unless otherwise indicated.
 3. Color coded.
 4. Marked with classification type, conductor size, and voltage rating, every foot, where applicable.
 5. Minimum Size: #12 AWG, unless otherwise specified.

6. Sizes #8 AWG and larger shall be stranded, sizes #10 AWG and smaller for power and lighting circuits shall be solid conductor, unless otherwise specified.
7. UL listed.
8. Minimum size in flexible metal conduit for final connection to recessed lighting fixtures shall be #14 AWG.
9. Wire and cable shall be manufactured no more than one year prior to installation.
10. Unless noted, insulation for wire and cable used on voltage systems 600 volts and below shall be rated 600 volts.
11. Minimum size for control wiring shall be #14 AWG, except 24 volt and below. All control wiring shall be stranded.

C. Aluminum conductors will not be permitted on this Project.

2.2 WIRE

A. Wire Specification

1. Type THW insulation, UL listed.
2. 600 volt insulation.
3. Ampacity based upon maximum conductor temperature of 75 degrees C. in wet or dry locations, continuous operation.
4. Conform to ASTM B3 for solid conductors and ASTM B8 for stranded conductor.
5. Annealed, uncoated copper conductor.
6. Flame retardant, moisture and heat resistant thermoplastic (PVC) insulation.

B. Wire Specification

1. Type XHHW insulation, UL listed.
2. 600 volt insulation.
3. Ampacity based upon maximum conductor temperature of 75 degrees C. dry locations and 75 degrees C. wet locations, continuous operation.
4. Moisture and heat resistant cross linked polyethylene (XLP) insulation.
5. Conform to applicable NEMA and IPCEA requirements.
6. Conform to ASTM B3 for solid conductors and ASTM B8 for stranded conductors.
7. Soft copper conductor.

C. Wire Specification

1. Type THHN/THWN insulation, UL listed.
2. 600 volt insulation.
3. Ampacity based upon maximum conductor temperature of 75 degrees C. dry and wet locations, continuous operation.

4. Flame retardant, moisture and heat resistant thermoplastic (PVC) insulation with nylon jacket.
5. Conform to applicable NEMA and IPCEA requirements.
6. Conform to ASTM B3 for solid conductors and ASTM B8 for stranded conductors.
7. Soft copper conductor.

2.3 CONNECTORS

A. Connector Specification

1. Acceptable Manufacturer: Buchanan B-cap, or Ideal Wing-nut, 3M Scotchlok.
2. Type: Splice connectors.
3. For insulated wire, 600 volt and under, #8 AWG and smaller.
4. Compression solderless connector.
5. Insulated or non-insulated.
6. UL listed.

B. Connector Specification

1. Acceptable Manufacturer: Anderson, or Thomas & Betts, Penn-Union, Dossert, Burndy, Reliable Electric, Ideal.
2. Type: Splice connectors.
3. For insulated wire, 600 volts and under, #6 AWG and larger.
4. Split bolt pressure connector.
5. Bronze.
6. UL listed.

C. Connector Specification

1. Acceptable Manufacturer: Anderson, or Thomas & Betts, Dossert, Burndy, MAC, 3M, Ideal.
2. Type: Splice connectors.
3. For insulated wire, 600 volts and under, #6 AWG and larger.
4. Compression or crimp connector, short sleeve.
5. Copper.
6. UL listed.

D. Connector Specification

1. Acceptable Manufacturer: Anderson, or Thomas & Betts, Penn-Union, Dossert, Burndy, MAC, 3M, Ideal.

2. Type: Lug connector.
3. For insulated wire, 600 volt and under, #8 AWG and larger.
4. Compression or crimp connector, short sleeve.
5. Copper.
6. UL listed.

E. Connector Specification

1. Acceptable Manufacturer: Penn-Union, or Thomas & Betts, Anderson, Dossert, Burndy, Ideal.
2. Type: Lug connector.
3. For insulated wire, 600 volt and under, #8 AWG and larger.
4. Bolted type pressure connection, hex head or hex socket pressure bolts.
5. Copper.
6. UL listed.

F. Connector Specification

1. Acceptable Manufacturer: Penn-Union Penn Crimp, or Ideal Crimp Terminal, Thomas & Betts Sta-Kon, Burndy Insulug, MAC MiniDent, 3M Scotchlok Terminals.
2. Type: Lug connector.
3. For insulated wire, 600 volt and under, #10 AWG and smaller.
4. Compression or crimp type.
5. Standard barrel, insulated for 600 volts.
6. Ring terminal or flanged or flared block spade terminal.
7. Copper.
8. UL listed.

2.4 WIRE MARKERS

A. Wire Marker Specification

1. Acceptable Manufacturer: Thomas & Betts E-Z-Code, or Ideal, W.H. Brady Co.
2. Cloth or vinyl cloth material.
3. Temperature Range: Minus 40 degrees F. to 250 degrees F.
4. Self-sticking adhesive backing.
5. Clear overcoating for permanent legend protection.

B. Wire Marker Specification

1. Acceptable Manufacturer: Thomas & Betts E-Z-Code, Type WSL, or W.H. Brady Co. Type CAB.
2. Vinyl plastic or vinyl polyester.
3. Temperature Range: to 250 degrees F.
4. Self-sticking adhesive backing.
5. Waterproof, solvent proof.
6. Printing permanently protected.

2.5 TAPE

A. Tape Specification

1. Acceptable Manufacturer: 3M Scotch 33+, or Tomic, Okonite.
2. Type: Tape for insulation 600 volts or less.
3. Vinyl plastic all weather electrical tape.

PART 3 - EXECUTION

3.1 APPLICATION

- A. Unless noted, products and material specified in this Section shall be installed in accordance with the following schedule(s).

WIRE SCHEDULE - BUILDING WIRE	
Application	Wire Spec. No.
Install in raceways, 600 volt and below:	
Feeders	1, 3 or 4
Branch circuit wiring	1, 3 or 4

CONNECTOR SCHEDULE	
Application	Connector Spec. No.
Splice Connectors:	
#8 AWG and smaller	1
#6 AWG and larger	2 or 3
Lug Connectors:	
Connection to motor leads	4 or 6

CONNECTOR SCHEDULE

Application	Connector Spec. No.
Stranded wire connection under head of binding screw or bolt	4 or 6
Connection to equipment bus, or screw or bolt terminals or manufacturer supplied lugs	4, 5, 6

Note: All connectors are for use only on 600 volt or less insulated wire.

3.2 INSTALLATION

A. General

1. Shared neutral conductors for branch circuits will not be permitted. All branch circuit phase conductors shall be paired with a dedicated neutral conductor along their entire length.
2. Wiring shall be installed in raceways. Direct burial cable shall not be used.
3. Exterior of wires shall be color coded where applicable, color coding of wires shall conform to the National Electrical Code.
 - a. Color coding shall clearly indicate the difference between:
 - 1) Phase wires of different voltage systems.
 - 2) Neutral and phase wires of each voltage system.
 - 3) The grounding system wire.
 - b. All equipment grounding conductors shall be green in color. All isolated ground conductors shall be green in color with an over-layed black or yellow stripe.
 - c. In sizes and insulation types where factory applied colors are not available, colored plastic tape in overlapping turns shall be applied at all terminal points and in all points of splicing. Tape shall be applied at minimum intervals of 6 inches along the wire and cables.
 - d. Wire color coding for all voltage systems shall conform to Owner's color coding system if Owner has a color coding system, verify with Owner.
 - e. If Owner does not have a wire color coding system or unless required otherwise by local code authorities, the following color coding scheme shall be used for 120/208 volt system:
120/208 Volt system
Phase A - Black
Phase B - Red
Phase C - Blue
Neutral - Natural Grey or White
 - f. If Owner does not have a wire color coding system or unless required otherwise by local code authorities, the following color coding scheme shall be used for 277/480 volt system:

277/480 Volt system

Phase A - Brown

Phase B - Orange

Phase C - Yellow

Neutral - Natural Grey or White

4. Pull wire into conduit so that insulation will not be damaged. Approved pulling compound shall be used to assist in pulling of 600 volt wire into conduit. Oil or grease will not be permitted. Pulling compound shall be compatible with wire insulation and conduit. Do not exceed manufacturer's recommended maximum pulling tensions.
5. Conductors shall be installed continuous from outlet to outlet, without splicing except within outlet or junction boxes.
6. Noninsulated splices in insulated wire, 600 volts and under shall be factory insulated as follows:
 - a. Rubber and friction tape coated with Scotchkote or similar coating.
 - b. Scotchfil or equivalent electrical putty with Tape Specification No. 1.
 - c. Insulation of splices shall provide same insulation qualities as insulation of wire being spliced.
7. Lugs on motor leads shall be fastened with brass machine bolts, lock washers, and nuts.
8. Stranded wire shall not be placed under the head of a binding screw or bolt. Refer to Part 2 - Products, this Section, for connectors to be used in stranded wire connections under head of binding screw or bolt.
9. Wire shall be identified by use of wire markers at termination points, including outlet boxes, pull boxes, junction boxes, wireways and at locations where wire changes direction within an enclosure.
10. Provide minimum of 6 inches of conductors extended from opening of each outlet box.
11. Wiring in finished area shall be concealed. Wiring serving switch legs, receptacles, and lighting fixtures on concrete masonry unit type walls in areas such as boiler rooms and equipment rooms shall be concealed.
12. Feeder Identification:
 - a. Identify feeders using a two-segment conductor numbering scheme which defines the origin of the conductor and the destination of the conductor. Example: DSA-PA where DSA is the origin, and PA is the destination.
 - b. For conductors with one point of origin and two or more destinations, expand the destination identification number, e.g., PA, PB, etc.
 - c. Make the origin and destination identification the specific names for the equipment. A feeder shall be as defined in the National Electrical Code.
13. Exact routing of conduit and placement of boxes for wiring shall be governed by jobsite conditions.
14. Tighten all screws and terminal bolts using torque wrenches and/or drivers to tighten to the manufacturer, U.L. or code required inch-pound requirements. Re-check tightness of all connections prior to energizing.
15. Terminals, connectors, etc., shall be of an acceptable type for the materials used.

16. Cap all spare conductors with U.L. Listed end caps.
17. Only one conductor shall be installed per terminal or lug, unless terminal or lugs are U.L. Rated for more than one conductor.
18. Exact location, material of construction and thickness of all walls to be chased or cut for installation of wiring shall be verified with Owner before Work is begun.
19. All wiring connections made at or below grade shall be waterproof with UL listed waterproof connectors.

B. Emergency Power System Wiring

1. Wiring for lights and equipment on either emergency only or normal emergency power shall be run in non-flexible metal raceways. This wiring shall be kept independent of all other wiring and equipment and shall not enter the same raceways, boxes, or cabinets with each other or other wiring, except in equipment and devices supplied from two sources.

****END OF SECTION****

SECTION 180040 RACEWAY AND FITTINGS

PART 1 - GENERAL

1.1 WORK INCLUDED

- A. The Work of this Section shall consist of the labor, material and equipment required for the furnishing and installing of raceways and fittings. The specific application of these materials shall be outlined in this Section and subsequent Sections of this Specification.

1.2 SUBMITTALS

- A. Submit for approval in accordance with specified submittal procedures:
 - 1. Raceways and Fittings

PART 2 - PRODUCTS

2.1 RACEWAY AND FITTINGS

- A. Acceptable manufacturers of raceway and fittings shall be as follows:
 - 1. Rigid Metal Conduit (RMC):
 - a. Allied Tube & Conduit
 - b. Wheatland Tube
 - c. Copperweld
 - d. Western Tube
 - 2. Electrical Metallic Tubing (EMT):
 - a. Allied Tube & Conduit
 - b. Wheatland Tube
 - c. Copperweld
 - d. Western Tube
 - 3. Polyvinyl Chloride (PVC) - Schedule 40:
 - a. Carlon
 - b. Scepter/Canron
 - c. Allied Tube & Conduit
 - 4. Flexible Metal Conduit:
 - a. American Flex Conduit
 - b. Alflex
 - c. International Metal Hose
 - d. Electri-Flex
 - 5. Liquid Tight Flexible Metal Conduit
 - a. Anaconda Type UA

- b. Electri-Flex Type LA
- c. Flexi-Guard

2.2 RACEWAY SPECIFICATION

- A. Type: Rigid metal conduit (RMC).
- B. Mild steel piping, galvanized inside and outside, thoroughly welded seams, circular in cross section, uniform wall thickness.
- C. Ten foot lengths, reamed and threaded at each end, with coupling on one end and protector on opposite end.
- D. Minimum Size: 3/4 inch
- E. UL Listed.
- F. Threads galvanized after cutting.
- G. ANSI C80.1.
- H. Conduit Couplings
 - 1. Acceptable Manufacturer: Thomas & Betts, Erickson, or Allied Kwik-Couple.
 - 2. Malleable iron.
 - 3. Galvanized.
- I. Bushings
 - 1. Acceptable Manufacturer: Appleton, or Raco, Steel City, Efcor, OZ, Thomas & Betts.
 - 2. Malleable iron.
 - 3. Insulated throat.
 - 4. Ground lug, where required.
 - 5. Screw-on.
- J. Expansion Joints
 - 1. Acceptable Manufacturer: OZ Type EX with BJ bonding jumper, or Appleton.
 - 2. Sleeve with fittings to provide for telescoping of conduits into sleeve; 8 inch movement.
 - 3. Galvanized or cadmium finish.
 - 4. Bonding jumper: Copper.
- K. Conduit Bodies
 - 1. Acceptable Manufacturer: Appleton Unilets, or Crouse Hinds, Pyle National, Killark, OZ, Efcor, Adalet, Neer.

2. Malleable iron or copper-free aluminum.
3. Heavy, threaded hubs.
4. Malleable iron bodies shall be finished with zinc or cadmium, both inside and outside, after all machine work is finished.
5. Screw-on type covers.
6. Neoprene gaskets and stainless steel screws required for damp or wet locations.

L. Conduit Thru-Wall Seal

1. Acceptable Manufacturer: OZ Type WSK.
2. Consist of oversize sleeve and sealing assembly.
3. Sealing ring between the body and oversize sleeve.
4. Galvanized finish.

M. End Bells

1. Acceptable Manufacturer: OZ Type TNS.
2. Malleable iron.
3. Provide smooth rounded pulling surface.
4. Galvanized finish.

N. Conduit Seals

1. Acceptable Manufacturer: Appleton Sealing Unilets, FO or F, Fiber Filler, Apello Sealing Cement, or Crouse Hinds, Pyle National, Killark, Adalet.
2. Malleable iron or copper-free aluminum.
3. For sealing horizontal or vertical runs, as required.
4. Drain fittings, where installed in vertical conduit runs between different temperature zones.
5. Hazardous area classification, as required.
6. Fiber filler and sealing cement.

O. Myers Hubs

1. Stainless Steel, Type 316
2. Grounding
3. Stainless Steel Ground Nut
4. "Vitron (75)" O-Ring

2.3 RACEWAY SPECIFICATION

- A. Type: Electrical metallic tubing (EMT).

- B. High grade mild steel, thoroughly welded seams, circular in cross section, and uniform wall thickness.
- C. Electro-galvanized coating on exterior and enameled or galvanized on interior.
- D. Ten foot lengths; 3/4 inch minimum size.
- E. UL listed.
- F. Fire alarm wiring to be installed in conduits shall be installed in “Fire Alarm EMT”, red galvanized topcoat and “E-Z” pull interior finish. (Allied tube and conduit, or as approved.)
- G. Couplings and Connectors (Compression Type)
 - 1. Acceptable Manufacturer: Appleton, or Efcor, Raco, OZ, Crouse Hinds, Thomas & Betts.
 - 2. Compression type, steel. Die cast will not be accepted.
 - 3. Cadmium finish or galvanized.
 - 4. Rain and concrete tight.
 - 5. Box connectors shall have insulated throat.
- H. Couplings and Connectors (Set Screw)
 - 1. Acceptable Manufacturer: Appleton, or Efcor, Raco, OZ, Crouse Hinds, Thomas & Betts, Steel City, or Allied Kwik-Fit.
 - 2. Set screw type, steel, U.L. listed for grounding. Die cast will not be accepted.
 - 3. Concrete tight.
 - 4. Box connectors shall have insulated throat.
- I. Other Fittings: Same as Raceway Specification No. 1.

2.4 RACEWAY SPECIFICATION

- A. Type: Polyvinyl chloride (PVC), Schedule 40.
- B. Extruded from virgin polyvinyl chloride compound.
- C. Resistant to water, oil, outdoor aging, exposure to sunlight, underground environments, and corrosive atmosphere.
- D. Flame retardant for use above ground, resistant to low temperatures, and resistant to distortion due to heat under conditions likely to be encountered in intended service.
- E. Sufficient strength to withstand abuse, such as impact and crushing during handling, installation, and service.
- F. Ten foot lengths with one coupling furnished for each length.

- G. Minimum Size: 3/4 inch.
- H. Each length clearly and durably marked with manufacturer's name. Markings shall be permanent for PVC used above ground.
- I. PVC conduit shall be UL listed.
- J. Comply with applicable ASTM testing procedures and specifications.
- K. Fittings:
 - 1. Acceptable Manufacturers: Same as PVC conduit manufacturers.
 - 2. Conform to applicable PVC conduit specifications above.

2.5 RACEWAY SPECIFICATION

- A. Type: Flexible metal conduit.
- B. Formed from a continuous length of high grade mild steel strip, zinc coated and shaped into interlocking convolutions.
- C. Minimum Size: 3/4 inch.
- D. UL listed.
- E. Approved for grounding.
- F. Fittings:
 - 1. Acceptable Manufacturer: OZ, or Efcor, Thomas & Betts.
 - 2. Squeeze, 2-screw double clamp, or hinged clamp type.
 - 3. Threadless.
 - 4. Malleable iron, cadmium plated.
 - 5. Approved for grounding.
 - 6. Insulated throat.

2.6 RACEWAY SPECIFICATION

- A. Type: Liquid tight flexible metal conduit.
- B. Made from strong, flexible, galvanized steel core with smooth, abrasion resistant, liquid-tight polyvinyl chloride cover.
- C. Minimum Size: 1/2 inch.
- D. UL listed.

- E. Approved for grounding or built-in, continuous copper ground.
- F. Fittings.
 - 1. Acceptable Manufacturer: Appleton Type STB, or OZ, Efcor, Thomas & Betts, Ideal, Crouse Hinds.
 - 2. Liquid tight.
 - 3. Insulated throat.
 - 4. Steel or malleable iron, cadmium or zinc finish.
 - 5. Approved for grounding.

2.7 RACEWAY SPECIFICATION

- A. Acceptable Manufacturer: Cablofil, Cooper B-Line, Husky, or as approved.
- B. Type: Cable tray, wire basket type
- C. UL Classified and Listed.
- D. Rung Spacing: Open mesh type construction
- E. Loading Depth: 4 inches.
- F. Tray width: As indicated on floor plans.
- G. Furnish and install all connectors and fittings, as required. Where cables drop out of the cable tray, "drop-out" fittings shall be furnished and installed.
- H. Cable tray shall be approved as a ground conductor or ground conductor clamps shall be furnished and installed for each section with appropriate sized ground wire between sections.
- I. The support spacing shall be as required for the working loads and as determined by field conditions. If no load class is indicated for the cable tray rungs, a 'C' class shall be used. A 250 pound concentrated load applied between side rails at mid span shall also be included with a safety factor of 2.0.
- J. Inside corners shall either be manufactured corners or field modified tray sections to maintain inner radius of a minimum of 20 times the outside diameter of the largest cable to be installed in the cable tray. At a minimum, inside corners shall maintain a 24-inch radius unless otherwise approved.
- K. Material: Carbon Steel Wire, welded, bent and surface treated after manufacture.
- L. Finish: Electroplated Zinc Galvanized, thickness of 0.7 mils to 0.8 mils for indoor applications.

PART 3 - EXECUTION

3.1 APPLICATION

- A. Unless noted, products and materials specified shall be installed in accordance with the following schedule(s):

RACEWAY SCHEDULE - EXTERIOR	
Applications	Raceway Spec. No.
Exterior:	
Underground	4
Exposed	1
Final connections to motors	6

RACEWAY SCHEDULE - INTERIOR, UNDER 600 VOLTS	
Applications	Raceway Spec. No.
Interior, 600 volts and under and all systems:	
Concealed in walls & ceilings	2
Exposed within an area between floor and four (4) feet above floor	1
Exposed, at ceiling and above four (4) feet from floor	2
Areas subject to mechanical damage, unless noted	1
Final connections to motors, pipe mounted equipment and equipment exposed to vibration	6
Final connection to recessed lighting fixtures	5

RACEWAY SCHEDULE - IN OR UNDER CONCRETE SLABS	
Applications	Raceway Spec. No.
Underground beneath concrete slabs	1 or 4
In concrete slabs on grade	2 or 4
In concrete slabs above grade	2

3.2 INSTALLATION

A. General

1. Install products in accordance with manufacturer's instructions.
2. Raceway connectors, connections and couplings shall be pulled up tight to provide an electrical bond throughout entire raceway system
3. Raceways shall be installed in such a manner that wires may be removed and replaced at a later date.
4. Raceways shall be run as direct as possible to minimize number of bends and offsets. Exposed raceways shall be installed with runs parallel or perpendicular to walls and ceilings and with right angle turns utilizing proper connectors, conduit bodies or symmetrical bends. In areas where vertical raceways will be exposed, raceways shall be run on building walls or columns where possible.
5. Running threads will not be permitted on raceways requiring threads. Approved threaded couplings or a conduit coupling shall be used where such construction is required.
6. Cylindrical metal raceways shall be bent only by use of an approved pipe bending machine so that raceway will always retain its cylindrical shape.
7. Furnish and install No. 12 non-ferrous or 200 lb. test nylon pull string in each spare or empty conduit. Conduit shall be identified at each end indicating destination and future use.
8. Caps shall be installed on all open conduit ends to protect against entrance of dirt and moisture.

B. Interior Raceways

1. Raceways shall be supported to building structure by use of beam clamps, one hole pipe straps where applicable, or other approved fasteners. Use of tie wire to support raceways will not be permitted.
2. Raceway runs shall be separated by a minimum of 6 inches from hot water pipes, steam pipes and flues inside the building. If a separation of 6 inches or greater cannot be maintained, an approved pipe covering shall be used over raceway runs for the length of such exposures.
3. Expansion joints, as specified for particular raceway system, shall be used on all runs that cross building expansion joints. Raceways shall cross building expansion joints at right angles. Free ends of conduits shall be installed in accordance with manufacturer's instructions.

C. Concrete Slab Raceways

1. Cylindrical metal or PVC schedule 40 raceways, as scheduled, may be laid below or poured in a concrete slab on grade, depending on the fill below slab, as specified for underground installation. Cylindrical metal raceways, as scheduled, shall be poured in a concrete slab above grade. Maximum diameter of raceways to be placed in slab shall be limited to 1/3 thickness of the slab. Exact placement of cylindrical raceways below or within concrete slab shall be verified with the prime professional.

2. Where cylindrical raceways are installed in concrete slabs, or under floor slabs, the minimum permissible size shall be 3/4-inch diameter.
3. Conduits for recessed floor boxes located in slabs on grade and slabs below grade shall be installed totally within the concrete slab with concrete totally encasing the conduits, including the point where conduits enter the recessed floor boxes, to ensure a watertight system and that water does not enter the conduit system. Coordinate with General Contractor.
4. All slab conduits for floor boxes shall be dry prior to installing cables.
5. Refer to Section 180050, Boxes, for additional information on recessed floor boxes and conduit connections to recessed floor boxes.

D. Underground Raceways

1. Raceway shall not be used in or under cinderfill where subject to permanent moisture unless protected on all sides by a layer of non-cinder concrete at least 2 inches thick or unless the raceway is at least 18 inches under the fill.
2. Underground raceways or duct banks shall have a marker and warning tape installed above raceway, 12 inches below finished grade. Use Tape Specification No. 2; refer to Section 180030, Wire and Cable, 600 Volts and Below. Duct banks with widths over 12 inches shall have 6-inch-wide tape runs installed side-by-side on 12 inch (maximum) centers. Warning tape shall be continuous for entire underground conduit run. Manufactures splices shall be used to connect tape for long runs.
3. Exterior steel conduit shall be coated with a bitumastic protective covering 6 inches above and below point where conduit enters ground. Bitumastic coating shall be top coated with a bituplastic coating above ground after bitumastic coating has been aged from 2 to 4 weeks. Refer to coating manufacturer's installation instructions.
4. Where conduits penetrate building walls, manhole walls, etc., underground penetration shall be made watertight and conduits shall be sealed with duct seal.

E. Raceway Specification

1. Rigid metal conduit shall be installed as follows:
 - a. Each end of every conduit run terminating in a steel enclosure of any type shall be provided with galvanized locknut with metal insulated throat bushing inside and galvanized locknut outside.
 - b. Bushing shall have ground lug where required.
 - c. Fittings specified under Raceway Specification No. 1 shall be used when installing rigid metal conduit.
 - d. Conduit bodies shall be used on exposed conduit runs, except at locations where impractical. At these impractical locations, factory ells shall be used. Factory ells will not be permitted on exterior of building.
 - e. All electrical raceway systems located on the exterior shall be installed to maintain a NEMA 4 rating using Myers hubs.
 - f. Where rigid metal conduit passes from one temperature zone to another, a conduit seal shall be installed on warmer side of wall.
 - g. Conduit seals shall be installed in conduit runs as required by National Electrical Code for hazardous areas.

F. Raceway Specification

1. Electrical metallic tubing shall be installed as follows:
 - a. Each end of every electrical metallic tubing run termination in a pressed steel box of any type shall be provided with an insulated throat EMT connector and locknut on the inside. Bushing with ground lug specified under Raceway Specification No. 1 shall be installed where required.
 - b. Appropriate threadless couplings and connectors shall be used with electrical metallic tubing and made up tight so when buried in masonry or concrete, raceway will remain dry at all times.
 - c. Fittings specified under Raceway Specification No. 1 shall be used when installing electrical metallic tubing.
 - d. Set screw connectors are acceptable for all feeders containing an equipment grounding conductor sized in accordance with the latest edition of the National Electric Code.
 - e. Set screw connectors are acceptable for branch circuits containing an equipment grounding conductor sized in accordance with the latest edition of the National Electric Code.

G. Raceway Specification

1. PVC conduit shall be installed as follows:
 - a. Joints in PVC conduit runs shall be in accordance with manufacturer's recommendations.
 - b. Expansion joints shall be installed where expansion and contraction of PVC conduit occurs due to changing temperature conditions.
 - c. PVC conduit shall not be used where subject to ambient temperature exceeding those which conduit has been approved.
 - d. Fittings specified under Raceway Specifications No. 4 shall be used when installing PVC conduit.

H. Raceway Specification

1. Flexible metal conduit shall be installed as follows:
 - a. Maximum length of flexible metal conduit permitted for final connection to motors and equipment shall be 2 feet. Flexible metal conduit for final connection to belt drives shall have sufficient slack to permit motor adjustment.
 - b. Maximum length of flexible metal conduit permitted for final connection to recessed lighting fixtures shall be 6 feet and minimum size of 3/8 inch diameter.
 - c. Fittings specified under Raceway Specification No. 5 shall be used when installing flexible metal conduit.

I. Raceway Specification

1. Liquidtight flexible metal conduit shall be installed as follows:
 - a. Maximum length of liquidtight flexible metal conduit permitted for final connection to motors and equipment shall be 2 feet. Liquidtight flexible metal conduit for final connection to belt drives shall have sufficient slack to permit motor adjustments.

- b. Fittings specified under Raceway Specification No. 6 shall be used when installing liquidtight flexible metal conduit.

J. Raceway Specification

- a. Cable trays shall be installed as follows:
- b. Cable tray shall be installed in accordance with NEMA VE2 and the manufacturer's recommendations.
- c. Cable trays shall be supported at midpoint of horizontal bends.
- d. Horizontal runs shall be supported at spacings recommended by manufacturer and as determined by the load/span class with concentrated load. Trapeze type hangers of 1-5/8 inch by 1-5/8-inch strut with 1/2-inch diameter threaded rods shall be used on spacing as approved by the manufacturer.
- e. Expansion joints shall be installed in cable trays at building expansion joints and in accordance with manufacturer's recommendations.
- f. Cable trays shall be mechanically connected at all joints, fittings, and connections to provide a continuous ground path and grounded in accordance with the National Electrical Code. Where ground path is interrupted due to routing or elevation changes, a copper grounding strap shall be installed.
- g. An equipment grounding conductor, size as indicated, shall be installed in all power cable tray runs.
- h. All power cables shall be secured to tray by metal cable clamps, as directed by manufacturer. All other cables may be secured using nylon cable straps.
- i. Sufficient space shall be provided around cable trays to permit adequate access for installing and maintaining cables. In stacked runs, distance from top of one tray to bottom of another tray shall not be less than 12 inches.
- j. Lay all wire and cables straight and parallel in tray.
- k. Gather all wires and cables of the same system in the trays together in bundles, if a combination of two or more multiple-conductor cables and/or single conductors are in the run. Determine the grouping and number of wires in each bundle in the field, mainly with consideration to physical locations of the routing and destination of the wires. Use nylon cable ties for bundling with a spacing between tie points of approximately 8 feet. Do all bundling and clamping before the end terminations are connected.
- l. Install cable trays to leave no exposed raw edges.
- m. Furnish and install on each side of cable tray, at minimum of 20 feet centers, a caution sign stating "DO NOT USE AS WALKWAY".

END OF SECTION

SECTION 180050
BOXES

PART 1 - GENERAL

1.1 WORK INCLUDED

- A. The Work of this Section shall consist of the labor, material and equipment required for furnishing and installing boxes. The specific application of these materials shall be as outlined in this Section and subsequent Sections of this Specification.

1.2 SUBMITTALS

- A. Submit for approval in accordance with specified submittal procedures:
 - 1. Boxes

PART 2 - PRODUCTS

2.1 BOX SPECIFICATION

- A. Acceptable Manufacturer: Steel City, or Appleton, Raco.
- B. Type: Recessed outlet boxes.
- C. Constructed of galvanized, 14 gage pressed steel, square corners, depth as required.
- D. Plaster rings for plaster areas.
- E. Masonry boxes in masonry areas.
- F. Rectangular type covers in special finished area, such as block, paneling or tile.
- G. Ganged, where indicated or required.

2.2 BOX SPECIFICATION

- A. Acceptable Manufacturer: Crouse Hinds FS or FD cast conduit fittings, or Appleton, Pyle ional, Killark, Adalet, OZ.
- B. Type: Surface outlet boxes.
- C. Constructed of copper free aluminum or rust resisting alloy of iron.
- D. Heavy, threaded hubs to fit applicable conduit.

- E. Cast malleable iron fittings shall be thoroughly coated with metallic zinc or cadmium, inside and outside, after all machine work is completed.
- F. Cast mounting lugs where lugs are required.
- G. Gasketed, watertight covers, same construction as box, and stainless steel screws.
- H. NEMA 4X, 316 stainless steel, where indicated, neoprene gasketed, watertight and stainless steel screws.
- I. NEMA 7 for hazardous areas.

2.3 BOX SPECIFICATION

- A. Acceptable Manufacturer: Steel City, or Appleton, Raco.
- B. Type: Junction boxes.
- C. Constructed of galvanized pressed steel, 14 gage, 4 inch square or octagon, depth as required.
- D. Plaster rings for plaster areas.
- E. Furnish and install fixture stud where required for lighting fixture support. Size stud as required to support weight of fixture, 3/8 inch minimum size. Stud shall be integrally fabricated with the box or inserted from back of box.

2.4 BOX SPECIFICATION

- A. Acceptable Manufacturer: Hoffman, or Keystone, Wiegmann, McKInstry.
- B. Type: Junction and pull boxes.
- C. Constructed of code gage galvanized steel sheet metal, reinforced where required.
- D. Riveted or welded joints.
- E. Furnish and install covers of same material of construction as box, screwed to box with stainless steel screws.
- F. Box size shall be sufficient to pull, rack, and splice cables.
- G. NEMA 3R in wet locations and on the exterior, neoprene gasketed, stainless steel screws.
- H. NEMA 4X, 316 stainless steel, where indicated, neoprene gasketed, watertight and stainless steel screws.

2.5 BOX SPECIFICATION

- A. Acceptable Manufacturer: Quazite Composites PC1118DA18 box with solid base; Quazite Composites PC1118SA00 steel locking cover; Quazite Composites PC1118HA00 locking cover.
- B. Type: Polymer concrete exterior service box, suitable for vehicular traffic.
- C. Constructed of polymer concrete and reinforced by a heavy-weave fiberglass.
- D. Stackable for extra depth.
- E. Stainless steel inserts and bolts.
- F. Enclosures and covers shall be rated for no less than 15,000 pounds over a 10 inch by 10 inch area.
- G. Nominal dimensions of 20 inches long by 13 inches wide by 18 inches deep.

PART 3 - EXECUTION

3.1 APPLICATION

- A. Unless noted, products and materials specified in this Section shall be installed in accordance with the following schedule(s):

BOX SCHEDULE - OUTLET AND JUNCTION BOXES

Application	Box Spec. No.
Recessed outlet boxes for wiring devices	1
Surface outlet boxes for wiring devices	2
Splice, junction, or pull boxes, interior	3 or 4
Splice or pullboxes, exterior and wet locations	4, NEMA 3R

BOX SCHEDULE - EXTERIOR

Application	Box Spec. No.
Splice, junction, or pull boxes, recessed in concrete floors; for exterior use - recessed in grade	35

3.2 INSTALLATION

A. General

1. Install boxes in accordance with manufacturer's instructions.
2. Outlet boxes shall be installed for weatherproof applications with wall plate lift covers hinged at top, to open lifting up.
3. All boxes shall be accessible.
4. Locations indicated are approximate. Coordinate in relation to spaces and equipment surrounding each outlet. When necessary, relocate outlets to avoid interference with mechanical equipment or structural features.
5. Locate all boxes for light switches on strike side of doors, unless otherwise indicated, or if building construction prohibits installation at this location. Locations at other than the strike side of the door shall be verified with the Owner before roughing in.
6. Locate all light fixture outlets in a symmetrical pattern according to the room layout unless otherwise indicated.
7. Mount all boxes plumb and level. Furnish and install flush proper type extension rings or plaster covers as required. For flush mounted boxes, make holes in the surrounding surface no larger than required to receive the box.
8. Open no more knockouts in sheet steel boxes than are actually required. Seal any used openings in any type box.
9. Boxes shall not be fastened to hung ceiling support wires.
10. Support all boxes independently of conduit.
11. Install boxes to maintain fire rating, where applicable.
12. Boxes shall not be installed exposed in finished areas without approval of the Owner.

B. Outlet Boxes

1. Outlet boxes of proper size and type shall be furnished at all outlets. Boxes shall be secured firmly in place and set true and square with building lines.
2. Openings for recessed outlet boxes shall be neatly cut, minimum size as needed for installation of box. Box shall be set at a depth so wall plate, when installed, shall cover wall opening and shall seat against the mounting surface on all sides.
3. Recessed outlet boxes shall be installed without damaging wall insulation and without reducing its effectiveness.

C. Junction and Pull Boxes

1. Junction, pull, or splice boxes shall be adequate size, suitable to construction features and independently supported.
2. Install boxes to maintain adequate head room.

D. Exterior Flush with Grade Boxes

1. Box and cover shall be suitable for heavy vehicular traffic. Pull box to be flush mounted with grade and be set in 6-inch minimum concrete, sides and bottom. All penetrations in pull box shall be made watertight.

3.3 DIMENSIONS

- A. Unless otherwise noted, dimensions are to the center of finished outlet with all wiring devices in place. Where indicated as clear, dimensions shall be to top or bottom of wiring device, plate, or trim.
- B. Dimensions specified herein shall be verified by Owner before roughing-in outlets.

3.4 LOCATIONS

- A. Locations of outlets and equipment shall be verified by Owner before roughing-in outlets or conduit.

****END OF SECTION****

SECTION 180060 WIRING DEVICES

PART 1 - GENERAL

1.1 WORK INCLUDED

- A. The Work of this Section shall consist of the labor, material and equipment required for furnishing and installing wiring devices. The specific application of these materials shall be as outlined in this Section and subsequent Sections of this Specification.

1.2 SUBMITTALS

- A. Submit for approval in accordance with specified submittal procedures:
 - 1. Switches
 - 2. Receptacles
 - 3. Wall Plates

PART 2 - PRODUCTS

2.1 SWITCHES

- A. Switch Specification
 - 1. Acceptable Manufacturer: Hubbell HBL1221 Series, or Bryant, Pass and Seymour, Cooper, Leviton.
 - 2. Type: Single or double pole, three-way or four-way 20 amp, 120/277 volts, AC.
 - 3. Back and side wired.
 - 4. Heavy duty, industrial specification grade.
 - 5. Silver cadmium oxide contacts.
 - 6. Steel, nickel plated corrosion resistant bridge.
 - 7. Nylon toggle.
 - 8. One-piece integral grounding terminal.
 - 9. Stainless steel automatic grounding clip.
 - 10. Key operated, where indicated, two keys furnished with each switch, Best core.

2.2 RECEPTACLES

A. Receptacle Specification

1. Acceptable Manufacturer: Hubbell HBL5362 Series 20 amp or Pass and Seymour, Bryant, Cooper, Leviton.
2. Type: Duplex, straight blade.
3. Rate 125 volts, 2 pole, 3 wire, grounding,
4. Heavy duty, industrial specification grade.
5. U-shaped slot for grounding.
6. Back or side wired.
7. NEMA Configuration: 20 amp - 5-20R.
8. One piece all brass mounting strap with integral ground contacts, ground plug retention clips, automatic grounding feature.
9. UL listed.
10. Nylon “finder groove” face and body, reinforced thermoplastic rynite base.
11. Listed “weather-resistant” type where installed in damp or wet locations.

B. Receptacle Specification

1. Acceptable Manufacturer: Hubbell GF5362 Series 20 amp, or Pass and Seymour, Bryant, Cooper, Leviton.
2. Type: Duplex, straight blade, ground fault circuit interrupter.
3. Rated 125 volts, 2 pole, 3 wire grounding.
4. Heavy duty, industrial specification grade.
5. U-shaped slot for grounding.
6. Nylon face.
7. Back or side wired.
8. NEMA Configuration: 20 amp - 5-20R.
9. Automatic grounding feature.
10. Test and reset button features.
11. Trip Threshold; 5 plus or minus 1 mA, Class A.
12. Trip Time: 0.025 seconds.
13. U.L. listed.
14. Dielectric – withstand 1500V minimum.
15. Maximum Interrupting Capacity – 2000 amp.
16. Indicator light to indicate tripped condition.
17. Upon pressing the test button, if electronics have failed unit will be locked out and not be resettable.

18. Listed “weather-resistant” type where installed in damp or wet locations.

C. Receptacle Specification

1. Acceptable Manufacturer: Hubbell HBL8410 30 amp, or Pass and Seymour, Bryant, Cooper, Leviton.
2. Type: Single, 125/250 volt.
3. Rated 125/250 volts, 3 pole, 4 wire grounding.
4. Slot for grounding.
5. Material and Color: 30 amp - black nylon.
6. NEMA Configuration: 30 amp - 14-30R.
7. U.L. listed.
8. Automatic grounding feature.

D. Receptacle Specification

1. Acceptable Manufacturer: Hubbell HBL9450A 50 amp, or Pass and Seymour, Bryant, Cooper, Leviton.
2. Type: Single, straight blade.
3. Rated 125/250 volts, 3 pole, 4 wire grounding.
4. Slot for grounding.
5. Material and Color: 50 amp - black nylon.
6. NEMA Configuration: 50 amp - 14-50R.
7. U.L. listed.
8. Automatic grounding feature.

E. Receptacle Specification

1. Acceptable Manufacturer: Hubbell HBL9367 Series 50 amp, Pass and Seymour, Bryant, Cooper, Leviton.
2. Type: Single, straight blade.
3. Rated 250 volts, 2 pole, 3 wire grounding.
4. U-shaped slot for grounding.
5. Material and color shall be black phenolic.
6. NEMA Configuration: 50 amp – 6-50R.
7. Automatic grounding feature.
8. U.L. listed.

2.3 COLOR

- A. Color of all wiring devices and wall plates shall be as directed by Owner.

2.4 WALL PLATES

A. Wall Plate Specification

1. Acceptable Manufacturer: Hubbell 'SS' Series, or Pass and Seymour, Bryant, Cooper, Leviton.
2. Stainless steel type 302/304, .04 inch thickness, satin finish, smooth (no lines).
3. 18 percent chromium and 8 percent nickel, non-magnetic.
4. Contoured edges.
5. Wall plates indicated to be engraved, shall be engraved by manufacturer.
6. Ganged plates where devices are ganged.
7. Screws with matching head finish supplied with plate.

B. Wall Plate Specification

1. Acceptable Manufacturer: Hubbell WP Series, single gang, or as approved.
2. NEMA 3R rating while in use, hinged cover/enclosure clearly marked "Suitable for Wet Locations While in Use".
3. Grey finish.
4. There shall be a gasket between the enclosure and mounting surface and between the hinged cover and mounting plate/base to ensure proper seal.
5. Stainless steel mounting screws.
6. Cast aluminum.
7. Vertical or horizontal mount.
8. Opening for either duplex receptacle or ground fault receptacle, as indicated.

2.5 CORD REELS

A. Cord Reel Specification

1. Acceptable Manufacturer: Hubbell HBL45 Series, or Appleton RL 100 Series, Coxreel EZ-PC Series.
2. Rated 20 amps, 120 volts.
3. Built-in cable locking ratchet, can be either activated or non-activated.
4. Adjustable four-roller cable guide.
5. Cord of type SO or SJT, #12, 2 wire plus ground, minimum 30 feet cord length.

6. Hubbell HBLPOBID box with cord strain relief on end of cord with the following:
 - a. Duplex receptacle, type as specified herein, and one duplex cover plate and one blank cover plate.
 - b. Two duplex receptacles, type as specified herein, and two duplex cover plates.
 - c. One ground fault receptacle, type as specified herein, one ground fault receptacle cover plate and one blank cover plate.
7. 20 amp, 125 volt, 2 pole, 3 wire grounding connector body and plastic coated, galvanized steel mesh "I" grip.

PART 3 - EXECUTION

3.1 APPLICATION

- A. Unless noted, products and material specified in this Section shall be installed in accordance with the following schedule(s):

WALL PLATE SCHEDULE	
Application	Wall Plate Spec. No.
Interior	W2
Exterior, Weatherproof (While in Use)	W9

3.2 INSTALLATION

A. General

1. Install all wiring devices in accordance with manufacturer's instructions, plumb and level.
2. All wall openings shall be neatly cut and covered by wall plates. Use oversize wall plates where needed.
3. Furnish and install wall plates on all wiring devices and all blank boxes.
4. Furnish and install zinc or cadmium coated steel plates on all surface "FS" boxes.
5. Coordinate with proper entity and verify mounting height of all wiring devices in field before rough-in.
6. Clean dirt, dust and debris from all outlet boxes, final cleaning shall be by vacuuming.

B. Switches

1. Install switches with "off" position down.
2. Switches shall not be connected to neutral conductor.
3. Switches shall be ganged where grouped at specific locations.

4. Switch outlets shall be located on strike side of door, unless otherwise indicated, or if building construction prohibits installation at this location. Locations at other than the strike side of the door shall be verified with the Owner before roughing in.
5. Operate each wall switch with circuit energized and verify proper operation.

C. Receptacles

1. Verify that each receptacle device is energized.
2. Install receptacles with 'U' shaped grounding slot up or to the left (if installed horizontally).
3. Test each receptacle device for proper polarity.
4. Where receptacles are installed in damp or wet locations, listed "weather-resistant" type receptacles shall be used. Damp and wet locations shall be as defined by Article 100 of the National Electrical Code.

D. Ground Fault Circuit Interrupter Receptacles

1. Verify that each receptacle device is energized.
2. Install receptacles with 'U' shaped grounding slot up.
3. Test each receptacle device for proper polarity.
4. Test each ground fault interrupter device for proper operation.
5. Ground fault interrupter receptacles shall not be wired for downstream protection.
6. Ground fault receptacles shall be installed in all toilet rooms.
7. Ground fault receptacles shall be installed within 6 feet of any type sink.
8. Ground fault circuit interrupter receptacles shall be provided within twenty-five feet of all HVAC equipment as required by the National Electrical Code.

E. Labeling

1. Refer to Section 180010, Basic Materials, for wall plate labeling requirements.

3.3 MOUNTING HEIGHTS

- A. Mounting height of outlets or receptacles serving special equipment or installed above a counter shall be determined in field.
- B. If the designated location of a switch or receptacle places it partially between two finishes, the actual location shall be adjusted to set the plate entirely on one finished surface only, but actual height shall not exceed mounting heights indicated herein or required by codes.
- C. Outlet boxes for flush mounted wiring devices installed in concrete masonry unit (block) or brick walls shall be installed so bottom of outlet box coincides with bottom of block or brick that is below specified mounting height, and actual height shall not exceed mounting heights indicated herein or required by code.

D. Mounting heights, measured to centerline, shall be as follows unless otherwise indicated:

1. Switches: 42 inches above finished floor
2. Receptacles: 18 inches above finished floor
3. Receptacles, Above Countertop: 6 inches above backsplash.
4. Weatherproof Receptacles on Exterior of Building: 24 inches above finished grade
5. Weatherproof Receptacles on Roof: 24 inches above roof

****END OF SECTION****

SECTION 180070 GROUNDING SYSTEMS

PART 1 - GENERAL

1.1 WORK INCLUDED

- A. The Work of this Section shall consist of the labor, material and equipment required for the installation of grounding systems and devices. The specific application of these materials shall be as outlined in this Section and subsequent Sections of this Specification.

1.2 SUBMITTALS

- A. Submit for approval in accordance with specified submittal procedures:
 - 1. Ground Rods
 - 2. Ground Connectors
 - 3. Grounding Bus Bars

PART 2 - PRODUCTS

2.1 GROUND RODS

- A. Acceptable Manufacturer: Copperweld, or Penn-Union, Weaver.
- B. Type: High strength steel core.
- C. Construction: Copper exterior welded to the steel core.
- D. Chamfered top to prevent mushrooming. Pointed end.
- E. Minimum Diameter
 - 1. 10-foot rod: 3/4-inch diameter.
 - 2. Above 10 feet: 1-inch diameter.
- F. For lengths over 10 feet, sectional rods with steel driving bolt may be furnished.

2.2 GROUND CONNECTORS

- A. Ground Connectors Specification
 - 1. Acceptable Manufacturer: OZ Types ABG, CG, DG, EG, FG, or HG, or Thomas & Betts.

2. Type: Wire to pipe connector. U-bolt, clamp type.
3. Copper alloy.

B. Ground Connector Specification

1. Acceptable Manufacturer: Thomas & Betts, or Burndy.
2. Type: Ground grid clamps. Compression connection to cable or rod.
3. High conductivity cast copper fittings.
4. Cable, rod, plate or combination connector, as required.
5. Suitable for direct burial or imbedded in concrete.

C. Ground Connector Specification

1. Acceptable Manufacturer: Erico Cadweld, or Burndy Thermite.
2. Type: Cadweld, exothermic welding process. Suitable for joining copper conductors.
3. Cable, rod, or surface connection, as required.

D. Ground Connector Specification

1. Acceptable Manufacturer: Copperweld Type AB, or Burndy, Penn Union, Dossert, Anderson.
2. Type: Cable to rod. Bolted pressure type.
3. Copper.
4. Nonferrous hex socket or hex head bolt.

2.3 GROUNDING BUSBAR

- A. Acceptable Manufacturer: Erico Eritech "EGBA" Series, Chatsworth or Newtown Instrument Co.
- B. Minimum 1/4 inch thick by 4 inches wide by 12 inches long copper bus bar.
- C. Hole pattern with alternate columns of 5/16 inch diameter holes and 7/16 inch diameter holes – 3 holes per column.
- D. Furnish with polyamide, glass fiber reinforced, stand-off insulators and stainless steel mounting brackets and stainless steel fasteners.
- E. Ground bar shall be bonded to structural steel column.
- F. Unless noted otherwise, all connections to the ground bus shall be made using two-hole compression connectors secured with two silicon bronze bolts, each with two washer, one lock washer and nut.

PART 3 - EXECUTION

3.1 APPLICATION

- A. Unless noted, ground connectors shall be installed in accordance with the following schedule(s):

GROUND CONNECTOR SCHEDULE	
Application	Ground Connector Spec. No.
Connection of ground wire to water pipe	1
Connection of ground wire or ground grid cable to ground rod, building steel or another ground grid cable	2 or 3
Connection of ground wire to ground rod	4

3.2 INSTALLATION

A. General

1. Unless otherwise specified, conductive noncurrent carrying electrical materials and equipment shall be grounded. Non-electrical items of equipment shall be bonded together. Grounding and bonding shall be in accordance with National Electrical Code requirements.
2. Bonds and jumpers shall be furnished and installed where required during construction and where necessary to ensure both operation and safety. Jumpers shall be installed around water meters and insulated pipe connectors.
3. Raceway system shall be grounded and shall be electrically, and mechanically continuous from all outlet devices, power utilization equipment, and distribution equipment to system main ground point.
4. Exact location and point of connection of main system grounds shall be verified during construction.
5. Ground wire shall be installed in raceway runs. Ground wires shall be insulated.
6. Grounding shall be by separate insulated grounding conductors installed in all raceway runs and pulled with phase conductors. Grounding system shall be electrically, and mechanically continuous from all outlet devices, power utilization equipment, and distribution equipment to system main ground point.
7. Neutral conductors shall be continuous throughout system and shall be grounded only at the existing switchboard neutral.
8. Electrical service shall be grounded in accordance with the National Electrical Code.
9. Separately derived systems shall be grounded in accordance with the National Electrical Code.

B. Ground Rods

1. As required by National Electrical Code.
2. Ground rods shall be driven to a depth so that top of rod is 2 feet below grade.

C. Building Structural Steel Ground

1. Building steel columns shall be connected to ground rods driven alongside column as indicated on Drawings. Provide #4/0 wire to connect to ground rod.
2. Building steel columns shall be connected to a #4/0 ground loop that shall completely encircle building. Ground loop shall be 30 inches (minimum) below finished grade and shall be approximately 24 inches to the outside of exterior column footers. Provide #4/0 wire to connect columns to ground loop.

3.3 TESTS

- A. Ground resistance of main system grounding point shall be tested and shall not exceed values required by National Electrical Code. Test shall be made using two auxiliary ground rod (three point) method or other approved method. If resistance is found to be higher than that allowed by National Electric Code, additional ground rods shall be driven until a resistance below allowed value is obtained.
- B. Outside tests shall not be performed during unusually wet conditions. Tests shall be made during dry weather conditions.
- C. Complete test record in triplicate shall be submitted to Owner stating allowable National Electrical Code Value, showing resistance values and calculations and shall indicate method of test.

END OF SECTION

**SECTION 180080
ELECTRICAL SERVICE**

PART 1 - GENERAL

1.1 WORK INCLUDED

- A. The Work of this Section shall consist of the labor, materials and equipment required for furnishing and installing the electrical service system.

1.2 SUBMITTALS

- A. Unless noted, submit for approval in accordance with specified submittal procedures:
1. Weatherheads
 2. Electrical System Overcurrent Protective Device Coordination Study
 - a. Provide for review minimum of 2 copies of a detailed overcurrent protective device coordination and short circuit analysis. Analysis shall begin at and include Power Company's nearest upstream protective device. Ground fault shall be included. Study shall end with either main breaker or largest branch breaker in lighting and appliance panelboards. Tie breaker, where indicated, will operate normally open. Study will be used to determine settings of protective devices for selective coordination. Equipment will be provided with ampere interrupting current rating and bus bracings equal to or greater than values indicated, these values will not be decreased as a result of short circuit study. Emergency electrical system shall be included in study.
 - b. All breakers shall be fully rated for short circuit interrupting, series connected ratings will not be approved.
 - c. The overcurrent protective device coordination and short circuit analysis shall be submitted prior to submission of switchgear, panelboards, motor control centers, etc., shop drawings. Submittals for switchgear, panelboards, motor control centers, etc., will not be reviewed and approved until the overcurrent protective device coordination and short circuit analysis has been submitted.
 3. Arc-Flash Hazard Analysis
 - a. Provide for review a minimum of 2 copies of a detailed Arc-Flash Hazard Analysis.
 - b. An Arc-Flash Hazard Analysis shall be performed on the entire facility electrical system. The analysis shall include both existing electrical equipment items and electrical equipment items furnished.
 - c. The Arc-Flash Hazard Analysis shall be performed with the aid of computer software intended for this purpose in order to calculate Arc-Flash Incident Energy (AFIE) levels and flash protection boundary distances.
 - d. The Arc-Flash Hazard Analysis shall be performed in conjunction with the Overcurrent Protective Device Coordination Study and Short Circuit Analysis.

- e. Results of the analysis shall be submitted in tabular form, and shall include, device or, bus name, bolted fault and arcing fault current levels, flash protection boundary distances, personal-protective equipment classes and AFIE levels.
 - f. The analysis shall be performed under worst-case arc-flash conditions, and the final report shall be describing, when applicable, how these conditions differ from worst-case bolted fault conditions.
 - g. The Arc-Flash Hazard Analysis shall be performed by a professional engineer registered in the state where the work is to be performed and shall be performed in compliance with IEEE standard 15842002, IEEE Guide for Performing Arc-Flash Calculations.
 - h. The Arc-Flash Hazard Analysis shall include recommendations for reducing AFIE levels and enhancing worker safety.
 - i. The proposed vendor shall demonstrate experience with Arc-Flash Hazard Analysis by submitting names of at least ten actual Arc-Flash Hazard Analysis it has performed in the past year.
 - j. The proposed vendor shall demonstrate capabilities in providing equipment, services, and training to reduce arc-flash exposure and train workers in accordance with NFPA 70E and other applicable standards.
 - k. The proposed vendor shall demonstrate experience in providing equipment labels in compliance with NEC-2002 section 110 and ANSI Z535.4 to identify AFIE and appropriate Personal Protective Equipment (PPE) classes.
 - l. Appropriate “Danger Labels”, as specified in Section 180010, Basic Materials, shall be placed on all items of electrical equipment. Included in the study. “Danger Label” shall, at a minimum, indicate the word message as specified in Section 180010, for “Danger Labels” and the following:
 - 1) Maximum voltage of the equipment.
 - 2) Arc-flash boundary
 - 3) Required PPE.
4. Information and data on existing electrical system components and equipment required for completion of the Overcurrent Protective Device Coordination Study and Short Circuit Analysis and Arc-Flash Hazard Analysis shall be collected by the contractor in the field.

1.3 ELECTRICAL POWER INTERRUPTIONS

- A. Interruptions of an established power supply shall be conducted only when authorized in writing by the Owner. Contractor shall submit a request to Owner for a service interruption and shall state the estimated time involved during which the power supply will be interrupted. Power supply interruptions shall be coordinated with the Owner and all other trades so there will be a minimum of inconvenience to these trades.
- B. Electrical work resulting in power supply interruptions to any building shall be performed during night hours or weekends and overtime costs incurred shall be included in the base bid.

1.4 COORDINATION OF ELECTRICAL SERVICE

- A. Contact applicable departments of the power company before beginning work on electrical service and to make arrangements to obtain permanent electrical service to the project.

- B. Meter location shall be approved by Power Company prior to installation of meter base.
- C. Power Company must approve location of pad mount transformer and inspect all phases of pad installation.
- D. Furnish and install lugs on secondary cables at pad mount transformer. Power Company will bolt lugs to transformer.
- E. Provide quantity and location of barriers around power company transformer pad as directed by Power Company.

****END OF SECTION****

SECTION 180090
AIR HAND DRYERS

PART 1 - GENERAL

1.1 AIR HAND DRYERS

A. Air hand dryers should meet the below specifications:

1. Elerator Excel Hand Drier Model XL-SB

****END OF SECTION****

SECTION 180100 PANELBOARDS

PART 1 - GENERAL

1.1 WORK INCLUDED

- A. The Work of this Section shall consist of the labor, materials and equipment required for furnishing and installing panelboards.

1.2 SUBMITTALS

- A. Submit for approval in accordance with specified submittal procedures:
 - 1. Panelboards and Devices

PART 2 - PRODUCTS

2.1 PANELBOARDS

- A. Acceptable Manufacturer:
 - 1. Alternate Bid: Siemens Industry.
 - 2. Base Bid: Square D.
- B. General: Panelboards shall be furnished complete with interior, box, trim and door, and constructed of code gage steel.
 - 1. Dead front construction
 - 2. Keyed alike.
 - 3. Furnished with manufacturer's nameplate and panelboard rating.
 - 4. Insert typewritten index card, verified for correctness, in frame provided on panel door.
- C. Devices shall be replaceable without removing adjacent devices and main bus connectors, as follows:
 - 1. Bolt-on breakers.
 - 2. Rated SWD for switching.
 - 3. Rated HACR where required for HVAC or refrigeration equipment.
 - 4. Rated for personnel ground fault circuit interrupter protection where indicated on drawings.

- D. Provide full height phase bus, provide full size neutral bus and ground bus, where applicable.
 - 1. Bus arranged for sequence phasing.
 - 2. Tin or silver plated aluminum busses or copper busses
 - 3. Provisions shall be bussed for maximum device that can be fitted into space.
- E. Panelboards used for service shall carry a label indicating suitability for service entrance.
- F. Double panels shall consist of two separate panels in separate, matching back boxes and trim. One panel shall have double lugs to feed the second panel. Feeder wires between panels shall be same size as feeder to panel. Breakers shall be divided equally between panels.
- G. Short circuit current rating of circuit breaker panelboards shall be equal to or greater than that of lowest interrupting rated device in panel.
- H. All breakers shall be mounted in the normal vertical breaker mounting space to the left or right of the main vertical bus. "Sub-feed" breakers and "individual" mounted breakers will not be approved.
- I. All breakers shall be fully rated for short circuit interrupting, series connected ratings will not be approved.

PART 3 - EXECUTION

3.1 INSTALLATION

- A. Install panelboards in accordance with manufacturer's recommendations. Submit manufacturer's printed installation instructions with operating and maintenance data at completion of Work.
- B. Panelboards shall be mounted 6 feet from finished floor to top protective device in panel.
- C. In areas with accessible ceilings, one 3/4-inch raceway, type as specified for branch wiring, shall be extended from all recessed panelboards and stubbed out above accessible tile ceilings for every three spare breakers and for every three provisions indicated in panel schedule.
- D. Provide for adequate clearances around panelboards.
- E. Ensure clear space over panels and no pipes or ducts are installed over panelboards, both in accordance with NEC.
- F. Rearrange circuits in panelboard to balance loads.

- G. Inspect for tightness of all connections.
- H. Panelboard indexes shall be provided to reflect installed condition. Indexes shall be typewritten and shall indicate room numbers and type of load served by each circuit. Coordinate final room numbers names, numbers and load descriptions with Owner.
- I. Refer to Section 180010, Basic Materials, for installation of “Danger Labels”.

3.2 EXISTING PANELBOARD MODIFICATIONS

- A. Where electrical modifications are performed on existing panelboards, panelboard indexes shall be revised to reflect modified condition. Revised indexes shall be typewritten and shall indicate room names, numbers and description of load served by each circuit. Coordinate final room numbers names, numbers and load descriptions with Owner.

END OF SECTION

SECTION 180110 DISCONNECT SWITCHES

PART 1 - GENERAL

1.1 WORK INCLUDED

- A. The Work of this Section shall consist of the labor, material and equipment required for the installation of disconnect switches. The specific application of these materials shall be as outlined in this Section and subsequent Sections of this Specification.

1.2 SUBMITTALS

- A. Submit for approval in accordance with specified submittal procedures:
 - 1. Disconnect Switches

PART 2 - PRODUCTS

2.1 DISCONNECT SWITCHES

- A. Acceptable Manufacturer:
 - 1. Alternate Bid: Siemens Industry.
 - 2. Base Bid: Square D.
- B. Type: Heavy duty, fusible or non-fusible.
- C. Ratings and Accessories:
- D. Standard Features:
 - 1. NEMA 1 enclosure, unless otherwise indicated.
 - 2. Handle padlockable in the off position, up to three padlocks.
 - 3. Quick-make, quick-break switching mechanism.
 - 4. Fuse clips shall have rejection type feature for the fuses specified.
- E. Furnish cover interlocks to prevent unauthorized opening of switch door when switch is in the on position, and to prevent closing switch mechanism when door is open.
- F. Disconnect used for service entrance shall carry a label indicating suitability for service entrance.

PART 3 - EXECUTION

3.1 INSTALLATION

- A. Install disconnect switches in accordance with manufacturer's instructions.
- B. Disconnect switches shall be installed 5 feet above finished floor.
- C. Fuse type and size as required shall be installed in fusible safety switches.

****END OF SECTION****

SECTION 180120 OVERCURRENT PROTECTIVE DEVICES

PART 1 - GENERAL

1.1 WORK INCLUDED

- A. The Work of this Section shall consist of the labor, material and equipment required for furnishing and installing overcurrent protective devices. The specific application of these materials shall be as outlined in this Section and subsequent Sections of this Specification.

1.2 SUBMITTALS

- A. Submit for approval in accordance with specified submittal procedures:
 - 1. Fuses, all types
 - 2. Circuit Breakers, all types
 - 3. Enclosed Circuit Breakers
 - 4. Coordination and Current Limiting Analysis (for substitute fuse manufacturer)

PART 2 - PRODUCTS

2.1 FUSES

- A. Coordination and current limiting for protection of portions of the electrical system has been designed on the base manufacturer of fuses specified herein for each type or class of fuses. The option to provide fuses manufactured by any substitute manufacture requires the submission of a written report verifying the substitute manufacturer's fuses will provide proper coordination and current limiting for those portions of the distribution system where the substitute fuses are proposed. Manufacturer's fuse curves for the proposed substitute fuses shall be included with the report. This report shall be submitted in same quantity and concurrent with shop drawing submission for fuses.
- B. Unless otherwise indicated, 10 percent (or a minimum of 3) spare fuses of each size and type shall be provided to Owner at completion of Work.
- C. Fuse Specification No. 2
 - 1. Acceptable Manufacturer: Bussman, or Littelfuse, Gould.
 - 2. Type: Buss fusetron, dual element.
 - 3. Class RK5, with rejection feature, 600 amps and below.

4. Fuse shall have either “blown fuse indicator” or “blown fuse indicating” fuse cover.

2.2 MOLDED CASE CIRCUIT BREAKERS - GENERAL

- A. Acceptable Manufacturer: Same as panelboard or switchboard manufacturer.
- B. Constructed of glass reinforced, or equal, insulation material with current-carrying components isolated from the handle and accessory mounting area.
- C. Molded case circuit breakers shall be over-center, trip free, toggle operating, quick-make, quick-break, manually operated, and, unless noted, with individual thermal and magnetic trip units in each pole.
- D. Individual trip mechanisms on each pole shall open all poles (common trip).
- E. Mechanically trip free so contacts cannot be held closed on an overload or short circuit.
- F. When tripped, circuit breaker handle shall reside in a position between “on” and “off”.
- G. Clearly marked “on” and “off” positions.
- H. Breakers shall be bolted to the bus, unless otherwise noted.
- I. Ratings shall be as indicated on Drawings. Ampere rating and U.L. and IEC certification standards with applicable voltage and ampere interrupting ratings shall be clearly marked on face of breaker.
- J. All breakers shall be fully rated for short circuit interrupting, series connected ratings will not be approved.
- K. Thermal trip units shall be factory preset and sealed.
- L. Breakers shall be true RMS current sensing.
- M. Breaker frames above 100 amps shall have a single magnetic trip adjustment accessible without removal of the breaker, cables, etc.
- N. Amperes Interrupting Current (AIC) Ratings: 120V, 208V, and 240V breaker - minimum AIC 10,000 amps.
- O. Amperes Interrupting Current (AIC) Ratings: 277V and 480V breaker - minimum AIC 14,000 amps.

2.3 GROUND FAULT BREAKERS – PERSONNEL PROTECTION

- A. Acceptable Manufacturer: Same as panelboard or switchboard manufacturer.
- B. Unless noted, all 15 amp and 20 amp, single pole breakers indicated as ground fault type shall be for personnel protection.

- C. Shall provide Class A protection – Trip when a fault current to ground is 6 milliamps or higher.
- D. Equipped with a push-to-trip button located on the face of the breaker to simulate a ground fault and mechanically operate the circuit breaker tripping mechanism for maintenance and testing purposes.
- E. Visual ground fault trip indication shall be provided.

2.4 SWITCHING DUTY BREAKERS

- A. Acceptable Manufacturer: Same as panelboard or switchboard manufacturer.
- B. U.L. listed as SWD (switching duty) rated.
- C. Suitable for switching fluorescent and HID lighting fixtures.
- D. Unless noted, all 15 amp and 20 amp, single pole breakers shall be SWD rated.
- E. All two pole and three pole breakers feeding fluorescent or HID lighting fixtures shall be SWD rated.

2.5 HEATING, AIR CONDITIONING AND REFRIGERATION BREAKERS

- A. Acceptable Manufacturers: Same as panelboard or switchboard manufacturer.
- B. U.L. listed as HACR (heating, air conditioning, refrigeration equipment) type breakers.
- C. All breakers feeding heating, air conditioning and refrigeration type equipment shall be HACR type breakers, verify with equipment installer.

PART 3 - EXECUTION

3.1 INSTALLATION

- A. Fuses
 1. Fuses shall not be installed until installation of equipment is complete and tests and inspections have been completed prior to energizing equipment, including thorough cleaning, tightening of electrical connections, inspection of ground and grounding conductors, and conductor insulation tests.
 2. Equipment shall not be shipped with fuses in place.
 3. Fuses identification label, indication type and size, shall be placed inside door of each switch.
 4. Fuse reducers shall be used where fuse gaps are larger than fuse dimensions.
- B. Circuit Breakers

1. Install circuit breakers in accordance with manufacturer's instructions.
2. Test all ground fault breakers to ensure proper operation.
3. On ground fault breakers for personnel, do not connect more than 250 feet of load conductor for the total one-way run (to prevent nuisance tripping).
4. On all adjustable trip circuit breakers, adjust all settings to values as indicated in the "Overcurrent Protective Device Coordination Study".

END OF SECTION

**SECTION 180130
DRY TYPE TRANSFORMERS**

PART 1 - GENERAL

1.1 WORK INCLUDED

- A. The Work of this Section shall consist of the labor, materials and equipment required for furnishing and installing dry type transformers.

1.2 SUBMITTALS

- A. Submit for approval in accordance with specified submittal procedures:
 - 1. Dry Type Transformers; performance characteristics, losses, and insulation system.

PART 2 - PRODUCTS

**2.1 DRY TYPE TRANSFORMER, 37-1/2 TO 500 KVA - UNDER 600 VOLTS -
115 DEGREES C RISE**

- A. Acceptable Manufacturer:
 - 1. Alternate Bid: Siemens Industry.
 - 2. Base Bid: Square D.
- B. Transformer shall be ventilated.
- C. Transformer losses shall be in compliance with Federal Law 109-58, Energy Act of 2005, and shall conform to the latest edition of NEMA TP-1. Transformers shall be loss tested by the manufacturer in accordance with and to comply with the latest revision of NEMA TP-2. Transformers shall be labeled in accordance with the latest version of NEMA TP-3.
- D. Provide NEMA standard taps, two 2-1/2 percent full capacity both above and below normal.
- E. Transformers shall be 115 degrees C. rise above 40 degrees C. ambient. 115 degrees C. rise transformers shall be capable of carrying a 15 percent overload without exceeding a 150 degrees C. rise in a 40 degrees C. ambient, and without use of cooling fans.
- F. Insulation: UL 220 degrees C. system in accordance with NEMA standards.
- G. Construction: In accordance with latest revised standards of IEEE, ANSI and NEMA. UL listed.
- H. 600V transformer and below shall have a BIL of 10 KV.

- I. Sound level shall not exceed:

37-1/2 TO 50 KVA	45 db
50 to 150 KVA	50 db
151 to 300 KVA	55 db
301 to 500 KVA	60 db

- J. Terminals shall be located so as to insure terminations in ambient temperature levels - side or bottom conduit entrance. Provide terminals of sufficient size and number to accommodate NEC rated cable and conduit sizes.

- K. Lifting holes shall be usable without removing any enclosure components.

2.2 DRY TYPE TRANSFORMER, 1/4 TO 30 KVA - UNDER 600 VOLTS

- A. Acceptable Manufacturer:
 1. Alternate Bid: Siemens Industry.
 2. Base Bid: Square D.

- B. Transformer shall be ventilated.

- C. Where applicable, transformer losses shall be in compliance with Federal Law 109-58, Energy Act of 2005, and shall conform to the latest edition of NEMA TP-1. Transformers shall be loss tested by the manufacturer in accordance with and to comply with the latest revision of NEMA TP-2. Transformers shall be labeled in accordance with the latest version of NEMA TP-3.

- D. Provide NEMA standard taps, two 2-1/2 percent full capacity both above and below normal.

- E. Insulation System
 1. 3 thru 30 KVA: Insulation system shall be UL approved 185 degrees C. system; average conductor temperature rise shall not exceed 115 degrees C. at rated load in an ambient of 40 degrees C.; ultimate hot-spot temperature rise shall not exceed 30 degrees C.
 2. Below 2 KVA: Insulation system shall be UL approved 150 degrees C. system; average conductor temperature rise shall not exceed 80 degrees C. at rated load in an ambient of 40 degrees C.; ultimate hot-spot temperature rise shall not exceed 30 degrees C.

- F. Construction: In accordance with latest revised standards of IEEE, ANSI and NEMA. UL listed, where listing applies.

- G. 600V transformer and below shall have a BIL of 10 KV.

- H. Sound level shall not exceed:

1/4 to 9 KVA	40 db
10 to 30 KVA	45 db

- I. Terminals shall be located so as to insure terminations in ambient temperature levels - side or bottom conduit entrance. Provide terminals of sufficient size and number to accommodate NEC rated cable and conduit sizes.
- J. Lifting holes shall be usable without removing any enclosure components.

PART 3 - EXECUTION

3.1 INSTALLATION

- A. Install transformers in accordance with manufacturer's instructions. Submit manufacturer's printed installation instructions with operating and maintenance data at completion of Work.
- B. Allow for adequate ventilation space around transformer in accordance with manufacturer's instructions.
- C. Tighten connections prior to energizing.
- D. Measure voltage and make appropriate tap adjustments.
- E. Install using spring hangers when supported from building steel.

3.2 ON-SITE TESTING

- A. Dry type transformers over 600 volts shall be tested on site before energization in accordance with NETA testing procedures for dry type transformers over 600 volts. Test results shall be turned over to Owner.
- B. Testing shall be performed by an independent testing organization.

****END OF SECTION****

SECTION 180140 LIGHTNING PROTECTION

PART 1 - GENERAL

1.1 WORK INCLUDED

- A. The Work of this section shall consist of the labor, materials and equipment required for the furnishing and installing of lightning protection system.

1.2 SUBMITTALS

- A. Submit for approval in accordance with specified submittal procedures:
 - 1. Shop drawings showing layout of air terminals, grounding electrodes, cable routing, and bonding connections to structure and other metal objects. Include terminal, electrode, and conductor sizes, and connection and termination details.
 - 2. Product data showing dimensions and materials of each component. Verify listing in accordance with ANSI/UL 96.

1.3 REFERENCES

- A. LPI Lightning Protection Institute.
- B. UL 96A Installation Requirements for Lightning Protection Systems.
- C. NFPA 78 Lightning Protection Code.
- D. UL 96 Lightning Protection Components.

1.4 COORDINATION

- A. Coordinate the Work of this Section with existing roofing, exterior and interior finishes.

1.5 SYSTEM DESCRIPTION

- A. Lightning Protection System: ANSI/NFPA 78; Class I or Class II UL 96A; Master Labeled system protecting building, consisting of air terminals on roofs, roof mounted mechanical equipment, chimneys and stacks, and penthouse roofs; bonding of structure and other metal objects; grounding electrodes; and interconnecting conductors.
- B. Rooftop mechanical equipment is six to eight feet above roof.

- C. Visit site to verify existing conditions, existing roof elevations and existing rooftop mechanical equipment and stacks.

1.6 QUALIFICATIONS

- A. Manufacturer: Company specializing in lightning protection equipment with minimum three years documented experience and member of the Lightning Protection Institute.
- B. Installer: Authorized installer of manufacturer with minimum three years documented experience and member of the Lightning Protection Institute.

PART 2 - PRODUCTS

2.1 MATERIALS

- A. Components: In accordance with ANSI/UL 96.
- B. Air Terminals: Solid copper.
- C. Air Terminal for Chimney: Lead coated copper.
- D. Grounding Rods: Stainless steel.
- E. Ground Plate: Copper.
- F. Conductors: Copper cable.
- G. Connectors and Splicers: Bronze.
- H. Screws and Fasteners: Stainless steel.
- I. Conduit: Raceway Specification No. 4, size as required.

PART 3 - EXECUTION

3.1 INSTALLATION

- A. Air Terminals: Shall be spaced at intervals not to exceed code requirements and extend above the protected area and all items to be protected.
- B. Conductors: Shall be secured on 3' 0" centers and shall maintain a horizontal or downward course.
- C. Conductor Bend Angles: Shall be maximum 90 degrees with a minimum radius of 8 inches.

- D. Down Conductors: Shall run in a 1-1/4 inch PVC conduit with code required cable support at a maximum of a 100 feet distance on a reinforced concrete building. PVC conduit shall be schedule 40 painted over its entire length to match adjacent wall surfaces. Follow master label criteria for other types of construction.
- E. Ground Electrode: Connecting to a rod or wing plate shall be made at minimum 2' 6" below grade and minimum 4' 0" away from footing of foundation wall.
- F. Bond: All metal bodies within 6' 0" from the lightning conducting system or a metal body 6' 0" away, already bonded to the system.
- G. Metal Bodies: Extending above the highest air terminal shall be bonded to the system.
- H. Tagging: All ground terminals shall be tagged indicating exact vertical depth and tag shall be attached to or adjacent to each down conductor at 3 feet to 6 feet above grade.

3.2 PROTECTION OF SURROUNDING ELEMENTS

- A. Protect elements surrounding Work of this Section from damage or disfiguration.

3.3 EXAMINATION

- A. Verify that surfaces are ready to receive work.
- B. Verify that field measurements are as shown on shop drawings.
- C. Verify existing building conditions at site. Submission of shop drawings shall be interpreted to mean installer has visited site, has become familiar with exiting conditions and accepts existing conditions.

3.4 CERTIFICATION

- A. The system shall be the product of a manufacturer regularly engaged in production of lightning protection systems and installed by a contractor regularly engaged in the installation of lightning protection systems.
- B. Obtain the service of Underwriters Laboratories, Inc. to provide inspection and certification of the lightning protection system under provisions of UL 96A.
- C. Upon completion of the installation deliver to Owner a MASTER LABEL issued by the Underwriters' Laboratories. In the event the master label is not awarded by the Underwriters' Laboratories due to adjacency to a non-protected facility, furnish a certificate of compliance indicating the work was installed in compliance with all rules and regulations of the UL regarding a master label installation.

END OF SECTION

SECTION 180150 LIGHTING

PART 1 - GENERAL

1.1 WORK INCLUDED

- A. The Work of this Section shall consist of the labor, materials and equipment required for furnishing and installing lighting fixtures, complete with lamps, for each lighting outlet and other items associated with lighting as specified herein.

1.2 SUBMITTALS

- A. Submit for approval in accordance with specified submittal procedures:
 - 1. Ballasts
 - 2. Lamps, including schedule of lamp types
 - 3. Exit Signs
 - 4. Lighting Fixtures
 - 5. Exterior light poles, fixtures

1.3 SUBSTITUTIONS

- A. A substitute Electrical Contractor shall furnish and install quantities of all lighting fixtures, junction boxes, wiring, conduit, and other accessories which comprise the entire lighting system as required to conform to the indicated performance criteria. Electrical Contractor shall provide all quantities required at no additional cost to Owner.

PART 2 - PRODUCTS

2.1 FLUORESCENT FIXTURE BALLASTS

- 1. Electronic Ballast, Instant Start, T8 Lamps
 - a. Acceptable Manufacturer: Advance Centium.
 - b. Power Factor: 0.98 or higher for four foot lamps.
 - c. Average Ballast Factor: 0.88 or greater.
 - d. Input Current Total Harmonic Content: Not exceeding 15 percent.
 - e. Shall meet the requirements of Federal Communications Commission Rules and Regulations, Part 18.
 - f. Shall not contain polychlorinated biphenyls (PCB's).

- g. Shall consist of rectifier, high frequency inverter and power, control and regulating circuitry.
- h. Shall withstand line transients as defined in ANSI C62.41, Category A.
- i. Enclosure size, mounting and wiring same as electromagnetic ballasts.
- j. Class P and sound rated "A".
- k. Support a sustained short to ground or open circuit of any output leads without damage to ballasts.
- l. Maintain lamp current crest factor below 1.7.
- m. Low temperature start down to -20 degrees Celsius.
- n. Five-year warranty.
- o. Average Ballast Life: 50,000 hours.
- p. UL listed.
- q. NEMA premium ballast.
- r. Input watts shall not exceed the following:

<u>No. of T8 Lamps</u>	<u>Lamp Watts</u>	<u>Input Watts</u>
1	17	17
2	17	33
3	17	48
1	32	31
2	32	59
3	32	85

- 2. Electronic Ballast, 0-10V Dimming, T8 Lamps
 - a. Acceptable Manufacturer: Advance Mark 7 0-10 V.
 - b. Power Factor: Greater than 0.98 at full light output and greater than 0.90 throughout the dimming range.
 - c. Input Current Total Harmonic Content: Shall not exceed 10 percent at full brightness and 20 percent across the full dimming range for all lamps.
 - d. Shall meet the requirements of Federal Communications Commission, Class A (non-consumer) specifications for EMI/RFI.
 - e. Shall withstand line transient as defined in ANSI C62.41, Category A (IEEE587).
 - f. Dimming Range – 100 percent to 5 percent.
 - g. Class P and sound rated "A".
 - h. Support a sustained short to ground or open circuit of any output leads without damage to ballast.
 - i. Maintain lamp current crest factor equal to or less than 1.7.
 - j. Ballast capable of striking lamps at any light level without first flashing to full light.
 - k. Low temperature start down to -20 degrees Celsius.
 - l. Five-year warranty.
 - m. Ballast shall be compatible with specified lamp type and wattage.
 - n. Contractor shall furnish 0-10V control wiring as required for application.
 - o. Average ballast life of 50,000 hours.
 - p. UL listed.

2.2 LAMPS

- A. Acceptable Manufacturer: General Electric, or Philips Lighting, Osram-Sylvania, unless noted otherwise.

- B. Lamps shall be of the type and rating specified herein.
- C. If fluorescent or HID fixtures are used by Contractor for more than 2000 burning hours as temporary lighting or security lighting, all lamps shall be replaced prior to acceptance of the Work.
- D. Lamps, T8 – Extended Life
 - 1. Acceptable Manufacturer: Philips Lighting 800 XLL Series, or General Electric, Osram-Sylvania.
 - 2. Electrode guard around each electrode to effectively reduce lamp end darkening or other means to prevent end darkening as submitted with lamp shop drawings.
 - 3. CRI of 82 or greater.
 - 4. 46,000 hour average life, 48 month warranty, Instant Start.
 - 5. Lumen maintenance of .95 or greater over the life of lamp.
 - 6. 17 watt, 2 foot lamps; 32 watt, 4 foot lamps.
 - 7. 3500K.

2.3 LED LUMINAIRES

- A. LED array color and lumen output shall be determined by Owner. Chips shall be binned to no more than 2-step MacAdam Ellipse.
- B. Minimum manufacturer stated LED lifetime shall be 50,000 hours or as indicated on fixture schedule. Lifetime shall be considered predicted time where average lumen output reaches 70 percent of initial output as measured in accordance with IESNA LM-80 testing requirements.
- C. Driver shall be rated for 120 volt to 277 volt input.
- D. Power Factor: Greater than 90 percent.
- E. Minimum Efficiency: 85 percent.
- F. Dimming: 0-10VDC standard.
- G. Luminaire shall comply with FCC Title 47 CFR Part 18 Non-consumer RFI/EMI Standards.
- H. Drivers shall be reduction of hazardous substances (ROHS)-compliant.
- I. Minimum 5 year warranty on all LED arrays and drivers.
- J. UL listed.

2.4 EXIT SIGNS

- A. Illuminated Exit Sign, LED White Thermoplastic
 - 1. Acceptable Manufacturer: Emergi-Lite (LED) Premier Series.

2. Red light emitting diodes, less than 5 watt draw.
3. Frame, backplate, faceplate and mounting canopy constructed of high impact off-white thermoplastic.
4. Optical diffuser to protect LED's and provide uniform LED light output.
5. 120/277 dual voltage.
6. Stencil face, red letters, minimum 5 inches high, 2 inches wide (except for "I") and minimum 3/4-inch stroke.
7. Distance between letters shall be 3/8 inch minimum.
8. Single face or double face as required.
9. Warranty: 5-year full warranty beginning on date of acceptance by Owner.

2.5 FUSING

- A. All fluorescent fixtures shall be fused.

2.6 LIGHTING FIXTURES

- A. The term "acrylic", as applied to fluorescent lighting fixture enclosures, shall require the side and bottom panels, or the complete wrap around enclosure, to be formed from virgin acrylic compounds. Mixtures of acrylic or any other plastic material will not be permitted.

2.7 RACEWAYS

- A. Underground raceways for exterior lighting fixtures shall be Raceway Specification No. 4.

PART 3 - EXECUTION

3.1 INSTALLATION

- A. Lighting Fixtures
 1. Contractor shall consult room finish schedule for type of ceiling construction and shall be responsible for installing proper fixture with required hardware for specified ceiling. All recessed fixtures in plaster ceilings shall include a plaster frame and a matt white trim finish unless noted.
 2. Furnish necessary supports, hangers and hardware to properly secure fixtures to building structures. Fixtures shall be securely hung in place, properly wired and connected to branch circuits, lamped, tested, cleaned, and left ready for operation.

3. Support all ceiling fluorescent lighting fixtures in lay in ceilings with one end of each tie wire attached directly to each corner of the fixture and the other end of each tie wire attached directly to the building structure above in accordance with code requirements.
4. Fixtures shall be provided only with type of lamps recommended by fixture manufacturer.
5. Lamps and ballasts shall be compatible.
6. Diffusers, lenses, globes, etc., shall be as scheduled and shall be suitable for the light fixture according to fixture manufacturers recommendation. All items shall be inspected for breakage, cracks, and chips before installation. All diffusers shall be wiped clean and dust free with a soft cloth.
7. Use of a manufacturer's catalog number shall not relieve Contractor from furnishing a complete unit, whether a required accessory is or is not part of the catalog number specified.
8. Rating of wire to all fixtures shall be compatible with fire rating of fixture.
9. Lighting fixtures shall be grounded by grounding wire. Suspended fixtures shall be served with a three conductor cord or circuit using a green bond wire for connection to the outlet box or raceway.

B. Multiple Level Lighting

1. Areas indicated as "switched for multiple or multi-level" shall have inside lamps of fixtures in that area controlled by one switch and outside lamps of fixtures in that area controlled by another switch.
2. Fixtures shall have quantity of ballasts as required for the number of switching levels indicated.

C. Normal/Emergency Lighting

1. Three or four-lamp fixtures wired for both normal and normal/emergency shall have the inside lamps on normal/emergency and the outside lamps on normal.
2. Fixtures shall have quantity of ballasts as required for both normal and normal/emergency wiring.

3.2 FIXTURE AIMING

- A. Aiming of all adjustable fixtures shall be performed to the satisfaction of Owner. Final aiming of all adjustable fixtures shall be performed in the presence of Owner.

END OF SECTION

SECTION 180160
EXTERIOR LIGHTING

PART 1 - GENERAL

1.1 OUTDOOR WALL MOUNT LIGHT

- A. RUUD – CL Series
- B. RUUD – SE Series

1.2 OUTDOOR SIDEWALK LIGHT

- A. LITHONIA CATALOG NUMBER CSX2 LED 3 30B530/40K SR2 277 SPA SF

1.3 PARKING LOT POLE LIGHT

- A. LITHONIA CATALOG NUMBER SSA 25 5G DM19 DDB

****END OF SECTION****

SITE LIGHTING FIXTURE SCHEDULE

MESSIAH COLLEGE

PROJECT: STUDENT ENHANCEMENT PROJECTS

ISSUE DATE: 05/14/15

REVISIONS:





TYPE	DESCRIPTION	MANUFACTURER	CATALOG #	LAMP QTY.	LAMP TYPE	MAX. WATT	VOLTS	MOUNTING	REMARKS
S1	POST-TOP LED LUMINAIRE	ARCHITECTURAL AREA LIGHTING	UCM SR-BEL T3-32LED 4K 450 MDG SLA24	1	LED, 4200K	50	120/277	MATCHING DB12-4R16 DECORATIVE 16' POLE	PRINTED CIRCUIT BOARD ASSEMBLY (32 LEDs)

FEATURES

- DLC qualified
- Up to 1000' wireless communication
- Motion sensing up to 40' mounting height
- Superior BUG ratings
- Types II, III, IV, V and custom distributions
- IP66, 3G vibration housing
- 20kV/10kA surge suppression
- 2700 – 5000K CCT
- >560 nm Amber
- Custom lumen packages
- Integral thermal protection
- 0-10V dimmable
- 13 standard powder coat finishes

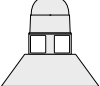

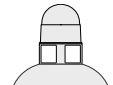
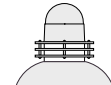
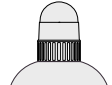
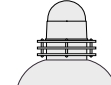

SPECIFICATIONS

					
ANGLED HOOD CONFIGURATION	UCM-ANG	UCM-WND-ANG	UCM-SR-ANG	UCM-VSL-ANG	UCM-LUM-ANG
DIAMETER	20"/508mm	20"/508mm	20"/508mm	20"/508mm	20"/508mm
HEIGHT	14.7"/373mm	20.5"/520mm	20.7"/526mm	20.5"/521mm	20.6"/523mm
WEIGHT	18.25 lbs/8.28kg	21.75 lbs/9.86kg	25 lbs/11.3kg	22.25 lbs/10.1kg	24.25 lbs/11kg
EPA	.60	.72	.74	.72	.74

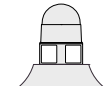
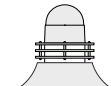
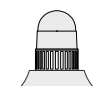
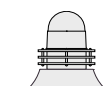
					
BELL HOOD CONFIGURATION	UCM-BEL	UCM-WND-BEL	UCM-SR-BEL	UCM-VSL-BEL	UCM-LUM-BEL
DIAMETER	24"/610mm	24"/610mm	24"/610mm	24"/610mm	24"/610mm
HEIGHT	15.8"/401mm	21.4"/543mm	21.6"/549mm	19.37"/492mm	21.5"/546mm
WEIGHT	20.25 lbs/9.2kg	23.5 lbs/10.6kg	27 lbs/12.25kg	24.25 lbs/11kg	26 lbs/11.8kg
EPA	.73	.85	.87	.85	.85

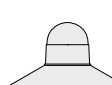
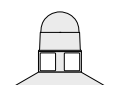
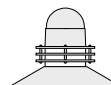
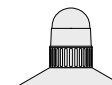
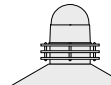
					
FLARE HOOD CONFIGURATION	UCM-FLR	UCM-WND-FLR	UCM-SR-FLR	UCM-VSL-FLR	UCM-LUM-FLR
DIAMETER	22"/559mm	22"/559mm	22"/559mm	22"/559mm	22"/559mm
HEIGHT	14.5"/368mm	19.8"/503mm	20.1"/510mm	19.8"/503mm	20"/508mm
WEIGHT	18.5 lbs/8.4kg	21.75 lbs/9.87kg	25.25 lbs/10.1kg	21.75 lbs/9.86kg	24.25 lbs/11kg
EPA	.53	.65	.67	.65	.67

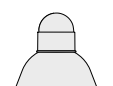
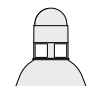
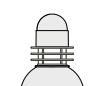
					
STRAIGHT HOOD CONFIGURATION	UCM-STR	UCM-WND-STR	UCM-SR-STR	UCM-VSL-STR	UCM-LUM-STR
DIAMETER	24"/610mm	24"/610mm	24"/610mm	24"/610mm	24"/610mm
HEIGHT	14"/355mm	19.8"/503mm	20"/508mm	19.8"/503mm	19.9"/505mm
WEIGHT	20 lbs/9.07kg	23.25 lbs/10.55kg	26.75 lbs/12.13kg	23.75 lbs/10.77kg	25.75 lbs/11.68kg
EPA	.59	.71	.73	.71	.73

					
SKIRTED BELL HOOD CONFIGURATION	UCM-SKB	UCM-WND-SKB	UCM-SR-SKB	UCM-VSL-SKB	UCM-LUM-SKB
DIAMETER	24"/610mm	24"/610mm	24"/610mm	24"/610mm	24"/610mm
HEIGHT	19.7"/500mm	23.9"/607mm	24.2"/615mm	23.9"/607mm	24.1"/612mm
WEIGHT	20.5 lbs/9.3kg	23.75 lbs/10.77kg	27 lbs/12.25kg	24.25 lbs/11kg	26.25 lbs/11.9kg
EPA	.90	1.03	1.05	1.03	1.05



3000K unlit or 3000K without luminous element only

JOB	_____
TYPE	_____
NOTES	_____

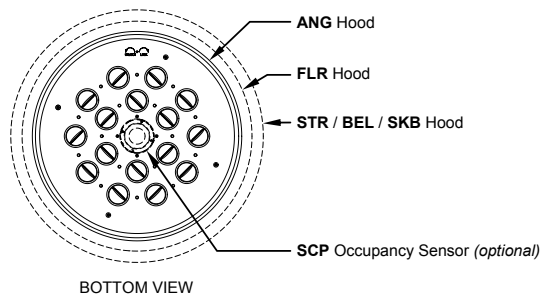

ORDERING INFORMATION

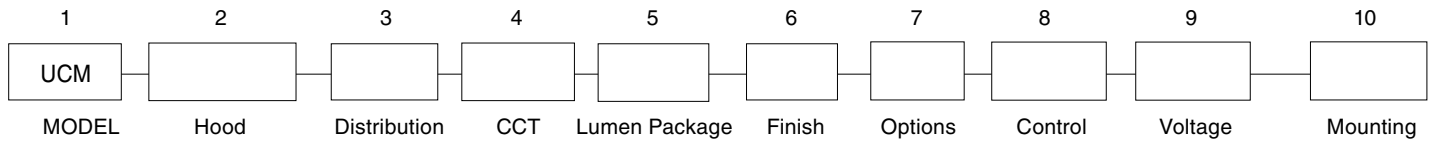

1. MODEL

UCM	Universe medium without luminous element
UCM-WND	Universe medium with luminous window
UCM-SR	Universe medium with luminous solid rings
UCM-VSL	Universe medium with luminous vertical slots
UCM-LUM	Universe medium with luminous rings

2. HOOD (May choose one)

FLR	Flared hood
FLR-STSS	Flared hood in natural brushed stainless steel
FLR-COP	Flared hood in natural brushed copper
ANG	Angled hood
ANG-STSS	Angled hood in natural brushed stainless steel
ANG-COP	Angled hood in natural brushed copper
STR	Straight hood
STR-STSS	Straight hood in natural brushed stainless steel
STR-COP	Straight hood in natural brushed copper
BEL	Bell hood
BEL-STSS	Bell hood in natural brushed stainless steel
BEL-COP	Bell hood in natural brushed copper
SKB	Skirted bell hood
SKB-STSS	Skirted bell hood in natural brushed stainless steel
SKB-COP	Skirted bell hood in natural brushed copper

3. DISTRIBUTION

MicroCore Precision aimed optics

T2-32LED	Type 2
T3-32LED	Type 3
T4-32LED	Type 4
T5-32LED	Type 5
TX-32LED	Custom ¹

4. COLOR TEMPERATURE

3K	3000K
4K	4000K
5K	5000K
27K	2700K ¹
35K	3500K ¹
AM	>560 nm monochromatic amber ¹

5. LUMEN PACKAGE

700	71 watts
450	48 watts
XMA	Custom wattage or drive current ¹

6. FINISH

Standard Color

WH	Arctic White
BL	Black
BLT	Matte Black
DB	Dark Bronze
DGN	Dark Green
TT	Titanium
WDB	Weathered Bronze
MDB	Bronze Metallic
VBU	Verde Blue
CRT	Corten
MAL	Matte Aluminum
MG	Medium Grey
AGN	Antique Green
LG	Light Grey

Premium Color

SHK	Shamrock
SPP	Salt and Pepper
SFM	Seafoam
WCP	Weathered Copper
RAL	RAL 4 digit Color
CUSTOM	Custom Color

7. OPTIONS (May choose as noted)

FTG	Flat clear glass lens ²
FLD	Flat diffused glass lens ³
SAG	Sag clear glass lens ^{1,3}
HSS	House Side shield for Type 4
SLC	Unlit (luminous) element
R80	80 CRI minimum ¹
BLU	Blue inner lens
RD	Red inner lens
GRN	Green inner lens

8. CONTROLS – (May choose as noted)

WIR	wiScape connectivity
WIRSC	wiScape connectivity, integral motion sensor
SCP	Integral photo-control and motion sensor ⁴
SCPREMOTE	Handheld commissioning tool ⁴

9. VOLTAGE

120-277	120-277 VAC input
347	347 VAC input
480	480 VAC input

9. MOUNTING

POLE MOUNT

SLA2	SLA3	SLA4
SLA4-2	SLA7	SLA7-2
SLA7(5)	SLA7(5)-2	SLA8D
SLA9	SLA9-2	SLA10
SLA10-2	SLA16	SLA16-2
SLA17	SLA17-2	SLA17(5)
SLA17(5)-2	SLA18	SLA18-2
SLA20	SLA20-2	SLA20A
SLA20A-2	SLA20B	SLA20B-2
SLA20C	SLA20C-2	SLA20D
SLA20D-2	SLA22D	SLA24
SLA24-2	SLA24(5)	SLA24(5)-2
TRA4	TRA7	TRA7-2
TRA8	TRA8-2	TRA9
TRA9-2		

WALL MOUNT

WMA4	WMA5	WMA6
WMA8	WMA9D	WMA10
WMA11	WMA12	WMA16
WMA17	WMA18	WMA20
WMA22D	WMA24	WMA37
WMA38	WMA39	

PENDANT MOUNT

PMS

¹ Contact factory
² Not for AM color temperature
³ Not for WIR, WIRSC or SCP control options
⁴ Handheld commissioning tool is required to separately configure or adjust any number of SCP sensors.



ARCHITECTURAL AREA LIGHTING
 17760 Rowland Street | City of Industry | CA 91748
 P 626.968.5666 | F 626.369.2695 | www.aal.net
 Copyright © 2014 March 7, 2017 2:58 PM

JOB	_____
TYPE	_____
NOTES	_____

LUMINAIRE PERFORMANCE Actual measured performance to be within +/-3%of the stated values

Configuration			Ordering Code	32LED-5K-700					32LED-4K-700					32LED-3K-700							
System Watts	Luminous Element	Lens		Distribution	Bright White (5000K)			Neutral White (4000K)			Warm White (3000K)										
					Delivered Lumens	Efficacy (Lm/W)	BUG Rating	Delivered Lumens	Efficacy (Lm/W)	BUG Rating	Delivered Lumens	Efficacy (Lm/W)	BUG Rating								
				B	U	G	B	U	G	B	U	G	B	U	G						
71	(None)	(None)	Type II	UCM-[HOOD]-T2	6579	93	2	1	2	6561	92	2	1	2	6186	87	2	1	2		
			Type III	UCM-[HOOD]-T3	6560	92	1	1	2	6542	92	1	1	2	6168	87	1	1	2		
			Type IV	UCM-[HOOD]-T4	6467	91	1	1	2	6449	91	1	1	2	6081	86	1	1	2		
			Type V	UCM-[HOOD]-T5	6623	93	3	1	2	6605	93	3	1	2	6227	88	3	1	2		
			Type IV, HSS	UCM-[HOOD]-T4-(...HSS)	4781	67	0	1	2	4768	67	0	1	2	4495	63	0	1	2		
		Clear Flat	Type II	UCM-[HOOD]-T2-(...CLR)	5836	82	2	1	2	5820	82	2	1	2	5487	77	2	1	2		
			Type III	UCM-[HOOD]-T3-(...CLR)	5819	82	1	1	2	5803	82	1	1	2	5471	77	1	1	2		
			Type IV	UCM-[HOOD]-T4-(...CLR)	5737	81	1	1	1	5721	81	1	1	1	5394	76	1	1	1		
			Type V	UCM-[HOOD]-T5-(...CLR)	5875	83	3	1	1	5859	83	3	1	1	5524	78	3	1	1		
			Type II	UCM-[HOOD]-T2-(...FLD)	4917	69	2	1	1	4904	69	2	1	1	4623	65	2	1	1		
		Diffused Flat	Type III	UCM-[HOOD]-T3-(...FLD)	4903	69	1	1	1	4889	69	1	1	1	4610	65	1	1	1		
			Type IV	UCM-[HOOD]-T4-(...FLD)	4833	68	1	1	1	4820	68	1	1	1	4544	64	1	1	1		
			Type V	UCM-[HOOD]-T5-(...FLD)	4950	70	2	0	1	4936	70	2	0	1	4654	66	2	0	1		
			Type II	UCM-WND-[HOOD]-T2	6713	91	2	1	2	6695	90	2	1	2	6312	85	2	1	2		
			Type III	UCM-WND-[HOOD]-T3	6694	90	1	1	2	6675	90	1	1	2	6294	85	1	1	2		
74	WND 4 Windows	(None)	Type IV	UCM-WND-[HOOD]-T4	6599	89	1	1	2	6581	89	1	1	2	6205	84	1	1	2		
			Type V	UCM-WND-[HOOD]-T5	6758	91	3	2	2	6739	91	3	2	2	6354	86	3	2	2		
			Type IV, HSS	UCM-WND-[HOOD]-T4-(...HSS)	4878	66	0	1	2	4865	66	0	1	2	4587	62	0	1	2		
			Type II	UCM-WND-[HOOD]-T2-(...CLR)	5955	80	2	1	2	5939	80	2	1	2	5599	76	2	1	2		
			Type III	UCM-WND-[HOOD]-T3-(...CLR)	5938	80	1	1	2	5922	80	1	1	2	5583	75	1	1	2		
		Clear Flat	Type IV	UCM-WND-[HOOD]-T4-(...CLR)	5854	79	1	1	2	5838	79	1	1	2	5504	74	1	1	2		
			Type V	UCM-WND-[HOOD]-T5-(...CLR)	5995	81	3	2	1	5979	81	3	2	1	5637	76	3	2	1		
			Type II	UCM-WND-[HOOD]-T2-(...FLD)	5017	68	2	1	1	5004	68	2	1	1	4718	64	2	1	1		
			Type III	UCM-WND-[HOOD]-T3-(...FLD)	5003	68	1	1	1	4989	67	1	1	1	4704	64	1	1	1		
			Type IV	UCM-WND-[HOOD]-T4-(...FLD)	4932	67	1	1	1	4918	66	1	1	1	4637	63	1	1	1		
		Diffused Flat	Type V	UCM-WND-[HOOD]-T5-(...FLD)	5051	68	2	2	1	5037	68	2	2	1	4749	64	2	2	1		
			Type II	UCM-SR-[HOOD]-T2	6610	89	2	1	2	6592	89	2	1	2	6215	84	2	1	2		
			Type III	UCM-SR-[HOOD]-T3	6591	89	1	0	2	6573	89	1	0	2	6197	84	1	0	2		
			Type IV	UCM-SR-[HOOD]-T4	6498	88	1	1	2	6480	88	1	1	2	6109	83	1	1	2		
			Type V	UCM-SR-[HOOD]-T5	6654	90	3	1	2	6636	90	3	1	2	6257	85	3	1	2		
74	SR Solid Rings	(None)	Type IV, HSS	UCM-SR-[HOOD]-T4-(...HSS)	4804	65	0	1	2	4790	65	0	1	2	4517	61	0	1	2		
			Type II	UCM-SR-[HOOD]-T2-(...CLR)	5864	79	2	1	2	5848	79	2	1	2	5513	75	2	1	2		
			Type III	UCM-SR-[HOOD]-T3-(...CLR)	5847	79	1	1	2	5831	79	1	1	2	5497	74	1	1	2		
			Type IV	UCM-SR-[HOOD]-T4-(...CLR)	5764	78	1	1	1	5748	78	1	1	1	5420	73	1	1	1		
			Type V	UCM-SR-[HOOD]-T5-(...CLR)	5903	80	3	1	1	5887	80	3	1	1	5550	75	3	1	1		
		Clear Flat	Type II	UCM-SR-[HOOD]-T2-(...FLD)	4940	67	2	1	1	4927	67	2	1	1	4645	63	2	1	1		
			Type III	UCM-SR-[HOOD]-T3-(...FLD)	4926	67	1	1	1	4913	66	1	1	1	4632	63	1	1	1		
			Type IV	UCM-SR-[HOOD]-T4-(...FLD)	4856	66	1	1	1	4843	65	1	1	1	4566	62	1	1	1		
			Type V	UCM-SR-[HOOD]-T5-(...FLD)	4973	67	2	1	1	4960	67	2	1	1	4676	63	2	1	1		
			Type II	UCM-VSL-[HOOD]-T2	6551	89	2	0	2	6533	88	2	0	2	6159	83	2	0	2		
		74	VSL Vertical Slots	(None)	Type III	UCM-VSL-[HOOD]-T3	6532	88	1	1	2	6514	88	1	1	2	6142	83	1	1	2
					Type IV	UCM-VSL-[HOOD]-T4	6439	87	1	1	2	6422	87	1	1	2	6055	82	1	1	2
					Type V	UCM-VSL-[HOOD]-T5	6595	89	3	1	2	6577	89	3	1	2	6201	84	3	1	2
					Type V, HSS	UCM-VSL-[HOOD]-T4-(...HSS)	4761	64	0	1	2	4748	64	0	1	2	4476	60	0	1	2
					Type II	UCM-VSL-[HOOD]-T2-(...CLR)	5811	79	2	1	2	5795	78	2	1	2	5464	74	2	1	2
Clear Flat	Type III			UCM-VSL-[HOOD]-T3-(...CLR)	5795	78	1	1	2	5779	78	1	1	2	5448	74	1	1	2		
	Type IV			UCM-VSL-[HOOD]-T4-(...CLR)	5712	77	1	1	1	5697	77	1	1	1	5371	73	1	1	1		
	Type V			UCM-VSL-[HOOD]-T5-(...CLR)	5850	79	3	1	1	5834	79	3	1	1	5501	74	3	1	1		
	Type II			UCM-VSL-[HOOD]-T2-(...FLD)	4604	62	2	1	1	4883	66	2	1	1	4896	66	2	1	1		
	Type III			UCM-VSL-[HOOD]-T3-(...FLD)	4590	62	1	1	1	4869	66	1	1	1	4882	66	1	1	1		
Diffused Flat	Type IV			UCM-VSL-[HOOD]-T4-(...FLD)	4525	61	1	1	1	4800	65	1	1	1	4813	65	1	1	1		
	Type V			UCM-VSL-[HOOD]-T5-(...FLD)	4634	63	2	1	1	4915	66	2	1	1	4929	67	2	1	1		
	Type II			UCM-LUM-[HOOD]-T2	6670	90	2	1	2	6652	90	2	1	2	6271	85	2	1	2		
	Type III			UCM-LUM-[HOOD]-T3	6651	90	1	0	2	6633	90	1	0	2	6253	85	1	0	2		
	Type IV			UCM-LUM-[HOOD]-T4	6557	89	1	1	2	6539	88	1	1	2	6165	83	1	1	2		
74	LUM Luminous Rings	(None)	Type V	UCM-LUM-[HOOD]-T5	6715	91	3	1	2	6696	90	3	1	2	6314	85	3	1	2		
			Type V, HSS	UCM-LUM-[HOOD]-T4-(...HSS)	4847	66	0	1	2	4834	65	0	1	2	4558	62	0	1	2		
			Type II	UCM-LUM-[HOOD]-T2-(...CLR)	5917	80	2	1	2	5901	80	2	1	2	5563	75	2	1	2		
			Type III	UCM-LUM-[HOOD]-T3-(...CLR)	5900	80	1	1	2	5883	80	1	1	2	5547	75	1	1	2		
			Type IV	UCM-LUM-[HOOD]-T4-(...CLR)	5816	79	1	1	2	5800	78	1	1	2	5468	74	1	1	2		
		Clear Flat	Type V	UCM-LUM-[HOOD]-T5-(...CLR)	5956	80	3	1	1	5940	80	3	1	1	5600	76	3	1	1		
			Type II	UCM-LUM-[HOOD]-T2-(...FLD)	4985	67	2	1	1	4971	67	2	1	1	4687	63	2	1	1		
			Type III	UCM-LUM-[HOOD]-T3-(...FLD)	4971	67	1	1	1	4957	67	1	1	1	4957	67	1	1	1		
			Type IV	UCM-LUM-[HOOD]-T4-(...FLD)	4900	66	1	1	1	4887	66	1	1	1	4607	62	1	1	1		
			Type V	UCM-LUM-[HOOD]-T5-(...FLD)	5018	68	2	1	1	5005	68	2	1	1	4719	64	2	1	1		



ARCHITECTURAL AREA LIGHTING
 17760 Rowland Street | City of Industry | CA 91748
 P 626.968.5666 | F 626.369.2695 | www.aal.net
 Copyright © 2014 March 7, 2017 2:58 PM

JOB	_____
TYPE	_____
NOTES	_____

LUMINAIRE PERFORMANCE (CONTINUED) Actual measured performance to be within +/-3% of the stated values

Configuration				Ordering Code	32LED-5K-700					32LED-4K-700					32LED-3K-700						
System Watts	Luminous Element	Lens	Distribution		Bright White (5000K)			Neutral White (4000K)			Warm White (3000K)										
					Delivered Lumens	Efficacy (Lm/W)	BUG Rating	Delivered Lumens	Efficacy (Lm/W)	BUG Rating	Delivered Lumens	Efficacy (Lm/W)	BUG Rating								
						B	U	G	B	U	G	B	U	G							
47	(None)	(None)	Type II	UCM-[HOOD]-T2	4844	103	2	0	2	4830	103	2	0	2	4607	98	2	0	2		
			Type III	UCM-[HOOD]-T3	4805	102	1	0	2	4791	102	1	0	2	4570	97	1	0	2		
			Type IV	UCM-[HOOD]-T4	4805	102	1	0	2	4791	102	1	0	2	4570	97	1	0	2		
			Type V	UCM-[HOOD]-T5	4839	103	3	0	1	4825	103	3	0	1	4602	98	3	0	1		
			Type IV, HSS	UCM-[HOOD]-T4- (...-HSS)	3539	75	0	0	2	3529	75	0	0	2	3327	71	0	0	2		
		Clear Flat	Type II	UCM-[HOOD]-T2- (...-CLR)	4180	89	1	1	1	4168	89	1	1	1	3976	85	1	1	1		
			Type III	UCM-[HOOD]-T3- (...-CLR)	4147	88	1	1	1	4135	88	1	1	1	3944	84	1	1	1		
			Type IV	UCM-[HOOD]-T4- (...-CLR)	4147	88	1	1	1	4135	88	1	1	1	3944	84	1	1	1		
			Type V	UCM-[HOOD]-T5- (...-CLR)	4176	89	2	0	1	4164	89	2	0	1	3972	85	2	0	1		
			Type II	UCM-[HOOD]-T2- (...-FLD)	3376	72	1	1	1	3367	72	1	1	1	3211	68	1	1	1		
		Diffused Flat	Type III	UCM-[HOOD]-T3- (...-FLD)	3349	71	1	1	1	3340	71	1	1	1	3185	68	1	1	1		
			Type IV	UCM-[HOOD]-T4- (...-FLD)	3349	71	1	1	1	3340	71	1	1	1	3185	68	1	1	1		
			Type V	UCM-[HOOD]-T5- (...-FLD)	3373	72	1	0	1	3363	72	1	0	1	3208	68	1	0	1		
			Type II	UCM-WND-[HOOD]-T2	4772	97	2	1	2	4758	97	2	1	2	4538	93	2	1	2		
			Type III	UCM-WND-[HOOD]-T3	4820	98	1	1	2	4806	98	1	1	2	4584	94	1	1	2		
49	WND 4 Windows	(None)	Type IV	UCM-WND-[HOOD]-T4	4792	98	1	1	2	4778	98	1	1	2	4558	93	1	1	2		
			Type V	UCM-WND-[HOOD]-T5	4783	98	3	2	2	4769	97	3	2	2	4549	93	3	2	2		
			Type IV, HSS	UCM-WND-[HOOD]-T4- (...-HSS)	3552	72	0	1	2	3542	72	0	1	2	3378	69	0	1	2		
			Type II	UCM-WND-[HOOD]-T2- (...-CLR)	4269	87	1	1	1	4256	87	1	1	1	4060	83	1	1	1		
			Type III	UCM-WND-[HOOD]-T3- (...-CLR)	4159	85	1	1	1	4147	85	1	1	1	3956	81	1	1	1		
		Clear Flat	Type IV	UCM-WND-[HOOD]-T4- (...-CLR)	3944	80	1	1	1	3932	80	1	1	1	3751	77	1	1	1		
			Type V	UCM-WND-[HOOD]-T5- (...-CLR)	4235	86	1	2	1	4223	86	1	2	1	4028	82	1	2	1		
			Type II	UCM-WND-[HOOD]-T2- (...-FLD)	3394	69	1	1	1	3384	69	1	1	1	3228	66	1	1	1		
			Type III	UCM-WND-[HOOD]-T3- (...-FLD)	3425	70	1	1	1	3415	70	1	1	1	3257	66	1	1	1		
			Type IV	UCM-WND-[HOOD]-T4- (...-FLD)	3335	68	1	1	1	3325	68	1	1	1	3171	65	1	1	1		
		Diffused Flat	Type V	UCM-WND-[HOOD]-T5- (...-FLD)	3450	70	2	1	1	3440	70	2	1	1	3281	67	2	1	1		
			Type II	UCM-SR-[HOOD]-T2	4716	96	2	1	2	4702	96	2	1	2	4485	92	2	1	2		
			Type III	UCM-SR-[HOOD]-T3	4763	97	1	1	2	4750	97	1	1	2	4530	92	1	1	2		
			Type IV	UCM-SR-[HOOD]-T4	4736	97	1	1	2	4722	96	1	1	2	4504	92	1	1	2		
			Type V	UCM-SR-[HOOD]-T5	4727	96	3	1	2	4713	96	3	1	2	4496	92	3	1	2		
49	SR Solid Rings	(None)	Type IV, HSS	UCM-SR-[HOOD]-T4- (...-HSS)	3537	72	0	1	2	3527	72	0	1	2	3364	69	0	1	2		
			Type II	UCM-SR-[HOOD]-T2- (...-CLR)	4785	98	1	1	1	4771	97	1	1	1	4551	93	1	1	1		
			Type III	UCM-SR-[HOOD]-T3- (...-CLR)	4663	95	1	1	1	4649	95	1	1	1	4435	91	1	1	1		
			Type IV	UCM-SR-[HOOD]-T4- (...-CLR)	4421	90	1	1	1	4408	90	1	1	1	4205	86	1	1	1		
			Type V	UCM-SR-[HOOD]-T5- (...-CLR)	4192	86	2	1	1	4180	85	2	1	1	3987	81	2	1	1		
		Clear Flat	Type II	UCM-SR-[HOOD]-T2- (...-FLD)	3364	69	1	1	1	3355	68	1	1	1	3200	65	1	1	1		
			Type III	UCM-SR-[HOOD]-T3- (...-FLD)	3395	69	1	1	1	3385	69	1	1	1	3229	66	1	1	1		
			Type IV	UCM-SR-[HOOD]-T4- (...-FLD)	3306	67	1	1	1	3296	67	1	1	1	3144	64	1	1	1		
			Type V	UCM-SR-[HOOD]-T5- (...-FLD)	3420	70	1	1	1	3410	70	1	1	1	3253	66	1	1	1		
			Type II	UCM-VSL-[HOOD]-T2	4725	96	2	0	2	4711	96	2	0	2	4494	92	2	0	2		
		49	VSL Vertical Slots	(None)	Type III	UCM-VSL-[HOOD]-T3	4772	97	1	1	2	4759	97	1	1	2	4539	93	1	1	2
					Type IV	UCM-VSL-[HOOD]-T4	4745	97	1	1	2	4731	97	1	1	2	4513	92	1	1	2
					Type V	UCM-VSL-[HOOD]-T5	4736	97	3	0	2	4722	96	3	0	2	4504	92	3	0	2
					Type IV, HSS	UCM-VSL-[HOOD]-T4- (...-HSS)	3562	73	0	1	2	3552	72	0	1	2	3388	69	0	1	2
					Type II	UCM-VSL-[HOOD]-T2- (...-CLR)	4223	86	1	1	1	4210	86	1	1	1	4016	82	1	1	1
Clear Flat	Type III			UCM-VSL-[HOOD]-T3- (...-CLR)	4114	84	1	1	1	4102	84	1	1	1	3913	80	1	1	1		
	Type IV			UCM-VSL-[HOOD]-T4- (...-CLR)	3901	80	1	1	1	3890	79	1	1	1	3710	76	1	1	1		
	Type V			UCM-VSL-[HOOD]-T5- (...-CLR)	4189	85	2	0	1	4177	85	2	0	1	3984	81	2	0	1		
	Type II			UCM-VSL-[HOOD]-T2- (...-FLD)	3367	69	1	1	1	3358	69	1	1	1	3203	65	1	1	1		
	Type III			UCM-VSL-[HOOD]-T3- (...-FLD)	3398	69	1	1	1	3388	69	1	1	1	3232	66	1	1	1		
Diffused Flat	Type IV			UCM-VSL-[HOOD]-T4- (...-FLD)	3308	68	1	1	1	3299	67	1	1	1	3147	64	1	1	1		
	Type V			UCM-VSL-[HOOD]-T5- (...-FLD)	3423	70	1	0	1	3413	70	1	0	1	3256	66	1	0	1		
	Type II			UCM-LUM-[HOOD]-T2	4809	98	2	1	2	4795	98	2	1	2	4574	93	2	1	2		
	Type III			UCM-LUM-[HOOD]-T3	4646	95	1	0	2	4633	95	1	0	2	4419	90	1	0	2		
	Type IV			UCM-LUM-[HOOD]-T4	4701	96	1	1	2	4687	96	1	1	2	4471	91	1	1	2		
49	LUM Luminous Rings	(None)	Type V	UCM-LUM-[HOOD]-T5	4733	97	3	1	1	4719	96	3	1	1	4502	92	3	1	1		
			Type V, HSS	UCM-LUM-[HOOD]-T4- (...-HSS)	3564	73	0	1	2	3554	73	0	1	2	3390	69	0	1	2		
			Type II	UCM-LUM-[HOOD]-T2- (...-CLR)	4207	86	1	1	1	4194	86	1	1	1	4001	82	1	1	1		
			Type III	UCM-LUM-[HOOD]-T3- (...-CLR)	4131	84	1	1	1	4119	84	1	1	1	3929	80	1	1	1		
			Type IV	UCM-LUM-[HOOD]-T4- (...-CLR)	3911	80	1	1	1	3900	80	1	1	1	3720	76	1	1	1		
		Clear Flat	Type V	UCM-LUM-[HOOD]-T5- (...-CLR)	4196	86	2	1	1	4184	85	2	1	1	3991	81	2	1	1		
			Type II	UCM-LUM-[HOOD]-T2- (...-FLD)	3434	70	1	1	1	3424	70	1	1	1	3266	67	1	1	1		
			Type III	UCM-LUM-[HOOD]-T3- (...-FLD)	3338	68	1	1	1	3328	68	1	1	1	3175	65	1	1	1		
			Type IV	UCM-LUM-[HOOD]-T4- (...-FLD)	3166	65	1	1	1	3157	64	1	1	1	3012	61	1	1	1		
			Type V	UCM-LUM-[HOOD]-T5- (...-FLD)	3418	70	1	1	1	3408	70	1	1	1	3251	66	1	1	1		



ARCHITECTURAL AREA LIGHTING
17760 Rowland Street | City of Industry | CA 91748
P 626.968.5666 | F 626.369.2695 | www.aal.net
Copyright © 2014 March 7, 2017 2:58 PM

JOB _____
TYPE _____
NOTES _____

ELECTRICAL CHARACTERISTICS

Ordering Code		Line Input		Amps AC	LED Drive (mA)	System Watts (w)	Min. Power Factor	MAX THD (%)	Driver Operating Temp. Range (°C)	Inrush Current peak		Dimming	
MODEL	LUMEN PACKAGE	VAC	Hz							(A)	T@ 50% (µs)	Dimming Range (V)	Source / Sink Current (mA)
UCM UCM-(...SLC)	700	120-277	50 / 60	0.6 - 0.3	650	71	≥9	20	-30 TO +40	15 - 32	100	0 - 10	1
		347		0.2						32	100		
		480		0.2						32	100		
UCM-WND UCM-SR UCM-VSL UCM-LUM	700	120-277	50 / 60	0.6 - 0.3	450	74	≥9	21	-30 TO +40	15 - 32	100	0 - 10	1
		347		0.2						32	100		
		480		0.2						32	100		
UCM UCM-(...SLC)	450	120-277	50 / 60	0.4	650	47	≥9	22	-30 TO +40	15 - 32	100	0 - 10	1
		347		0.1						32	100		
		480		0.1						32	100		
UCM-WND UCM-SR UCM-VSL UCM-LUM	450	120-277	50 / 60	0.2	450	49	≥9	23	-30 TO +40	15 - 32	100	0 - 10	1
		347		0.1						32	100		
		480		0.1						32	100		

ISOLINE TEMPLATES 16" Mounting Height

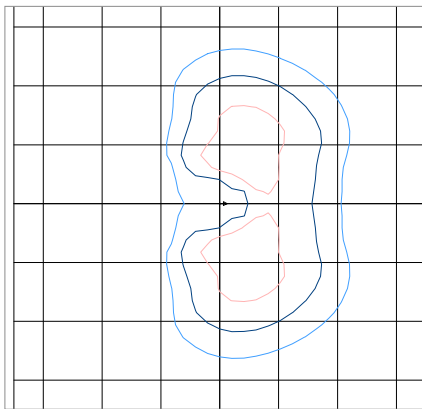

UCM-[HOOD]-T2-32LED-5K-700

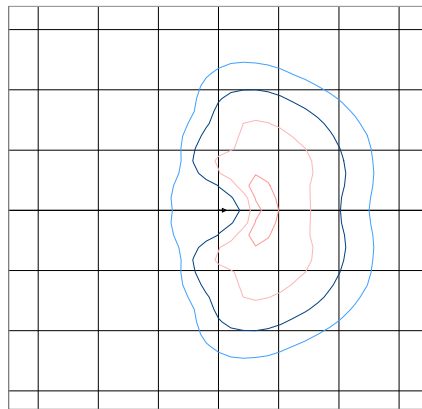

UCM-[HOOD]-T3-32LED-5K-700

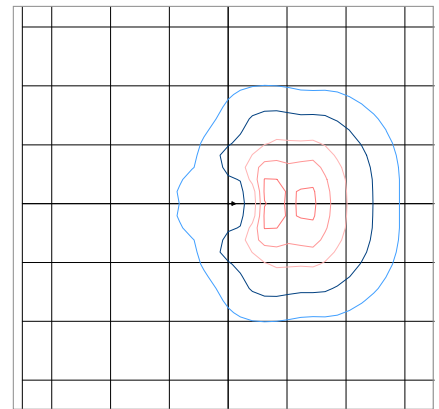

UCM-[HOOD]-T4-32LED-5K-700

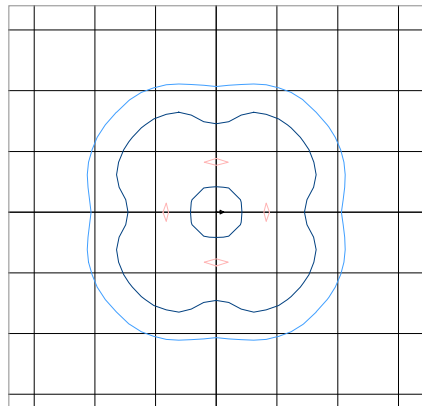
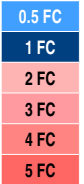

UCM-[HOOD]-T5-32LED-5K-700

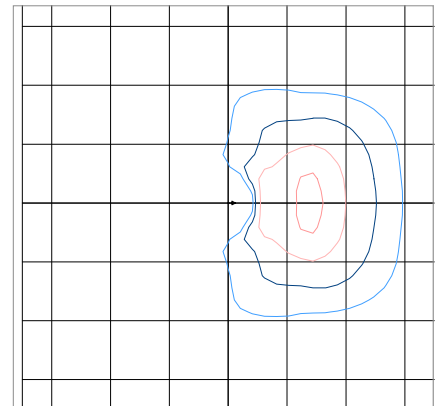

UCM-[HOOD]-T4-32LED-5K-700-HSS



ARCHITECTURAL AREA LIGHTING
 17760 Rowland Street | City of Industry | CA 91748
 P 626.968.5666 | F 626.369.2695 | www.aal.net
 Copyright © 2014 March 7, 2017 2:58 PM

JOB _____
 TYPE _____
 NOTES _____

TM-21 LIFETIME CALCULATION

Ambient Environment °C	Projected Lumen Maintenance (Khrs)					Reported L70
	15	25	50	60	100	
25	98%	97%	96%	96%	93%	>96Khrs.
40	96%	95%	93%	92%	89%	

DIMMING CURVE

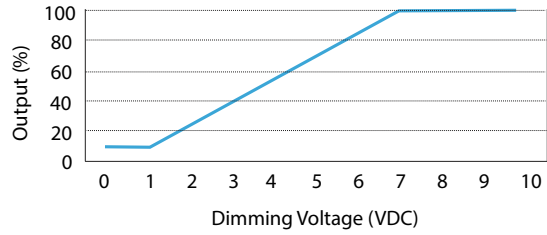

Note: Fixture does not dim to off, fixture dims to 10% minimum output.

COLOR CHARACTERISTICS

Value	Ordering Code		
	3K	4K	5K
Rf	69	69	71
Rg	99	99	98
CCT(K)	3122	3852	5020
Duv	0.001	0.0004	0.0005
CIE Ra	74	73	74

Note: TM-30 reported at the discrete LED level, not fixture level.

SPECTRAL POWER DISTRIBUTION COMPARISON

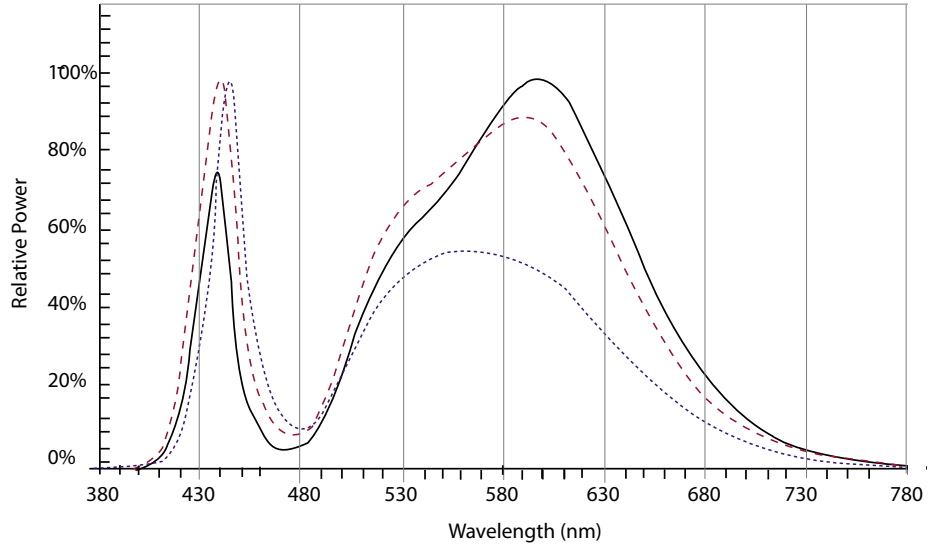

COLOR VECTOR GRAPHIC

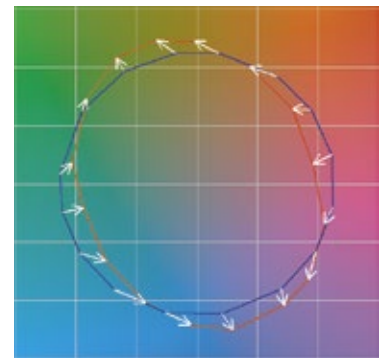
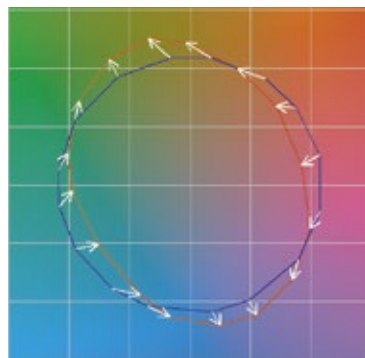
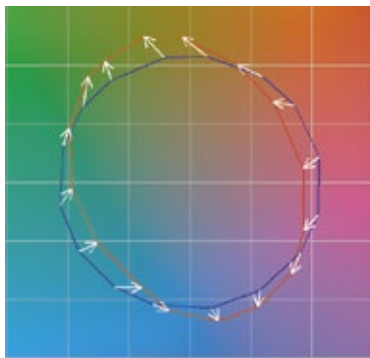

— Reference Illuminant — Test Source — Series1 — Series2
 — Series3 — Series4 — Series5 — Series6
 — Series7 — Series8 — Series9 — Series10

XX30

— Reference Illuminant — Test Source — Series1 — Series2
 — Series3 — Series4 — Series5 — Series6
 — Series7 — Series8 — Series9 — Series10

XX40

— Reference Illuminant — Test Source — Series1 — Series2
 — Series3 — Series4 — Series5 — Series6
 — Series7 — Series8 — Series9 — Series10

XX50

SENSOR DETECTION RANGE

		SENSOR MOUNTING HEIGHT											RATIO
		8'	10'	12'	14'	16'	18'	20'	25'	30'	35'	40'	
COVERAGE	SCP	20'	25'	30'	35'	40'	45'	50'	62.5'	75'	87.5'	100'	1:2.5
DIAMETER	WIRSC	16'	20'	24'	28'	32'	36'	50'	N/A	N/A	N/A	N/A	1:2

SPECIFICATIONS

HOUSING

- All housing components shall be die-cast aluminum 360 alloy, sealed with continuous silicone rubber gaskets.
- Hood and spacers shall be heavy gauge spun aluminum with hemmed edges for added rigidity.
- Luminous rings shall be clear acrylic with an internal lens.
- Standard configurations do not require a flat lens, optional lenses shall be tempered glass
- All internal and external hardware shall be stainless steel.
- Optical bezel finish shall match the luminaire housing.

OPTICAL

- Patent pending MicroCore™ LED modules shall independently aim each light emitting diode (LED) in both horizontal rotation and vertical tilt angle.
- LEDs shall be mounted to a metal printed circuit board assembly (PCBA) with a uniform conformal coating over the panel surface and electrical features.
- LED optics shall be clear injection molded PMMA acrylic.
- MicroCore™ PCBA and optic shall be sealed to a die-cast anodized aluminum heat sink with an injection molded silicone rubber gasket. IP66.
- Type 4 distribution with optional House Side Shield not available with clear or diffused glass lenses. Factory installed House Side Shield is optimized for Type 4 distribution and not recommended for use with Type 2 or 3 distribution and not available with type 5 distribution.

ELECTRICAL

- Luminaires shall have integral surge protection that shall be U.L. recognized and have a surge current rating of 10,000 Amps using the industry standard 8/20uSec wave and surge rating of 372J.
- Drivers shall be U.L. recognized with an inrush current maximum of <20.0 Amps maximum at 230VAC.
- Drivers shall not be compatible with current sourcing dimmers, consult factory for current list of known compatible dimming systems, approved dimmers include Lutron Diva AVTV, Lutron Nova NFTV and NTFTV.

CONTROLS

- Wireless enabled fixtures shall support bi-directional radio frequency (RF) communications utilizing IEEE 802.15.4 operating in the 2.4GHZ ISM band.
- Up to 1000' wireless range may be reduced by physical obstructions between fixtures.
- Motion sensor shall be flame retardant, UV resistant, impact resistant, recyclable polycarbonate.
- Motion Sensor shall use passive infrared (PIR) sensing technology that reacts to changes in infrared energy (moving body heat) within the coverage area. Careful consideration must be given to obstructions that may block the sensor's line of sight.
- Factory default settings for SCP option shall be:
 - High mode: 10V
 - Low mode: 1V
 - Ramp-up rate: disabled
 - Fade-down rate: disabled
 - Photocell: Off
 - Sensitivity: Full
 - Time Delay: Fade to low: 5 minutes
 - Time Delay: Fade to off: 1 hour

PHOTOCELL / EGRESS ADAPTERS

- Adapter(s) shall slip over a 4"/100mm DIA. pole with the luminaire or arm slipping over the adapter to add a total of 4.5"/114mm to the overall height. Adapter(s) shall be prewired, independently rotatable 359°, and have a cast access cover with an integral lens and lanyard.
- Photocell adapter shall include an internal twist lock receptacle. Photocell by others.
- Egress adapter shall require an auxiliary 120 volt supply for operation of an integral MR16 lamp in the event of emergency. The lamp may be aimed and locked into position with an adjustment range of 15°-45°. Adapter shall have a socket that accepts miniature bi-pin MR16 lamps up to 50 watts, lamp by others.

SERVICING

- Luminaire shall have tool-less service access to the gear compartment. Driver and surge suppressor shall be mounted to a prewired tray with quick disconnects that may be removed from the gear compartment.

ARM MOUNTING

- Luminaire shall be attached to the arm assembly with three stainless steel bolts. The connection shall be sealed with a silicone compression gasket.
- Post top arms and brackets shall slip over a 4"/100mm O.D. or a 5"/127mm as configured and secured with six stainless steel set screws.
- Wall mounted arms and brackets shall require mounting hardware by others.

FINISH

- Luminaire finish shall consist of a five stage pretreatment regimen with a polymer primer sealer, oven dry off, and top coated with a thermoset super TGIC polyester powder coat finish.
- Luminaire finish shall meet the AAMA 605.2 performance specification which includes passing a 3000 hour salt spray test for corrosion resistance.

CERTIFICATION

- Luminaire shall be listed with ETL for outdoor, wet location use, UL1598, UL 8750 and Canadian CSA Std. C22.2 no.250.

WARRANTY / TERMS AND CONDITIONS OF SALE

Download: <http://www.hubbelling.com/resources/warranty/>



JOB	_____
TYPE	_____
NOTES	_____

DLC QUALIFIED PRODUCTS

Lumen Package	Luminous Element	CCT	ANG – ANGLED HOOD		
			NO LENS Standard	FTG Flat clear glass lens	FLD Flat diffused glass lens
700	(None)	4K	UCM-ANG-T2-4K-32LED-700-120-277		
		4000K	UCM-ANG-T5-4K-32LED-700-120-277		
		5K	UCM-ANG-T2-5K-32LED-700-120-277		
		5000K	UCM-ANG-T3-5K-32LED-700-120-277		
		5000K	UCM-ANG-T5-5K-32LED-700-120-277		
450	(None)	3K 3000K	UCM-ANG-T2-3K-32LED-450-120-277		
			UCM-ANG-T3-3K-32LED-450-120-277		
			UCM-ANG-T4-3K-32LED-450-120-277		
			UCM-ANG-T5-3K-32LED-450-120-277		
			UCM-ANG-T2-4K-32LED-450-120-277		
		4K 4000K	UCM-ANG-T3-4K-32LED-450-120-277		
			UCM-ANG-T4-4K-32LED-450-120-277		
			UCM-ANG-T5-4K-32LED-450-120-277		
			UCM-ANG-T2-5K-32LED-450-120-277		
			UCM-ANG-T3-5K-32LED-450-120-277		
		5K 5000K	UCM-ANG-T4-5K-32LED-450-120-277		
			UCM-ANG-T5-5K-32LED-450-120-277		
			UCM-WND-ANG-T2-3K-32LED-450-120-277		
			UCM-WND-ANG-T3-3K-32LED-450-120-277		
			UCM-WND-ANG-T4-3K-32LED-450-120-277		
	WND 4 Windows	3K 3000K	UCM-WND-ANG-T5-3K-32LED-450-120-277		
			UCM-WND-ANG-T2-4K-32LED-450-120-277		
			UCM-WND-ANG-T3-4K-32LED-450-120-277		
			UCM-WND-ANG-T4-4K-32LED-450-120-277		
			UCM-WND-ANG-T5-4K-32LED-450-120-277		
		4K 4000K	UCM-WND-ANG-T2-5K-32LED-450-120-277		
			UCM-WND-ANG-T3-5K-32LED-450-120-277		
			UCM-WND-ANG-T4-5K-32LED-450-120-277		
			UCM-WND-ANG-T5-5K-32LED-450-120-277		
			UCM-SR-ANG-T2-3K-32LED-450-120-277	UCM-SR-ANG-T2-3K-32LED-450-FTG-120-277	
	SR Solid Rings	3K 3000K	UCM-SR-ANG-T3-3K-32LED-450-120-277	UCM-SR-ANG-T3-3K-32LED-450-FTG-120-277	
			UCM-SR-ANG-T4-3K-32LED-450-120-277		
			UCM-SR-ANG-T5-3K-32LED-450-120-277		
			UCM-SR-ANG-T2-4K-32LED-450-120-277	UCM-SR-ANG-T2-4K-32LED-450-FTG-120-277	
			UCM-SR-ANG-T3-4K-32LED-450-120-277	UCM-SR-ANG-T3-4K-32LED-450-FTG-120-277	
		4K 4000K	UCM-SR-ANG-T4-4K-32LED-450-120-277	UCM-SR-ANG-T4-4K-32LED-450-FTG-120-277	
			UCM-SR-ANG-T5-4K-32LED-450-120-277		
			UCM-SR-ANG-T2-5K-32LED-450-120-277	UCM-SR-ANG-T2-5K-32LED-450-FTG-120-277	
			UCM-SR-ANG-T3-5K-32LED-450-120-277	UCM-SR-ANG-T3-5K-32LED-450-FTG-120-277	
			UCM-SR-ANG-T4-5K-32LED-450-120-277	UCM-SR-ANG-T4-5K-32LED-450-FTG-120-277	
	VSL Vertical Slots	3K 3000K	UCM-SR-ANG-T5-5K-32LED-450-120-277		
			UCM-VSL-ANG-T2-3K-32LED-450-120-277		
			UCM-VSL-ANG-T3-3K-32LED-450-120-277		
			UCM-VSL-ANG-T4-3K-32LED-450-120-277		
			UCM-VSL-ANG-T5-3K-32LED-450-120-277		
		4K 4000K	UCM-VSL-ANG-T2-4K-32LED-450-120-277		
			UCM-VSL-ANG-T3-4K-32LED-450-120-277		
			UCM-VSL-ANG-T4-4K-32LED-450-120-277		
			UCM-VSL-ANG-T5-4K-32LED-450-120-277		
			UCM-VSL-ANG-T2-5K-32LED-450-120-277		
5K 5000K		UCM-VSL-ANG-T3-5K-32LED-450-120-277			
		UCM-VSL-ANG-T4-5K-32LED-450-120-277			
		UCM-VSL-ANG-T5-5K-32LED-450-120-277			
		UCM-LUM-ANG-T2-3K-32LED-450-120-277			
		UCM-LUM-ANG-T3-3K-32LED-450-120-277			
LUM Luminous Rings	3K 3000K	UCM-LUM-ANG-T4-3K-32LED-450-120-277			
		UCM-LUM-ANG-T5-3K-32LED-450-120-277			
		UCM-LUM-ANG-T2-4K-32LED-450-120-277			
		UCM-LUM-ANG-T3-4K-32LED-450-120-277			
		UCM-LUM-ANG-T4-4K-32LED-450-120-277			
	4K 4000K	UCM-LUM-ANG-T5-4K-32LED-450-120-277			
		UCM-LUM-ANG-T2-5K-32LED-450-120-277			
		UCM-LUM-ANG-T3-5K-32LED-450-120-277			
		UCM-LUM-ANG-T4-5K-32LED-450-120-277			
		UCM-LUM-ANG-T5-5K-32LED-450-120-277			



JOB	_____
TYPE	_____
NOTES	_____

DLC QUALIFIED PRODUCTS (Continued)

Lumen Package	Luminous Element	CCT	SKB – SKIRTED BELL HOOD		
			NO LENS Standard	FTG Flat clear glass lens	FLD Flat diffused glass lens
450	(None)	3K 3000K	UCM-SKB-T2-3K-32LED-450-120-277		
			UCM-SKB-T3-3K-32LED-450-120-277		
			UCM-SKB-T4-3K-32LED-450-120-277		
			UCM-SKB-T5-3K-32LED-450-120-277		
		4K 4000K	UCM-SKB-T2-4K-32LED-450-120-277		
			UCM-SKB-T3-4K-32LED-450-120-277		
			UCM-SKB-T4-4K-32LED-450-120-277		
			UCM-SKB-T5-4K-32LED-450-120-277		
		5K 5000K	UCM-SKB-T2-5K-32LED-450-120-277		
			UCM-SKB-T3-5K-32LED-450-120-277		
			UCM-SKB-T4-5K-32LED-450-120-277		
			UCM-SKB-T5-5K-32LED-450-120-277		
	WND 4 Windows	3K 3000K	UCM-WND-SKB-T2-3K-32LED-450-120-277		
			UCM-WND-SKB-T3-3K-32LED-450-120-277		
			UCM-WND-SKB-T4-3K-32LED-450-120-277		
			UCM-WND-SKB-T5-3K-32LED-450-120-277		
		4K 4000K	UCM-WND-SKB-T2-4K-32LED-450-120-277		
			UCM-WND-SKB-T3-4K-32LED-450-120-277		
			UCM-WND-SKB-T4-4K-32LED-450-120-277		
			UCM-WND-SKB-T5-4K-32LED-450-120-277		
		5K 5000K	UCM-WND-SKB-T2-5K-32LED-450-120-277		
			UCM-WND-SKB-T3-5K-32LED-450-120-277		
			UCM-WND-SKB-T4-5K-32LED-450-120-277		
			UCM-WND-SKB-T5-5K-32LED-450-120-277		
	SR Solid Rings	3K 3000K	UCM-SR-SKB-T3-3K-32LED-450-120-277		
			UCM-SR-SKB-T4-3K-32LED-450-120-277		
			UCM-SR-SKB-T5-3K-32LED-450-120-277		
			UCM-SR-SKB-T3-4K-32LED-450-120-277		
		4K 4000K	UCM-SR-SKB-T4-4K-32LED-450-120-277		
			UCM-SR-SKB-T5-4K-32LED-450-120-277		
			UCM-SR-SKB-T3-5K-32LED-450-120-277		
			UCM-SR-SKB-T4-5K-32LED-450-120-277		
		5K 5000K	UCM-SR-SKB-T5-5K-32LED-450-120-277		
			UCM-SR-SKB-T3-3K-32LED-450-120-277		
			UCM-SR-SKB-T4-3K-32LED-450-120-277		
			UCM-SR-SKB-T5-3K-32LED-450-120-277		
	VSL Vertical Slots	3K 3000K	UCM-VSL-SKB-T2-4K-32LED-450-120-277		
			UCM-VSL-SKB-T3-4K-32LED-450-120-277		
			UCM-VSL-SKB-T4-4K-32LED-450-120-277		
			UCM-VSL-SKB-T5-4K-32LED-450-120-277		
		4K 4000K	UCM-VSL-SKB-T3-5K-32LED-450-120-277		
			UCM-VSL-SKB-T4-5K-32LED-450-120-277		
			UCM-VSL-SKB-T5-5K-32LED-450-120-277		
			UCM-VSL-SKB-T3-3K-32LED-450-120-277		
		5K 5000K	UCM-VSL-SKB-T4-3K-32LED-450-120-277		
			UCM-VSL-SKB-T5-3K-32LED-450-120-277		
			UCM-VSL-SKB-T2-3K-32LED-450-120-277		
			UCM-VSL-SKB-T3-3K-32LED-450-120-277		
LUM Luminous Rings	3K 3000K	UCM-LUM-SKB-T2-3K-32LED-450-120-277			
		UCM-LUM-SKB-T3-3K-32LED-450-120-277			
		UCM-LUM-SKB-T4-3K-32LED-450-120-277			
		UCM-LUM-SKB-T5-3K-32LED-450-120-277			
	4K 4000K	UCM-LUM-SKB-T3-4K-32LED-450-120-277			
		UCM-LUM-SKB-T4-4K-32LED-450-120-277			
		UCM-LUM-SKB-T5-4K-32LED-450-120-277			
		UCM-LUM-SKB-T3-5K-32LED-450-120-277			
	5K 5000K	UCM-LUM-SKB-T4-5K-32LED-450-120-277			
		UCM-LUM-SKB-T5-5K-32LED-450-120-277			
		UCM-LUM-SKB-T2-4K-32LED-450-120-277			
		UCM-LUM-SKB-T3-4K-32LED-450-120-277			



JOB	_____
TYPE	_____
NOTES	_____

DLC QUALIFIED PRODUCTS (Continued)

Lumen Package	Luminous Element	CCT	BEL – BELL HOOD		
			NO LENS Standard	FTG Flat clear glass lens	FLD Flat diffused glass lens
700	(None)	4K 4000K	UCM-BEL-T2-4K-32LED-700-120-277		
			UCM-BEL-T3-4K-32LED-700-120-277		
			UCM-BEL-T4-4K-32LED-700-120-277		
			UCM-BEL-T5-4K-32LED-700-120-277		
		5K 5000K	UCM-BEL-T2-5K-32LED-700-120-277		
			UCM-BEL-T3-5K-32LED-700-120-277		
			UCM-BEL-T4-5K-32LED-700-120-277		
			UCM-BEL-T5-5K-32LED-700-120-277		
	WND 4 Windows	4K	UCM-WND-BEL-T5-4K-32LED-700-120-277		
		5K	UCM-WND-BEL-T5-5K-32LED-700-120-277		
450	(None)	3K 3000K	UCM-BEL-T2-3K-32LED-450-120-277		
			UCM-BEL-T3-3K-32LED-450-120-277		
			UCM-BEL-T4-3K-32LED-450-120-277		
			UCM-BEL-T5-3K-32LED-450-120-277		
		4K 4000K	UCM-BEL-T2-4K-32LED-450-120-277		
			UCM-BEL-T3-4K-32LED-450-120-277		
			UCM-BEL-T4-4K-32LED-450-120-277		
			UCM-BEL-T5-4K-32LED-450-120-277		
		5K 5000K	UCM-BEL-T2-5K-32LED-450-120-277		
			UCM-BEL-T3-5K-32LED-450-120-277		
			UCM-BEL-T4-5K-32LED-450-120-277		
			UCM-BEL-T5-5K-32LED-450-120-277		
	WND 4 Windows	3K 3000K	UCM-WND-BEL-T2-3K-32LED-450-120-277		
			UCM-WND-BEL-T3-3K-32LED-450-120-277		
			UCM-WND-BEL-T4-3K-32LED-450-120-277		
			UCM-WND-BEL-T5-3K-32LED-450-120-277		
		4K 4000K	UCM-WND-BEL-T2-4K-32LED-450-120-277		
			UCM-WND-BEL-T3-4K-32LED-450-120-277		
			UCM-WND-BEL-T4-4K-32LED-450-120-277		
			UCM-WND-BEL-T5-4K-32LED-450-120-277		
		5K 5000K	UCM-WND-BEL-T2-5K-32LED-450-120-277		
			UCM-WND-BEL-T3-5K-32LED-450-120-277		
			UCM-WND-BEL-T4-5K-32LED-450-120-277		
			UCM-WND-BEL-T5-5K-32LED-450-120-277		
	SR Solid Rings	3K 3000K	UCM-SR-BEL-T2-3K-32LED-450-120-277		
			UCM-SR-BEL-T3-3K-32LED-450-120-277		
			UCM-SR-BEL-T4-3K-32LED-450-120-277		
			UCM-SR-BEL-T5-3K-32LED-450-120-277		
		4K 4000K	UCM-SR-BEL-T2-4K-32LED-450-120-277		
			UCM-SR-BEL-T3-4K-32LED-450-120-277		
			UCM-SR-BEL-T4-4K-32LED-450-120-277		
			UCM-SR-BEL-T5-4K-32LED-450-120-277		
		5K 5000K	UCM-SR-BEL-T2-5K-32LED-450-120-277		
			UCM-SR-BEL-T3-5K-32LED-450-120-277		
			UCM-SR-BEL-T4-5K-32LED-450-120-277		
			UCM-SR-BEL-T5-5K-32LED-450-120-277		
	VSL Vertical Slots	3K 3000K	UCM-VSL-BEL-T2-3K-32LED-450-120-277		
			UCM-VSL-BEL-T3-3K-32LED-450-120-277		
			UCM-VSL-BEL-T4-3K-32LED-450-120-277		
			UCM-VSL-BEL-T5-3K-32LED-450-120-277		
4K 4000K		UCM-VSL-BEL-T2-4K-32LED-450-120-277			
		UCM-VSL-BEL-T3-4K-32LED-450-120-277			
		UCM-VSL-BEL-T4-4K-32LED-450-120-277			
		UCM-VSL-BEL-T5-4K-32LED-450-120-277			
5K 5000K		UCM-VSL-BEL-T2-5K-32LED-450-120-277			
		UCM-VSL-BEL-T3-5K-32LED-450-120-277			
		UCM-VSL-BEL-T4-5K-32LED-450-120-277			
		UCM-VSL-BEL-T5-5K-32LED-450-120-277			
LUM Luminous Rings	3K 3000K	UCM-LUM-BEL-T2-3K-32LED-450-120-277			
		UCM-LUM-BEL-T3-3K-32LED-450-120-277			
		UCM-LUM-BEL-T4-3K-32LED-450-120-277			
		UCM-LUM-BEL-T5-3K-32LED-450-120-277			
	4K 4000K	UCM-LUM-BEL-T2-4K-32LED-450-120-277			
		UCM-LUM-BEL-T3-4K-32LED-450-120-277			
		UCM-LUM-BEL-T4-4K-32LED-450-120-277			
		UCM-LUM-BEL-T5-4K-32LED-450-120-277			
	5K 5000K	UCM-LUM-BEL-T2-5K-32LED-450-120-277			
		UCM-LUM-BEL-T3-5K-32LED-450-120-277			
		UCM-LUM-BEL-T4-5K-32LED-450-120-277			
		UCM-LUM-BEL-T5-5K-32LED-450-120-277			



ARCHITECTURAL AREA LIGHTING
 17760 Rowland Street | City of Industry | CA 91748
 P 626.968.5666 | F 626.369.2695 | www.aal.net
 Copyright © 2014 March 7, 2017 2:58 PM

JOB	_____
TYPE	_____
NOTES	_____

DLC QUALIFIED PRODUCTS (Continued)

Lumen Package	Luminous Element	CCT	FLR – FLARED HOOD		
			NO LENS Standard	FTG Flat clear glass lens	FLD Flat diffused glass lens
450	(None)	3K 3000K	UCM-FLR-T2-3K-32LED-450-120-277		
			UCM-FLR-T3-3K-32LED-450-120-277		
			UCM-FLR-T4-3K-32LED-450-120-277		
			UCM-FLR-T5-3K-32LED-450-120-277		
		4K 4000K	UCM-FLR-T2-4K-32LED-450-120-277		
			UCM-FLR-T3-4K-32LED-450-120-277		
			UCM-FLR-T4-4K-32LED-450-120-277		
			UCM-FLR-T5-4K-32LED-450-120-277		
		5K 5000K	UCM-FLR-T2-5K-32LED-450-120-277		
			UCM-FLR-T3-5K-32LED-450-120-277		
			UCM-FLR-T4-5K-32LED-450-120-277		
			UCM-FLR-T5-5K-32LED-450-120-277		
	WND 4 Windows	3K 3000K	UCM-WND-FLR-T2-3K-32LED-450-120-277		
			UCM-WND-FLR-T3-3K-32LED-450-120-277		
			UCM-WND-FLR-T4-3K-32LED-450-120-277		
			UCM-WND-FLR-T5-3K-32LED-450-120-277		
		4K 4000K	UCM-WND-FLR-T2-4K-32LED-450-120-277		
			UCM-WND-FLR-T3-4K-32LED-450-120-277		
			UCM-WND-FLR-T4-4K-32LED-450-120-277		
			UCM-WND-FLR-T5-4K-32LED-450-120-277		
		5K 5000K	UCM-WND-FLR-T2-5K-32LED-450-120-277		
			UCM-WND-FLR-T3-5K-32LED-450-120-277		
			UCM-WND-FLR-T4-5K-32LED-450-120-277		
			UCM-WND-FLR-T5-5K-32LED-450-120-277		
	VSL Vertical Slots	3K 3000K	UCM-SR-FLR-T3-3K-32LED-450-120-277		
			UCM-SR-FLR-T4-3K-32LED-450-120-277		
			UCM-SR-FLR-T5-3K-32LED-450-120-277		
			UCM-SR-FLR-T2-4K-32LED-450-120-277		
		4K 4000K	UCM-SR-FLR-T3-4K-32LED-450-120-277		
			UCM-SR-FLR-T4-4K-32LED-450-120-277		
			UCM-SR-FLR-T5-4K-32LED-450-120-277		
			UCM-SR-FLR-T2-5K-32LED-450-120-277		
		5K 5000K	UCM-SR-FLR-T3-5K-32LED-450-120-277		
			UCM-SR-FLR-T4-5K-32LED-450-120-277		
			UCM-SR-FLR-T5-5K-32LED-450-120-277		
			UCM-VSL-FLR-T2-3K-32LED-450-120-277		
	LUM Luminous Rings	3K 3000K	UCM-VSL-FLR-T3-3K-32LED-450-120-277		
			UCM-VSL-FLR-T4-3K-32LED-450-120-277		
			UCM-VSL-FLR-T5-3K-32LED-450-120-277		
			UCM-VSL-FLR-T2-4K-32LED-450-120-277		
		4K 4000K	UCM-VSL-FLR-T3-4K-32LED-450-120-277		
			UCM-VSL-FLR-T4-4K-32LED-450-120-277		
			UCM-VSL-FLR-T5-4K-32LED-450-120-277		
			UCM-VSL-FLR-T2-5K-32LED-450-120-277		
		5K 5000K	UCM-VSL-FLR-T3-5K-32LED-450-120-277		
			UCM-VSL-FLR-T4-5K-32LED-450-120-277		
			UCM-VSL-FLR-T5-5K-32LED-450-120-277		
			UCM-LUM-FLR-T2-3K-32LED-450-120-277		
	3K 3000K	UCM-LUM-FLR-T4-3K-32LED-450-120-277			
		UCM-LUM-FLR-T5-3K-32LED-450-120-277			
		UCM-LUM-FLR-T2-4K-32LED-450-120-277			
		UCM-LUM-FLR-T4-4K-32LED-450-120-277			
	4K 4000K	UCM-LUM-FLR-T5-4K-32LED-450-120-277			
		UCM-LUM-FLR-T2-5K-32LED-450-120-277			
		UCM-LUM-FLR-T3-5K-32LED-450-120-277			
		UCM-LUM-FLR-T4-5K-32LED-450-120-277			
	5K 5000K	UCM-LUM-FLR-T5-5K-32LED-450-120-277			



JOB	_____
TYPE	_____
NOTES	_____

DLC QUALIFIED PRODUCTS (Continued)

Lumen Package	Luminous Element	CCT	STR – STRAIGHT HOOD			
			NO LENS Standard	FTG Flat clear glass lens	FLD Flat diffused glass lens	
700	(None)	4K 4000K	UCM-STR-T2-4K-32LED-700-120-277			
			UCM-STR-T3-4K-32LED-700-120-277			
			UCM-STR-T4-4K-32LED-700-120-277			
		5K 5000K	UCM-STR-T5-4K-32LED-700-120-277			
			UCM-STR-T2-5K-32LED-700-120-277			
			UCM-STR-T3-5K-32LED-700-120-277			
	WND 4 Windows	4K 4000K	UCM-WND-STR-T2-4K-32LED-700-120-277			
			UCM-WND-STR-T3-4K-32LED-700-120-277			
		5K 5000K	UCM-WND-STR-T5-4K-32LED-700-120-277			
			UCM-WND-STR-T2-5K-32LED-700-120-277			
	450	(None)	3K 3000K	UCM-STR-T2-3K-32LED-450-120-277		
				UCM-STR-T3-3K-32LED-450-120-277		
				UCM-STR-T4-3K-32LED-450-120-277		
			4K 4000K	UCM-STR-T5-3K-32LED-450-120-277		
UCM-STR-T2-4K-32LED-450-120-277						
UCM-STR-T3-4K-32LED-450-120-277						
WND 4 Windows			5K 5000K	UCM-STR-T4-4K-32LED-450-120-277		
				UCM-STR-T5-4K-32LED-450-120-277		
				UCM-STR-T2-5K-32LED-450-120-277		
			3K 3000K	UCM-WND-STR-T2-3K-32LED-450-120-277		
				UCM-WND-STR-T3-3K-32LED-450-120-277		
				UCM-WND-STR-T4-3K-32LED-450-120-277		
SR Solid Rings		4K 4000K	UCM-WND-STR-T5-3K-32LED-450-120-277			
			UCM-WND-STR-T2-4K-32LED-450-120-277	UCM-WND-STR-T2-4K-32LED-450-FTG-120-277		
			UCM-WND-STR-T3-4K-32LED-450-120-277			
		5K 5000K	UCM-WND-STR-T4-4K-32LED-450-120-277			
			UCM-WND-STR-T5-4K-32LED-450-120-277	UCM-WND-STR-T5-4K-32LED-450-FTG-120-277		
			UCM-WND-STR-T2-5K-32LED-450-120-277	UCM-WND-STR-T2-5K-32LED-450-FTG-120-277		
VSL Vertical Slots		3K 3000K	UCM-WND-STR-T3-5K-32LED-450-120-277			
			UCM-WND-STR-T4-5K-32LED-450-120-277			
			UCM-WND-STR-T5-5K-32LED-450-120-277	UCM-WND-STR-T3-5K-32LED-450-FTG-120-277		
		LUM Luminous Rings	4K 4000K	UCM-WND-STR-T2-5K-32LED-450-120-277		
				UCM-WND-STR-T3-5K-32LED-450-120-277		
				UCM-WND-STR-T4-5K-32LED-450-120-277		
			5K 5000K	UCM-WND-STR-T5-5K-32LED-450-120-277	UCM-WND-STR-T5-5K-32LED-450-FTG-120-277	
				UCM-SR-STR-T2-3K-32LED-450-120-277		
				UCM-SR-STR-T3-3K-32LED-450-120-277		
		LUM Luminous Rings	3K 3000K	UCM-SR-STR-T4-3K-32LED-450-120-277		
				UCM-SR-STR-T5-3K-32LED-450-120-277		
				UCM-SR-STR-T2-4K-32LED-450-120-277		
4K 4000K			UCM-SR-STR-T3-4K-32LED-450-120-277			
			UCM-SR-STR-T4-4K-32LED-450-120-277			
			UCM-SR-STR-T5-4K-32LED-450-120-277			
LUM Luminous Rings			5K 5000K	UCM-SR-STR-T2-5K-32LED-450-120-277		
				UCM-SR-STR-T3-5K-32LED-450-120-277		
				UCM-SR-STR-T4-5K-32LED-450-120-277		
	3K 3000K		UCM-SR-STR-T5-5K-32LED-450-120-277			
			UCM-VSL-STR-T2-3K-32LED-450-120-277			
			UCM-VSL-STR-T3-3K-32LED-450-120-277			
LUM Luminous Rings	4K 4000K	UCM-VSL-STR-T4-3K-32LED-450-120-277				
		UCM-VSL-STR-T5-3K-32LED-450-120-277				
		UCM-VSL-STR-T2-4K-32LED-450-120-277				
	5K 5000K	UCM-VSL-STR-T3-4K-32LED-450-120-277				
		UCM-VSL-STR-T4-4K-32LED-450-120-277				
		UCM-VSL-STR-T5-4K-32LED-450-120-277				
LUM Luminous Rings	5K 5000K	UCM-VSL-STR-T2-5K-32LED-450-120-277				
		UCM-VSL-STR-T3-5K-32LED-450-120-277				
		UCM-VSL-STR-T4-5K-32LED-450-120-277				
	3K 3000K	UCM-VSL-STR-T5-5K-32LED-450-120-277				
		UCM-LUM-STR-T2-3K-32LED-450-120-277				
		UCM-LUM-STR-T3-3K-32LED-450-120-277				
LUM Luminous Rings	4K 4000K	UCM-LUM-STR-T4-3K-32LED-450-120-277				
		UCM-LUM-STR-T5-3K-32LED-450-120-277				
		UCM-LUM-STR-T2-4K-32LED-450-120-277				
	5K 5000K	UCM-LUM-STR-T3-4K-32LED-450-120-277				
		UCM-LUM-STR-T4-4K-32LED-450-120-277				
		UCM-LUM-STR-T5-4K-32LED-450-120-277				
LUM Luminous Rings	5K 5000K	UCM-LUM-STR-T2-5K-32LED-450-120-277				
		UCM-LUM-STR-T3-5K-32LED-450-120-277				
		UCM-LUM-STR-T4-5K-32LED-450-120-277				
	3K 3000K	UCM-LUM-STR-T5-5K-32LED-450-120-277				
		UCM-LUM-STR-T2-3K-32LED-450-120-277				
		UCM-LUM-STR-T3-3K-32LED-450-120-277				



ARCHITECTURAL AREA LIGHTING
 17760 Rowland Street | City of Industry | CA 91748
 P 626.968.5666 | F 626.369.2695 | www.aal.net
 Copyright © 2014 March 7, 2017 2:58 PM

JOB	_____
TYPE	_____
NOTES	_____

Universe® Collection Medium LED – UCM

TYPE

SLA3

WT: 8 LBS

EPA: .77

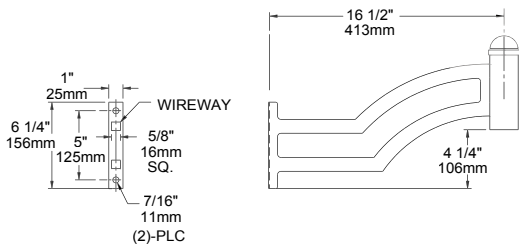

4" POLE

SLA3

WT: 8 LBS

EPA: .77

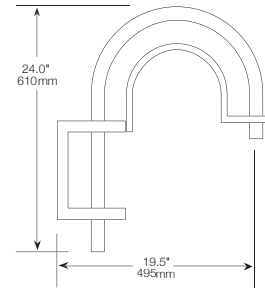

4" POLE

SLA4

WT: 14 LBS

EPA: 1.39

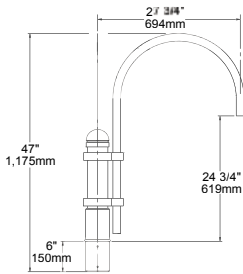

4" POLE

SLA4-2

WT: 26 LBS

EPA: 2.10

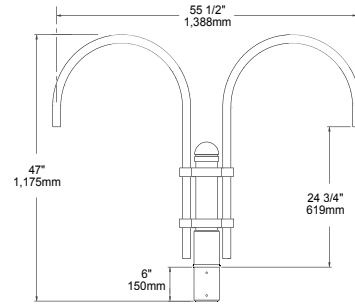

4" POLE

SLA7

WT: 9 LBS

EPA: 1.34

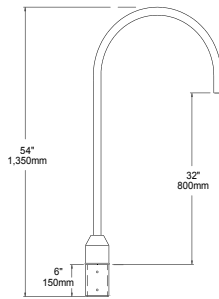

4" POLE

SLA7-2

WT: 16 LBS

EPA: 2.34

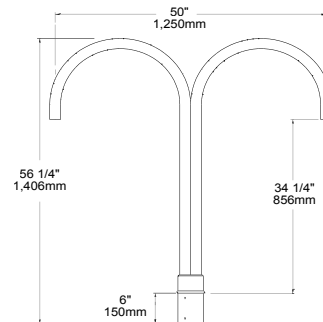

4" POLE

SLA7 (5)

WT: 11 LBS

EPA: 1.73

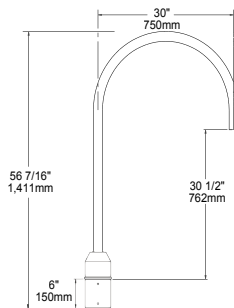

5" POLE

SLA7 (5)-2

WT: 18 LBS

EPA: 2.60

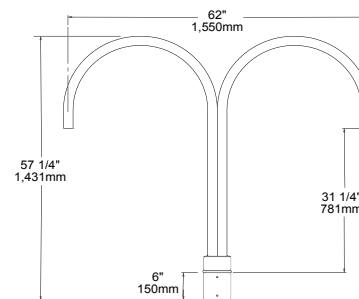

5" POLE



ARCHITECTURAL AREA LIGHTING
17760 Rowland Street | City of Industry | CA 91748
P 626.968.5666 | F 626.369.2695 | www.aal.net
Copyright © 2014 March 7, 2017 2:58 PM

JOB _____
TYPE _____
NOTES _____

SLA8D

WT: 5 LBS

EPA: .40

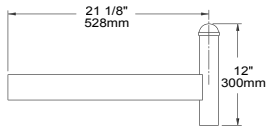

4" OR 5" POLE

SLA9

WT: 18 LBS

EPA: 1.90

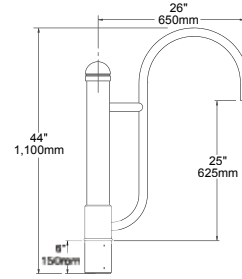

4" POLE

SLA9-2

WT: 24 LBS

EPA: 2.44

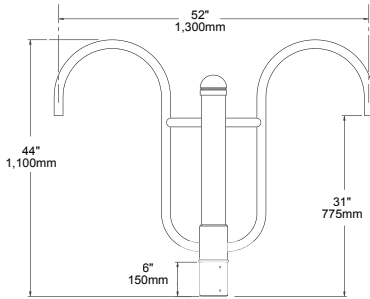

4" POLE

SLA10

WT: 9 LBS

EPA: 1.09

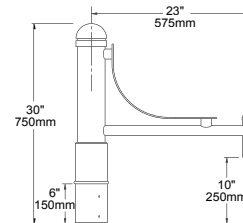

4" POLE

SLA10-2

WT: 16 LBS

EPA: 1.47

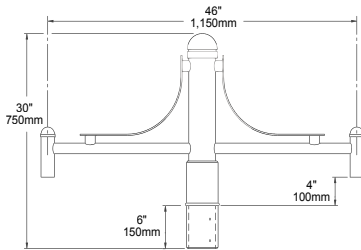

4" POLE

SLA16

WT: 18 LBS

EPA: 2.88

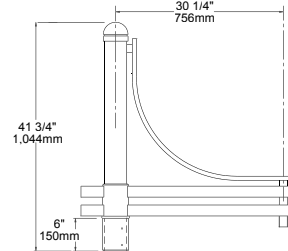

4" POLE

SLA16-2

WT: 28 LBS

EPA: 4.38

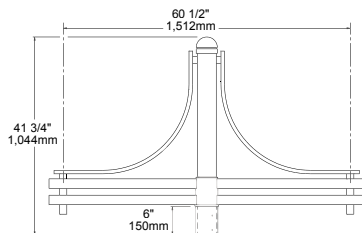

4" POLE

SLA17

WT: 18 LBS

EPA: 1.50

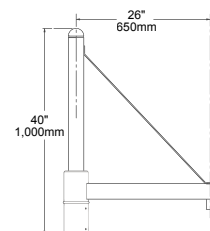

4" POLE

SLA17-2

WT: 24 LBS

EPA: 2.05

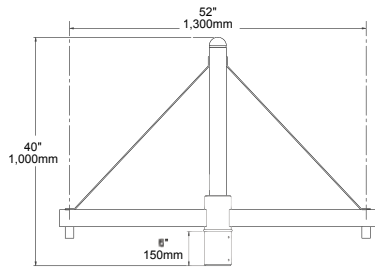

4" POLE

SLA17 (5)

WT: 24 LBS

EPA: 2.20

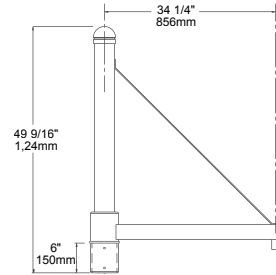

5" POLE

SLA17 (5)-2

WT: 33 LBS

EPA: 2.90

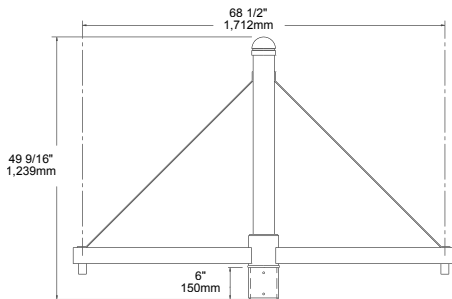

5" POLE

SLA18

WT: 12 LBS

EPA: .85

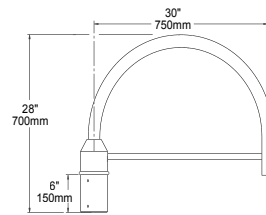

4" POLE

SLA18-2

WT: 22 LBS

EPA: 1.59

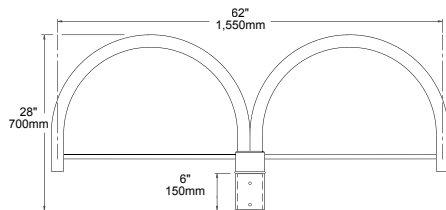

4" POLE

SLA20

WT: 10 LBS

EPA: .70

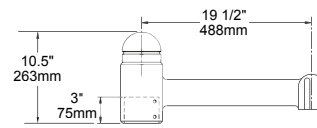

4" POLE

SLA20-2

WT: 18 LBS

EPA: 1.25

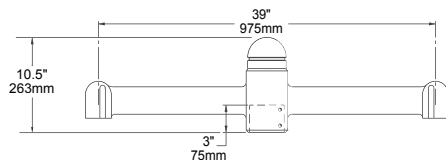

4" POLE

SLA20A

WT: 15 LBS

EPA: 1.30

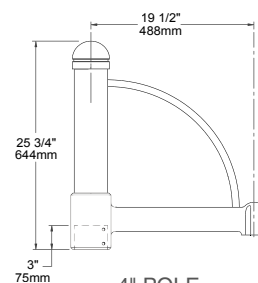

4" POLE



ARCHITECTURAL AREA LIGHTING
 17760 Rowland Street | City of Industry | CA 91748
 P 626.968.5666 | F 626.369.2695 | www.aal.net
 Copyright © 2014 March 7, 2017 2:58 PM

JOB _____
 TYPE _____
 NOTES _____

SLA20A-2 WT: 26 LBS EPA: 1.94

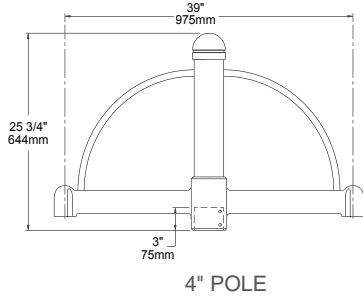

SLA20B WT: 14 LBS EPA: 1.40

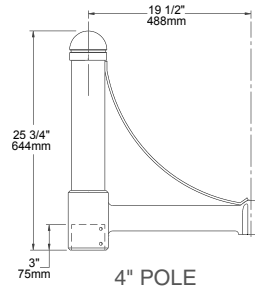

SLA20B-2 WT: 24 LBS EPA: 1.70

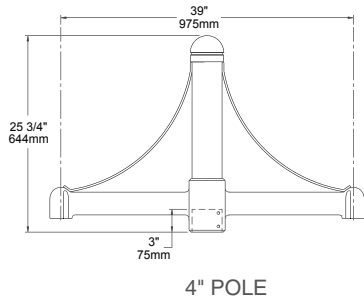

SLA20C WT: 15 LBS EPA: 1.39

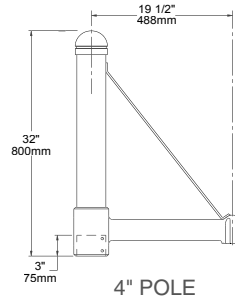

SLA20C-2 WT: 26 LBS EPA: 1.91

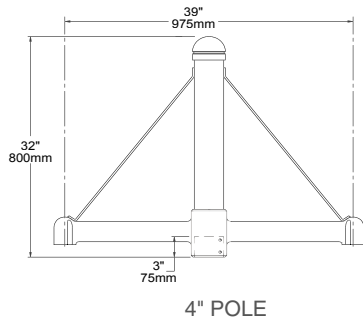

SLA20D WT: 12 LBS EPA: .75

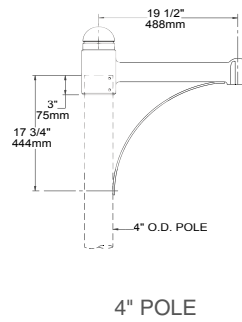

SLA20D-2 WT: 21 LBS EPA: 1.18

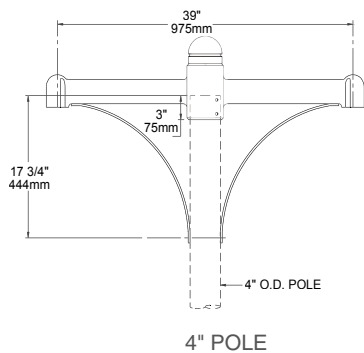

SLA22D WT: 4 LBS EPA: .44

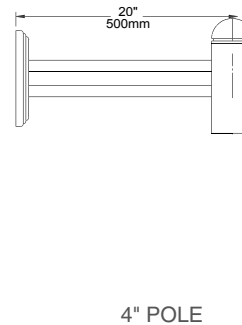

SLA24

WT: 9 LBS

EPA: .85

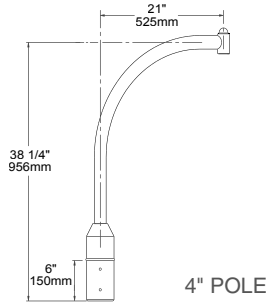

SLA24-2

WT: 14 LBS

EPA: 1.59

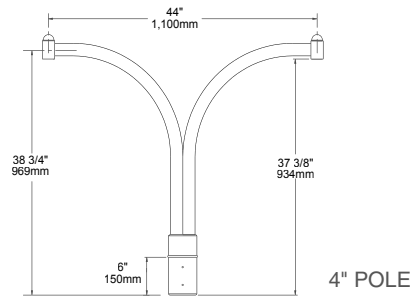

SLA24(5)

WT: 11 LBS

EPA: 1.17

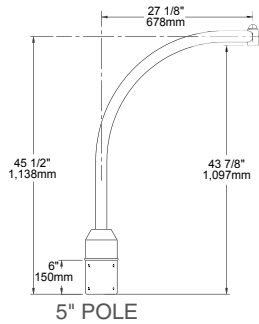

SLA24(5)-2

WT: 16 LBS

EPA: 1.81

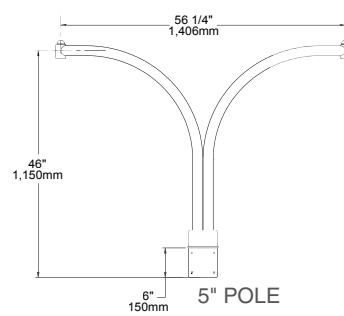

TRA4

WT: 16 LBS

EPA: 1.81

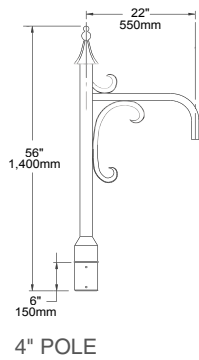

TRA7

WT: 12 LBS

EPA: .90

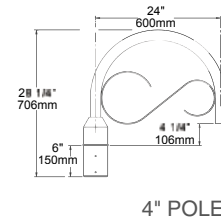

TRA7-2

WT: 18 LBS

EPA: 1.62

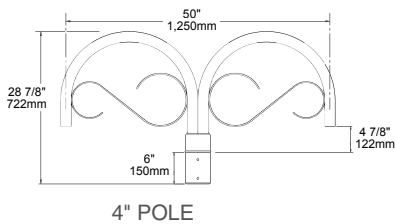

TRA8

WT: 13 LBS

EPA: 1.34

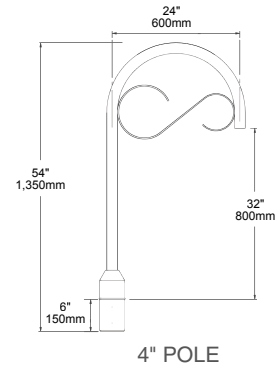

TRA8-2

WT: 21 LBS EPA: 2.68

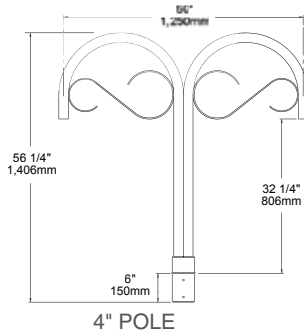

TRA9

WT: 17 LBS EPA: 1.90

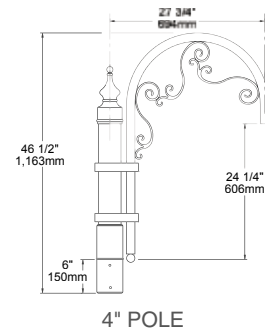

TRA9-2

WT: 25 LBS EPA: 2.72

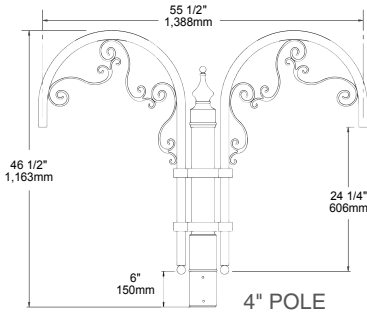

WMA4

WT: 12 LBS

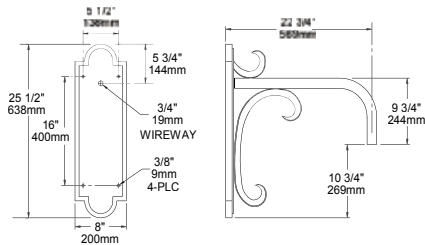

WMA5

WT: 6 LBS

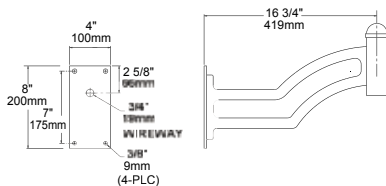

WMA6

WT: 14 LBS

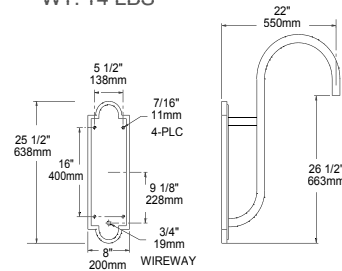

WMA8

WT: 10 LBS

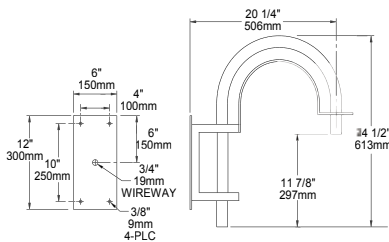

WMA9D

WT: 6 LBS

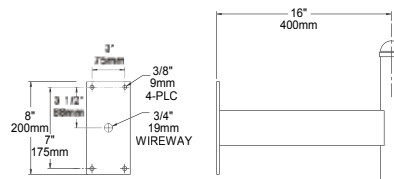

WMA10 WT: 16 LBS

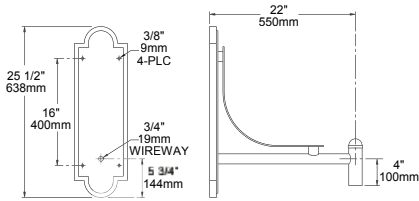

WMA11 WT: 10 LBS

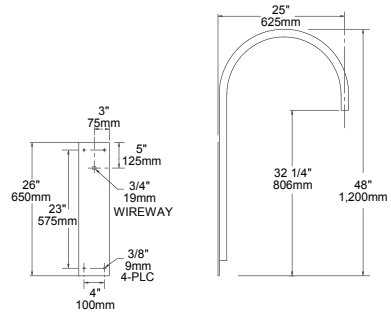

WMA12 WT: 12 LBS

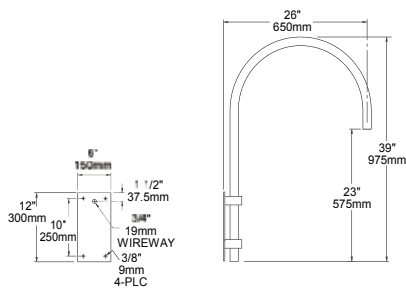

WMA16 WT: 22 LBS

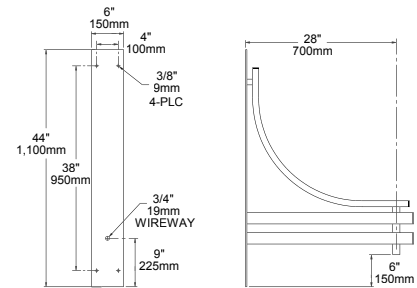

WMA17 WT: 15 LBS

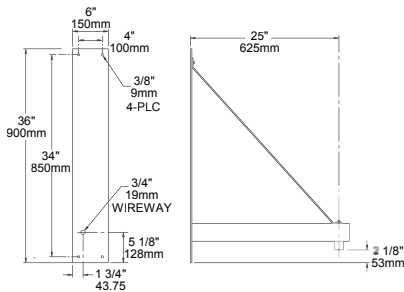

WMA18 WT: 18 LBS

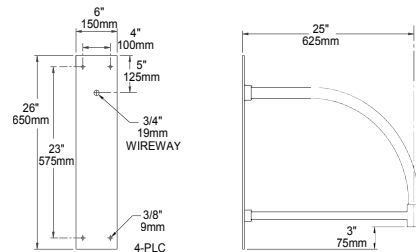

WMA20 WT: 12 LBS

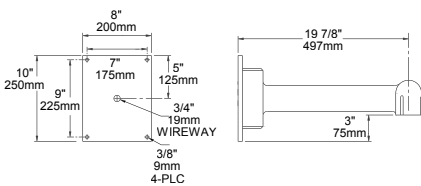

WMA22D WT: 4 LBS

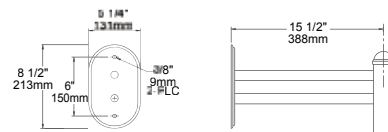

WMA24

WT: 12 LBS

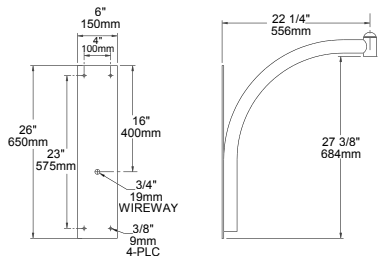

WMA37

WT: 12 LBS

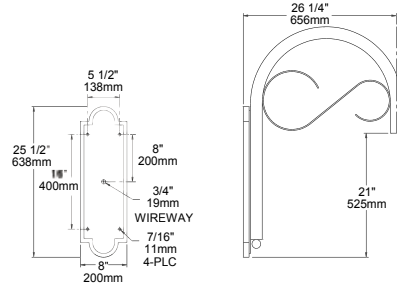

WMA38

WT: 12 LBS

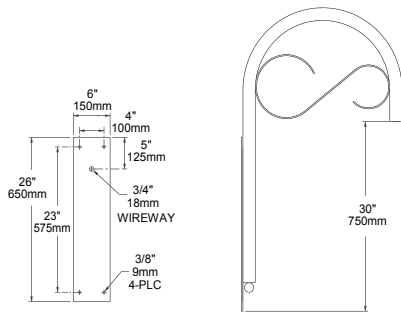

WMA39

WT: 14 LBS

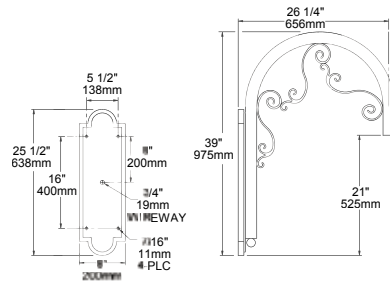

Job Name:

Messiah College - Fitness Center
 Architect: SPILLMAN FARMER - (BETHLEHEM)
 Contractor: FULLERTON ELECTRIC -
 (Elizabethtown)

Catalog Number:

111L-2-30LA-NW-UNIV-XX-PCB

Type:

Y

Notes:

PENN16-78192

Job:
 Type:
 Notes:

110 Line LED

111 Mini Sconce LED

Page 1 of 3

Philips Gardco 111 LED mini sconce luminaires are compact in size, perfect for low mounting height wall mount applications. 111 LED luminaires are designed to integrate naturally to wall surfaces. 111 LED luminaires are available with three (3) different distribution patterns, providing full cutoff performance (in the normal downlight position) and featuring LED arrays. Luminaires provide performance excellence and advanced Philips Gardco LED thermal management technology. High performance Class 1 LED systems offer potential energy savings of 50 % or more compared to HID systems. 111 LED luminaires are also available with 0-10V Dimming.

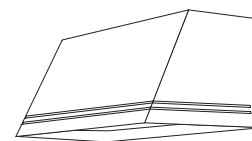

PREFIX	DISTRIBUTION	LED WATTAGE	LED SELECTION	VOLTAGE	FINISH	OPTIONS
<input type="text"/>	<input type="text"/>	<input type="text"/>	<input type="text"/>	<input type="text"/>	<input type="text"/>	<input type="text"/>

Enter the order code into the appropriate box above. Note: Philips Gardco reserves the right to refuse a configuration. Not all combinations and configurations are valid. Refer to notes below for exclusions and limitations. For questions or concerns, please consult the factory.

PREFIX

111L Trapezoidal Wedge LED - Constant Wattage / Full Light Output
111L-DIM Trapezoidal Wedge LED - 0 - 10V Dimming (Control system by others.)

DISTRIBUTION

2 Type II Wide Throw Optic, featuring Maximized Lateral Throw
3 Type III Preferred Wide Throw Optic, featuring Improved Forward Throw
4 Type IV Maximized Forward Throw Optic

See page 3 for more detailed luminaire configuration information.

LED WATTAGE AND LUMEN VALUES

Ordering Code	Average System Watts ¹	LED Current (mA)	LED Selection	Luminaire Initial Absolute Lumens ²			Basis of Lumen Data Photometric tests performed in compliance with IESNA LM-79.
				TYPE 2	TYPE 3	TYPE 4	
20LA	18	350	NW	1,683	1,791	1,701	
30LA	28	530	NW	2,432	2,613	2,467	
40LA	38	700	NW	3,122	3,354	3,118	

1. Wattage may vary by +/- 8% due to LED manufacturer forward volt specification and ambient temperature. Wattage shown is average for 120V through 277V input. Actual wattage may vary by an additional +/- 10% due to actual input voltage.
 2. Tests are in process for luminaires with the DL option. Contact Gardco.applications@philips.com if any approximate estimates are required for design purposes.

LED SELECTION

CW Cool White - 5700°K - 75 CRI
NW Neutral White - 4000°K - 70 CRI
WW Warm White - 3000°K - 70 CRI

VOLTAGE

UNIV 120V through 277V, 50hz or 60hz
 120
 208
 240
 277



Job Name:

Messiah College - Fitness Center
 Architect: SPILLMAN FARMER - (BETHLEHEM)
 Contractor: FULLERTON ELECTRIC -
 (Elizabethtown)

Catalog Number:

111L-2-30LA-NW-UNIV-XX-PCB

Type:

Y

Notes:

PENN16-78192

110 Line LED

111 Mini Sconce LED

Page 2 of 3

FINISH **Specify** **OPTIONS**

BRP	Bronze Paint	F³	Fusing
BLP	Black Paint	PCB³	Button Type Photocontrol
WP	White Paint	DL	Diffusing Lens (<i>reduces performance significantly</i>)
NP	Natural Aluminum Paint	WS⁴	Wall Mounted Box for Surface Conduit
BGP	Beige Paint		
OC	Optional Color Paint <i>Specify Optional Color or RAL ex: OC-LGP or OC-RAL7024.</i>		<i>3. Provide specific input voltage.</i>
SC	Special Paint <i>Specify. Must supply color chip.</i>		<i>4. Rear entry permitted.</i>

**Provide
Natural
Aluminum
Paint
finish**

DIMENSIONS

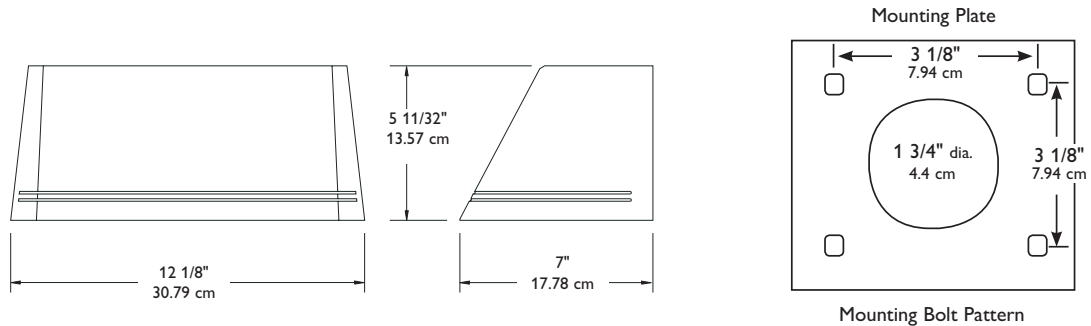

Note: Mounting plate center is located in the center of the luminaire width and 2.38" (6.03cm) above the luminaire bottom (lens down position). Splices must be made in the J-box (by others). Mounting plate must be secured by max. 5/16" (.79cm) diameter bolts (by others) structurally to the wall.

Job Name:

Messiah College - Fitness Center
 Architect: SPILLMAN FARMER - (BETHLEHEM)
 Contractor: FULLERTON ELECTRIC -
 (Elizabethtown)

Catalog Number:

111L-2-30LA-NW-UNIV-XX-PCB

Notes:

Type:

Y

PENN16-78192

110 Line LED

111 Mini Sconce LED

Page 3 of 3

LUMINAIRE CONFIGURATION INFORMATION

111L: Philips Gardco mini sconce LED providing constant wattage and constant light output when power to the luminaire is energized.

111L-DIM: Philips Gardco mini sconce LED provided with 0 -10V dimming for connection to a control system provided by others.

SPECIFICATIONS

GENERAL: Philips Gardco 111 LED Trapezoidal Wedge high performance sconce luminaires are Philips Gardco 111 LED mini sconce luminaires feature a compact size and are designed to integrate naturally to wall surfaces. 111 LED luminaires are available with three (3) different distribution patterns, providing full cutoff performance (in the normal downlight position) and featuring LED arrays. Luminaires provide performance excellence and advanced Philips Gardco LED thermal management technology. High performance Class 1 LED systems offer potential energy savings of 50 % or more compared to HID systems. 111 LED luminaires are also available with 0-10V Dimming. Surge protector standard. 10KA per AN SI/IEEE C62.41.2.

THERMAL MANAGEMENT: Philips Gardco 111 LED luminaires utilize extruded aluminum integral thermal radiation fins to provide the excellent thermal management so critical to long LED system life.

LED RELIABILITY:

PREDICTED LUMEN DEPRECIATION DATA		
Ambient Temperature °C	LED Wattage / Driver mA	L ₇₀ Hours ⁵
40 °C	20LA / 350 mA	225,000
	30LA / 530 mA	156,000
	40LA / 700 mA	110,000

5. Predicted performance derived from LED manufacturer's data and engineering design estimates, based on IESNA LM-80 methodology. Actual experience may vary due to field application conditions. L₇₀ is the predicted time when LED performance depreciates to 70% of initial lumen output.

OPTICAL SYSTEMS: Philips Gardco 111 LED luminaires utilize lensed LED arrays set to achieve IES Type II, Type III, and Type IV distributions. Individual LED arrays are replaceable. Luminaires feature high performance Class 1 LED systems.

HOUSING: Housings are die cast aluminum. A memory retentive gasket seals the housing to the door frame to exclude moisture, dust, insects and pollutants from the optical system. A black, die cast ribbed backplate dissipates heat for longer system life.

DOOR FRAME: A single-piece die cast aluminum door frame integrates to the housing form. The door frame is hinged closed and secured to the housing with captive stainless steel fasteners. The heat and impact resistant 1/8" (.32cm) tempered glass lens and one-piece gasket are mechanically secured to the door frame with galvanized steel retainers. A clear tempered glass lens is included. A diffuse lens is available as an option.

IP RATING: Luminaires are rated IP66.

FINISH: Each standard color luminaire receives a fade and abrasion resistant, electrostatically applied, thermally cured, triglycidic isocyanurate (TGIC) textured polyester powdercoat finish. Standard colors are as listed. Consult factory for specs on custom colors.

LABELS: All luminaires bear UL or CUL (where applicable) labels. Lens down application is Wet Location and lens up is Damp Location.

WARRANTY: Philips Gardco LED luminaires feature a 5 year limited warranty, including a 5 year limited warranty covering the LED arrays and LED drivers. See Warranty Information on www.sitelighting.com for complete details and exclusions.

FULL CUTOFF PERFORMANCE: Full cutoff performance means a luminaire distribution where zero candela intensity occurs at an angle at or above 90° above nadir. Additionally, the candela per 1000 lamp lumens does not numerically exceed 100 (10 percent) at a vertical angle of 80° above nadir. This applies to all lateral angles around the luminaire.



© 2014 Koninklijke Philips N.V. All rights reserved.

Philips reserves the right to make changes in specifications and/or to discontinue any product at any time without notice or obligation and will not be liable for any consequences resulting from the use of this publication.

G200-039 10/14 page 3 of 3 www.philips.com/luminaires

Philips Lighting
 North America Corporation
 200 Franklin Square Drive
 Somerset, NJ 08873
 Tel. 855-486-2216

Imported by: Philips Lighting,
 A division of Philips Electronics Ltd.
 281 Hillmount Rd,
 Markham, ON, Canada L6C 2S3
 Tel. 800-668-9008

Type: Z
 Job:
 Fixture Catalog number:
EL807/3L4KUV / DB
 Fixture Mode Finish

Approvals:

Date:
Page: 1 of 2

Specifications

Housing: Die-cast low copper alloy (<0.6% Cu) aluminum with clear anodized finish. Two 1/2" NPT in sides. Housing mounts into concrete, brick, or masonry (non-combustible materials). Internal splice area provided behind lamp plate.

Lens Frame: Die-cast aluminum, with silicone gasket, attaches to housing with two captive 10-32 stainless steel, hex socket cap screws.

Lens: Tempered prismatic glass with silicone gasket, concealed above lens frame opening.

Finish: On lens frame only, each luminaire receives a fade and abrasion resistant, electrostatically applied, thermally cured, triglycidal isocyanurate (TGIC) polyester powdercoat finish. Standard colors are Black (**BL**), Dark Bronze (**DB**), and Verde Green (**GR**).

Optical System: A total of 3 or 9 LED emitters are configured together as a module. Available in 3000K, 4200K, and 5100K.

Driver: Universal Voltage from 120 to 277V with a ±10% tolerance. -40° F. starting temperature. All drivers are Underwriters Laboratories recognized.

ORDERING INFORMATION

Fixture	Source
<input type="checkbox"/> EL807 / 3L3KUV ¹	5.3W, 3 LED's, 3000K
<input type="checkbox"/> EL807 / 3L4KUV ¹	5.3W, 3 LED's, 4200K
<input type="checkbox"/> EL807 / 3L5KUV ¹	5.3W, 3 LED's, 5100K

Fixture	Source
<input type="checkbox"/> EL807 / 9L3KUV ¹	10.5W, 9 LED's, 3000K
<input type="checkbox"/> EL807 / 9L4KUV ¹	10.5W, 9 LED's, 4200K
<input type="checkbox"/> EL807 / 9L5KUV ¹	10.5W, 9 LED's, 5100K

¹ Universal Voltage from 120 to 277V with a ±10% tolerance.
 For 5.3W, Max Amps. are .13 for 120V, .080 for 208V, .080 for 240V, .060 for 277V. For 10.8W, Max Amps. are .090 for 120V, .050 for 208V, .040 for 240V, .040 for 277V..

Finish

- BL - Black
- DB - Dark Bronze
- GR - Verde Green

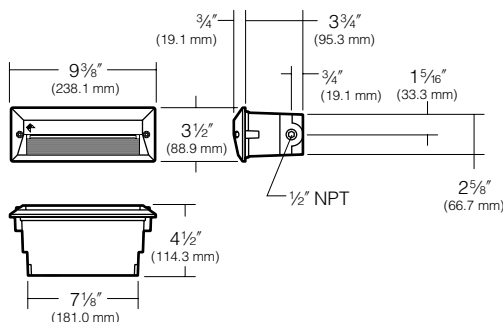

Listings and Ratings

UL cUL 1598 ¹	IP66 Rated	25C Ambient
--------------------------	------------	-------------

¹Suitable for wet locations

KIM LIGHTING RESERVES THE RIGHT TO CHANGE SPECIFICATIONS WITHOUT NOTICE.

Type:

Job:

Page: 2 of 2

Lumen Data

Spectroradiometric			
	3000K	4200K	5100K
Correlated Color Temp. CCT (K)	2800 to 3175K	3800 to 4600K	4600 to 5600K
Color Rendering Index (CRI)	≥75	≥70	≥65

ELECTRICAL - Drive Current @350mA (3 LEDs)		
Volts -AC	Amps - AC	System Watts
120	0.13	5.3
208	0.08	5.3
240	0.08	5.3
277	0.06	5.3

ELECTRICAL - Drive Current @350mA (9 LEDs)		
Volts -AC	Amps - AC	System Watts
120	0.09	10.5
208	0.05	10.5
240	0.04	10.5
277	0.04	10.5

Absolute Lumens (3 LEDs)	
Temperature	EL807/3L*K
3000K	61
4200K	71
5100K	78

Absolute Lumens (9 LEDs)	
Temperature	EL807/9L*K
3000K	167
4200K	188
5100K	211

Lumens Per Watt (3 LEDs)	
Temperature	EL807/3L*K
3000K	11.5
4200K	13.4
5100K	14.7





Lumens Per Watt (9 LEDs)	
Temperature	EL807/9L*K
3000K	15.9
4200K	17.9
5100K	20.1

FEATURES



- DLC qualified
- Up to 1000' wireless communication
- Motion sensing up to 40' mounting height
- Superior BUG ratings
- Types II, III, IV, V and custom distributions
- IP66, 3G vibration housing
- 20kV/10kA surge suppression
- 2700 – 5000K CCT
- >560 nm Amber
- Custom lumen packages
- Integral thermal protection
- 0-10V dimmable
- 13 standard powder coat finishes

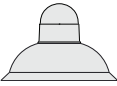
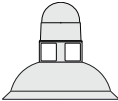
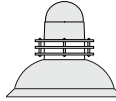
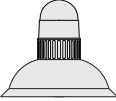
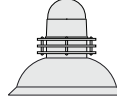

SPECIFICATIONS

					
ANGLED HOOD CONFIGURATION	UCM-ANG	UCM-WND-ANG	UCM-SR-ANG	UCM-VSL-ANG	UCM-LUM-ANG
DIAMETER	20"/508mm	20"/508mm	20"/508mm	20"/508mm	20"/508mm
HEIGHT	14.7"/373mm	20.5"/520mm	20.7"/526mm	20.5"/521mm	20.6"/523mm
WEIGHT	18.25 lbs/8.28kg	21.75 lbs/9.86kg	25 lbs/11.3kg	22.25 lbs/10.1kg	24.25 lbs/11kg
EPA	.60	.72	.74	.72	.74

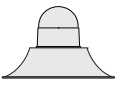
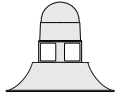
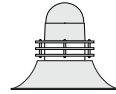
					
BELL HOOD CONFIGURATION	UCM-BEL	UCM-WND-BEL	UCM-SR-BEL	UCM-VSL-BEL	UCM-LUM-BEL
DIAMETER	24"/610mm	24"/610mm	24"/610mm	24"/610mm	24"/610mm
HEIGHT	15.8"/401mm	21.4"/543mm	21.6"/549mm	19.37"/492mm	21.5"/546mm
WEIGHT	20.25 lbs/9.2kg	23.5 lbs/10.6kg	27 lbs/12.25kg	24.25 lbs/11kg	26 lbs/11.8kg
EPA	.73	.85	.87	.85	.85

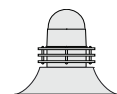
					
FLARE HOOD CONFIGURATION	UCM-FLR	UCM-WND-FLR	UCM-SR-FLR	UCM-VSL-FLR	UCM-LUM-FLR
DIAMETER	22"/559mm	22"/559mm	22"/559mm	22"/559mm	22"/559mm
HEIGHT	14.5"/368mm	19.8"/503mm	20.1"/510mm	19.8"/503mm	20"/508mm
WEIGHT	18.5 lbs/8.4kg	21.75 lbs/9.87kg	25.25 lbs/10.1kg	21.75 lbs/9.86kg	24.25 lbs/11kg
EPA	.53	.65	.67	.65	.67

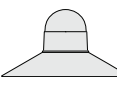
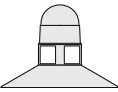
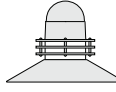
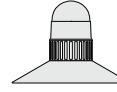
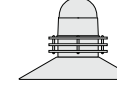
					
STRAIGHT HOOD CONFIGURATION	UCM-STR	UCM-WND-STR	UCM-SR-STR	UCM-VSL-STR	UCM-LUM-STR
DIAMETER	24"/610mm	24"/610mm	24"/610mm	24"/610mm	24"/610mm
HEIGHT	14"/355mm	19.8"/503mm	20"/508mm	19.8"/503mm	19.9"/505mm
WEIGHT	20 lbs/9.07kg	23.25 lbs/10.55kg	26.75 lbs/12.13kg	23.75 lbs/10.77kg	25.75 lbs/11.68kg
EPA	.59	.71	.73	.71	.73

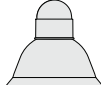
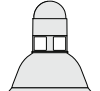
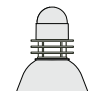
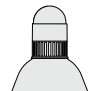
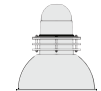
					
SKIRTED BELL HOOD CONFIGURATION	UCM-SKB	UCM-WND-SKB	UCM-SR-SKB	UCM-VSL-SKB	UCM-LUM-SKB
DIAMETER	24"/610mm	24"/610mm	24"/610mm	24"/610mm	24"/610mm
HEIGHT	19.7"/500mm	23.9"/607mm	24.2"/615mm	23.9"/607mm	24.1"/612mm
WEIGHT	20.5 lbs/9.3kg	23.75 lbs/10.77kg	27 lbs/12.25kg	24.25 lbs/11kg	26.25 lbs/11.9kg
EPA	.90	1.03	1.05	1.03	1.05



ARCHITECTURAL AREA LIGHTING
 16555 East Gale Ave. | City of Industry | CA 91745
 P 626.968.5666 | F 626.369.2695 | www.aal.net
 Copyright © 2014 Rev 9.15



JOB	_____
TYPE	_____
NOTES	_____

ORDERING INFORMATION

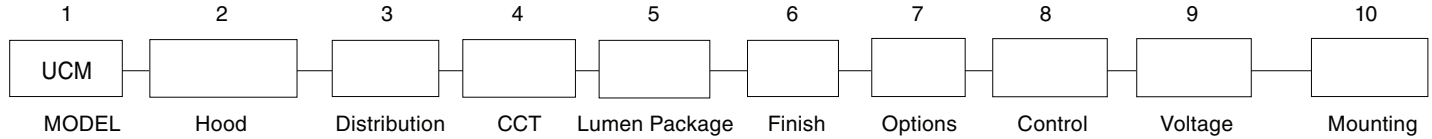

1. MODEL (Must choose one)

- UCM *Universe medium without luminous element*
- UCM-WND *Universe medium with luminous window*
- UCM-SR *Universe medium with luminous solid rings*
- UCM-VSL *Universe medium with luminous vertical slots*
- UCM-LUM *Universe medium with luminous rings*

2. HOOD

- FLR *Flared hood*
- FLR-STSS *Flared hood in natural brushed stainless steel*
- FLR-COP *Flared hood in natural brushed copper*
- ANG *Angled hood*
- ANG-STSS *Angled hood in natural brushed stainless steel*
- ANG-COP *Angled hood in natural brushed copper*
- STR *Straight hood*
- STR-STSS *Straight hood in natural brushed stainless steel*
- STR-COP *Straight hood in natural brushed copper*
- BEL *Bell hood*
- BEL-STSS *Bell hood in natural brushed stainless steel*
- BEL-COP *Bell hood in natural brushed copper*
- SKB *Skirted bell hood*
- SKB-STSS *Skirted bell hood in natural brushed stainless steel*
- SKB-COP *Skirted bell hood in natural brushed copper*

3. DISTRIBUTION (Must choose one)

- MicroCore Precision aimed optics
- T2-32LED *Type 2*
- T3-32LED *Type 3*
- T4-32LED *Type 4*
- T5-32LED *Type 5*
- TX-32LED *Custom¹*

4. COLOR TEMPERATURE (Must choose one)

- 3K *3000K*
- 4K *4000K*
- 5K *5000K*
- 27K *2700K¹*
- 35K *3500K¹*
- AM *>560 nm monochromatic amber¹*

5. LUMEN PACKAGE (Must choose one)

- 700 *71 watts*
- 450 *48 watts*
- XMA *Custom wattage or drive current¹*

6. FINISH (Must choose one)

- WH *Arctic White*
- BL *Black*
- BLT *Matte Black*
- DGN *Dark Green*
- DB *Dark Bronze*
- WDB *Weathered Bronze*
- MDB *Bronze Metallic*
- VBV *Verde Blue*
- CRT *Corten*
- MAL *Matte Aluminum*
- MG *Medium Grey*
- AGN *Antique Green*
- LG *Light Grey*
- RAL *Premium Color*
- CUSTOM ** *Contact Factory*

7. OPTIONS (May choose as noted)

- FTG *Flat clear glass lens²*
- FLD *Flat diffused glass lens³*
- SAG *Sag clear glass lens^{1,3}*
- HSS *House Side shield for Type 4*
- SLC *Unlit (luminous) element*
- R80 *80 CRI minimum²*
- BL *Blue inner lens*
- RD *Red inner lens*
- GRN *Green inner lens*

8. CONTROLS – (May choose as noted)

- WIR *wiScape connectivity*
- WIRSC *wiScape connectivity, integral motion sensor*
- SCP *Integral photo-control and motion sensor⁴*
- SCPREMOTE *Handheld commissioning tool⁴*

9. VOLTAGE (May choose as noted)

- 120-277 *120-277 VAC input*
- 347 *347 VAC input*
- 480 *480 VAC input*

9. MOUNTING – Must choose one

- POLE MOUNT**
- SLA2 *SLA3*
 - SLA4 *SLA4-2*
 - SLA7 *SLA7-2*
 - SLA7(5) *SLA7(5)-2*
 - SLA8D *SLA9*
 - SLA9-2 *SLA10*
 - SLA10-2 *SLA16*
 - SLA16-2 *SLA17*
 - SLA17-2 *SLA17(5)*
 - SLA17(5)-2 *SLA18*
 - SLA18-2 *SLA20*
 - SLA20-2 *SLA20A*
 - SLA20A-2 *SLA20B*
 - SLA20B-2 *SLA20C*
 - SLA20C-2 *SLA20D*
 - SLA20D-2 *SLA22D*
 - SLA24 *SLA24-2*
 - SLA24(5) *SLA24(5)-2*
 - TRA4 *TRA7*
 - TRA7-2 *TRA8*
 - TRA8-2 *TRA9*
 - TRA9-2

WALL MOUNT

- WMA4 *WMA5*
- WMA6 *WMA8*
- WMA9D *WMA10*
- WMA11 *WMA12*
- WMA16 *WMA17*
- WMA18 *WMA20*
- WMA22D *WMA24*
- WMA37 *WMA38*
- WMA39

¹ Contact factory

² Note for AM color temperature

³ Not for WIR, WIRSC or SCP control options

⁴ Handheld commissioning tool is required to separately configure or adjust any number of SCP sensors.



JOB	_____
TYPE	_____
NOTES	_____

LUMINAIRE PERFORMANCE

Optical System	Secondary Lens or Shield	Distribution	Light Engine	Ordering Code												Drive Current (ma)	System Watts			
				3K			4K			5K										
				Delivered Lumens	Efficacy (lm/w)	Bug Rating	Delivered Lumens	Efficacy (lm/w)	Bug Rating	Delivered Lumens	Efficacy (lm/w)	Bug Rating								
MicroCore	No Lens (Standard)	TYPE 2	T2-32LED	6186	87	2	0	2	6561	92	2	0	2	6579	92	2	0	2	650	71
		TYPE 3	T3-32LED	6168	87	1	0	2	6542	92	1	0	2	6560	92	1	0	2		
		TYPE 4	T4-32LED	6081	86	1	0	2	6449	91	1	0	2	6467	91	1	0	2		
		TYPE 5	T5-32LED	6227	88	3	0	2	6505	93	3	0	2	6623	93	3	0	2		
	House Side Shield	TYPE 4	T4-32LED-...-HSS	4495	63	0	0	2	4768	67	0	0	2	4781	67	0	0	2	450	47
	No Lens (Standard)	TYPE 2	T2-32LED	4607	98	2	0	2	4830	103	2	0	2	4844	101	2	0	2		
		TYPE 3	T3-32LED	4570	95	1	0	1	4791	100	1	0	2	4805	101	1	0	2		
		TYPE 4	T4-32LED	4570	97	1	0	2	4791	102	1	0	2	4805	100	1	0	2		
	TYPE 5	T5-32LED	4602	98	3	0	1	4825	103	3	0	1	4839	101	3	0	1			
	House Side Shield	TYPE 4	T4-32LED-...-HSS	3366	72	0	0	2	3529	75	0	0	2	3539	74	0	0	2		

* DesignLights Consortium® Qualified Product



ELECTRICAL CHARACTERISTICS

Optical System	Ordering Code		Driver										Dimming						
			LED Drive mA	System Watts	Line Voltage		Amps AC				Min. Power Factor	Max THD (%)	Operating Temp. Range	Dimming Range	Source current out of 0-10V purple wire		Absolute voltage range on 0-10V (+) purple wire		
					VAC	HZ	120	277	347	480					Min	Max	Min	Max	
MicroCore	Without Luminous Element	32LED	700	650	71	120	50/60	0.6	0.3	0.2	0.1	≥9	20	-30°C TO +40°C	10% TO 100%	0mA	1mA	0mA	1mA
			450	450	47			0.4	0.2	0.1	0.1								
	700		650	73	0.6			0.3	0.2	0.2									
	450		450	49	0.4			0.2	0.1	0.1									
	WND/SR/VSL/LUM																		

SENSOR DETECTION RANGE

		SENSOR MOUNTING HEIGHT											RATIO
		8'	10'	12'	14'	16'	18'	20'	25'	30'	35'	40'	
COVERAGE	SCP	20'	25'	30'	35'	40'	45'	50'	62.5'	75'	87.5'	100'	1:2.5
DIAMETER	WIRSC	16'	20'	24'	28'	32'	36'	40'	N/A	N/A	N/A	N/A	1:2

LED COLOR

	Ordering Code		
	3K	4K	5K
CCT Average	3000K	4000K	5000K
CRI Minimum	70	70	70
S/P Ratio	1.2	1.5	1.8

Consult factory for Amber, Turtle Friendly, Gulf Coast and Observatory applications.

TM-21 LIFETIME CALCULATION

Optical System	Ordering Code	Ambient Environment °C	Projected Lumen Maintenance (% vs. Khrs)					Reported L70
			15	25	50	60	100	
MicroCore	32LED	15	98	98	97	96	94	>96Khrs
		25	98	97	96	96	93	
		40	96	95	93	92	89	



ARCHITECTURAL AREA LIGHTING
 16555 East Gale Ave. | City of Industry | CA 91745
 P 626.968.5666 | F 626.369.2695 | www.aal.net
 Copyright © 2014 Rev 9.15

JOB	_____
TYPE	_____
NOTES	_____

SPECIFICATIONS

HOUSING

- All housing components shall be die-cast aluminum, sealed with continuous silicone rubber gaskets.
- Hood and spacers shall be heavy gauge spun aluminum with hemmed edges for added rigidity.
- Luminous rings shall be clear acrylic with an internal lens.
- Standard configurations do not require a flat lens, optional lenses shall be tempered glass
- All internal and external hardware shall be stainless steel.
- Optical bezel finish shall match the luminaire housing.

OPTICAL

- Patent pending MicroCore™ LED modules shall independently aim each light emitting diode (LED) in both horizontal rotation and vertical tilt angle.
- LEDs shall be mounted to a metal printed circuit board assembly (PCBA) with a uniform conformal coating over the panel surface and electrical features.
- LED optics shall be clear injection molded PMMA acrylic.
- MicroCore™ PCBA and optic shall be sealed to a die-cast anodized aluminum heat sink with an injection molded silicone rubber gasket. IP66.
- Type 4 distribution with optional House Side Shield not available with clear or diffused glass lenses. Factory installed House Side Shield is optimized for Type 4 distribution and not recommended for use with Type 2 or 3 distribution and not available with type 5 distribution.

ELECTRICAL

- Luminaires shall have integral surge protection that shall be U.L. recognized and have a surge current rating of 10,000 Amps using the industry standard 8/20uSec wave and surge rating of 372J.
- Drivers shall be U.L. recognized with an inrush current maximum of <20.0 Amps maximum at 230VAC.
- Drivers shall not be compatible with current sourcing dimmers, consult factory for current list of known compatible dimming systems, approved dimmers include Lutron Diva AVTV, Lutron Nova NFTV and NTFTV.

CONTROLS

- Wireless enabled fixtures shall support bi-directional radio frequency (RF) communications utilizing IEEE 802.15.4 operating in the 2.4GHZ ISM band.
- Up to 1000' wireless range may be reduced by physical obstructions between fixtures.
- Motion sensor shall be flame retardant, UV resistant, impact resistant, recyclable polycarbonate.
- Motion Sensor shall use passive infrared (PIR) sensing technology that reacts to changes in infrared energy (moving body heat) within the coverage area. Careful consideration must be given to obstructions that may block the sensor's line of sight.
- Factory default settings for SCP option shall be:
 - High mode: 10V
 - Low mode: 1V
 - Ramp-up rate: disabled
 - Fade-down rate: disabled
 - Photocell: Off
 - Sensitivity: Full
 - Time Delay: Fade to low: 5 minutes
 - Time Delay: Fade to off: 1 hour

PHOTOCELL / EGRESS ADAPTERS

- Adapter(s) shall slip over a 4"/100mm DIA. pole with the luminaire or arm slipping over the adapter to add a total of 4.5"/114mm to the overall height. Adapter(s) shall be prewired, independently rotatable 359°, and have a cast access cover with an integral lens and lanyard.
- Photocell adapter shall include an internal twist lock receptacle. Photocell by others.
- Egress adapter shall require an auxiliary 120 volt supply for operation of an integral MR16 lamp in the event of emergency. The lamp may be aimed and locked into position with an adjustment range of 15°-45°. Adapter shall have a socket that accepts miniature bi-pin MR16 lamps up to 50 watts, lamp by others.

SERVICING

- Luminaire shall have tool-less service access to the gear compartment. Driver and surge suppressor shall be mounted to a prewired tray with quick disconnects that may be removed from the gear compartment.

ARM MOUNTING

- Luminaire shall be attached to the arm assembly with three stainless steel bolts. The connection shall be sealed with a silicone compression gasket.
- Post top arms and brackets shall slip over a 4"/100mm O.D. or a 5"/127mm as configured and secured with six stainless steel set screws.
- Wall mounted arms and brackets shall require mounting hardware by others.

FINISH

- Luminaire finish shall consist of a five stage pretreatment regimen with a polymer primer sealer, oven dry off, and top coated with a thermoset super TGIC polyester powder coat finish.
- Luminaire finish shall meet the AAMA 605.2 performance specification which includes passing a 3000 hour salt spray test for corrosion resistance.

CERTIFICATION

- Luminaire shall be listed with ETL for outdoor, wet location use, UL1598, UL 8750 and Canadian CSA Std. C22.2 no.250.

WARRANTY / TERMS AND CONDITIONS OF SALE

Download: <http://www.hubbellighting.com/resources/warranty/>







JOB	_____
TYPE	_____
NOTES	_____

FEATURES

- DLC qualified
- Up to 1000' wireless communication
- Motion sensing up to 40' mounting height
- Superior BUG ratings
- Types II, III, IV, V and custom distributions
- IP66, 3G vibration housing
- 20kV/10kA surge suppression
- 2700 – 5000K CCT
- >560 nm Amber
- Custom lumen packages
- Integral thermal protection
- 0-10V dimmable
- 13 standard powder coat finishes



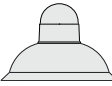
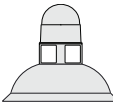
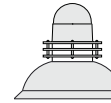
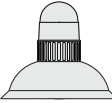
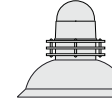

SPECIFICATIONS

					
ANGLED HOOD CONFIGURATION	UCM-ANG	UCM-WND-ANG	UCM-SR-ANG	UCM-VSL-ANG	UCM-LUM-ANG
DIAMETER	20"/508mm	20"/508mm	20"/508mm	20"/508mm	20"/508mm
HEIGHT	14.7"/373mm	20.5"/520mm	20.7"/526mm	20.5"/521mm	20.6"/523mm
WEIGHT	18.25 lbs/8.28kg	21.75 lbs/9.86kg	25 lbs/11.3kg	22.25 lbs/10.1kg	24.25 lbs/11kg
EPA	.60	.72	.74	.72	.74

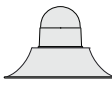
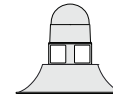
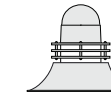
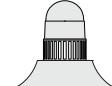
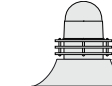
					
BELL HOOD CONFIGURATION	UCM-BEL	UCM-WND-BEL	UCM-SR-BEL	UCM-VSL-BEL	UCM-LUM-BEL
DIAMETER	24"/610mm	24"/610mm	24"/610mm	24"/610mm	24"/610mm
HEIGHT	15.8"/401mm	21.4"/543mm	21.6"/549mm	19.37"/492mm	21.5"/546mm
WEIGHT	20.25 lbs/9.2kg	23.5 lbs/10.6kg	27 lbs/12.25kg	24.25 lbs/11kg	26 lbs/11.8kg
EPA	.73	.85	.87	.85	.85

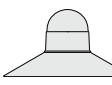
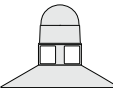
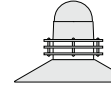
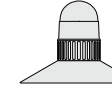
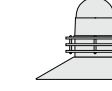
					
FLARE HOOD CONFIGURATION	UCM-FLR	UCM-WND-FLR	UCM-SR-FLR	UCM-VSL-FLR	UCM-LUM-FLR
DIAMETER	22"/559mm	22"/559mm	22"/559mm	22"/559mm	22"/559mm
HEIGHT	14.5"/368mm	19.8"/503mm	20.1"/510mm	19.8"/503mm	20"/508mm
WEIGHT	18.5 lbs/8.4kg	21.75 lbs/9.87kg	25.25 lbs/10.1kg	21.75 lbs/9.86kg	24.25 lbs/11kg
EPA	.53	.65	.67	.65	.67

					
STRAIGHT HOOD CONFIGURATION	UCM-STR	UCM-WND-STR	UCM-SR-STR	UCM-VSL-STR	UCM-LUM-STR
DIAMETER	24"/610mm	24"/610mm	24"/610mm	24"/610mm	24"/610mm
HEIGHT	14"/355mm	19.8"/503mm	20"/508mm	19.8"/503mm	19.9"/505mm
WEIGHT	20 lbs/9.07kg	23.25 lbs/10.55kg	26.75 lbs/12.13kg	23.75 lbs/10.77kg	25.75 lbs/11.68kg
EPA	.59	.71	.73	.71	.73

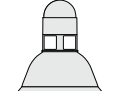
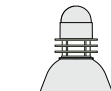
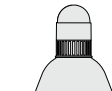
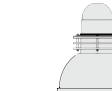
					
SKIRTED BELL HOOD CONFIGURATION	UCM-SKB	UCM-WND-SKB	UCM-SR-SKB	UCM-VSL-SKB	UCM-LUM-SKB
DIAMETER	24"/610mm	24"/610mm	24"/610mm	24"/610mm	24"/610mm
HEIGHT	19.7"/500mm	23.9"/607mm	24.2"/615mm	23.9"/607mm	24.1"/612mm
WEIGHT	20.5 lbs/9.3kg	23.75 lbs/10.77kg	27 lbs/12.25kg	24.25 lbs/11kg	26.25 lbs/11.9kg
EPA	.90	1.03	1.05	1.03	1.05



ARCHITECTURAL AREA LIGHTING
 16555 East Gale Ave. | City of Industry | CA 91745
 P 626.968.5666 | F 626.369.2695 | www.aal.net
 Copyright © 2014 Rev 9.15



JOB	_____
TYPE	_____
NOTES	_____

ORDERING INFORMATION

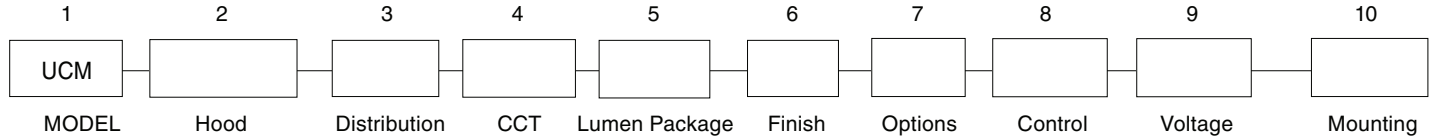

1. MODEL (Must choose one)

- UCM *Universe medium without luminous element*
- UCM-WND *Universe medium with luminous window*
- UCM-SR *Universe medium with luminous solid rings*
- UCM-VSL *Universe medium with luminous vertical slots*
- UCM-LUM *Universe medium with luminous rings*

2. HOOD

- FLR *Flared hood*
- FLR-STSS *Flared hood in natural brushed stainless steel*
- FLR-COP *Flared hood in natural brushed copper*
- ANG *Angled hood*
- ANG-STSS *Angled hood in natural brushed stainless steel*
- ANG-COP *Angled hood in natural brushed copper*
- STR *Straight hood*
- STR-STSS *Straight hood in natural brushed stainless steel*
- STR-COP *Straight hood in natural brushed copper*
- BEL *Bell hood*
- BEL-STSS *Bell hood in natural brushed stainless steel*
- BEL-COP *Bell hood in natural brushed copper*
- SKB *Skirted bell hood*
- SKB-STSS *Skirted bell hood in natural brushed stainless steel*
- SKB-COP *Skirted bell hood in natural brushed copper*

3. DISTRIBUTION (Must choose one)

- MicroCore Precision aimed optics
- T2-32LED *Type 2*
- T3-32LED *Type 3*
- T4-32LED *Type 4*
- T5-32LED *Type 5*
- TX-32LED *Custom¹*

4. COLOR TEMPERATURE (Must choose one)

- 3K *3000K*
- 4K *4000K*
- 5K *5000K*
- 27K *2700K¹*
- 35K *3500K¹*
- AM *>560 nm monochromatic amber¹*

5. LUMEN PACKAGE (Must choose one)

- 700 *71 watts*
- 450 *48 watts*
- XMA *Custom wattage or drive current¹*

6. FINISH (Must choose one)

- WH *Arctic White*
- BL *Black*
- BLT *Matte Black*
- DGN *Dark Green*
- DB *Dark Bronze*
- WDB *Weathered Bronze*
- MDB *Bronze Metallic*
- VBV *Verde Blue*
- CRT *Corten*
- MAL *Matte Aluminum*
- MG *Medium Grey*
- AGN *Antique Green*
- LG *Light Grey*
- RAL *Premium Color*
- CUSTOM ** *Contact Factory*

7. OPTIONS (May choose as noted)

- FTG *Flat clear glass lens²*
- FLD *Flat diffused glass lens³*
- SAG *Sag clear glass lens^{1,3}*
- HSS *House Side shield for Type 4*
- SLC *Unlit (luminous) element*
- R80 *80 CRI minimum²*
- BL *Blue inner lens*
- RD *Red inner lens*
- GRN *Green inner lens*

8. CONTROLS – (May choose as noted)

- WIR *wiScape connectivity*
- WIRSC *wiScape connectivity, integral motion sensor*
- SCP *Integral photo-control and motion sensor⁴*
- SCPREMOTE *Handheld commissioning tool⁴*

9. VOLTAGE (May choose as noted)

- 120-277 *120-277 VAC input*
- 347 *347 VAC input*
- 480 *480 VAC input*

9. MOUNTING – Must choose one

- POLE MOUNT**
- SLA2 *SLA3*
 - SLA4 *SLA4-2*
 - SLA7 *SLA7-2*
 - SLA7(5) *SLA7(5)-2*
 - SLA8D *SLA9*
 - SLA9-2 *SLA10*
 - SLA10-2 *SLA16*
 - SLA16-2 *SLA17*
 - SLA17-2 *SLA17(5)*
 - SLA17(5)-2 *SLA18*
 - SLA18-2 *SLA20*
 - SLA20-2 *SLA20A*
 - SLA20A-2 *SLA20B*
 - SLA20B-2 *SLA20C*
 - SLA20C-2 *SLA20D*
 - SLA20D-2 *SLA22D*
 - SLA24 *SLA24-2*
 - SLA24(5) *SLA24(5)-2*
 - TRA4 *TRA7*
 - TRA7-2 *TRA8*
 - TRA8-2 *TRA9*
 - TRA9-2

WALL MOUNT

- WMA4 *WMA5*
- WMA6 *WMA8*
- WMA9D *WMA10*
- WMA11 *WMA12*
- WMA16 *WMA17*
- WMA18 *WMA20*
- WMA22D *WMA24*
- WMA37 *WMA38*
- WMA39

¹ Contact factory

² Note for AM color temperature

³ Not for WIR, WIRSC or SCP control options

⁴ Handheld commissioning tool is required to separately configure or adjust any number of SCP sensors.

LUMINAIRE PERFORMANCE

Optical System	Secondary Lens or Shield	Distribution	Light Engine	Ordering Code												Drive Current (ma)	System Watts			
				3K			4K			5K										
				Delivered Lumens	Efficacy (lm/w)	Bug Rating	Delivered Lumens	Efficacy (lm/w)	Bug Rating	Delivered Lumens	Efficacy (lm/w)	Bug Rating								
MicroCore	No Lens (Standard)	TYPE 2	T2-32LED	6186	87	2	0	2	6561	92	2	0	2	6579	92	2	0	2	650	71
		TYPE 3	T3-32LED	6168	87	1	0	2	6542	92	1	0	2	6560	92	1	0	2		
		TYPE 4	T4-32LED	6081	86	1	0	2	6449	91	1	0	2	6467	91	1	0	2		
		TYPE 5	T5-32LED	6227	88	3	0	2	6505	93	3	0	2	6623	93	3	0	2		
	House Side Shield	TYPE 4	T4-32LED-...-HSS	4495	63	0	0	2	4768	67	0	0	2	4781	67	0	0	2	450	47
	No Lens (Standard)	TYPE 2	T2-32LED	4607	98	2	0	2	4830	103	2	0	2	4844	101	2	0	2		
		TYPE 3	T3-32LED	4570	95	1	0	1	4791	100	1	0	2	4805	101	1	0	2		
		TYPE 4	T4-32LED	4570	97	1	0	2	4791	102	1	0	2	4805	100	1	0	2		
	TYPE 5	T5-32LED	4602	98	3	0	1	4825	103	3	0	1	4839	101	3	0	1			
	House Side Shield	TYPE 4	T4-32LED-...-HSS	3366	72	0	0	2	3529	75	0	0	2	3539	74	0	0	2		

* DesignLights Consortium® Qualified Product



ELECTRICAL CHARACTERISTICS

Optical System	Ordering Code		Driver										Dimming										
			LED Drive mA	System Watts	Line Voltage		Amps AC				Min. Power Factor	Max THD (%)	Operating Temp. Range	Dimming Range	Source current out of 0-10V purple wire		Absolute voltage range on 0-10V (+) purple wire						
					VAC	HZ	120	277	347	480					Min	Max	Min	Max					
MicroCore	Without Luminous Element	32LED	700	650	71	120	50/60	0.6	0.3	0.2	0.1	≥9	20	-30°C TO +40°C	10% TO 100%	0mA	1mA	0mA	1mA				
			450	450	47															277	0.4	0.2	0.1
	700		650	73	347															0.6	0.3	0.2	0.2
	450		450	49	480															0.4	0.2	0.1	0.1
	WND/SR/VSL/LUM																						

SENSOR DETECTION RANGE

		SENSOR MOUNTING HEIGHT											RATIO
		8'	10'	12'	14'	16'	18'	20'	25'	30'	35'	40'	
COVERAGE	SCP	20'	25'	30'	35'	40'	45'	50'	62.5'	75'	87.5'	100'	1:2.5
DIAMETER	WIRSC	16'	20'	24'	28'	32'	36'	40'	N/A	N/A	N/A	N/A	1:2

LED COLOR

	Ordering Code		
	3K	4K	5K
CCT Average	3000K	4000K	5000K
CRI Minimum	70	70	70
S/P Ratio	1.2	1.5	1.8

Consult factory for Amber, Turtle Friendly, Gulf Coast and Observatory applications.

TM-21 LIFETIME CALCULATION

Optical System	Ordering Code	Ambient Environment °C	Projected Lumen Maintenance (% vs. Khrs)					Reported L70
			15	25	50	60	100	
MicroCore	32LED	15	98	98	97	96	94	>96Khrs
		25	98	97	96	96	93	
		40	96	95	93	92	89	



ARCHITECTURAL AREA LIGHTING
 16555 East Gale Ave. | City of Industry | CA 91745
 P 626.968.5666 | F 626.369.2695 | www.aal.net
 Copyright © 2014 Rev 9.15

JOB _____
 TYPE _____
 NOTES _____

SPECIFICATIONS

HOUSING

- All housing components shall be die-cast aluminum, sealed with continuous silicone rubber gaskets.
- Hood and spacers shall be heavy gauge spun aluminum with hemmed edges for added rigidity.
- Luminous rings shall be clear acrylic with an internal lens.
- Standard configurations do not require a flat lens, optional lenses shall be tempered glass
- All internal and external hardware shall be stainless steel.
- Optical bezel finish shall match the luminaire housing.

OPTICAL

- Patent pending MicroCore™ LED modules shall independently aim each light emitting diode (LED) in both horizontal rotation and vertical tilt angle.
- LEDs shall be mounted to a metal printed circuit board assembly (PCBA) with a uniform conformal coating over the panel surface and electrical features.
- LED optics shall be clear injection molded PMMA acrylic.
- MicroCore™ PCBA and optic shall be sealed to a die-cast anodized aluminum heat sink with an injection molded silicone rubber gasket. IP66.
- Type 4 distribution with optional House Side Shield not available with clear or diffused glass lenses. Factory installed House Side Shield is optimized for Type 4 distribution and not recommended for use with Type 2 or 3 distribution and not available with type 5 distribution.

ELECTRICAL

- Luminaires shall have integral surge protection that shall be U.L. recognized and have a surge current rating of 10,000 Amps using the industry standard 8/20uSec wave and surge rating of 372J.
- Drivers shall be U.L. recognized with an inrush current maximum of <20.0 Amps maximum at 230VAC.
- Drivers shall not be compatible with current sourcing dimmers, consult factory for current list of known compatible dimming systems, approved dimmers include Lutron Diva AVTV, Lutron Nova NFTV and NTFTV.

CONTROLS

- Wireless enabled fixtures shall support bi-directional radio frequency (RF) communications utilizing IEEE 802.15.4 operating in the 2.4GHZ ISM band.
- Up to 1000' wireless range may be reduced by physical obstructions between fixtures.
- Motion sensor shall be flame retardant, UV resistant, impact resistant, recyclable polycarbonate.
- Motion Sensor shall use passive infrared (PIR) sensing technology that reacts to changes in infrared energy (moving body heat) within the coverage area. Careful consideration must be given to obstructions that may block the sensor's line of sight.
- Factory default settings for SCP option shall be:
 - High mode: 10V
 - Low mode: 1V
 - Ramp-up rate: disabled
 - Fade-down rate: disabled
 - Photocell: Off
 - Sensitivity: Full
 - Time Delay: Fade to low: 5 minutes
 - Time Delay: Fade to off: 1 hour

PHOTOCELL / EGRESS ADAPTERS

- Adapter(s) shall slip over a 4"/100mm DIA. pole with the luminaire or arm slipping over the adapter to add a total of 4.5"/114mm to the overall height. Adapter(s) shall be prewired, independently rotatable 359°, and have a cast access cover with an integral lens and lanyard.
- Photocell adapter shall include an internal twist lock receptacle. Photocell by others.
- Egress adapter shall require an auxiliary 120 volt supply for operation of an integral MR16 lamp in the event of emergency. The lamp may be aimed and locked into position with an adjustment range of 15°-45°. Adapter shall have a socket that accepts miniature bi-pin MR16 lamps up to 50 watts, lamp by others.

SERVICING

- Luminaire shall have tool-less service access to the gear compartment. Driver and surge suppressor shall be mounted to a prewired tray with quick disconnects that may be removed from the gear compartment.

ARM MOUNTING

- Luminaire shall be attached to the arm assembly with three stainless steel bolts. The connection shall be sealed with a silicone compression gasket.
- Post top arms and brackets shall slip over a 4"/100mm O.D. or a 5"/127mm as configured and secured with six stainless steel set screws.
- Wall mounted arms and brackets shall require mounting hardware by others.

FINISH

- Luminaire finish shall consist of a five stage pretreatment regimen with a polymer primer sealer, oven dry off, and top coated with a thermoset super TGIC polyester powder coat finish.
- Luminaire finish shall meet the AAMA 605.2 performance specification which includes passing a 3000 hour salt spray test for corrosion resistance.

CERTIFICATION

- Luminaire shall be listed with ETL for outdoor, wet location use, UL1598, UL 8750 and Canadian CSA Std. C22.2 no.250.

WARRANTY / TERMS AND CONDITIONS OF SALE

Download: <http://www.hubbellighting.com/resources/warranty/>



JOB	_____
TYPE	_____
NOTES	_____

DB12 – Decorative Pole

TYPE

S1, S1A

4" ROUND (RD) & FLUTED (FL) DECORATIVE BASE



DB12

1. BASE	2. POLE	3. OAH	4. COLOR	5. OPTIONS/ACCESSORIES				

1. BASE	2. POLE	3. OAH	SHAFT	WT	MAXIMUM ALLOWABLE EPA (MPH)													
					85	90	100	110	120	130	140	150						
DB12	4R10-125	10' (3.1m)	4" RD x .125"	55	19.4	17.1	13.5	10.8	8.9	7.4	6.3	5.5						
DB12	4R12-125	12' (3.7m)	4" RD x .125"	59	15.3	13.4	10.5	8.3	6.7	5.6	4.7	4.0						
DB12	4R14-125	14' (4.3m)	4" RD x .125"	63	12.3	10.7	8.2	6.3	5.0	4.1	3.4	2.9						
DB12	4R16-125	16' (4.9m)	4" RD x .125"	66	10.0	8.6	6.4	4.8	3.6	2.9	2.4	2.0						
DB12	4R10-226	10' (3.1m)	4" RD x .226"	68	23.8	21.0	16.7	13.5	11.1	9.3	8.0	6.9						
DB12	4R12-226	12' (3.7m)	4" RD x .226"	74	19.2	16.9	13.3	10.6	8.6	7.2	6.1	5.3						
DB12	4R14-226	14' (4.3m)	4" RD x .226"	80	15.9	13.9	10.8	8.4	6.8	5.6	4.7	4.0						
DB12	4R16-226	16' (4.9m)	4" RD x .226"	87	12.4	12.3	9.4	7.3	5.7	4.7	4.0	3.3						
DB12	4R18-226	18' (5.5m)	4" RD x .226"	93	11.7	10.0	7.5	5.6	4.3	3.5	2.9	2.4						
DB12	4R20-226	20' (6.2m)	4" RD x .226"	99	9.5	8.1	5.9	4.2	3.1	2.4	1.9	1.6						
DB12	4F10-188	10' (3.1m)	4" FL x .188"	63	22.1	19.5	15.4	12.4	10.2	8.5	7.1	6.1						
DB12	4F12-188	12' (3.7m)	4" FL x .188"	68	17.6	15.4	12.1	9.6	7.7	6.4	5.3	4.4						
DB12	4F14-188	14' (4.3m)	4" FL x .188"	74	14.3	12.5	9.6	7.5	5.9	4.8	3.9	3.2						
DB12	4F16-188	16' (4.9m)	4" FL x .188"	79	11.7	10.1	7.6	5.8	4.4	3.5	2.7	2.2						

Note: Overall height is measured to top of pole.

SPECIFICATIONS

Base shall be cast aluminum #356 alloy, free of any porosity, foreign materials, or cosmetic fillers. Base casting shall be heat treated to a T-6 condition, and of uniform wall thickness, with no warping or mold shifting.

WARNINGS

Caution must be exercised in the selection of a design wind speed when the pole is to be installed in a special wind region (as indicated by the wind map) or in an area where wind speed is unpredictable.

AAL recommends consulting a local engineer when the pole is to be installed in an area that may be subject to extreme weather and exposure

Poles installed on structures such as buildings and bridges may be subjected to vibration, oscillations, and other fatigue effects which are not covered by the AAL warranty.

The use of banners or other appendages can severely affect the loading of a pole. No banner or other appendage should be attached to an AAL pole unless approved by AAL.

If the products are to be used on an existing foundation or on other structures, the customer assumes all responsibility for the structural integrity of the existing foundation, anchorage or structures and all the consequences arising therefrom.

CAUTION

Poles should never be erected without the luminaire installed. Warranty is voided if the pole is erected without the luminaire. The warranty is voided if the pole is not grouted under the entire base after installation.

Anchor bolts shall be hot dip galvanized steel. Eight galvanized hex nuts and flat washers, and a bolt circle template shall be provided. Anchor bolt for poles are 3/4" x 24" x 3".

CERTIFICATION

Certified UL 1598 in accordance with Article 410 of ANSI/NFPA 70, National Electrical Code.

2. COLOR

WH Arctic White	VBU Verde Blue
BL Black	CRT Corten
BLT Matte Black	MAL Matte Aluminum
DB Dark Bronze	MG Medium Grey
DGN Dark Green	AGN Antique Green
TT Titanium	LG Light Grey
WDB Weathered Bronze	RAL Premium Color
MDB Bronze Metallic	CUSTOM ** Contact Factory

3. OPTIONS / ACCESSORIES

- FH (Flag holder. Specify location on pole)
- FS1 (Single weatherproof fuse holder. Fuse by others.)
- FS2 (Double weatherproof fuse holder. Fuse by others.)
- LR (Ladder rest. Slips over a 4" O.D. pole.)
- PCA-T (Rotatable photocell housing. The housing slips over a 4"/100mm O.D. pole. A fixture slips over the 4"/100mm O.D. tenon. Includes an internal twist lock receptacle, and an access cover with integral lens and stainless steel tether. Adds 5"/125mm to the overall height of the pole/fixture assembly. Prewired on the load side and line side for easy installation. Photocell by others.)
- PCR (Low profile twist lock photocell receptacle with cast pole cap top. Secures to the top of the pole with three stainless steel set screws. Photocell by others.)
- PLT (Plant Hanger. For 4" O.D. poles. (specify location on pole)
- RBC (Cast aluminum receptacle housing, integrally welded to the pole. Includes a NEC approved clear weatherproof cover. Does not include a receptacle or internal wiring.)

JOB _____

TYPE _____

NOTES _____



4" ROUND (RD) & FLUTED (FL) DECORATIVE BASE

DIMENSIONS

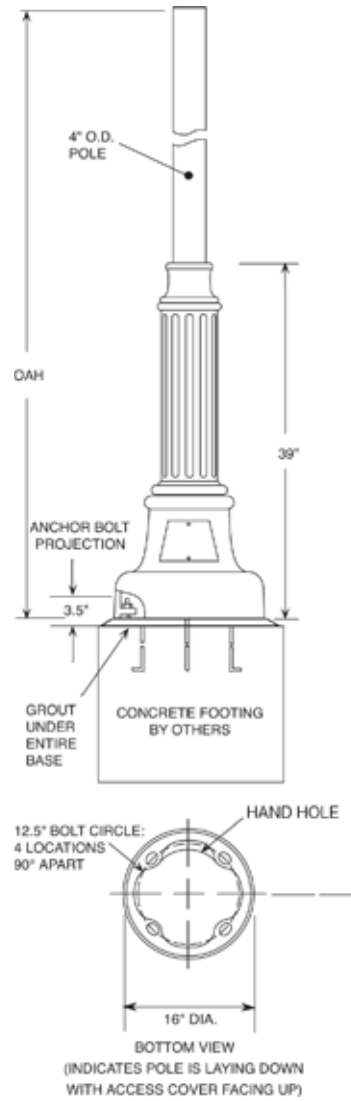

SLA24/SLA24(5)/SLA24-2/SLA24(5)-2 – Contemporary Arms | TYPE

TYPES S1, S1A



SLA24

1. ARM

2. COLOR

1. ARM

- SLA24 (Slip over a 4" pole. Weight: 9 lbs. EPA: .85)
- SLA24(5) (Slip over a 5" pole. Weight: 11 lbs. EPA: 1.17)
- SLA24-2 (Twin arms. Slip over a 4" pole. Weight: 14 lbs. EPA: 1.59)
- SLA24(5)-2 (Twin arms. Slip over a 5" pole. Weight: 16 lbs. EPA: 1.81)

2. COLOR

- | | |
|----------------------|---------------------------|
| WH Arctic White | VBU Verde Blue |
| BL Black | CRT Corten |
| BLT Matte Black | MAL Matte Aluminum |
| DGN Dark Green | → MG Medium Grey |
| DB Dark Bronze | AGN Antique Green |
| WDB Weathered Bronze | LG Light Grey |
| MDB Bronze Metallic | RAL Premium Color |
| | CUSTOM ** Contact Factory |

DIMENSIONS

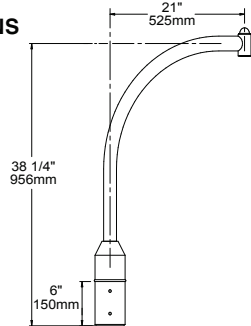

→ SLA24 (4" pole)

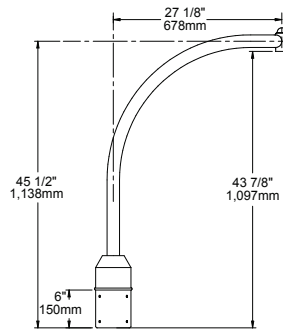

SLA24(5) (5" pole)

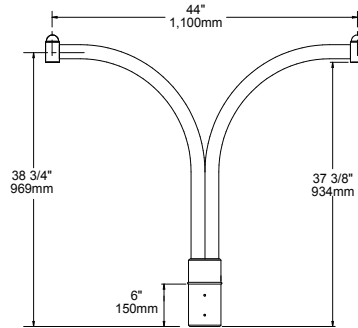

SLA24-2 (4" pole)

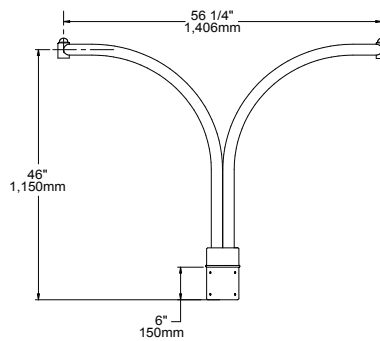

SLA24(5)-2 (5" pole)

SPECIFICATIONS

The arms shall be of one piece unitized aluminum construction, fully welded and assembled. The slip fitter shall be cast aluminum with an internal wireway and pole stop. The arm shall be prewired with a quick connector for easy installation.

The arms shall have a cast aluminum fitter welded to the top of the arm(s) for attaching the fixture. The fixture shall be mounted with three stainless steel bolts through the top of the arm fitter into the fixture. The attachment point shall have a silicone pad for sealing the fixture to arm connection.

The arm shall slip over a 4"/100mm or 5"/125mm diameter pole or tenon. The cast aluminum slip fitter shall have six stainless steel cup point set screws for securing the arm to the pole or tenon.

JOB _____
 TYPE _____
 NOTES _____





CSX2 LED

LED Area Luminaire



Catalog Number **CSX2 LED 120C 1000 40K T4M MVOLT RPA DDBXD**

Notes

Type **TYPE S3**

Hit the Tab key or mouse over the page to see all interactive elements.

Introduction

The Contour® Series luminaires offer traditional square dayforms with softened edges for a versatile look that complements many applications.

The CSX2 combines the latest in LED technology with the familiar aesthetic of the Contour® Series for stylish, high-performance illumination that lasts. It is ideal for replacing traditional metal halide in area lighting applications with typical energy savings of 65% and expected service life of over 100,000 hours.

Specifications

EPA: 1.2 ft²
(0.11 m²)

Length: 34-1/3"
(87.1 cm)

Width: 18-1/2"
(46.9 cm)

Height: 5-3/4"
(14.6 cm)

Weight (max): 59 lbs
(26.8 kg)

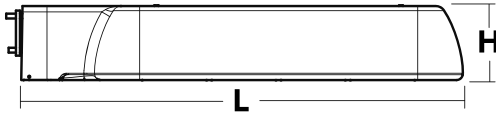

Ordering Information

EXAMPLE: CSX2 LED 120C 1000 40K T5M MVOLT SPA DDBXD

CSX2 LED	120C	Drive current		Color temperature		Distribution		Voltage	Mounting	Options	Finish (required)
CSX2 LED	120C	120 LEDs	700 700 mA 1000 1000 mA (1 A)	40K 4000 K 50K 5000 K	T2M Type II T3M Type III T4M Type IV T5M Type V TFTM Forward throw	MVOLT ¹ 120 ¹ 208 ¹ 240 ¹ 277 ¹ 347 480	Shipped included SPA Square pole mounting RPA Round pole mounting WBA Wall bracket Shipped Separately ² SPUMBA Square pole universal mounting adaptor ³ RPUMBA Round pole universal mounting adaptor ³ KMA8 Mast arm mounting bracket adaptor (specify finish) ⁴ DDBXD U	Shipped installed PER NEMA twist-lock receptacle only (no controls) DCR Dimmable and controllable via ROAM® (no controls) ⁵ DMG 0-10V dimming driver (no controls) HS House-side shield ² SF Single fuse (120, 277, 347V) ⁶ DF Double fuse (208, 240, 480V) ⁶ DS Dual switching ^{7,8} BL30 Bi-level switched dimming, nominal 30% ^{9,9} BL50 Bi-level switched dimming, nominal 50% ^{9,9} Shipped separately ² VG Vandal guard BS Bird-deterrent spikes	DDBXD Dark bronze DBLXD Black DNAXD Natural aluminum DWHXD White DDBTXD Textured dark bronze DBLBXD Textured black DNATXD Textured natural aluminum DWHGXD Textured white		

Accessories

Ordered and shipped separately.

DLL127F 1.5 JU	Photocell - SSL twist-lock (120-277V) ¹⁰
DLL347F 1.5 CUL JU	Photocell - SSL twist-lock (347V) ¹⁰
DLL480F 1.5 CUL JU	Photocell - SSL twist-lock (480V) ¹⁰
SC U	Shorting cap ¹⁰
KMA8 DDBXD U	Mast arm mounting bracket adaptor (specify finish) ⁴
PUMBA DDBXD U*	Round and square pole universal mounting bracket adaptor (specify finish)
CSX2HS U	House-side shields (includes 4 shields)
CSX2VG U	Vandal guard accessory
CSX2BS U	Bird-deterrent spikes accessory

For more control options, visit [DTL](#) and [ROAM](#).

Drilling

CSX2 shares a unique drilling pattern with the AERIS™ family. Specify this drilling pattern when specifying poles.

DM19AS Single unit
DM29AS 2 at 90°*
DM28AS 2 at 180°*
DM39AS 3 at 90°*
DM49AS 4 at 90°**
DM32AS 3 at 120°**

Example: SSA 20 4C DM19AS DDBXD

* Round pole requires 3.25" O.D. minimum.

** For round pole mounting (RPA) only.

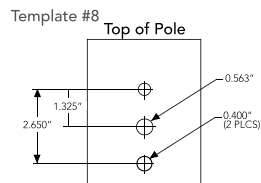

Tenon Mounting Slipfitter**

Tenon O.D.	Single Unit	2 at 180°	2 at 90°	3 at 120°	3 at 90°	4 at 90°
2-3/8"	AST20-190	AST20-280	AST20-290	AST20-320	AST20-390	AST20-490
2-7/8"	AST25-190	AST25-280	AST25-290	AST25-320	AST25-390	AST25-490
4"	AST35-190	AST35-280	AST35-290	AST35-320	AST35-390	AST35-490

NOTES

- MVOLT driver operates on any line voltage from 120-277V (50/60 Hz). Specify 120, 208, 240 or 277 options only when ordering with fusing (SF, DF options).
- Also available as a separate accessory; see Accessories information at left.
- 1.5 G vibration load rating per ANCI C136.31.
- Requires "SPA" mounting option. Must be ordered as a separate accessory; see Accessories information. For use with 2-3/8" mast arm (not included).
- Specifies a ROAM® enabled luminaire with 0-10V dimming capability; PER option required. Not available with 347 or 480V. Additional hardware and services required for ROAM® deployment; must be purchased separately. Call 1-800-442-6745 or email: sales@roamservices.net. N/A with BL30, BL50, or DS.
- Single fuse (SF) requires 120, 277 or 347 voltage option. Double fuse (DF) requires 208, 240 or 480 voltage option.
- Provides 50/50 luminaire operation via two independent drivers on two separate circuits. N/A with PER or DCR.
- Requires an additional switched line.
- Dimming driver standard. MVOLT only. Not available with DCR.
- Requires luminaire to be specified with PER option. Ordered and shipped as a separate line item.



Performance Data

Lumen Output

Lumen values are from photometric tests performed in accordance with IESNA LM-79-08. Data is considered to be representative of the configurations shown, within the tolerances allowed by Lighting Facts. Contact factory for performance data on any configurations not shown here.

LEDs	Drive Current (mA)	Performance Package	System Watts	Dist. Type	40K (4000 K, 70 CRI)					50K (5000 K, 67 CRI)				
					Lumens	B	U	G	LPW	Lumens	B	U	G	LPW
120C (120 LEDs)	700 mA	120C 700 --K	268W	T2M	26,094	3	0	4	97	28,107	3	0	4	105
				T3M	27,757	3	0	4	104	29,897	3	0	4	112
				T4M	27,658	3	0	4	103	29,792	3	0	5	111
				T5M	28,025	5	0	4	105	30,186	5	0	4	113
				TFTM	28,304	3	0	4	106	30,487	3	0	4	114
	1000 mA	120C 1000 --K	416W	T2M	34,700	4	0	4	83	37,406	4	0	5	90
				T3M	36,910	4	0	5	89	39,789	4	0	5	96
				T4M	36,780	3	0	5	88	39,649	4	0	5	95
				T5M	37,267	5	0	4	90	40,174	5	0	5	97
				TFTM	37,638	3	0	5	90	40,574	3	0	5	98

Lumen Ambient Temperature (LAT) Multipliers

Use these factors to determine relative lumen output for average ambient temperatures from 0-40°C (32-104°F).

Ambient		Lumen Multiplier
0°C	32°F	1.02
10°C	50°F	1.01
20°C	68°F	1.00
25°C	77°F	1.00
30°C	86°F	1.00
40°C	104°F	0.99

Projected LED Lumen Maintenance

Data references the extrapolated performance projections for the CSX2 LED 120C platform in a 25°C ambient, based on 10,000 hours of LED testing (tested per IESNA LM-80-08 and projected per IESNA TM-21-11).

To calculate LLF, use the lumen maintenance factor that corresponds to the desired number of operating hours below. For other lumen maintenance values, contact factory.

Operating Hours	0	25,000	50,000	100,000
Lumen Maintenance Factor	1.0	0.94	0.90	0.83

Electrical Load

Number of LEDs	Drive Current (mA)	System Watts	Current (A)					
			120V	208V	240V	277V	347V	480V
120C	700	268W	2.643	1.511	1.318	1.159	0.923	0.674
	1000	416W	4.135	2.397	2.111	1.886	1.527	1.210

Photometric Diagrams

To see complete photometric reports or download .ies files for this product, visit Lithonia Lighting's [CSX2 homepage](#).

Isofootcandle plots for the CSX2 LED 120C 1000 40K. Distances are in units of mounting height (30').

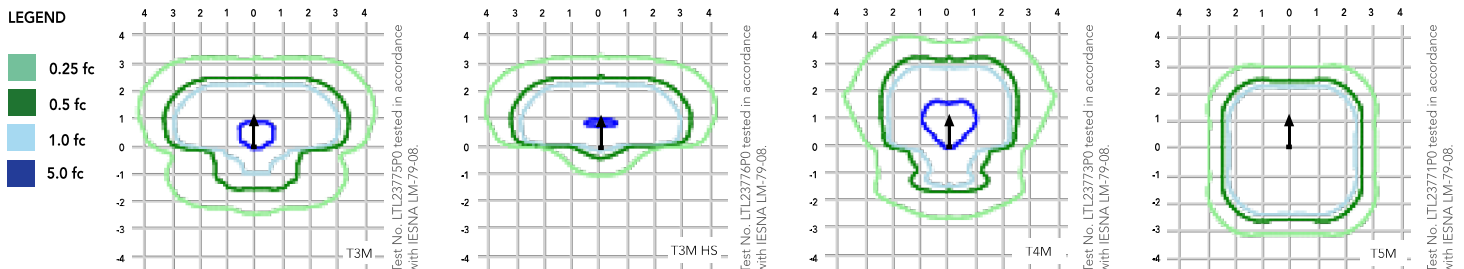

FEATURES & SPECIFICATIONS

INTENDED USE

The Contour Series LED area luminaire is ideal for streets, walkways, parking lots, and surrounding areas that call for high-performance LED lighting in a transitional dayform.

CONSTRUCTION

Single-piece die cast housing has a unique flow-through design that allows for optimized thermal management through convective cooling. A metallic screen covers the top of the housing, preventing debris build-up while allowing natural cleaning of the heat sinks. Modular design allows for ease of maintenance and future light engine upgrades. The LED driver(s) and electronics are thermally isolated from the light engines, ensuring long life. Housing is completely sealed against moisture and environmental contaminants.

FINISH

Exterior parts are protected by a zinc-infused Super Durable TGIC thermoset powder coat finish that provides superior resistance to corrosion and weathering. A tightly controlled multi-stage process ensures a minimum 3 mils thickness for a finish that can withstand extreme climate changes without cracking or peeling.

OPTICS

Precision-molded acrylic lenses provide optimal luminaire spacing and improved uniformity. Lenses are indexed to the circuit board to ensure consistent optical alignment and delivering repeatable photometric performance. Light engines are available in standard 4000 K (70 CRI) or optional 5000 K (67 CRI) configurations. The CSX2 has zero uplight and qualifies as a Nighttime Friendly™ product, meaning it is consistent with the LEED® and Green Globes™ criteria for eliminating wasteful uplight.

ELECTRICAL

Light engines consist of 120 high-efficacy LEDs mounted to metal-core circuit boards to maximize heat dissipation and promote long life (100,000 hrs at 40°C, L70). Class 1 electronic driver

designed to have a power factor >90%, THD <20%, with an expected life of 100,000 hours with <1% failure rate. Easily-serviceable surge protection device meets a minimum Category C Low operation (per ANSI/IEEE C62.41.2).

INSTALLATION

Integral arm provides easy installation to a pole and assists in alignment and leveling. Secure connection withstands up to 2.0 G vibration load rating per ANSI C136.31. The CSX2 utilizes the AERIS™ series pole drilling pattern for SPA and RPA options.

LISTINGS

CSA Certified to U.S. and Canadian standards. Light engines are IP66 rated. Luminaire is IP65 rated. **U.S. Patent No. D632830. U.S. Patent No. D653,382 S.**

DesignLights Consortium® (DLC) qualified product. Not all versions of this product may be DLC qualified. Please check the DLC Qualified Products List at www.designlights.org to confirm which versions are qualified.

WARRANTY

Five year limited warranty. Full warranty terms located at www.acuitybrands.com/CustomerResources/Terms_and_conditions.aspx.

Note: Actual performance may differ as a result of end-user environment and application. All values are design or typical values, measured under laboratory conditions at 25 °C. Specifications subject to change without notice.



FEATURES & SPECIFICATIONS

INTENDED USE — Round straight aluminum general purpose pole for up to 30 foot mounting heights.

CONSTRUCTION — Shaft: One-piece extruded 6063-T6 aluminum alloy with T6 temper. Circumferential satin-brushed finish. Round straight tube is uniform in cross-section down length of shaft with no taper.

Anchor base: Cast from A356 aluminum alloy and heat treated to T6 temper. Base plate and shaft are circumferentially welded top and bottom. The anchor base is provided with slotted holes.

Handhole: Handhole is located 18" above base (poles have either 2" x 4" or 3" x 5" handhole). Cover and attachment hardware furnished.

Hardware: Stainless steel

Top cap: Removable top cap provided with drill-mount poles.

Bolt covers: A356 bolt covers included with anchor base unless otherwise specified. Spun aluminum base cover available as an option.

Finish: Must specify finish.

Grounding: Provision located inside handhole rim. Grounding hardware is not included (provided by others).

Anchor bolts: Fabricated from carbon steel bar with minimum-yield strength of 55,000 psi. Upper portion of anchor bolt is galvanized per ASTM A-153. Each anchor bolt is furnished with two hex nuts and two flat washers.

WARRANTY — 1-year limited warranty. Complete warranty terms located at www.acuitybrands.com/CustomerResources/Terms_and_conditions.aspx

Note: Specifications subject to change without notice.

Actual performance may differ as a result of end-user environment and application.

Catalog Number	RSA 25 6E DM19AS DDBXD
Notes	
Type	TYPE S3



Anchor Base Poles

RSA

ROUND STRAIGHT ALUMINUM

ORDERING INFORMATION

Lead times will vary depending on options selected. Consult with your sales representative.

Example: RSA 16 4-5C DM19 BA

RSA Series	Nominal fixture mounting height	Nominal shaft base size/wall thickness	Mounting ¹	Options	Finish ¹⁰
RSA	8 – 30 feet (See back page.)	(See back page.)	Tenon mounting PT Open top T20 2-3/8" O.D. (2" NPS) T25 2-7/8" O.D. (2-1/2" NPS) T30 3-1/2" O.D. (3" NPS) ² T35 4" O.D. (3-1/2" NPS) ² Drill mounting³ DM19 1 at 90° DM28 2 at 180° DM28PL 2 at 180° with one side plugged DM29 2 at 90° DM32 3 at 120° DM39 3 at 90° DM49 4 at 90° CSX/DSX/AERIS™/OMERO™ Drill mounting³ DM19AS 1 at 90° DM28AS 2 at 180° DM29AS 2 at 90° DM32AS 3 at 120° DM39AS 3 at 90° DM49AS 4 at 90° AERIS™ Suspend drill mounting^{3,4} DMxxAST_ OMERO™ Suspend drill mounting^{3,4} DMxxMRT_	Shipped installed L/AB Less anchor bolts FBC Full base cover VD Vibration damper TP Tamper proof H1-18A Horizontal arm bracket (1 fixture) ^{5,6} FDLxx Festoon outlet less electrical ⁵ CPL12xx 1/2" coupling ⁵ CPL34xx 3/4" coupling ⁵ CPL1xx 1" coupling ⁵ NPL12xx 1/2" threaded nipple ⁵ NPL34xx 3/4" threaded nipple ⁵ NPL1xx 1" threaded nipple ⁵ EHHxx Extra handhole ^{5,7} MAEX Match existing ⁸ USPOM United States point of manufacture ⁹	Standard colors DDB Dark bronze DWH White DBL Black DMB Medium bronze DNA Natural aluminum BA Brushed aluminum Classic colors DSS Sandstone DGC Charcoal gray DTG Tennis green DBR Bright red DSB Steel blue Class 1 architectural anodized ABL Black ADB Dark bronze ANA Natural

NOTES

- When ordering tenon mounting and drill mounting for the same pole, follow this example: DM28/T20. The combination includes a required extra handhole.
- T30 and T35 tenons available on 5" and 6" shafts only.
- The drilling template to be used for a particular luminaire depends on the luminaire that is used. Refer to the Technical Data Section of the Outdoor Binder for Drilling Templates.
- Insert "1" or "2" to designate fixture size; e.g. DM19AST2.
- Specify location and orientation when ordering option. For 1st "x": Specify the height in feet above base of pole. Example: 5ft = 5 and 20ft = 20
For 2nd "x": Specify orientation from handhole (A,B,C,D) Refer to the handhole Orientation diagram on this page.
- Horizontal arm is 18" x 2-3/8" O.D. tenon standard.
- Combination of tenon-top and drill mount includes extra handhole.
- Must add original order number
- Use when mill certifications are required.
- Finish must be specified. Additional colors available; see www.lithonia.com/archcolors or Architectural Colors brochure (Form No. 794.3).

HANDHOLE ORIENTATION

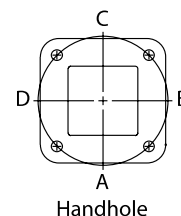

IMPORTANT INSTALLATION NOTES:

- Do not erect poles without having fixtures installed.
- Factory-supplied templates must be used when setting anchor bolts. Lithonia Lighting will not accept claim for incorrect anchorage placement due to failure to use factory template.
- If poles are stored outside, all protective wrapping must be removed immediately upon delivery to prevent finish damage.
- Lithonia Lighting is not responsible for the foundation design.

RSA Round Straight Aluminum Poles

TECHNICAL INFORMATION										
Catalog Number	Nominal mount ht. (ft)	Pole Shaft Size (in x ft)	Wall Thick (in)	EPA (ft2) with 1.3 gust			Max. weight (lbs)	Bolt Circle (in)	Bolt Size (in. x in. x in.)	Approximate ship (lbs.)
				80 mph	90 mph	100 mph				
RSA 8 4C	8	4 x 8	0.125	11.2	8.6	6.8	125	6-1/2-8-1/4	3/4 x 18 x 3	22
RSA 8 4-5C	8	4-1/2 x 8	0.125	14.6	11.3	9.1	175	7-1/8-8-3/8	3/4 x 18 x 3	30
RSA 8 4-5G	8	4-1/2 x 8	0.188	21.8	17	13.7	225	7-1/8-8-3/8	3/4 x 18 x 3	38
RSA 10 4C	10	4 x 10	0.125	8.2	6.1	4.7	100	6-1/2-8-1/4	3/4 x 18 x 3	26
RSA 10 4-5C	10	4-1/2 x 10	0.125	10.6	8.1	6.5	133	7-1/8-8-3/8	3/4 x 18 x 3	34
RSA 10 4-5G	10	4-1/2 x 10	0.188	16.3	12.6	10.1	175	7-1/8-8-3/8	3/4 x 18 x 3	43
RSA 10 5C	10	5 x 10	0.125	13.6	10.6	8.5	150	7-1/2-9-1/2	3/4 x 18 x 3	36
RSA 12 4C	12	4 x 12	0.125	6	4.3	3.2	110	6-1/2-8-1/4	3/4 x 18 x 3	30
RSA 12 4-5C	12	4-1/2 x 12	0.125	8.1	6	4.8	80	7-1/8-8-3/8	3/4 x 18 x 3	38
RSA 12 4-5G	12	4-1/2 x 12	0.188	12.7	9.7	7.7	185	7-1/8-8-3/8	3/4 x 18 x 3	50
RSA 12 5C	12	5 x 12	0.125	10.3	8	6.3	150	7-1/2-9-1/2	3/4 x 18 x 3	36
RSA 12 5E	12	5 x 12	0.156	13.2	10.3	8.2	200	7-1/2-9-1/2	3/4 x 18 x 3	44
RSA 12 5G	12	5 x 12	0.188	16.2	12.6	10.1	225	7-1/2-9-1/2	3/4 x 18 x 3	53
RSA 14 4C	14	4 x 14	0.125	4.1	2.8	1.9	75	6-1/2-8-1/4	3/4 x 18 x 3	35
RSA 14 4-5C	14	4-1/2 x 14	0.125	5.8	4.2	3.3	60	7-1/8-8-3/8	3/4 x 18 x 3	39
RSA 14 4-5G	14	4-1/2 x 14	0.188	9.7	7.3	5.8	190	7-1/8-8-3/8	3/4 x 18 x 3	56
RSA 14 5C	14	5 x 14	0.125	7.8	6	4.7	100	7-1/2-9-1/2	3/4 x 18 x 3	42
RSA 14 5E	14	5 x 14	0.156	10.3	8	6.3	125	7-1/2-9-1/2	3/4 x 18 x 3	47
RSA 14 5G	14	5 x 14	0.188	12.8	9.9	7.9	150	7-1/2-9-1/2	3/4 x 18 x 3	56
RSA 16 4C	16	4 x 16	0.125	2.8	1.6	1	150	6-1/2-8-1/2	3/4 x 18 x 3	38
RSA 16 4-5C	16	4-1/2 x 16	0.125	4.2	2.8	2.1	50	7-1/8-8-3/8	3/4 x 18 x 3	46
RSA 16 4-5G	16	4-1/2 x 16	0.188	7.5	5.5	4.3	155	7-1/8-8-3/8	3/4 x 18 x 3	62
RSA 16 5C	16	5 x 16	0.125	5.9	4.4	3.4	175	7-1/2-9-1/2	3/4 x 18 x 3	46
RSA 16 5E	16	5 x 16	0.156	8	6.1	4.8	190	7-1/2-9-1/2	3/4 x 18 x 3	53
RSA 16 5G	16	5 x 16	0.188	10.1	7.8	6.1	200	7-1/2-9-1/2	3/4 x 18 x 3	60
RSA 16 6E	16	6 x 16	0.156	13.6	10.6	8.4	225	8-3/4-10-1/4	3/4 x 30 x 3	53
RSA 16 6G	16	6 x 16	0.188	16.8	13	10.4	245	8-3/4-10-1/4	3/4 x 30 x 3	78
RSA 18 5G	18	5 x 18	0.188	8	6.8	4.7	225	7-1/2-9-1/2	3/4 x 18 x 3	68
RSA 18 5C	18	5 x 18	0.125	4.3	3.1	2.4	150	7-1/2-9-1/2	3/4 x 18 x 3	48
RSA 18 5E	18	5 x 18	0.156	6.1	4.6	3.5	175	7-1/2-9-1/2	3/4 x 18 x 3	58
RSA 18 4-5G	18	4-1/2 x 18	0.188	5.7	4	3.1	123	7-1/8-8-3/8	3/4 x 18 x 3	68
RSA 18 6G	18	6 x 18	0.188	13.9	10.7	8.5	225	8-3/4-10-1/4	3/4 x 30 x 3	86
RSA 20 4-5G	20	4-1/2 x 20	0.188	4.3	2.9	2.1	95	7-1/8-8-3/8	3/4 x 18 x 3	74
RSA 20 5C	20	5 x 20	0.125	3	2.1	1.5	150	7-1/2-9-1/2	3/4 x 18 x 3	54
RSA 20 5E	20	5 x 20	0.156	4.7	3.4	2.6	150	7-1/2-9-1/2	3/4 x 18 x 3	68
RSA 20 5G	20	5 x 20	0.188	6.4	4.8	3.6	150	7-1/2-9-1/2	3/4 x 18 x 3	82
RSA 20 6E	20	6 x 20	0.156	9.3	7.1	5.5	175	8-3/4-10-1/4	3/4 x 30 x 3	95
RSA 20 6G	20	6 x 20	0.188	11.8	9.1	7.1	200	8-3/4-10-1/4	3/4 x 30 x 3	110
RSA 25 4-5G	25	4-1/2 x 25	0.188	1.3	--	--	100	7-1/8-8-3/8	3/4 x 18 x 3	89
RSA 25 6E	25	6 x 25	0.156	5.2	3.8	2.8	150	8-3/4-10-1/4	3/4 x 30 x 3	108
RSA 25 6G	25	6 x 25	0.188	7.1	5.3	4	150	8-3/4-10-1/4	3/4 x 30 x 3	128
RSA 30 6G	30	6 x 30	0.188	3.5	2.4	1.6	200	8-3/4-10-1/4	3/4 x 30 x 3	146

BASE DETAIL

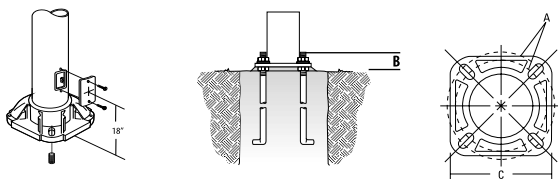

IMPORTANT:

• These specifications are intended for general purposes only. Lithonia Lighting reserves the right to change material or design, without prior notice, in a continuing effort to upgrade its products.

POLE DATA					
Shaft base size	Bolt circle A	Bolt projection B	Base square C	Template description	Anchor bolt description
4"	6-1/2" - 8-1/4"	3-1/4"	8-3/4"	ABTEMPLATE PJ50057	AB18-0
4-1/2"	7" - 8-3/8"	3-1/4"	8-1/2"	ABTEMPLATE PJ50040	AB18-0
5"	7-1/2" - 9-1/2"	3-1/4"	9-1/4"	ABTEMPLATE PJ50058	AB18-0
6"	8-3/4" - 10-1/4"	3-1/2"	10-1/4"	ABTEMPLATE PJ50059	AB30-0



POLE-RSA

SECTION 180170 LIGHTING CONTROLS

PART 1 - GENERAL

1.1 WORK INCLUDED

- A. The Work of this Section shall consist of the labor, materials and equipment required for furnishing and installing all lighting controls as specified herein.

1.2 SUBMITTALS

- A. Submit for approval in accordance with specified submittal procedures:
 1. All Lighting Control System components, including wiring and interconnecting diagrams of all items and equipment.
 2. Occupancy Sensors
 3. Photo Controls
 4. Emergency Lighting Relays
 5. Digital Lighting Control System

1.3 QUALITY CONTROL

- A. All occupancy sensors shall be of the same manufacturer, unless specified otherwise herein.
- B. Manufacturer shall have minimum 10 years' experience in manufacture of lighting controls.
- C. All units 100 percent tested prior to shipment.
- D. All applicable products shall be UL/cUL listed.

1.4 COORDINATION

- A. Building Management System Coordination
 1. Contractor shall coordinate exact requirements in order to facilitate communication between digital lighting control system and Owner's building management system.
- B. Digital Lighting Control System Programming
 1. Configuration of load and sensor behavior shall be specified by the building owner and communicated to the system manufacturer's field service technician prior to start up to enable the field service technician to program the digital lighting control system.

1.5 WARRANTY

- A. All devices and components specified herein shall be furnished with five-year manufacturer warranty.

PART 2 - PRODUCTS

2.1 OCCUPANCY SENSORS

- A. Occupancy Sensor Specification No. 1
 1. Acceptable Manufacturer: Watt Stopper PW-100 Series, Hubbell, Leviton, or as approved.
 2. The passive infrared sensor shall be a completely self-contained control system that replaces a standard toggle switch. Switching mechanism shall be a latching air gap relay, compatible with electronic ballasts, compact fluorescent, and inductive loads. Triac and other harmonic generating devices shall not be allowed. Sensor shall have ground wire and grounded strap for safety.
 3. Sensor shall be capable of detecting presence in the control area by detecting changes in infrared energy. Small movements shall be detected, such as when a person is writing while seated at a desk.
 4. Sensor shall utilize advanced control logic based on RISC (Reduced Instruction-Set Circuit) microcontroller.
 5. Detection Signature Processing (DSP) shall be used to avoid false offs and false activations and to provide immunity to RFI and EMI.
 6. Continuously adjusting Zero Cross relay control shall be used to guarantee reliable operation with non-linear loads (electronic, PL lamp ballasts) even with temperature changes and product aging.
 7. Sensor shall utilize SmartSet™ technology to optimize the sensor behavior to fit occupant usage patterns and adjust sensitivity and time delay to changing conditions. The use of SmartSet shall be selectable by user with a DIP switch.
 8. Sensor shall have a time off delay that is adjusted automatically (with the SmartSet setting) or shall have a fixed time off delay of 5, 10, 15, 20 or 30 minutes, walk-through mode, or test mode, set by DIP switch. In walk-through mode, lights shall turn off 3 minutes after the area is initially occupied if no motion is detected after the first 30 seconds.
 9. Sensor shall have the choice of light flash alert and/or audible alert of impending light shut off, selectable with DIP switch.
 10. Sensor shall have sensitivity adjustment that is set to either automatic (SmartSet setting) or reduced sensitivity, and is set with DIP switch.
 11. Sensor shall have a built-in light level feature, adjustable from 2 to 200 footcandles, selectable with DIP switch. During set up of light level control, sensor shall learn desired hold-off level, requiring only one step.
 12. Sensor shall have automatic-ON or manual-ON operation adjustable with DIP switch.

13. Sensor shall have no minimum load requirement and shall be capable of switching 0 to 800 watts fluorescent/incandescent at 120VAC, 0 to 1200 watts fluorescent at 277VAC, or 1/6 HP at 277VAC, 60 Hz.
14. Sensor shall utilize a temperature compensated, dual element sensor, and a multi-element Fresnel lens.
15. For vandal resistance, Fresnel lens shall be made of hard, 1.0mm Poly IR 2 material that offers greater sensitivity to motion and superior detection performance. Lens shall have grooves facing in to avoid dust and residue build up which affects IR reception.
16. Sensor shall cover up to 300 sq. ft. for walking motion, with a field of view of 180 degrees.
17. Adjustments and mounting hardware shall be concealed under a removable, tamper resistant cover to prevent tampering of adjustments and hardware.
18. Sensor shall have a 100 percent off switch with no leakage current to the load.
19. Input voltage: 120/277VAC, 60Hz.
20. UL and cUL listed.

2.2 PHOTO CONTROLS

A. Photo Control Specification No. 1 – Surface Mount

1. Acceptable Manufacturer: Precision Lumatrol T Series, or as approved.
2. Die cast aluminum vandal proof housing.
3. Weatherproof housing, hermetically sealed light sensitive element.
4. Field adjustable light level of 1 to 10 footcandles.
5. Standard turn on at 1.5 footcandles.
6. Turn on, turn off differential of .5 to 1 foot-candle.
7. Minimum time delay of 15 seconds.
8. Contact position at night, normally closed. Single pole, single throw.
9. Temperature Range: Minus 40 degrees F. to 170 degrees F.
10. Standard pipe thread nipple.
11. 1800 VA rating, voltage as required.
12. If a defect develops in the light sensitive element, the control shall move to and remain in the closed position.

2.3 EMERGENCY LIGHTING RELAY

A. Emergency Lighting Relay Specification No. 1

1. Acceptable Manufacturer: Wattstopper ELCU-200, or as approved.
2. Relay unit shall provide all functionality required to allow standard lighting control device to control emergency lighting in conjunction with normal lighting in a building. Unit

shall monitor single circuit that provides normal lighting to an area. As long as normal power is available, unit shall permit control devices to control emergency lighting fixtures. Upon loss of power, unit shall bypass control device and energize emergency fixtures.

3. Unit can be wired as control device (receives switching signal from relay, occupancy sensor, switch, etc.) or as a shunt (with dimming device).
4. Integral push-to-test.
5. Zero-cross switching technology.
6. LED indication for emergency and normal operation.
7. UL924 listed.
8. Unit shall meet all applicable NEC, OSHA, and NFPA requirements.
9. 120/277VAC.
10. Maximum load: 20A ballast load, 10A incandescent load, 1HP motor load.
11. Wire per manufacturer's recommendations.
12. Five year warranty.

2.4 DIGITAL LIGHTING CONTROL SYSTEM

A. Acceptable Manufacturer: WattStopper DLM System, or as approved.

B. System Description

1. Contractor shall furnish and install a plug-and-play, topology-free Digital Lighting Management (DLM) system as described herein to be wired, connected, and commissioned. System shall include all devices and equipment as defined in this section and all system components, cabling, and accessories as required for a fully-functioning, first-class lighting control system. System components shall include (but not be limited to):
 - a. Digital Switches: Self-configuring, digitally addressable pushbutton switches, dimmers, and scene switches with two-way active infrared (IR) communications.
 - b. Digital Occupancy Sensors: Self-configuring, digitally addressable and calibrated occupancy sensors with LCD display and two-way active infrared (IR) communications.
 - c. Digital Room Controllers: Self-configuring, digitally addressable one, two or three relay controllers, with 0-10 volt or forward phase control dimming outputs where required.
 - d. Digital Photo Sensors: Single-zone closed loop and multi-zone open loop daylighting sensors with two-way active infrared (IR) communications, able to provide switching, bi-level, tri-level or dimming control for daylight harvesting.
 - e. Digital Input/Output Interface: Device shall allow seamless integration with third party devices.
 - f. Configuration Tools: Handheld remote for room configuration to provide two way infrared (IR) communications to digital devices and allow complete configuration and reconfiguration of the device / room from up to 30 feet away. Unit shall have Organic LED display, pushbutton interface, and allow bi-directional communication of room variables and occupancy sensor settings.

- g. Computer Software: Personal computer software to allow customized room settings, installed and configured on Owner's equipment.
- h. Handheld Remote Controllers for Personal Control: One-button dimming, two-button on/off, or five-button scene remotes provide control using infrared communications. Remote controllers shall be configurable in the field to control selected loads or scenes without special tools.
- i. Digital Lighting Control Local Network: Free topology, plug-in wiring system using pre-configured or field fabricated Cat 5e Ethernet cables for power and data to room devices.

C. Digital Wall Or Ceiling-Mounted Occupancy Sensor

1. Acceptable Manufacturer: WattStopper LMDC (Ceiling) or LMDW (Wall) Series.
2. Wall or ceiling mounted (as indicated on Drawings) dual-technology occupancy sensor.
3. Furnish the manufacturer's system which accommodates the square-foot coverage requirements for each area controlled, utilizing room controllers, digital occupancy sensors and accessories which suit the lighting and electrical system parameters.
4. Digital Occupancy Sensors shall provide graphic LCD display for digital calibration and electronic documentation. Features include the following:
 - a. Digital calibration and pushbutton programming for the following variables:
 - 1) Sensitivity: 0-100% in 10% increments
 - 2) Time Delay: 1-30 minutes in 1 minute increments
 - 3) Test Mode: Five second time delay
 - 4) Walk-through mode
 - 5) Load parameters including Auto/Manual-ON, blink warning, and daylight enable/disable when photo sensors are included in the DLM local network.
 - b. One or two RJ-45 port(s) for connection to DLM local network.
 - c. Two-way infrared (IR) transceiver to allow remote programming through handheld commissioning tool and control by remote personal controls.
 - d. Device Status LEDs including:
 - 1) PIR detection
 - 2) Ultrasonic detection
 - 3) Configuration mode
 - 4) Load binding
 - e. Assignment of occupancy sensor to a specific load within the room without wiring or special tools.
 - f. Manual override of controlled loads.
5. Units shall not have any dip switches or potentiometers for field settings.
6. Multiple occupancy sensors may be installed in a room by simply connecting them to the free topology DLM local network. No additional configuration shall be required.

D. Digital Wall Stations

1. Acceptable Manufacturer: WattStopper LMSW or LMDM Series.
2. Low voltage momentary pushbutton switches in 1, 2, 3, 4, 5 and 8 button configuration.
3. Device color as directed by Owner.
4. Stations shall be compatible with standard decora-style wall plates.

5. Wall stations shall include the following features:
 - a. Two-way infrared (IR) transceiver for use with personal and configuration remote controls.
 - b. Removable buttons for field replacement with engraved buttons and/or alternate color buttons. Button replacement may be completed without removing the switch from the wall.
 - c. Red configuration LED on each switch that blinks to indicate data transmission.
 - d. Blue Load/Scene Status LED on each switch button with the following characteristics:
 - 1) Bi-level LED
 - 2) Dim locator level indicates power to switch
 - 3) Bright status level indicates that load or scene is active
 - e. Dimming switches shall include seven bi-level LEDs to indicate load levels using 14 steps.
6. Two RJ-45 ports for connection to DLM local network.
7. Multiple digital wall switches may be installed in a room by simply connecting them to the free topology DLM local network. No additional configuration shall be required to achieve multi-way switching.
8. The following switch attributes shall be capable of being changed or selected using a wireless configuration tool:
 - a. Load and Scene button function may be reconfigured for individual buttons (from Load to Scene, and vice versa).
 - b. Individual button function may be configured to Dim, Toggle, On only or Off only for any load or combination of loads.
 - c. Individual scenes may be locked to prevent unauthorized change.
 - d. Fade Up and Fade Down times for individual scenes may be adjusted from 0 seconds to 18 hours.
 - e. Ramp rate may be adjusted for each dimmer switch.
 - f. Switch buttons may be bound to any load on a room controller and are not load type dependent; each button may be bound to multiple loads.
 - g. Individual button may have varied programmable functions based upon time of day or occupied/unoccupied status.

E. Digital Room Controllers

1. Acceptable Manufacturer: WattStopper LMRC Series.
2. Room controllers shall automatically bind the room loads to the connected devices in the space without commissioning or the use of any tools. Room controllers shall be provided to match the room lighting load and control requirements. The controllers shall be simple to install and shall not have dip switches, potentiometers or require special configuration.
3. The control units shall include the following features:
 - a. Automatic room configuration to the most energy-efficient sequence of operation based upon the devices in the room.
 - b. Simple Replacement: Using the default automatic configuration capabilities, a room controller may be replaced with an off-the-shelf unit without requiring any configuration or setup.
 - c. Device Status LEDs to indicate:
 - 1) Data transmission
 - 2) Device has power

- 3) Status for each load
 - 4) Configuration status
 - d. Quick installation features including:
 - 1) Standard junction box mounting
 - 2) Quick low voltage connections using standard RJ-45 patch cable
 - e. Plenum rated.
 - f. Manual override and LED indication for each load
 - g. Dual voltage (120/277 VAC, 60 Hz), or 347 VAC, 60 Hz (selected models only)
 - h. Zero cross circuitry for each load.
4. On/Off Room Controllers shall include:
- a. One or two relay configuration
 - b. Efficient 150 mA switching power supply
 - c. Three RJ-45 DLM local network ports
5. On/Off/Dimming enhanced Room Controllers shall include:
- a. Real time current monitoring
 - b. Multiple relay configurations:
 - 1) One, two or three relays (LMRC-21x series)
 - 2) One or two relays (LMRC-22x series)
 - c. Efficient 250 mA switching power supply
 - d. Four RJ-45 DLM local network ports.
 - e. One dimming output per relay:
 - 1) Where indicated, one 0-10 volt analog output per relay for control of compatible ballasts and LED drivers. The 0-10 volt output shall automatically open upon loss of power to the Room Controller to assure full light output from the controlled lighting.
 - 2) Where indicated, one forward phase control line voltage dimming output per relay for control of compatible two-wire or three-wire ballasts, LED drivers, MLV, forward phase compatible ELV, neon/cold cathode and incandescent loads.
 - f. The following dimming attributes may be changed or selected using a wireless configuration tool:
 - 1) Establish preset level for each load from 0-100%
 - 2) Set high and low trim for each load
 - 3) Set lamp burn in time for each load up to 100 hours

F. Digital Photo Sensors

- 1. Acceptable Manufacturer: WattStopper LMLS-400 or LMLS-500 Series.
- 2. Provide open or closed loop photo sensors as recommended by system manufacturer for individual application.
- 3. Digital photo sensors work with room controllers to provide automatic switching, bi-level, or tri-level or dimming daylight harvesting capabilities for any load type connected to a room controller. Closed loop photo sensors shall measure the ambient light in the space and control a single lighting zone. Open loop photo sensors shall measure incoming daylight in the space, and are capable of controlling up to three lighting zones.
- 4. Photo sensors shall be interchangeable without the need for rewiring.
- 5. Digital photo sensors shall include the following features:

- a. An internal photodiode that measures only within the visible spectrum, and has a response curve that closely matches the photopic curve. The photodiode shall not measure energy in either the ultraviolet or infrared spectrums. The photocell shall have a sensitivity of less than 5% for any wavelengths less than 400 nanometers or greater than 700 nanometers.
 - b. Sensor light level range shall be from 1-6000 footcandles (fc).
 - c. The capability of ON/OFF, bi-level or tri-level switching, or dimming, for each controlled zone, depending on the selection of room controller(s) and load binding to room controller(s).
 - d. For switching daylight harvesting, the photosensor shall provide a field-selectable deadband, or a separation, between the "ON Setpoint" and the "OFF Setpoint" that shall prevent the lights from cycling excessively after they turn off.
 - e. For dimming daylight harvesting, the photosensor shall provide the option, when the daylight contribution is sufficient, of turning lights off or dimming lights to a field-selectable minimum level.
 - f. Optional wall switch override to allow occupants to reduce lighting level to increase energy savings or, if permitted by system administrator, raise lighting levels for a selectable period of time or cycle of occupancy.
 - g. Infrared (IR) transceiver for configuration and/or commissioning with a handheld configuration tool, to transmit detected light level to wireless configuration tool, and for communication with personal remote controls.
 - h. Red configuration LED that blinks to indicate data transmission.
 - i. Blue status LED indicates test mode, override mode and load binding.
 - j. Recessed switch to turn controlled load(s) ON and OFF.
 - k. One RJ-45 port for connection to DLM local network.
 - l. Any load or group of loads in the room can be assigned to a daylighting zone
 - m. Each load within a daylighting zone shall be capable of being individually enabled or disabled for discrete control (load independence).
6. Closed loop digital photo sensors shall include the following additional features:
 - a. An internal photodiode that measures light in a 100 degree angle, cutting off the unwanted light from bright sources outside of this cone.
 - b. Automatic self-calibration, initiated from the photosensor, a wireless configuration tool or a PC with appropriate software.
 - c. Automatically establishes application-specific setpoints following self-calibration. For switching operation, an adequate deadband between the ON and OFF setpoints shall prevent the lights from cycling; for dimming operation a sliding setpoint control algorithm with separate Day and Night setpoints shall prevent abrupt ramping of loads.
 7. Open loop digital photo sensors shall include the following additional features:
 - a. An internal photodiode that measures light in a 60 degree angle cutting off the unwanted light from the interior of the room.
 - b. Automatically establishes application-specific setpoints following manual calibration using a wireless configuration tool or a PC with appropriate software. For switching operation, an adequate deadband between the ON and OFF setpoints for each zone shall prevent the lights from cycling; for dimming operation, a proportional control algorithm shall maintain the design lighting level in each zone.
 - c. Each of the three discrete daylight zones can include any non-overlapping group of loads in the room.

G. Digital Input/Output Interface

1. Acceptable Manufacturer: Wattstopper LMIO-101 Series.
2. Input/Output interface for integration of third party devices such as building automation systems (BAS), time clocks, photo cells, etc.
3. 24VDC isolated relay (SPDT with normally open, normally closed, and common outputs) for output to other systems.
4. 24VDS output and four input terminals for maintained momentary switch closure inputs or third part logic inputs.
5. Status LED for each input and output.
6. Devices shall have two RJ45 ports.

H. Room Network

1. The DLM local network shall be a free topology lighting control physical connection and communication protocol designed to control a small area of a building. Digital room devices shall connect to the network using CAT 5e cables with RJ-45 connectors which provide both data and power to room devices. Features of the DLM local network shall include:
 - a. Plug n' Go automatic configuration and binding of occupancy sensors, switches and lighting loads to the most energy-efficient sequence of operation based upon the device attached.
 - b. Simple replacement of any device in the network with a standard off the shelf unit without requiring commissioning, configuration or setup.
 - c. Push n' Learn configuration to change the automatic configuration, including binding and load parameters without tools, using only the buttons on the digital devices in the local network.
 - d. Two-way infrared communications for control by handheld remotes, and configuration by a handheld tool including adjusting load parameters, sensor configuration and binding, within a line of sight of up to 30 feet from a sensor, wall switch or IR receiver.

I. Configurations Tools

1. A configuration tool shall facilitate optional customization of DLM local networks, and be used to set up open loop daylighting sensors. A wireless configuration tool shall feature infrared communications, while PC software shall connect to each local network via a USB interface.
2. Features and functionality of the wireless configuration tool shall include:
 - a. Two-way infrared (IR) communication with DLM IR-enabled devices within a range of approximately 30 feet.
 - b. High visibility organic LED (OLED) display, pushbutton user interface and menu-driven operation.
 - c. Read, modify and send parameters for occupancy sensors, daylighting sensors, room controllers and buttons on digital wall switches.
 - d. Save up to nine occupancy sensor setting profiles, and apply profiles to selected sensors.
 - e. Temporarily adjust light level of any load(s) on the local network, and incorporate those levels in scene setting.

- f. Adjust or fine-tune daylighting settings established during auto-commissioning, and input light level data to complete commissioning of open loop daylighting controls.

PART 3 - EXECUTION

3.1 INSTALLATION

A. Occupancy Sensors

1. Occupancy sensors shall be installed and wired per manufacturer's instructions.
2. Room and/or areas with occupancy sensors shall have the lighting in those rooms controlled using occupancy sensors. Electrical Contractor shall verify application and quantity of sensors with manufacturer based on type of space and coverage of each sensor type and add sensors, power packs, etc., of the types directed by the manufacturer in order to provide adequate detection throughout entire room.
3. Time-off delay times shall be set as directed by Owner.
4. Ultrasonic sensors shall be located a minimum of 4 feet away from air supply diffusers and 6 inch from power pack.
5. All wiring shall be tested prior to installation and connection of occupancy sensors.
6. Aiming of all directional occupancy sensors shall be as directed by the manufacturer.

B. Daylight Sensors

1. Daylight sensors shall not be mounted directly above direct/indirect pendant fixtures.
2. Final aiming and location of all daylight sensors shall be per manufacturer's recommendations.

C. Photo Controls

1. Photo controls shall be installed where indicated by Owner.
2. Photo controls installed on roof shall be mounted 2 feet above roof.
3. Where possible, photo controls shall be installed facing North. Exercise care when installing photo cells to ensure no source of artificial light will inadvertently turn photo control off.

3.2 TESTING

- A. Upon completion of all line, load and interconnection wiring, and after all fixtures are installed and lamped, a qualified factory representative shall completely check the installation prior to energizing the system. Each installed occupancy sensor shall be tested in the test mode to see that lights turn off and on based on occupancy.
- B. Test results shall be documented and tabulated for each sensor and shall include all settings. Three copies shall be turned over to Owner.

- C. At the time of checkout and testing, the owner's representative shall be thoroughly instructed in the proper operation of the system.

3.3 PROTECTION

- A. Contractor shall protect installed product and finished surfaces from damage during all phases of installation including preparation, testing, and cleanup.

3.4 SERVICE CONTRACT

- A. Electrical Contractor shall include in Base Bid the costs of and turn over to Owner a one year service contract. The service contract shall include two visits to the site during the period of the one year service contract, one visit at 3 months and the second visit near the end of the one year service contract. The visits shall be made by a manufacturer authorized representative knowledgeable of the products and the operation of the product. During each visit, the manufacturer's representative shall check each occupancy sensor for proper operation and make adjustments as necessary. All settings (sensitivity, time delays, etc.) shall be compared to initial settings and adjusted as required. Make adjustments and re-set as directed by Owner due to change in use of room, etc. Controls found to be non-operating, broken (other than miss-use), defective or not operating properly shall be replaced under the contract standard one year warranty at no cost to the Owner.
- B. Electrical contractor shall provide to Owner manufacturer's name and contact information to notify for the 3 months and near end of first year visits.

3.5 DIGITAL LIGHTING MANAGEMENT SYSTEM COMMISSIONING

- A. Upon completion of the installation, the system shall be commissioned by the manufacturer's factory authorized representative who shall verify a complete fully functional system.
- B. Upon completion of the system commissioning the factory-authorized technician shall visit site to set initial scenes and lighting levels, calibrate daylight sensors, and to provide the proper training to the owner's personnel on the adjustment and maintenance of the system.
- C. Electrical Contractor shall include in Base Bid all costs for commissioning of the control system and all components and devices by an authorized representative of the manufacturer. The Electrical Contractor shall assist the manufacturer's representative as required during the commissioning. The manufacturer's procedures and instructions shall be followed for the commissioning and shall include, as a minimum, the following:
 - 1. Prior to submission of shop drawings, the Electrical Contractor shall review with the manufacturer's authorized representative the physical details and proposed occupancy and usage of each area indicated to receive an occupancy sensor and the type and location of the lighting control device(s) in each area for approval by the manufacturer's representative. Each area shall be reviewed for sensor location and orientation relative to occupant location, room geometry, obstacles and false triggering. A letter from the manufacturer's authorized representative stating that the review has been completed and that locations and types of sensors in each area are approved shall be included with the shop drawing submittal. If, for any reason, the manufacturer's authorized representative

does not approve the sensor location or type for an area or areas, the letter shall include a listing of those areas, the reason for non-approval and recommendations for changes.

2. During construction and prior to device rough-in, the manufacturer authorized representative shall visit the site and approve the actual location of the occupancy sensor.
3. After installation, the manufacturer's authorized representative, in coordination with the Owner, shall adjust the functions, scheduling, sensitivity and time delays of each sensor and input device as best for the occupancy and usage of the area as described by the Owner. The adjustments and settings shall be based upon occupant(s) in and out for short periods of time, occupant(s) in most of the time and out for long periods of time, etc.
4. Electrical Contractor shall submit to Owner listing of each area indicating type of device in each area and device/sensor initial settings.

****END OF SECTION****

**SECTION 180180
SPECIAL SYSTEMS**

PART 1 - GENERAL

1.1 WORK INCLUDED

- A. The Work of this Section shall consist of the labor, materials, and equipment required for the furnishing and installing of special equipment specified herein.

PART 2 - EXECUTION

3.1 INSTALLATION

A. General

- 1. Install equipment and wiring to equipment in accordance with manufacturer's instructions.
- 2. Furnish and install suitable strain relief clamps and fittings for cord connections at outlet boxes and equipment connection boxes.

B. Electrically Operated Overhead Doors

- 1. Install and wire controls and furnish and install power wiring to door operators and control wiring from controls to door operators. Provide final connection of power wiring and control. Furnish, install and wire disconnect switches.

C. Shop Equipment

- 1. Furnish and install electrical terminating devices and wiring for electrical service to all equipment and terminate wiring. Equipment noted as plug-in will be furnished with cord and plug set. Equipment noted as direct type of connection shall be wired and connected as Work of Section 18.
- 2. Rigid steel conduit shall be used for all drops. Outlet boxes, junction boxes, etc., for terminating conduit drops shall not be mounted on equipment.

D. Laboratory Fume Hoods

1. Fume hood with integral lights and base stand with integral duplex receptacle and switch shall be furnished.
2. Electrical Contractor shall furnish and install wiring to light and wiring between switch and light.
3. Electrical Contractor shall furnish and install wiring to the duplex receptacle.

3.2 COORDINATION

- A. Before roughing in equipment, obtain verification from Owner for all equipment to be wired as Work of this Section as follows:
 1. Verify electrical loads of all equipment.
 2. Verify electrical characteristics of all equipment for compatibility with electrical power provided to the equipment.

END OF SECTION

SECTION 180190 CONTROLS AND INSTRUMENTATION

PART 1 - GENERAL

1.1 WORK INCLUDED

- A. The Work of this Section shall consist of the labor, materials and equipment required to furnish, install, and connect the control instrumentation equipment as specified herein.

1.2 SUBMITTALS

- A. Submit for approval in accordance with specified submittal procedures:
 - 1. Motor Starters

PART 2 - PRODUCTS

2.1 ACCEPTABLE MANUFACTURER

- A. Acceptable Manufacturer:
 - 1. Alternate Bid: Siemens Industry.
 - 2. Base Bid: Square D.

2.2 MOTOR STARTERS, MANUAL

- A. Manual Motor Starter Specification No. MN-1.
 - 1. Acceptable Manufacturer: Square D Class 2510, single-speed, and Class 2512 two-speed.
 - 2. Type: Manual motor starter with overloads, fractional horsepower.
 - 3. 120/240 volts AC, single phase.
 - 4. Surface mounted in unfinished spaces, flush mounted in finished spaces.
 - 5. NEMA 1 enclosure.
 - 6. Single speed, non-reversing.
 - 7. With or without pilot light, as indicated.
 - 8. Thermal overload protection in each ungrounded conductor.
 - 9. 1 or 2 pole as required. Switch shall break each ungrounded conductor.
 - 10. Handle guard/lock-off.
 - 11. Hand-off-automatic switch, where indicated.

2.3 COMBINATION MOTOR STARTERS

- A. General: Combination motor starters shall be:
1. Manufactured and rated in accordance with NEMA standards.
 2. Gravity drop-out.
 3. Solid state overload protection in each ungrounded conductor as specified herein.
 4. Suitable for addition of no less than four auxiliary contacts of any arrangement, normally open (NO) or normally closed (NC). One additional NO auxiliary contact shall be provided. If auxiliary contacts are not indicated, provide one NO contact.
 5. Single speed, non-reversing.
 6. Cover mounted manual reset.
 7. Suitable for two or three wire control.
 8. Heavy duty control devices for NEMA 1 enclosures, Control Device Specification No.1, as specified herein.
 9. Controls for other enclosures shall be suitable for the enclosure type, heavy duty.
 10. Unless otherwise indicated or specified, motor starters indicated as not being combination type shall be applicable starter type specified herein.
- B. Disconnect devices for combination motor starters shall include:
1. Fusible or non-fusible disconnect switch or circuit breaker type.
 2. Circuit breakers shall be as specified in Section 180120, Overcurrent Protective Devices, and disconnect switches shall be as specified in Section 180120, Disconnect Switches.
 3. Padlock type disconnect handle for locking in the off position for no more than three padlocks. Disconnect handle in continuous control of the disconnect switch or breaker.
 4. Enclosure door in the closed position to permit operation of disconnect.
 5. Enclosure door locking device when disconnect is in on position, unless a defeater is deliberately activated.
 6. Auxiliary normally open (NO) contact on disconnect.
 7. Unless noted otherwise, fuse clips, for Class R rejection type fuses in fusible disconnect switches.
- C. Refer to Drawings for the following starter requirements:
1. Starter type.
 2. NEMA size.
 3. NEMA enclosure.
 4. Ratings.
 5. Control and pilot devices.

6. Control voltage.
7. Control transformer, fused secondary. (Do not provide transformer if control transformer is not indicated.)
8. Other accessories and modifications.

D. Combination Motor Starter Specification No. CMS-1

1. Acceptable Manufacturer: Square D Class 8538 switch type non-reversing, Class 8539 breaker type non-reversing, Class 8738 switch type reversing, Class 8739 breaker type reversing.
2. Full voltage.
3. Single Speed.

2.4 EMERGENCY SHUT-DOWN PUSHBUTTON

- A. Acceptable Manufacturer: Safety Technology International, Inc. (STI) “SS-2”, or as approved.
- B. Stopper station.
- C. “Single pole change over” electrical arrangement (single pole - double throw) – push button, when activated, makes one set of contacts to open mechanically held contractor and key switch, when operated, resets stopper station and makes second set of contacts to close contractor.
- D. Push button inset to help stop accidental activation.
- E. Housing injection molded of a tough, durable polycarbonate.
- F. Pushbutton for power shutdown:
 1. Red housing, flush or surface mount as required.
 2. Larger outer octagon push button “stop”, key-to-reset.
 3. Label – “EMERGENCY POWER SHUTOFF”.
- G. Current carrying capacity – 5 amps, minimum.
- H. Contact rating – 15 amps minimum, 120.250 volt AC.
- I. Minimum operating life – 10,000 cycles.
- J. Contact material – plated brass.
- K. Two keys furnished with each station, all stations on project keyed alike.

PART 3 - EXECUTION

3.1 INSTALLATION

A. General

1. Install control and instrumentation equipment in accordance with equipment manufacturer's instructions. Submit manufacturer's printed installation instructions with operating and maintenance data at completion of Work.
2. Individually mounted motor starter shall be mounted 5 feet above finished floor.

****END OF SECTION****

**SECTION 180200
WIRING OF MECHANICAL EQUIPMENT**

PART 1 - GENERAL

1.1 WORK INCLUDED

- A. The Work of this Section shall include the labor, materials, and equipment required for furnishing and installing the power and control wiring of mechanical equipment. It shall not include control wiring specifically detailed as part of the building automation and automatic temperature control system specified in Section 160210, Building Automation System.

PART 2 - PRODUCTS

2.1 MATERIALS

- A. Mechanical Contractor(s) shall furnish equipment with controls, starters and related items as specified in various Sections of Divisions 12, 14, and 16.
- B. Where mechanical equipment is specified without starters or controllers, Electrical Contractor shall furnish and install same as specified herein.
- C. Electrical Contractor shall furnish and install all power wiring.
- D. Mechanical Contractor(s) shall furnish and install all control wiring.

PART 3 - EXECUTION

3.1 INSTALLATION

- A. Mechanical equipment shall be wired in accordance with the following schedule:

Key:

	Item furnished by ...
	Item installed by ...
	Item wired by ...

the respective trade according to the following designations:

- P = Plumbing Contractor
- H = HVAC Contractor
- E = Electrical Contractor
- O = Owner

Plumbing Equipment Wiring Schedule																	
Equipment		Disconnect Means				Controllers					Control Devices						
		Remote Disconnect Switch	Integral Disconnect Switch	Wall Switch	Cord & Plug	Magnetic Motor Str	Combination Motor Str	Manual Motor Str	VFD with Disconnect	Contactor	Line Voltage Stat	Low Voltage Stat	Aquastat	Duct Smoke Detector	Control Panel	Flow/Press/Level Switch	BAS/ATC Control
Gas Fired Water Heater DWH-1 & DWH-2	P							P									
	P							P									
	E							E									
Recirc. Pump CP-1	P											P					H
	P											P					H
	E											E					H
Air Compressor AC-1	P													P			
	P													P			
	E													E			
Air Dryer AD-1	P																
	P																
	E																
Electric Water Cooler EWC-1	P				P												
	P				P												
	E				E												

HVAC Equipment Wiring Schedule																	
Equipment	Disconnect Means					Controllers					Control Devices						
	Remote Disconnect Switch	Integral Disconnect Switch	Wall Switch	Cord & Plug		Magnetic Motor Str	Combination Motor Str	Manual Motor Str	VFD with Disconnect	Contactor	Line Voltage Stat	Low Voltage Stat	Aquastat	Duct Smoke Detector	Control Panel	Flow/Press/Level Switch	BAS/ATC Control
Air Handling Unit Fans, AHU-1 & AHU-2	H								H					E			H
	H								H					H			H
	E								E					E			H
Air Handling Unit Lights, AHU-1 & AHU-2	H		H														
	H		H														
	E		E														
Pumps, P-7 & P-10	H								H								H
	H								H								H
	E								E								H
Pumps, P-8 & P-9	H							E									H
	H							E									H
	E							E									H
Fan, F-1 Fume Hood	H		H	H				E									H
	H		H	H				E									H
	E		E	E				E									H
Fan, F-2 Range Hood	H		H	H													H
	H		H	H													H
	E		E	E													H

HVAC Equipment Wiring Schedule																	
Equipment	Disconnect Means					Controllers					Control Devices						
	Remote Disconnect Switch	Integral Disconnect Switch	Wall Switch	Cord & Plug		Magnetic Motor Str	Combination Motor Str	Manual Motor Str	VFD with Disconnect	Contactor	Line Voltage Stat	Low Voltage Stat	Aquastat	Duct Smoke Detector	Control Panel	Flow/Press/Level Switch	BAS/ATC Control
Fan, F-3 Slot Hood	H		H	E													
	H		H	E													
	E		E	E													
Fan, F4	H		H														
	H		H														
	E		E														
Unit Heater, UH-1	H		H														H
	H		H														H
	E		E														H
Wall Insert Heaters, WIH-1 & WIH-2	H		H														H
	H		H														H
	E		E														H
Weld Smoke Collectors, WSC-1, WSC-2 & WSC-3	H			E			E										
	H			E			E										
	E			E			E										
Fan Coil Unit, FC-1	H		H														H
	H		H														H
	E		E														H

HVAC Equipment Wiring Schedule																	
Equipment	Disconnect Means					Controllers					Control Devices						
	Remote Disconnect Switch	Integral Disconnect Switch	Wall Switch	Cord & Plug		Magnetic Motor Str	Combination Motor Str	Manual Motor Str	VFD with Disconnect	Contactor	Line Voltage Stat	Low Voltage Stat	Aquastat	Duct Smoke Detector	Control Panel	Flow/Press/Level Switch	BAS/ATC Control
Paint Spray Booth	H		H				E										H
	H		H				E										H
	E		E				E										H
Relocated Fume Hood Fan	O	O	O														H
	H	H	H														H
	E	E	E														H
Relocated Flexible Exhaust Hood Fan	O		E	E													
	H		E	E													
	E		E	E													

- B. Unless noted, Contractor responsible for wiring of an item shall be responsible for furnishing and installing all wiring for that item and making all connections associated with this wiring.
- C. Electrical Contractor shall furnish and install wiring from duct smoke detector to fire alarm panel. Mechanical Contractor shall furnish and install wiring from normally open auxiliary contact on duct smoke detector to control circuitry for shut down of equipment if duct smoke detector is activated.

END OF SECTION

Canopy Light

Our Canopy Light is a highly efficient fixture that is available for surface (CL Series) or recessed (RC Series) mounting. Offered in three sizes: 12", 16" or 22" square (12" & 16" square for recessed), all are standard with a high power factor ballast that will operate at -40°F (-40°C) HPS and -20°F (-29°C) MH.

Capacitor, starter and other electrical components are strategically located and heat sunk to the housing to increase their life

Internal ribbing structure to prevent any wall distortion or sagging

4kv rated porcelain lamp socket

DeltaGuard finish, featuring E-coat epoxy primer and acrylic powder topcoat

Aluminum die cast housing

*Canopy light
Typical
Cutaway*

Fluorescent or HID (metal halide or high pressure sodium) lamp supplied with each fixture

Precision specular reflector provides 78% efficiency and cutoff distribution for maximum light levels

Constant wattage high power factor ballast

Patented internal hinge assembly

Crystal #73 tempered glass lens standard on 12" and 16" fixtures. 22" Canopy Lights supplied with an acrylic drop lens

Captive stainless steel fasteners

Aluminum die cast door frame

Silicone gasket to assure a lifetime seal

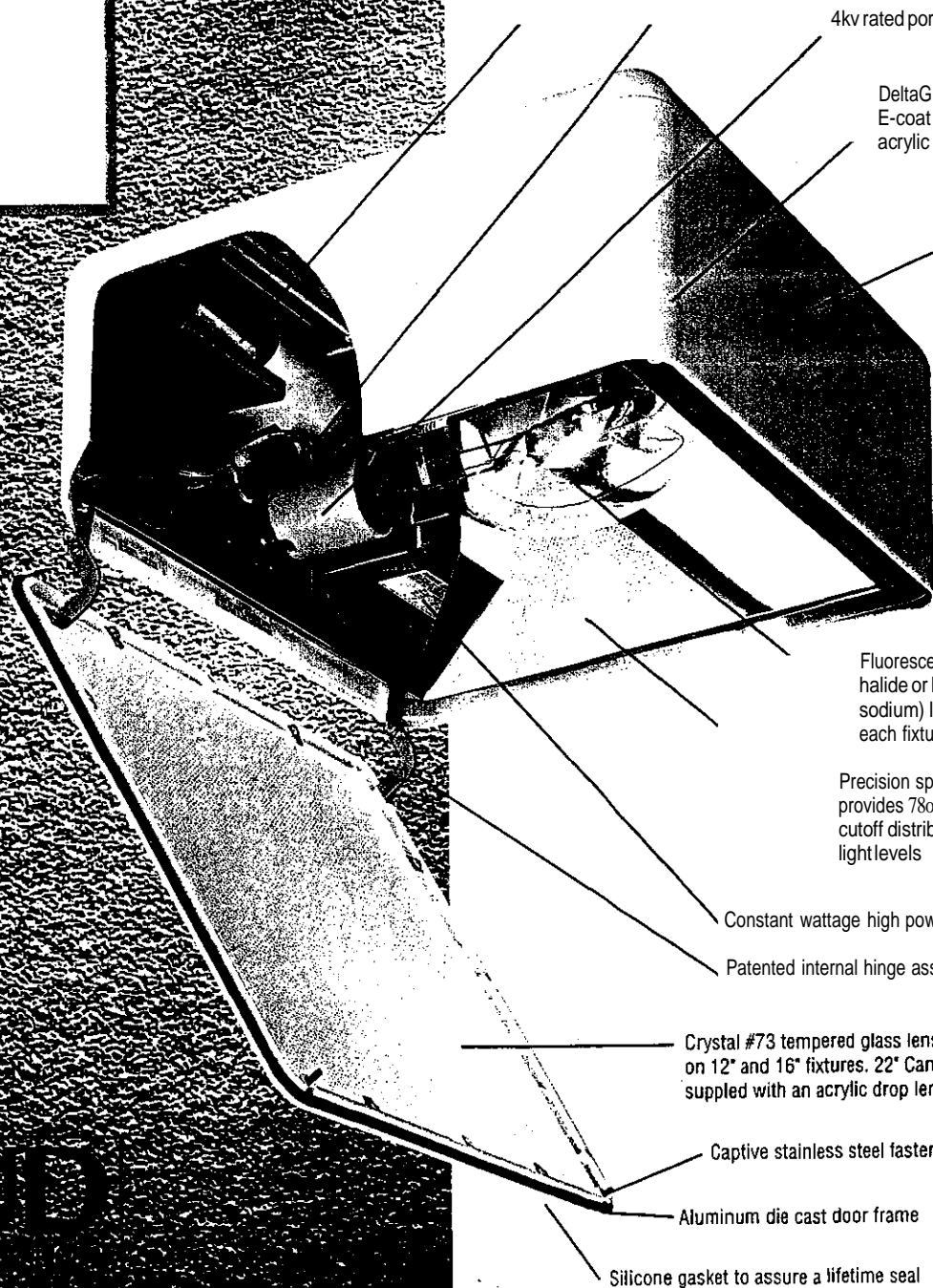

Canopy Light CL Series

Lamp Included!

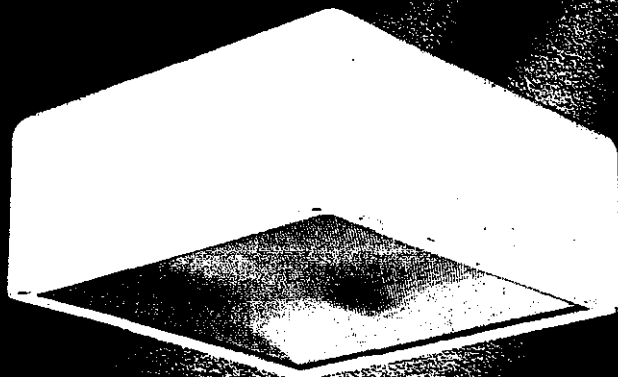

**CL0 Series
Direct Mount**



CL0 Series Direct Mount
2-1/4" deep acrylic drop
prismatic lens standard on 22"

Canopy Light Order Information

Housing Size (sq.)	Wattage/Lamp Type	Direct Mount	Quick Mount
12'	26W Fluorescent	MCL0226-1	MCL7226-1
12'	50W MH	MCL0405-0	MCL7405-0
12'	70W MH	MCL0407-0	MCL7407-0
12'	100W MH	MCL0410-0	MCL7410-0
12'	175W MH	MCL0417-M	MCL7417-M
16'	175W MH	CL0417-M	CL7417-M
16'	250W MH	CL0425-M	CL7425-M
22'	250W MH	CL0492-MA	not available
16'	400W MH	CL0440-M	CL7440-M
	400W MH	CL0494-MA	not available
12'	35W HPS	MCL0503-1	MCL7503-1
	50W HPS	MCL0505-D	MCL7505-0
12'	70W HPS	MCL0507-M	MCL7507-M
12'	100W HPS	MCL0510-M	MCL7510-M
12'	150W HPS	MCL0515-M	MCL7515-M
16'	250W HPS	CL0525-M	CL7525-M
22'	250W HPS	CL0592-MA	not available
16'	400W HPS	CL0540-M	CL7540-M
22'	400W HPS	CL0594-MA	not available

Options: (Factory-installed)	Change Suffix To	Add After Suffix
Description 120V Reactor ballast (50-150W HPS 12" housing only)	1	
2nv ballast (For 1 fluorescent)	2	
347V ballast (50W MH only) (Canada only)	6	

4BOV ballast (175-400W MH & 70-400W HPS only)	5	
Quad-volt ballast (50-100W MH only)	M	
Tri-volt ballast (70-400W MH & 7D-400W HPS)	T	
NOTE: In Canada, 50W fixtures supplied with Dual-volt (120V/2nv) ballast.		

Single Fuse* (120V, 277V or 347V)	1, 2 or 6	F
Dual Fuse** (20BV, 240V or 4BOV)	3, 4 or 5	F
e2-Level (250-400W HPS only) (120V, 277V 01.34N)	1, 2 or 6	H
Polycarbonate Drop Prismatic Lens (12' sq. housings only)		A
NOTE: n/a on 150W HPS & 175W MH. The lens is 1-3/4" deep. Tamperproof Lens Fasteners		
Quartz Standby (non delay-rela.) type (includes IOOW a Lamp)	0	

*Fixtures with factory-installed fuse supplied with single voltage ballast.

Accessories: (Field-installed) (Page 115)

Description	12" housing	16" housing	22" housing
Wire Guard	FWG-12	FWG-16	not available
Surface Box	SB-16	SB-16	SB-16

Housing

The seamless, die cast housing is standard with our DeltaGuard finish featuring an E-coat epoxy primer and white acrylic powder topcoat. Consult factory for availability of other finish colors.

Optics

Precision specular reflector provides 78% efficiency and cutoff distribution for maximum light levels. Lens enclosed in a hinged frame. Dn 12" and 16" sq. housings, a Crystal #73, tempered glass lens is standard. 22" sq. fixtures are supplied with an acrylic drop prismatic lens (2-1/4" deep).

Ballast

All fixtures are standard with a high power factor ballast. The 35W HPS and 26W Fluorescent fixtures are standard with a 120V ballast. The 50W fixtures are standard with a Dual-volt ballast (120/277V). In the U.S. all other fixtures are standard with a Quad-volt ballast (120/208/240/277V). In Canada 7Q-400W MH and 7Q-400W HPS fixtures are supplied with a Tri-volt ballast (120/277/347V), SOW fixtures are supplied with a Dual-volt ballast (120V/277V). See order information chart for additional ballast options.

Lamps

12" housing accommodates 26W quad tube compact fluorescent, medium base 50, 70, 100 or 175W MH and 35, 50, 70, 100 or 150W HPS lamps. 16" housing accommodates mogul base 175, 250 or 400W MH and 250 or 400W HPS lamps. 22" housing available with mogul base 250 or 400W MH or HPS lamp.

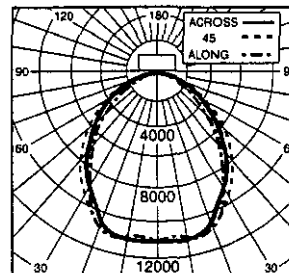

Candlepower distribution curve of 400W MH Canopy Light.

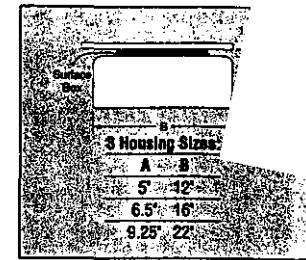

Mountings

For **Direct Mount** the housing is supplied with four 0.188" clearance holes for #8 screws. Four #8 x 1" sheet metal screws and sealing washers are provided for a watertight seal. When surface or feed-thru wiring is required, an SB-16 Surface Box accessory is available. For installation on a combustible surface, a 1" spacer or an SB-16 Surface Box is required for 12" housing-150W HPS or 175W MH fixtures and 16" housing-400W fixtures. The **Quick Mount** option is also available (described on page 114).

Wiring

Two 1/2" flush, threaded openings with socket drive closure plugs are provided for one or two 1/2" conduits. 150°C minimum supply wire is required.

Labels

Direct Mount: UL Listed in the U.S. and Canada for wet locations. Enclosure classified IP54 (22") and IP65 (12" & 16") per IEC 529 and IEC 598. Not UL Listed for feed-thru wiring unless SB-16 Surface Box accessory is used.

Quick Mount: UL Listed for damp locations.

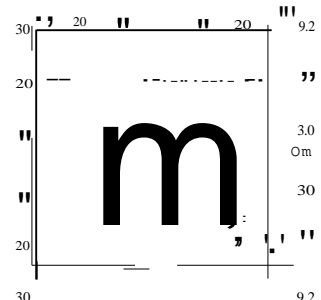

Isotroptic plot of one 400W MH Canopy Light at 15' mounting height.

Catalog Number LogicVoltage SuHlx Key
Accessories

...Page 101
...Page 115
...Pages 152-155

Canopy Light

10:37:00

Square Series

Housings

Ruud SE Series Square Lights are designed with an aluminum die cast ballast housing. For added durability, the housing is supplied with our great DeltaGuard finish, which features an E-coat epoxy primer and bronze acrylic powder topcoat.

Reflector Systems

By varying internal shrouds and reflectors, five optical systems are available to meet a wide range of applications. A virtually unbreakable polycarbonate lens is UV-stabilized to minimize yellowing problems common with most fixtures of this type.

Lamps

A medium base HID lamp is included with each fixture. HID fixtures range from 35-175 watts. Some models are also available in fluorescent, and include a 26W quad tube compact fluorescent lamp.

Ballasts

Inside the housing, the ballast and electrical components are strategically located to reduce operating temperatures and extend component life. The 8" sq. fixtures are standard with a normal power factor ballast; 12" sq. fixtures use a high power factor ballast.

Compact Size

Two sizes are available: 8" sq. x 7.2" deep and 12" sq. x 8.1" deep.

Wiring

150°C supply wire is required on HID fixtures.

Installation

Both sizes of the SE Series are designed for quick and easy installation. Multiple knockouts are provided for mounting over 4" square or octagonal and single gang J-boxes, and for 1/2" conduit entry from the sides and rear.

Labels

All square lights are UL Listed in the U.S. and Canada for wet locations, and enclosure classified IP54 per IEC 529 and IEC 598.

Aluminum die cast housing with DeltaGuard finish, featuring E-coat epoxy primer and bronze acrylic powder topcoat

Reflector provides precise light control

4kv rated porcelain lamp socket and medium base MH or HPS lamp supplied with each fixture; 26W quad tube compact fluorescent lamp supplied with fluorescent fixtures

Injection molded polycarbonate lens

SE3 Typical Cutaway

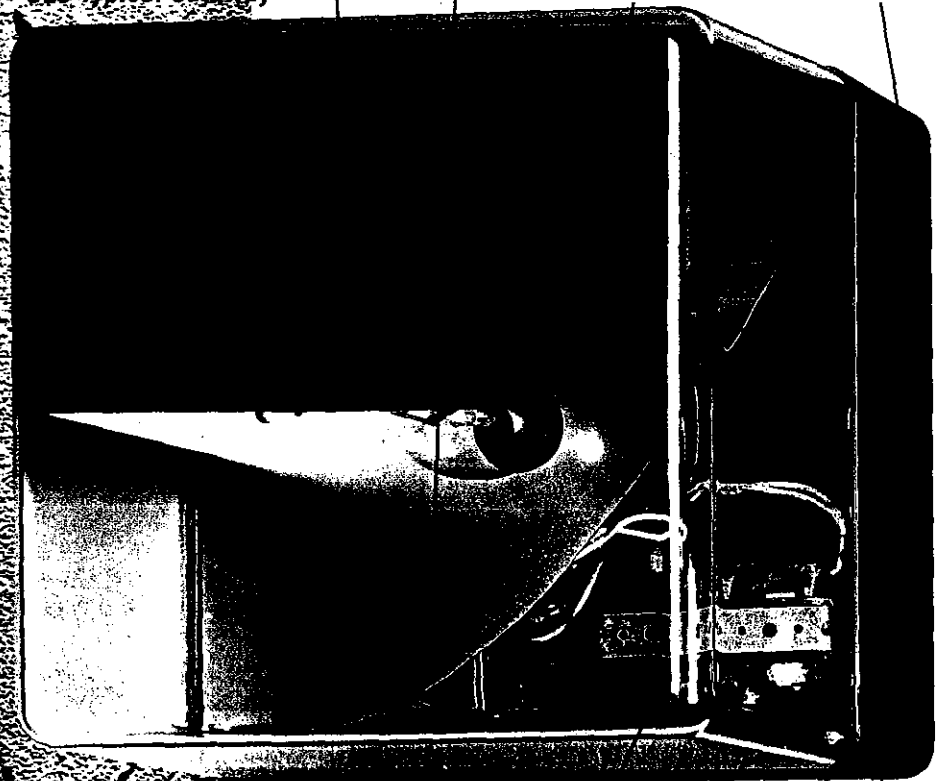

Close cell EPDM/neoprene sponge gasket (silicone for 12") at back of housing ensures a watertight seal

Silicone sponge cord gasket between housing and lens ensures a water- and insect-tight seal

Ballast and other electrical components are strategically located and heat sunk to the housing to increase life

Multiple knockouts are provided for mounting over 4" square or octagonal and single gang J-boxes, and for 1/2" conduit entry from the sides and rear

Square HID/Fluorescent (Wall Mount) SE Series

Lamp Included!

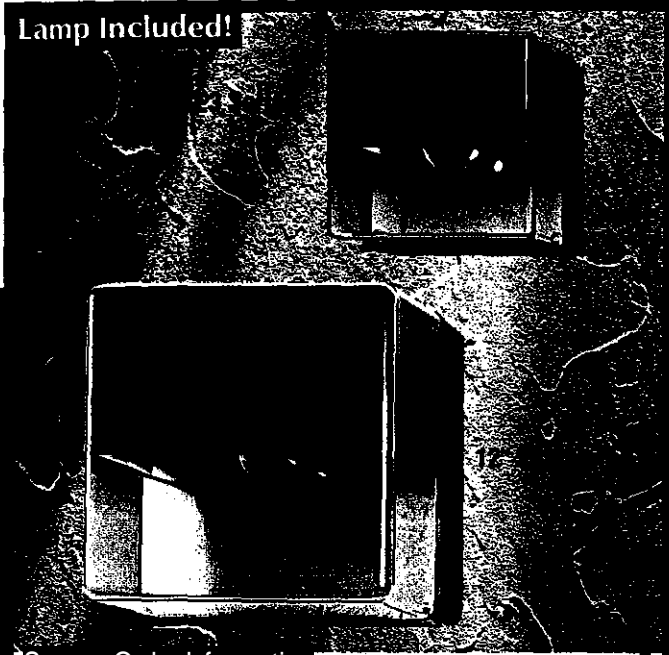

SE3 Series Perimeter Cutoff
 The reflector directs light downward to wash the wall below and to the sides of the fixture. The extra wide cutoff distribution provides glare control and permits maximum spacing between fixtures (recommended spacing is 4 times mounting height).

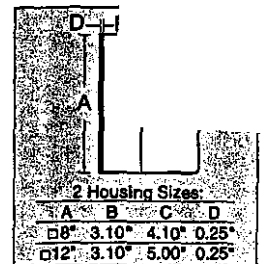

Square Order Information

Housing Size (sq.)	Wattage/Lamp Type	Catalog Number	Mounting Position
12'	26W Fluorescent	SE3226-1	Any
12'	26W Fluorescent	SE3226-2	Any
8'	50W MH	SE3405-0	Wall Downlight
8'	70W MH	SE3407-D	Wall Downlight
12'	100W MH	SE3410-D	Wall Downlight
12'	175W MH	SE3417-M	Wall Downlight
8'	35W HPS	SE3503-1	Any
8'	50W HPS	SE3505-1	Any
8'	70W HPS	SE3507-1	Wall Downlight
12'	100W HPS	SE3510-M	Wall Downlight
12'	150W HPS	SE3515-M	Wall Downlight

Options: (Factory-installed) Change Add After
 Description SuHix To Suffix

208V ballast (35, 50 & 70W HPS only)		3
240V ballast (35, 50 & 70W HPS only)		
277V ballast (35, 50 & 70W HPS only)		
Tri-volt ballast (70 & 100W MH only)		
Canada only		
Tri-volt ballast (175W MH, 100W-150W HPS only)		T
Canada only		
Single Fuse* (120V, 277V or 347V)	1, 2 Of 6	F
Dual Fuse* (208V or 240V)	3 or 4	
Photocell* (120V, 277V, 208V, 240V or 347V)	1, 2, 3, 4 or 6	p

High Power Factor ballast H
 NOTE: For 8' fixtures only except SOW MH & S0-70W HPS with 347V
 Tamperproof Lens Fasteners
 Quartz Standby (non delay-relay type) (includes 10DW Q lamp) Q
 NOTE: Quartz and Fuse options are not available together, in 8' square housing
 *Fixtures with factory-installed photocell and/or fuses supplied with single voltage ballast.

Accessory: (Page 31)

Description	Catalog Number
Tamperproof Screwdriver	TPS-1

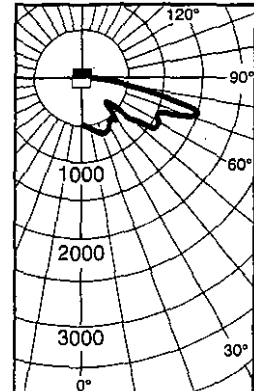

Candlepower Distribution Curve of SOWHPS 8' Perimeter Cutoff light.

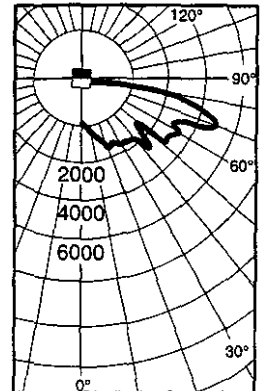

Candlepower Distribution Curve of 175W MH 12' Perimeter Cutoff Light.

t:I=i:c:J=n;:::;:n

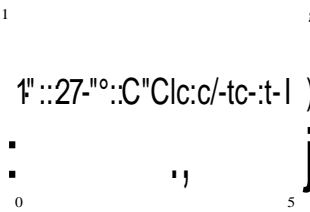

Isofootcandle plot of one SOW HPS 8' Perimeter Cutoff light at 10' mounting height (plan view).

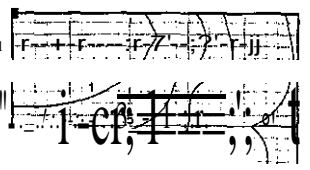

Isofootcandle plot of one 175W MH 12' Perimeter Cutoff Light at 15' mounting height (plan view).

Mounting Multipliers

Height (ft.)	Multiplier
7'	2.04
8'	1.56
9'	1.23
10'	1.00
12'	0.69
15'	0.44
20'	0.25

Mounting Multipliers

Height! (ft.)	Multipller
8'	3.52
10'	2.25
12'	1.56
15'	1.00
20'	0.56
25'	0.36

The 8' SE3 Series photometric data was developed in testing Ruud fixtures with clear, SOW HPS 4,000 lumen medium base lamps. Footcandle readings for other wattages and lamp types may be obtained by multiplying the chart values by the following:

Wattages	Multiplier
50W MH	0.85
70W MH	1.38
35W HPS	0.56
70W HPS	1.63

The 12' SE3 Series photometric data was developed in testing Ruud fixtures with clear, 175W MH 14,000 lumen medium base lamps. Footcandle readings for other wattages and lamp types may be obtained by multiplying the chart values by the following:

amp/Wattages	Multipller
26W Fluor.	0.13
100W MH	0.64
1DOW HPS	0.68
150W HPS	1.14

Catalog Number Logic/Voltage Suffix Key Page 5
 Accessories Page 31

Street & Walkway Lighting

Walkway --f 10' Pole, w/ 175w
 Street (+) c'.o' fo{k'. w / 400w

DAUPHIN ASSOCIATES, INC.

PRODUCT & APPLICATION SALES GROUP

DATE:

TO:

JOB: Messiah College - Site Lighting

YOUR P.O. #:

	MEB	DESCRIPTION	ITEM
A175	LITHONIA	KSF1-175M-R2- ON SSS-12-4C	-SP04-DDB-SF-VG M19-DDB POLE
8400	LITHONIA	KSF2-400M-R2-	-SP04-DDB-SF-VG
C400	LITHONIA	(2) KSF2-400M-R2 ON SSS-20-SC	-SP04-DDB-SF-VG M19-DDB POLE
0175	LITHONIA	KSF1-175M-R2 ON SSS-10-4C	SP04-DDB-SF-VG M19-DDB POLE
E175	LITHONIA	KSF1-175M-R4 ON SSS-10-4	-SP04-DDB-SF-VG M19-DDB POLE
F175	LITHONIA	KSF1-175M-R ON SSS-12-4	-SP04-DDB-SF-VG DM19-DDB POLE

TB

Catalog Number

KSF1 175M-R2-277-SP04-DDB-SF VG

Type

A175

FEATURES

HOUSING - Rugged, .063" thick, lightweight aluminum rectangular housing. All seams are continuously welded for weather-tight seal and integrity. Standard finish is dark bronze (DOB) polyester powder finish. Other powder architectural colors available.

DOOR FRAME - Naturally anodized, extruded, aluminum door frame with mitered corners is retained with (two) .188" diameter hinge pins and secured with (one) quarter-turn, quick release fastener. Weather-proof seal between housing and door frame is accomplished with an integrally designed, extruded silicone gasket that snaps into door frame.

LENS - .125" thick, impact-resistant; tempered glass with thermally-applied, silk screened power door shield.

MOUNTING - Extruded, 4" aluminum, arm for pole or wall mounting. Shipped in fixture carton. Optional mountings available.

OPTICS - Reflectors are anodized and segmented for superior uniformity and control, which allows the flexibility to mix distributions without compromising the overall lighting job. Reflectors attach with toolless fasteners and are rotatable and interchangeable. Three cutoff distributions available: Type II (Roadway), Type III (Asymmetric), Type IV (Forward Throw).

ELECTRICAL SYSTEM - Constant-wattage autotransformer ballast. Ballast is copper wound and 100% factory tested. Removable power door and positive locking disconnect plug.

SOCKET - Porcelain, horizontally-oriented, mogul-base socket with copper alloy, nickel-plated screw shell and center contact. UL listed 1500W-600V.

LISTING - UL 1572 listed for wet locations. Listed and labeled to comply with Canadian standards (see options).

Arm-Mounted Rectilinear Cutoff Lighting

MONARCH

KSF1 175M

175W METAL HALIDE

12' to 20' Mounting

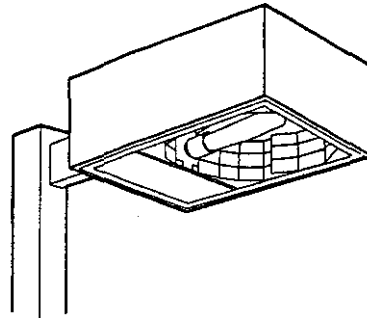

Standard Dimensions

EPA: 1.5 ft.² (14m²) (includes arm)
 Length: 22 1/2" (569)
 Width: 16-3/16" (411.11)
 Depth: 7-1/4" (184.1)
 Weight: 39 lbs (17.7kg)
 Arm: 4110.21

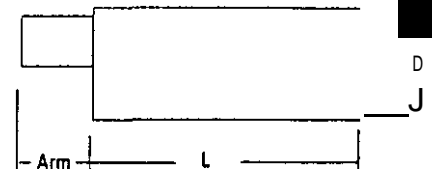

All dimensions are in inches (centimeter) unless otherwise specified.

ORDERING INFORMATION

Choose the boldface catalog nomenclature that best suits your needs and write it on the appropriate line. Order accessories as separate catalog number(s).

Example: **KSF1175M R3 120 SP04SF DOB DDB-SF-VG**

Series	Mounting	Options
KSF1 175M	120	Shipped installed in Rxture
R2 IES Type II Roadway	20t	SF Single fuse 1120, 277, 347V, n/a TB)
R3 IES Type III Asymmetric	240¹	OF Double fuse (208, 240, 480V, n/e TB)
R4 IES Type IV Forward Throw	347	PER NEMA twist-lock receptacle only (no photocontrol)
	480¹	QP8 Quartz restrike system (75W max) (lamp not included, 120V only)
	TB¹	EC Emergency Circuit
		CR Corrosion-resistant Finish
		CSA Listed and labeled to comply with Canadian standards.
		Shipped separately
		PEI NEMA twist-lock PE (120, 208, 240V)
		PE3 NEMA twist-lock PE B47V
		PE4 NEMA twist-lock PE 480V
		PE7 NEMA twist-lock PE tznVJ
		SC Shorting cap for PER option
		KSFIHS House side shield (R2, R3)
		KSFIVG Vandal guard

NOTES:

- Consult factory for availability in Canada.
- Optional multi-temperature ballast (120, 211B, 240, 277V). (120, 277, 347V in Canada).
- The SP09, RP09 or WW09 must be used when two or more luminaires are oriented on a so-called drilling pattern.
- May be ordered as accessory.
- Additional architectural colors available; please see paint brochure.
- For arm mounting, refer to technical data section in the Monarch binder for drilling template:

MB Mounting bracket

IAARM When ordering KMA, DAIZ

OPTIONAL MOUNTING (shipped separately)

DA12P Degree arm (Pole)
 DA12WB Degree arm (Wall)
 KMA Mast arm adapter
 KTMB Twin mounting bar

SPxx RPIoc, OA12P
 WBN, DA12WB
 WWu

Accessories: Tenon Mounting Slipfitter

Order as separate catalog number.
 Number of fixtures

Tenon 0.0.	One	Two	Three	Four	Five	Six
2-318"	T20-190	T20-280	T20-320	T20-390	T20-490	
2-7/8"	125-190	125-280	125-320	125-390	115-490	
4"	T35-190	135-280	T35-320	T35-390	135-490	

L/THDNA LIGHTING

Catalog Number	Type
SSS-12-4C-DM1 9-DDB	A175

FEATURES

SHAFT - Weldable grade hot-rolled commercial-quality carbon steel tubing with a minimum yield of 55,000 psi (7 gauge), 50,000 psi (11 gauge). Uniform wall thickness of .125" or .188". Shafts are one-piece with a longitudinal electric resistance weld. Uniformly square in cross-section with flat sides, small corner radii and excellent torsion. Available shaft widths are 4", 5" and 6".

ANCHOR BASE - Fabricated from hot-rolled carbon steel plate that meets or exceeds a minimum yield strength of 36,000 psi. The anchor base is provided with slotted holes.

HANDHOLE - A rectangular reinforced handhole rim having nominal dimensions of 3x5" for all shafts. Included is a steel cover with attachment screws.

GROUNDING - A nut holder located immediately inside the handhole rim is provided with a 1/2" - 13 UNC ground bolt and nut.

ANCHOR BOLTS - Top 12" galvanized per ASTM A-153. Made of 3/4" or 1" diameter steel rod having a minimum yield strength of 55,000 psi.

HARDWARE - Fasteners are high-strength galvanized zinc-plated or stainless steel.

TOP CAP - Weatherproof, high-strength plastic cap standard for drill-mount poles.

FINISHES - Dark bronze (DOB) polyester powder finish standard. Other architectural colors available.

BASE COVER - Automot'1ve-grade ABS plastic full-cover finished to match pole.

Anchor Base Poles

SSS

SQUARE STRAIGHT STEEL
10' to 39' Mounting

SSS 4" SHAFT

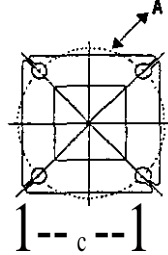

SSS 5" & 6" SHAFT

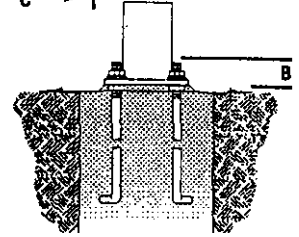
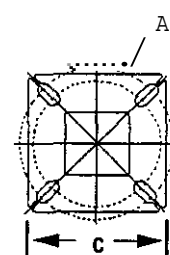

ORDERING INFORMATION

Choose the boldface catalog nomenclature that best suits your needs and write it in the appropriate blank.

Example: SSS3056DM19DOB

SSS	12	4C	DM19	DDB
------------	-----------	-----------	-------------	------------

Shaft type	Nominal mounting height	Nominal shaft base size/wall thickness	Mounting	Options
SSS	ID-39 feet (See back page.)	(See back page.)	Tenon Mounting py1 Open top T20 2-318" 0.0.12" NPSJ T2S 2-718" 0.0.12-112" NPSJ T30 ² 3-112" 0.0.13" NPSJ 135: 4" 0.0. (3-1/2".NPS) Drill Mounting DM19x3 1 at 90° DM28... 2 at 180° DM2hPL ³ 2 at 180° with one side plugged DM29x ³ 2 at 90° DM39x ³ 3 at 90° DM49x' 4 at 90°	Architectural Colors (powder finish) ⁴ Standard Colors DOB Dark bronze DWH White DBL Black Classic Colors DMB Medium bronze DNA Natural aluminum DSS Sandstone DGC Charcoal gray DTG Tennis green DBR Bright red DSB Steel blue

Shaft Base Circle Size	Bolt A	Bolt Projection B	Base Square C	Anchor Bolt Description	Warehouse Anchor Description	Template Bolt Number
4C	B-112	2-3/4"-r	8"	ABSSS-4C	AB18-0	PJ50004
4G	8-112	2-314"-t	8"	ABSSS-4G	AB30-0	PJ50004
5-	10--12	3-3/B"-t	11-	ABSSS-S	AB36-0	PJ50010
S-	11--13	3-318"-t	12-112"	ABSSS-6	AB36-0	PJ50011

- NOTES:
 1 KKS series luminaires w/1 fit 4" square poles only.
 2 3.112" and 4" Tenons available on 5" and G" shafts only.
 3 The drilling template to be used for a panelular luminaire depends on the luminaire that is used.

Rep!q1 *r(w/h	Drilling Template Reference Number	Drilling for Luminaire Serial ORCG1, ORDG1 KRES1 KRE1, KRES2, KSES1, ORCG2, ORDG2 KRE2, KSES2, ORC1, ORC2, ORD1, ORD2
1	1	ORCG1, ORDG1
2	2	KRES1
3	3	KRE1, KRES2, KSES1, ORCG2, ORDG2
4	4	KRE2, KSES2, ORC1, ORC2, ORD1, ORD2
Blank	5	All other Lithonia Area Luminaires

Refer to the Technical Data Section of the Monarch Binder for Drilling Templates.
 4 Additional architectural color available; see paint brochure.

!PDRTAHT:

- Do not treat poles without fixtures in place.
- Factory-supplied template must be used when setting anchor bolts. Lithonia will not accept claim for incorrect anchorage placement due to failure to use factory template.
- If pole is stored outside, protective wrapping paper and cardboard must be removed immediately to prevent finish damage.



SPECIFICATION OUTDOOR LIGHTING

135-POLE

SSS Square Straight Steel Poles

TECHNICAL INFORMATION													
Catalog Number	Nominal mounting height (feet)	Pole Size (in. x in. x ft)	Wall Thickness (inches)	Gauge	EPA (ft) with 1.3 gust						Bolt Circle (inches)	Bolt Size (in. x in. x in.)	Approximate ship weight (pounds)
					80 mph	Max. weight	90 mph	Max. weight	100 mph	Max. weight			
SSS 104C	10	4.0x 10.0	0.125	11	30.6	765	23.8	595	18.9	473	8-9	3/4x 18x3	75
SSS 124C	12	4.0x 12.0	0.125	11	24.4	610	18.8	470	14.8	370	8-9	3/4x 18x3	90
SSS 144C	14	4.0x 14.0	0.125	11	19.9	458	15.1	378	11.7	293	8-9	3/4x 18x3	100
SSS 164C	16	4.0x 16.0	0.125	11	15.9	398	11.8	295	8.9	223	8-9	3/4x 18x3	115
SSS 184C	18	4.0x 18.0	0.125	11	12.6	315	9.2	230	6.7	168	Ø	3/4x 18x3	125
SSS 204C	20	4.0x 20.0	0.125	11	9.6	240	6.7	167	4.5	150	8-9	3/4x 18x3	140
SSS 204G	20	4.0x 20.0	0.188	7	16.5	415	12.2	310	9.3	240	8-9	3/4x 30x3	198
SSS 20SC	20	5.0x 20.0	0.125	11	17.7	443	12.7	343	9.4	215	10-12	1x 36x4	185
SSS 205G	20	5.0x 20.0	0.188	7	28.1	703	21.4	535	16.2	415	10-12	1x 36x4	265
SSS 2S4C	25	4.0x 2S.0	0.125	11	4.8	150	2.6	100	1.0	50	8-9	3/4x 18x3	170
SSS 2S4G	25	4.0x 2S.0	0.188	7	10.8	270	7.7	188	5.4	135	Ø	3/4x 30x3	245
SSS 2SSC	25	5.0x 2S.0	0.125	11	9.8	245	6.3	157	3.7	150	10-12	1x 36x4	225
SSS 2SSG	25	5.0x 2S.0	0.188	7	19.3	480	14.0	350	10.0	250	10-12	1x 36x4	225
SSS 30SC	30	5.0x 30.0	0.125	11	4.7	150	2.0	50	--	--	10-12	1x 36x4	245
SSS 305G	30	5.0x 30.0	0.188	7	10.7	270	6.7	167	3.9	100	10-12	1x 36x4	380
SSS 306G	30	6.0x 30.0	0.188	7	15.7	392	10.2	257	6.4	110	1H3	1x 36x4	520
SSS 3SSG	35	5.0x 3S.0	0.188	7	5.9	150	2.5	100	--	--	10-12	1x 36x4	440
SSS 3S6G	35	6.0x 3S.0	0.188	7	9.5	237	5.0	150	1.8	50	1H3	1x 36x4	540
SSS 396G	39	6.0x 39.0	0.188	7	5.1	128	1.3	33	--	--	1H3	1x 36x4	605

BASE DETAIL SSS 4" SHAFT

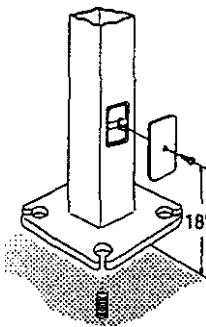

BASE DETAIL SSS 5" & 6" SHAFT

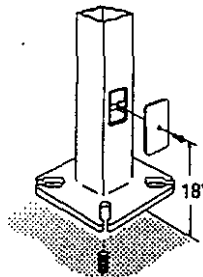

POLE OPTIONS

SUFFIX DESCRIPTION

FOL U	Festoon Outlet - less electrical
FGL U	Festoon GFI Outlet - less electrical
HI - 18S	Horizontal Arm Bracket - I fixture
VO	Vibration Damper (5" and 6" poles only)
I/AB	Less Anchor Bolts
HH	Extra Handhole

NOTES:

- 1 Specify location orientation when ordering (specify orientation from handhole).
- 2 Consult factory for more detail concerning festoon outlet.
- 3 Combination of Tenon-top end drill mount requires extra handhole.

IMPORTANT:

These specifications are intended for Lithonia Lighting products only. Lithonia Lighting is in a continuing effort to upgrade its products. Installation requires grout to be picked under base to ensure full contact with foundation.

135-POLE

C1994 Lithonia Lighting, Rev. 10/97
135-Pole.PMS

LITHONIA LIGHTING

SPECIFICATION OUTDOOR LIGHTING

1815 EAST ELMORE ST., CAAWFOODSVILLE, INDIANA 41133, TELEPHONE 786-182-1137, FAX 715382-8083
IN CANADA: 1100 50th AVE., LACHINE, QUEBEC H1T 2V3, A UNIT OF N.S.I. HOLDINGS, INC.

FEATURES

HOUSING - Rugged, .063" thick, lightweight aluminum rectangular housing. All seams are continuously welded for weathertight seal and integrity. Standard finish is dark bronze IODBI polyester powder. Other powder architectural colors available.

DOOR FRAME - Naturally anodized, extruded aluminum door frame with mitered corners is retained with (two) .188" diameter hinge pins and secured with one quarter-turn, quick-release fastener. Weatherproof seal between housing and door frame is accomplished with an integrally-designed, extruded silicone gasket that snaps into doorframe.

LENS -.125" thick, impact-resistant tempered glass with thermally-applied, silk screened power door shield.

MOUNTING - Extruded 4" aluminum arm for pole or wall mounting shipped in fixture carton. Optional mountings available.

OPTICS - Reflectors are anodized and segmented for superior uniformity and control, which allows the flexibility to mix distributions without compromising the overall lighting job. Reflectors attach with tool-less fasteners and are rotatable and interchangeable. Four cutoff distributions available: Type II (Roadway), Type III (Asymmetric), Type IV (Forward Throw), Type V (Square Symmetrical).

ELECTRICAL SYSTEM - Constant-wattage autotransformer is 100% copper wound and factory tested. Removable power door and positive locking disconnect plug.

SOCKET - Porcelain, horizontally-oriented, mogul-base socket with copper alloy, nickel plated screw shell and center contact UL listed 1500W-600V.

LISTING - UL 1572 listed for wet locations. Listed and labeled to comply with Canadian Standards (see options).

Arm-Mounted Rectilinear Cutoff Lighting

MONARCH

KSF2 400M

400W METAL HALIDE
15' to 25' Mounting

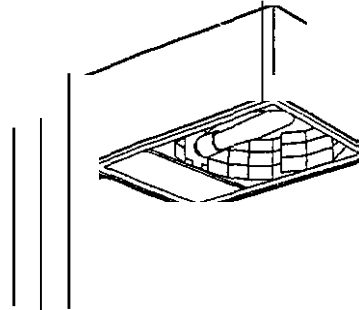

Standard dimensions
EPA: 2.0 ft.² f.28m² (includes arm)
Length: 25.5"/t& 164.3"
Width: 18-1/2" (47.01)
Depth: 8/16" (21.11)
Weight 52lbs (23.&kg)
Ann: 4 (10.21)

All dimensions are finished (centimeter unless otherwise specified).

ORDERING INFORMATION

Choose the boldface catalog nomenclature that best suits your needs and write it on the appropriate line. Order accessories as separate catalog number.

Example: **KSF2400MR3120SP04SFDOB**

KSF2-400M	R2	1/1 : SP04	
Series	Voltage	Mounting	
KSF2 400M ¹	120 2082	SP04 Square pole (4" arm) {standard}	
Distribution			
RZ IES Type II Roadway	2402	SPOS Square pole (9" arm)	
R3 IES Type III Asymmetric	277	RP04 Round pole (4. arm)	
R4 IES Type IV Forward Throw	347	RP09 Round pole (9" arm)	
R5 IES Type V Square	4802	WW04 Wood pole or wall (4" arm)	
		WN09 Wood pole or wall (9" arm)	
		WB04 Wall bracket (4" arm)	
		WB08 Wall bracket (9" arm)	
		MB Mounting bracket	
		UARM When ordering KMA, DA12	

NOTES:

- Use ED28 reduced jacketed lamp. Consult factory for availability in Canada. Option II multi-tap ballast (120, 208, 240, 277, 347V in Canada).
- SP09, RP09 or WW09 must be used when two or more luminaires are oriented on 190° drilling pattern.
- Mounting options available; see separate brochure.
- Additional architectural colors available; see point brochure.
- For arm mounting, refer to technical detail section in Monarch binder for drilling template:
Mounting Options **Drilling template**
SPxx, RPxx, OA12P
WBxx, DA12WB
WWxx

DDB-SF-VG	Options
	Architectural Colors (powder finish) Standard Colors

- Shipped Installed In Fixture
- SF Single fuse (120, 277, 347V, 480V)
- OF Double fuse (208, 240, 480V, 575V)
- PER NEMA twist-lock receptacle only (no photocontrol)
- QRS Quartz restrick system (75W max) (lamp not included. 120V only)
- EC Emergency Circuit
- CR Corrosion-resistant Finish
- CSA Listed and labeled to comply with Canadian Standards.
- Shipped in separate box
- PEI NEMA twist-lock PE (120, 208, 240V)
- PE3 NEMA twist-lock PE (347V)
- PEI NEMA twist-lock PE (480V)
- PE7 NEMA twist-lock PE (277V)
- SC Shorting cap for PER option KSF211S House side shield IR2.R3)
- KSF2VG Vandal guard
- DDS Dark bronze (standard)
- DWH White
- DBL Black
- Classic Colors
- OMS Medium bronze
- DNA Natural aluminum
- DSS Sandstone
- DGC Charcoal gray
- DTG Tennis green
- DBR Bright red
- DSB Steel blue

Accessories: Tenon Mounting S/ ipfitt Br

Order separate catalog number, Number of fixture

Tenon	0.0	One	Two	Ct80	Two	090	2	Three	C120	Three	090	2	Four	090	2
2-W	120-1111	120-280	120-280	120-280	120-320	120-31111									
2-7N	125-190	125-280	125-280	125-280	125-320	125-31111									
4	135-1111	135-280	135-280	135-280	135-320										

KSF2 400M Arm-Mounted Rectilinear Cutoff Lighting

→ Coefficient of Utilization —
 . Initial footcandles —

KSF2 R2 ED-28 Test no. 1193031801

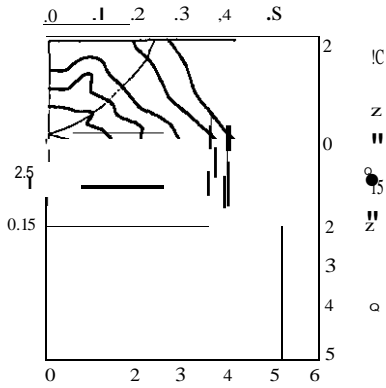

400W Metal Halide lamp, 32,000 rated lumen.
 Footcandle values based on 30' mounting height, Distribution Type II, cutoff.

KSF2 R3 ED-28 Test no. 1194100501

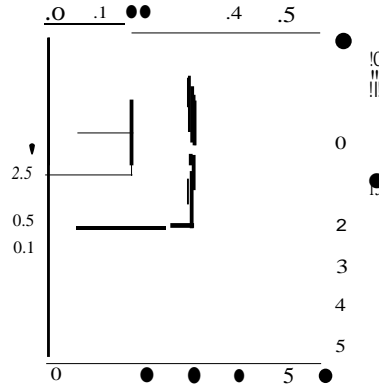

400W Metal Halide lamp, 32,000 rated lumen.
 Footcandle values based on 30' mounting height, Distribution Type III, cutoff.

KSF2 R4 ED-28 Test no. 1193041301

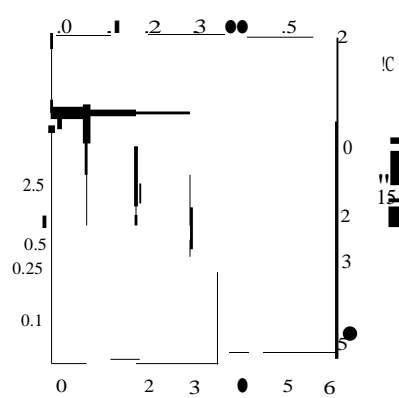

400W Metal Halide lamp, 32,000 rated lumen.
 Footcandle values based on 30' mounting height, Distribution Type IV, cutoff.

KSF2 R5S ED-28 Test no. 1193051801

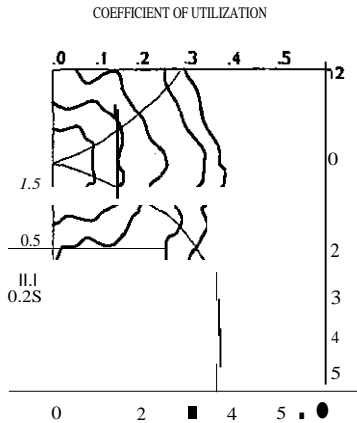

400W Metal Halide lamp, 32,000 rated lumen.
 Footcandle values based on 30' mounting height, Distribution Type V, cutoff.

NOTES:

- For electrical characteristics, consult technical data tab.
- Tuned to current IES and NEMA standards under stabilized laboratory conditions. Various operating factors can cause differences between laboratory and actual field measurements. Dimensions and applications are based on the most current available data and are subject to change.

Mounting Height Correction Factor

Multiply the fc level by the correction factor!

- 25 ft • 1.44
- 32 ft • .88
- 35 ft • .73

$$\frac{\text{Existing Mounting Height}^2}{\text{New Mounting Height}^2} = \text{Correction Factor}$$

FEATURES

- SHAFT** — Weldable grade hot-rolled commercial-quality carbon steel tubing with a minimum yield of 55,000 psi (17 gauge), 50,000 psi (11 gauge). Uniform wall thickness of .125" or .188". Shafts are one-piece with a longitudinal electric resistance weld. Uniformly square in cross-section with flat sides, small corner radii and excellent torsion. Available shaft widths are 4', 5' and 6".
- ANCHOR BASE** — Fabricated from hot-rolled carbon steel plate that meets or exceeds a minimum yield strength of 36,000 psi. The anchor base is provided with slotted holes.
- HANO HOLE** — A rectangular reinforced handhole rim having nominal dimensions of 3x5' for all shafts. Included is a steel cover with attachment screws.
- GROUNDING** — A nut holder located immediately inside the handhole rim is provided with a 1/2" - 13UNC ground bolt and nut.
- ANCHOR BOLTS** — Top 12" galvanized per ASTM A-153. Made of 3/4" or 1" diameter steel rod having a minimum yield strength of 55,000 psi.
- HARDWARE** — Fasteners are high-strength galvanized zinc-plated or stainless steel.
- TOP CAP** — Weatherproof, high-strength plastic cap standard for drill-mount poles.
- FINISHES** - Dark bronze (DOB) polyester powder finish standard. Other architectural colors available.
- BASE COVER** - Automotive-grade ABS plastic full-cover finished to match pole.

Catalog Number	Type
SSS-20-5C-DM19-DDB	8400

Anchor Base Poles

SSS

SQUARE STRAIGHT STEEL
10' to 39' Mounting

SSS 4' SHAFT

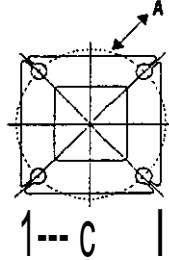

SSS 5' & 6' SHAFT

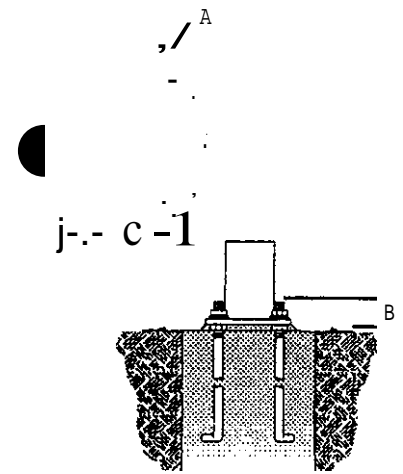

ORDERING INFORMATION

Example: SSS 305G DM19 DOB

Choose the boldface catalog nomenclature that best suits your needs and write it in the appropriate blank.

SSS	20	SC	DM19	DOB
Shaft type SSS	Nominal mounting height 10-39 feet (See back page.)	Nominal shaft base size/ wall thickness See back page.)	Mounting Tenon Mounting py1 Open top T20 2-3/8-0.0. (2" NPSI) T25 2-7/8" 0.0. (2-1/TNPS) T30 3-1/2' 0.0. (3" NPSI) y352 4" 0.0.13-1/2" NPSI Drill Mounting DM19r 1 at 90" DM2Br 2 at 90" DM28xPL ³ 2 at 180° with one side plugged DM2Sx ¹ 2 at 90" DM39x ¹ 3 at 90" DM49x ³ 4 at 90"	Options Architectural Colors powder finish ⁴ Standard Colors DDB Dark bronze DWH White DBL Black Classic Colors DMB Medium bronze DNA Natural aluminum DSS Sandstone DGC Charcoal gray DTG Tennis green DBR Bright red DSB Steel blue

Shaft Base Size	Bolt Circle A	Bolt Projection B	Base Square C	Anchor Bolt Description	Warehouse Anchor Description	Template Bolt Number
4'C	8-1/2'	2-3/4"-4"	8'	ABSSS-4C	AB1B-0	PJ50004
4'G	8-11/2"	2-3/4"-4'	B'	ABSSS-4G	AB30-0	PJ50004
5'	10--12'	3-3/B"-4"	11'	ABSSS-5	AB36-0	PJ50010
6'	11"-13'	3-3/B"-4'	12-1/2"	ABSSS-6	AB36-0	PJ50011

NOTES:

- 1 ICKS series luminaires will fit 4" square poles only.
- 2 3-11/2" and 4" Tenons available on 5" and 6" shafts only.
- 3 The drilling template to be used for a particular luminaire depends on the luminaire that is used.

Reg. Code	Drilling Template @ feature Number	Drilling for Luminaires Series
1		ORCG1, ORDG1
2		KRES1
3		KRE1, KRES2, KSES1, ORCG2, ORDG2
4		KRE2, KSES2, ORC1, ORC2, ORD1, ORD2
Blank		All other Lithonia Area luminaire

Refer to the Technical Data Section of the Mounting Binder for Drilling Templates.
4 Additional architectural colors available; see paint brochure.

IMPORTANT

- Do not erect poles without fixtures in place.
- Factory-lupped templates must be used when sitting anchor bolts. Lithonia will not accept claim for incorrect anchorage placement due to failure to use factory template.
- If pole is erected outside, protective wrapping paper and cardboard must be removed immediately to prevent finish damage.

LITHONIA LIGHTING

SPECIFICATION OUTDOOR LIGHTING

135-POLE

SSS Square Straight Steel Poles

TECHNICAL INFORMATION													
Catalog Number	Nominal mounting height (feet)	Pole Shaft size (in x in x ft)	Wall Thickness (inches)	Gauge	EPA (ft) with 1.3 gust						Bolt Circle (inches)	Bolt Size (in. x in. x in.)	Approximate ship weight (pounds)
					BO moh	Max. weight	90 moh	Max. weight	100 moh	Max. weight			
SSS 104C	10	4.0 x 10.0	0.125	11	30.6	765	23.8	595	18.9	473	8--9	3/4 x 18 x 3	75
SSS 124C	12	4.0 x 12.0	0.125	11	24.4	610	18.8	470	14.8	370	8--9	3/4 x 18 x 3	00
SSS 144C	14	4.0 x 14.0	0.125	11	19.9	498	15.1	378	11.7	293	8--9	3/4 x 18 x 3	100
SSS 164C	16	4.0 x 16.0	0.125	11	15.9	398	11.8	295	8.9	223	8--9	3/4 x 18 x 3	115
SSS 184C	18	4.0 x 18.0	0.125	11	12.6	315	9.2	230	6.7	168	8--9	3/4 x 18 x 3	125
SSS 204C	20	4.0 x 20.0	0.125	11	9.6	240	6.7	167	4.5	150	8--9	3/4 x 18 x 3	140
SSS 204G	20	4.0 x 20.0	0.188	7	16.5	415	12.2	310	9.3	240	8-9	3/4 x 30 x 3	198
SSS 205C	20	5.0 x 20.0	0.125	11	17.7	443	12.7	343	9.4	215	10--12	1 x 36 x 4	185
SSS 205G	20	5.0 x 20.0	0.188	7	28.1	711	21.4	535	16.2	405	10--12	1 x 36 x 4	265
SSS 254C	25	4.0 x 25.0	0.125	11	4.8	150	2.6	100	1.0	111	8--9	3/4 x 18 x 3	170
SSS 254G	25	4.0 x 25.0	0.188	7	10.8	270	7.7	188	5.4	135	8--9	3/4 x 30 x 3	245
SSS 255C	25	5.0 x 25.0	0.125	11	9.8	245	6.3	157	3.7	150	10--12	1 x 36 x 4	225
SSS 255G	25	5.0 x 25.0	0.188	7	19.3	400	14.0	350	10.0	211	10--12	1 x 36 x 4	225
SSS 305C	30	5.0 x 30.0	0.125	11	4.7	150	2.0	50	--	--	10--12	1 x 36 x 4	265
SSS 305G	30	5.0 x 30.0	0.188	7	10.7	161	6.7	167	3.9	100	10-12	1 x 36 x 4	310
SSS 306G	30	6.0 x 30.0	0.188	7	15.7	392	10.2	257	6.4	160	11--13	1 x 36 x 4	520
SSS 355G	35	5.0 x 35.0	0.188	7	5.9	150	2.5	100	--	--	10--12	1 x 36 x 4	440
SSS 356G	35	6.0 x 35.0	0.188	7	9.5	237	5.0	150	1.8	111	11--13	1 x 36 x 4	540
SSS 396G	39	6.0 x 39.0	0.188	7	5.1	128	1.3	33	--	--	11--13	1 x 36 x 4	605

BASE DETAIL SSS 4" SHAFT

BASE DETAIL SSS 5" & 6" SHAFT

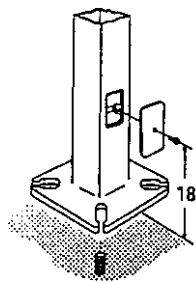
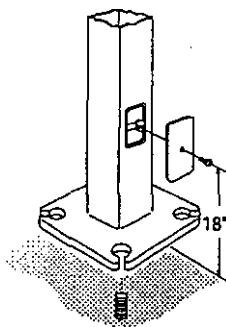

POLE OPTIONS

SUFFIX	DESCRIPTION
FDL1,2	Festoon Outlet - less electrical
FGLU	Festoon GFI Outlet - less electrical
H1-18S'	Horizontal Arm S racket - 1 fixture
VD	Vibration Damper 15" and 6" poles only)
I/AB	Less Anchor Bolts
HH'	Extra Handhole

NOTES:

- Specify location orientation when ordering (Specify orientation from handhole).
- Consult factory for more detail concerning festoon outlets.
- Combination of Tenon-top and drill mount requires extra hand hole.

IMPORTANT:

These specifications are intended for general purpose only. Lithonia Lighting reserves the right to change material or design, without prior notice, in continuing effort to upgrade its products.
 In addition, grout to be picked under the base of the pole to ensure full contact with foundation.

135-POLE

01994 Lithonia lighting, Rev. 10/97
 135-POLE.PMS



SPECIFICATION OUTDOOR LIGHTING

1015 EAST ELMORE ST., CRAWFORDSVILLE, INDIANA 47133, TELEPHONE 795-382-1137, FAX 708-382-9083
 IN CANADA: 1100 501H AVE., LACHINE, QUEBEC H3T 2V3, A LITHONIA HOLDINGS, INC. ...

Catalog Number

(2) KSF2-400M-R2-277-SP04-0DB-SF-VG

C400

FEATURES

HOUSING -Rugged, .063" thick, lightweight aluminum rectangular housing. All seams are continuously welded for

available.

-Naturally anodized, extruded aluminum door

weathertight seal and integrity. Standard finish is dark bronze (008) polyester powder. Other powder architectural colors

DOOR FRAME

frame with mitered corners is retained with (two) .188" diameter hinge pins and secured with one quarter-turn, quick-release fastener. Weatherproof seal between housing and door frame is accomplished with an integrally-designed, extruded silicone gasket that snaps into door frame.

LENS -.125" thick, impact-resistant tempered glass with thermally-applied, silk screened power door shield.

MOUNTING -Extruded 4" aluminum arm for pole or wall mounting shipped in fixture carton. Optional mountings available.

OPTICS -Reflectors are anodized and segmented for superior uniformity and control, which allows the flexibility to mix distributions without compromising the overall lighting job. Reflectors attach with tool-less fasteners and are rotatable and interchangeable. Four cutoff distributions available: Type II (Roadway), Type III (Asymmetric), Type IV (Forward Throw), Type V (Square Symmetrical).

ELECTRICAL SYSTEM -Constant-wattage autotransformer (is) UL-11'S 100% copper wound and factory tested. Removable power door and positive locking disconnect plug.

SOCKET -Porcelain, horizontally-oriented, mogul-base socket with copper alloy, nickel plated screw shell and center contact. UL listed 1500W-600V.

LISTING -UL 1572 listed for wet locations. Listed and labeled to comply with Canadian Standards (see options).

Arm-Mounted R

O IIK

ect1 near g ting

KSF2 400M

400W METAL HALIDE

15' to 25' Mounting

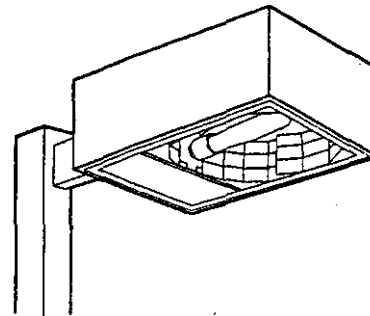

Standard dimensions

EPA: 2.0 ft.² (.28m²) (includes arm)

length: 25 1/2 (64.31)

Width: 18 1/2 (47.01)

Depth: 8.5 (21.6)

Weight: 52 lbs (23.6kg)

Arm: 4 1/2 (11.43)

All dimensions are Inches (centimeters) unless otherwise specified.

ORDERING INFORMATION

Choose the boldface catalog nomenclature that best suits your needs and write down the appropriate line. Order accessories as separate catalog number.

Example: **KSF2 400M R3 120SP04 SF DOB**

KSF2 400M	R2	120V	SP04	Mounting⁷
KSF2 400M ¹		2092	SP04 Square pole (4' arm) (standard) ⁴	
Optical distribution		2402	SP09 Square pole (9' arm)	
R2 IES Type II Roadway		2n	RP04 Round pole (4' arm) ⁴	
R3 IES Type III Asymmetric		7	RP09 Round pole (9' arm)	
R4 IES Type IV Forward Throw		4802	WVOJ. Wood pole or wall (4' arm) ⁵	
R5 IES Type V Square		TB ³	WWO9 Wood pole or wall (9' arm)	
			WB04 Wall bracket (4' arm)	
			WBO1 Wall bracket 18' arm	
			MB Mounting bracket	
			UARM When ordering KMA, DA12	

NOTES:

- Use ED28 reduced jacketed lamp.
- Contact factory for availability in Canada.
- Optional multi-tip ballast (120, 208, 240, 2nV). (120, 277, 347V in Canada).
- SP09, RP09 or WVOJ must be used when two or more luminaires are oriented on a 4" drilling pattern.

May be ordered accessory. Additional architectural colors available; see print brochure.

For arm mounting, refer to technical drawing section in mounting binder for drilling template:

Mounting	Drilling
Shx, RPxx, DA12P	5
WBxx, OA12WB	B
wwa	1

OPTIONAL MOUNTING
(shipped separately)
DA12P Degree arm (Pole)
OA12WB Degree arm (Wall)
KMA Mast arm adapter

ICTMB Twin mounting bar

Accessories: Tenon Mounting Slipfitter

Order in separate catalog number.
Number of fixtures

Tenon 0.0.	One	Two	Three	Four
2-W	T21H90	T20-280	T20-290	T20-3211
2-7K	T25-190	T25-280	T25-290	T25-3211

DDBSF-VG

Options

Shipped Installed In Fixture	Architectural Color (powder finish) Standard Colors
SF Single fuse (120, 277, 347V,	DCB Dark bronze (standard)
n/a TBJ	DWH White
OF Double fuse (208, 240, 480V, n/a TB)	DBL Block
PER NEMA twist-lock receptacle only (no photo control)	Classic Color*
QRS Quartz restrike system (75W max) (lamp not included, 120V only)	DMB Medium bronze
EC Emergency Circuit	DNA Natural aluminum
CR Corrosion-resistant Finish	DSS Sandstone
CSA Listed and labeled to comply with Canadian Standards.	DGC Charcoal gray
Shipped Separately	DTG Tennis green
PEI NEMA twist-lock PE (120, 208, 240V)	DBR Bright red
PE3 NEMA twist-lock PE (347V)	DSB Steel blue
PE4 NEMA twist-lock PE (480V)	
PE7 NEMA twist-lock PE 1277VJ	
SC Shorting cap for PER option	
KSF2HS House side shield IR2,R3J	
KSF2VG Vandal guard	

KSF2400M Arm-Mounted Rectilinear Cutoff Lighting

— Coefficient of Utilization
 — Initial footcandle

KSF2 R2 ED-28 Test no. 1193031801

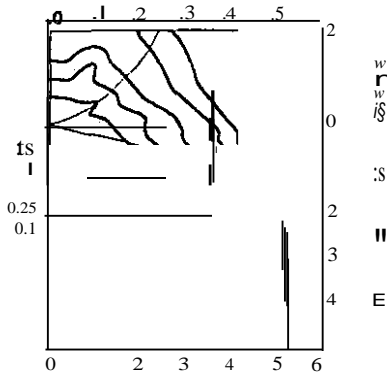

400W Metal Halide lamp, 32,000 rated lumens. Footcandle values based on 30' mounting height. Distribution Type II, cutoff.

KSF2 R3 ED-28 Test no. 1194100501

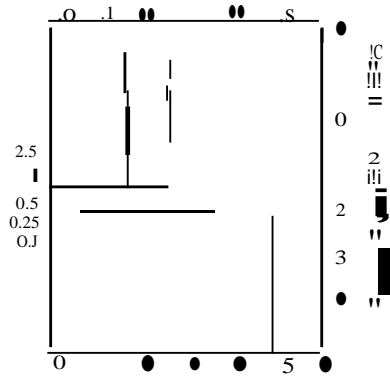

400W Metal Halide lamp, 32,000 rated lumens. Footcandle values based on 30' mounting height. Distribution Type III, cutoff.

KSF2 R4 ED-28 Test no. 1193041301

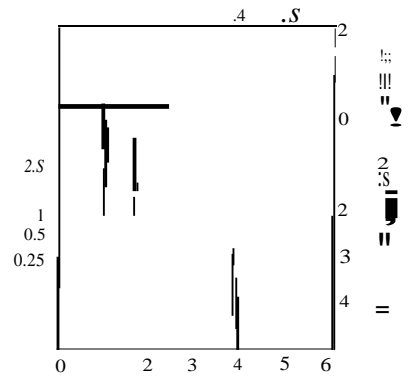

400W Metal Halide lamp, 32,000 rated lumens. Footcandle values based on 30' mounting height. Distribution Type IV, cutoff.

KSF2 R5 SED-28 Test no. 1193051801

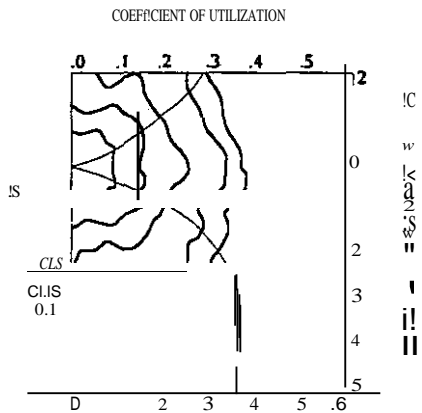

400W Metal Halide lamp, 32,000 rated lumens. Footcandle values based on 30' mounting height. Distribution Type V, cutoff.

NOTES:

- For electrical characteristics, consult technical data tab.
- Tested to current IES and NEMA standards under controlled laboratory conditions. Various operating factors can cause difference between laboratory and actual field measurements. Dimensions and specifications are based on the most current available data and are subject to change.

Mounting Height Correction Factor

(Multiply the level by the correction factor)

25 ft. 1.44

32 ft. .88

35 ft. .73

$$\frac{\text{New Mounting Height}}{\text{Original Mounting Height}} = \text{Correction Factor}$$

715-KSF2

01992 Lhhonla lghdng, Rev. 7197
 715KSF2.PM8

f L/THDNA L/SHING

SPECIFICATION OUTDOOR LIGHTING

101 EAST LAMAR ST., CRAWFORDSVILLE, INDIANA 47813, TEL: 317-411-1137, FAX: 317-411-2408
 101 CANADIAN AVE., LAC-GENE, QUEBEC, CANADA, TEL: 514-381-1137, FAX: 514-381-2408

Catalog Number	SSS-20-5C-DM28-DDB	Type	C400
----------------	--------------------	------	------

FEATURES

- SHAFT** - Weldable grade hot-rolled commercial-quality carbon steel tubing with a minimum yield of 55,000 psi (17 gauge), 50,000 psi (11 gauge). Uniform wall thickness of .125" or .188". Shafts are one-piece with a longitudinal electric resistance weld. Uniformly square in cross-section with flat sides, small corner radii and excellent torsion. Available shaft widths are 4', 5" and 6".
- ANCHOR BASE** - Fabricated from hot-rolled carbon steel plate that meets or exceeds a minimum yield strength of 36,000 psi. The anchor base is provided with slotted holes.
- HANDHOLE** - A rectangular reinforced handhole rim having nominal dimensions of 3x5' for all shafts. Included is a steel cover with attachment screws.
- GROUNDING** - A nut holder located immediately inside the handhole rim is provided with a 1/2" - 13 UNC ground bolt and nut.
- ANCHOR BOLTS** - Top 12" galvanized per ASTM A-153. Made of 3/4" or 1" diameter steel rod having a minimum yield strength of 55,000 psi.
- HARDWARE** - Fasteners are high-strength galvanized zinc-plated or stainless steel.
- TOP CAP** - Weatherproof, high-strength plastic cap standard for drill-mount poles.
- FINISHES** - Dark bronze (DOB) polyester powder finish standard. Other architectural colors available.
- BASE COVER** - Automotive-grade ABS plastic full-cover finished to match pole.

Anchor Base Poles

SSS

SQUARE STRAIGHT STEEL
10'to 39' Mounting

SSS 4' SHAFT



SSS 5" & 6" SHAFT

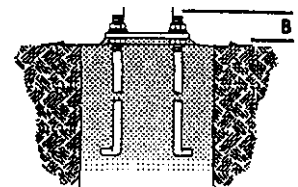
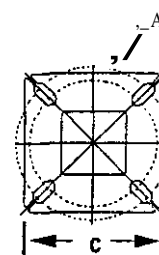

ORDERING INFORMATION

Example: SSS3056DM19DOB

Choose the boldface catalog nomenclature that best suits your needs and write it in the appropriate blank.

SSS	20	SC	DM28	DDB
Shaft type SSS	Nominal mounting height 10-39 feet (See back page.)	Nominal shaft base size/wall thickness (See back page.)	Mounting Tenon Mounting PT1 Open top T21 2-3/8" 0.0. 12" NPS T25 2-7/8" 0.0. 12-1/2" NPS T30 3-1/2" 0.0. (3" NPS) T352 4" 0.0. (3-1/2" NPS) Drill Mounting DM19r3 1 at 90" DM28r1 2 at 180" DM28xPL 2 at 180° with one side plugged DM29x1 2 at 90" DM39x3 3 at 90" DM49x3 4 at 90"	Options Architectural Colors (powder finish) ⁴ Standard Colors DDS Dark bronze DWH White DBL Black Classic Colors DMD Medium bronze DNA Natural aluminum DSS Sandstone DGC Charcoal grey DTG Tennis green DBR Bright red DSB Steel blue

Shaft Base Size	Bol! Circle A	Bol! Projection 8	Base Square C	Anchor Bol! Description	Warehouse Anchor Bolt Description	Template Bolt Number
4C	8-1/2"	2-3/4"-4"	8"	ABSSS-4C	AB18-0	PJ50004
4G	8-1/2"	2-3/4"-4"	8"	ABSSS-4G	AB30-0	PJ50004
5'	10'-12"	3-3/8"-4"	11"	ABSSS-S	AB36-0	PJS0010
6'	11"-13"	3-3/8"-4"	12-1/2"	ABSSS-6	AB36-0	PJS0011

NOTES:

- 1 KKS 1erle1 lumlnalres will fit 4" square polec only.
- 2 3-112" and 4' Tenona available on S* and 6" shaft1 only.
- 3 The drUtting templete to be uted for a particular lumlnalre depends on the lumlnalre that 11used.

Replace "I/ with	Drilling Template Reference Number	Orilling for Lumlnalra S@rlft1
1	1	ORCGt, ORDG1
2	2	KRES1
3	3	KRE1, KRES2, KSES1, ORCG2, ORDG2
4	4	KRE2, KSES2, ORC1, ORC2, ORD1, ORD2
Blank	5	All other Lithonia Area lumlnalrea

Referro the Technical Data Section of the Monarch Binder for Drllllfng Templates.

- 4 Additional arehlattural color* available; *H paint brochure.

IMPORTANT:

- Do 1terectpol1fwithout fixtures in place.
- Factory-supplied templates must be used when setting anchor bolts. Lithonia will not 1ccept claim far 1ncorrect 1nchorag1 pl1c1m1nt due 11feilura 10use factory templete.
- If po1ts 1r1stored outsid1, protective 1llppng peper end cerdboard must be removed immediately to prevent finish d1m1ga.

LITHONIA LIGHTING

SPECIFICATION OUTDOOR LIGHTING

135-POLE

SSS Square Straight Steel Poles

TECHNICAL INFORMATION													
Catalog Number	Nominal mounting height (feet)	Pole Shaft size (in x in x ft)	Wall Thickness (inches)	Gauge	EPA (ft) with 1.3 gust						Bolt Circle (inches)	Bolt Size (in. x in. x in.)	Approximate ship weight (pounds)
					30 mph	Max. weight	90 mph	Max. weight	100 mph	Max. weight			
SSS 104C	10	4.0x 10.0	0.125	11	30.6	765	23.8	595	18.9	473	8--9	3/4x 18x3	75
SSS 124C	12	4.0x 12.0	0.125	11	24.4	610	18.8	470	14.8	370	8--9	3/4x 18x3	90
SSS 144C	14	4.0x 14.0	0.125	11	19.9	498	15.1	378	11.7	293	8--9	3/4x 18x3	100
SSS 164C	16	4.0x 16.0	0.125	11	15.9	398	11.8	295	8.9	223	8--9	3/4x 18x3	115
SSS 184C	18	4.0x 18.0	0.125	11	12.6	315	9.2	231	6.7	168	8--9	3/4x 18x3	125
SSS 204C	20	4.0x 20.0	0.125	11	9.6	240	6.7	167	4.5	150	8--9	3/4x 18x3	140
SSS 204G	20	4.0x 20.0	0.188	7	16.5	415	12.2	310	9.3	240	8--9	3/4x 30x3	198
SSS 20SC	20	5.0x 20.0	0.125	11	17.7	443	12.7	343	9.4	215	10--12	1x 36x4	185
SSS 205G	20	5.0x 20.0	0.188	7	28.1	703	21.4	535	16.2	405	10--12	1x 36x4	265
SSS 254C	25	4.0x 25.0	0.125	11	4.8	150	2.6	100	1.0	75	8--9	3/4x 18x3	170
SSS 254G	25	4.0x 25.0	0.188	7	10.8	270	7.7	188	5.4	135	8--9	3/4x 30x3	245
SSS 25SC	25	5.0x 25.0	0.125	11	9.8	245	6.3	157	3.7	150	10--12	1x 36x4	225
SSS 255G	25	5.0x 25.0	0.188	7	19.3	480	14.0	350	10.0	250	10--12	1x 36x4	225
SSS 30SC	30	5.0x 30.0	0.125	11	4.7	150	2.0	50	--	--	10--12	1x 36x4	265
SSS 305G	30	5.0x 30.0	0.188	7	10.7	270	6.7	167	3.9	100	10--12	1x 36x4	380
SSS 306G	30	6.0x 30.0	0.188	7	15.7	392	10.2	257	6.4	100	11--13	1x 36x4	520
SSS 35SG	35	5.0x 35.0	0.188	7	5.9	150	2.5	100	--	--	10--12	1x 36x4	440
SSS 356G	35	6.0x 35.0	0.188	7	9.5	237	5.0	150	1.8	75	11--13	1x 36x4	540
SSS 396G	39	6.0x 39.0	0.188	7	5.1	128	1.3	33	--	--	11--13	1x 36x4	605

BASE DETAIL SSS 4" SHAFT

BASE DETAIL SSS 5" & 6" SHAFT

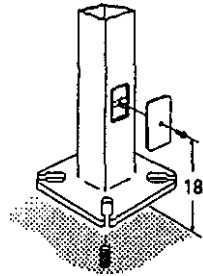
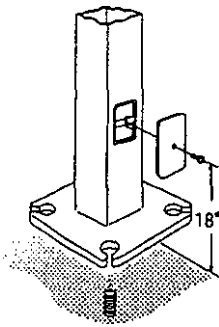

POLE OPTIONS

SUFFIX DESCRIPTION

FOL 11	Festoon Outlet -less electrical
FGL U	Festoon GFI Outlet -less electrical
HHBS '	Horizontal Arm Bracket -1 fixture
VD	Vibration Damper (5" and 6" poles only)
I/AB	less Anchor Bolts
HH'	Extra Handhole

NOTES:

- Specify location orientation when ordering (11 pedestal 11 from handhole).
- Consult factory for more data (11 cone, 11 festoon outlet).
- Combination of Tenon-top and drill mount require (11 handhole).

IMPORTANT:

- These specifications are intended for general use only. Lithonia Lighting reserves the right to change specifications without prior notice, in its continuous effort to improve its products.
- In the event of a discrepancy between these specifications and the product, the product shall prevail.

135-POLE

©1994 Lithonia Lighting, Rev. 10/97
135-POLE.PMB



SPECIFICATION OUTDOOR LIGHTING

1115 EAST ELMORE ST. CRAWFORDSVILLE, INDIANA 47133. TELEPHONE 711B S#2.1837. FAX 716352-1083
CANADA: 1100 IOTHAVE., LACHINE, QUEBEC H1M.1.1. HOLDINGS, NC.

FEATURES

HOUSING -Rugged, .063" thick, lightweight aluminum rectangular housing. AU seams are continuously welded for weather-tight seal and integrity. Standard finish is dark bronze (DOB) polyester powder finish. Other powder architectural colors available.

DOOR FRAME -Naturally anodized, extruded, aluminum door frame with mitered corners is retained with (two) .188" diameter hinge pins and secured with (one) quarter-turn, quick release fastener. Weather-proof seal between housing and door frame is accomplished with an integrally designed, extruded silicone gasket that snaps into door frame.

LENS - .125" thick, impact-resistant tempered glass with thermally-applied, silk screened power door shield.

MOUNTING - Extruded, 4" aluminum, arm for pole or wall mounting. Shipped in fixture carton. Optional mountings available.

OPTICS -Reflectors are anodized and segmented for superior uniformity and control, which allows the flexibility to mix distributions without compromising the overall lighting job. Reflectors attach with toolless fasteners and are rotatable and interchangeable. Three cutoff distributions available: Type II (Roadway), Type III (Asymmetric), Type IV (Forward Throw).

ELECTRICAL SYSTEM -Constant-wattage autotransformer ballast. Ballast is copper wound and 100% factory tested. Removable power door and positive locking disconnect plug.

SOCKET - Porcelain, horizontally-oriented, mogul-base socket with copper alloy, nickel-plated screw shell and center contact. UL listed 1500W-600V.

LISTING -UL 1572 listed for wet locations. listed and labeled to comply with Canadian standards (see options).

Catalog Number

KSF1-175M-R2-277-SP04-DDB-SF-VG

Type

0175

Arm-Mounted Rectilinear Cutoff Light

MONARCH

KSF1 175M

175W METAL HALIDE

12' to 20' Mounting

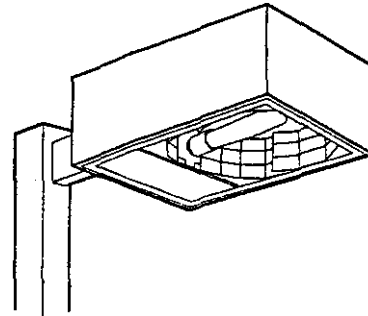

Standard dimensions

EPA: 1.5 ft.l (14ml) (includes arm)
 Length: 22 (55.91)
 Width: 16-3/16 (141.11)
 Depth: 7-1/4 (18.4)
 Weight 39lbs (17.7kg)
 Ann: 4110.2)

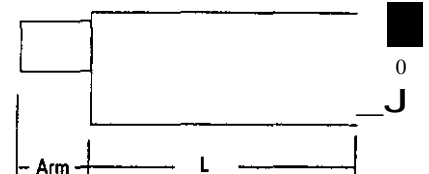

All dimensions are Inches (centimeters) unless otherwise specified.

ORDERING INFORMATION

Choose the boldface catalog nomenclature that best suits your needs and write it on the appropriate Uno. Order

Example: **KSF1175MR3120SP04SFDDB**

Accessories: separate catalog number **T(J SP04**

DDB-SF-VG

	Volts	Mounting	Option	
KSF1 175M	120	SP04 Square pole (4" arm) (standard)	Shipped Installed In Fixture	Architectural Color& (powder finish)5
Distribution	208 ¹ 240 ¹	SPOS Square pole (9" arm)	Sf Single fuse (120, 277, 347V, n/a TB)	Standard Colors DOB Dark bronze (standard)
R2 IES Type II Roadway	m	RP04 Round pole (4" arm) ³	DF Double fuse 1208, 240, 480V, n/a TB)	DWH White
R3 IES Type III Asymmetric	347 490 ¹	RPO4 Round pole (9" arm)	PER NEMA twist-lock receptacle only (no photocontrol)	DBL Black Classic Colors
R4 IES Type IV Forward Throw	TB2	WN04 Wood pole or wall 14" arm	QRS Quartz restrike system (75W max) (lamp not included, 120V only)	DMB Medium bronze
		WB04 Wall bracket (4" arm)	EC Emergency Circuit	DNA Natural aluminum
		WB08 Wall bracket (9" arm)	CR Corrosion-resistant Finish	OSS Sandstone
		MB Mounting bracket	CSA Listed and labeled to comply with Canadian standards.	DGC Charcoal gray
		UARM When ordering KMA, DAT2		DTG Tennis green
		OPTIONAL MOUNTING (shipped separately)		DBR Bright red
		DA12P Degree arm (Pole)	Shipped separately 4	DSB Steel blue
		DA12WB Degree arm (Well)	PEI NEMA twist-lock PE (120, 208, 240V)	
		KMA Mast arm adapter	PE3 NEMA twist-lock PE (347V)	
		KTMB Twin mounting bar	PE4 NEMA twist-lock PE (480V)	
			PE7 NEMA twist-lock PE (2nVJ)	
			SC Shorting cap for PER option	
			KSAS House side shield (R2,R3)	
			KSF1VO Vandal guard	

- NOTES:
- Consult factory for availability in Canada.
 - Optional multi-tap ballast (120, 208, 240, 277V). (120, 175, 347V in Canada).
 - The SP09, RP09 or WN09 must be used when 120V or more luminaires are oriented on a square drilling pattern.
 - May be ordered as accessory.
 - Additional architectural colors available; please see paint brochure.
 - For arm mounting, refer to technical data section in the Monarch binder for drilling template:

Mounting Option	Drilling Template
SPIIX, APxx, OA12P	5
waxx, OA12WB	6
WVV:	7

Accessories: Tenon Mounting Spitter

Order separate catalog number. number of fixtures

Tenon O.D.	One	Two	Three	Four
2 1/8"	120-180	120-280	120-280	120-320
2-7/8"	125-180	125-280	125-280	125-320
4"	TIS-180	TIS-280	TIS-280	TIS-320

KSF1 175M Arm-Mounted Rectilinear Cutoff Lighting

..Coefficient of Utilization ———
 1 Initial footcandles ———

KSF1 R2 Test no. 1194090805

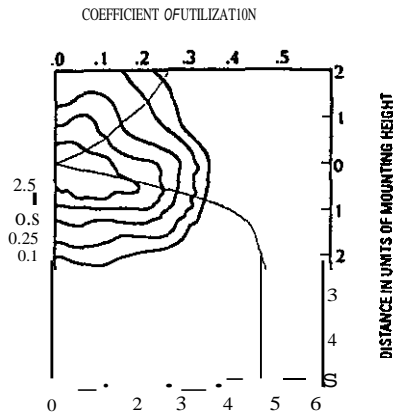

175W Metal Halide lamp, 13,400 rated lumen.
 Footcandle values based on 20' mounting height. Distribution Type II, cutoff.

KSF1 R3 Test no. 1194080403

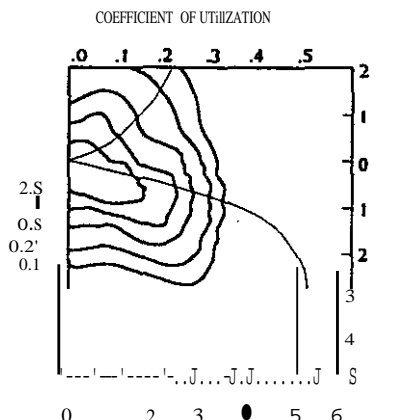

175W Metal Halide lamp, 13,400 rated lumen.
 Footcandle values based on 20' mounting height. Distribution Type III, HI cutoff.

KSF1 R4 Test no. 1194080909

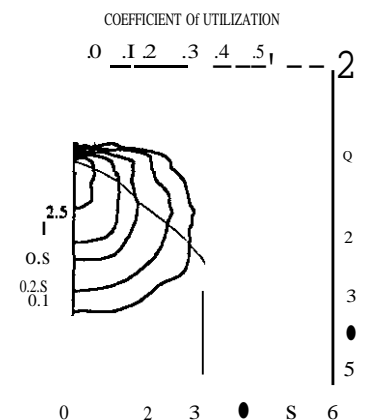

175W Metal Halide lamp, 13,400 rated lumen.
 Footcandle values based on 20' mounting height. Distribution Type IV, cutoff.

NOTES:

- For electrical characteristics, consult technical data tab.
- Tested to current IES and NEMA standards under stabilized laboratory conditions. Various operating factors can cause differences between laboratory and actual field measurements. Dimensions and specifications are based on the most current available data and are subject to change.

Mounting Height Correction Factor

(Multiply the fc level by the correction factor)
 15 ft. 1.77
 18 ft. 1.23
 25 ft. .64

$$\text{Existing Mounting Height}^1 \times \text{Correction Factor} = \text{New Mounting Height}$$

895-KSF1

C1992 Lithonia Lighting, Rev. 1/97
 895KSF1.PM5

LITHONIA LIGHTING
 SPECIFICATION OUTDOOR LIGHTING
 100 EAST ELMORE ST., CRAWFORDSVILLE, FLORIDA 34111-1311, TS. (813) 775-1111, FAX (813) 775-1111
 CANADA: 11005 CITH AV., L.A. CHINE, QUEBEC H7Y 1A1

FEATURES

SHAFT – Weldable grade hot-rolled commercial-quality carbon steel tubing with a minimum yield of 55,000 psi (7 gauge), 50,000 psi (11 gauge). Uniform wall thickness of .125" or .188". Shafts are one-piece with a longitudinal electric resistance weld. Uniformly square in cross-section with flat sides, small corner radii and excellent torsion. Available shaft widths are 4", 5" and 6".

ANCHOR BASE – Fabricated from hot-rolled carbon steel plate that meets or exceeds a minimum yield strength of 36,000 psi. The anchor base is provided with slotted holes.

HANDHOLE – A rectangular reinforced handhole rim having nominal dimensions of 3x5" for all shafts. Included is a steel cover with attachment screws.

GROUNDING – A nut holder located immediately inside the handhole rim is provided with a 1/T - 13 UNC ground bolt and nut.

ANCHOR BOLTS - Top 12" galvanized per ASTM A-153. Made of 3/4" or 1" diameter steel rod having a minimum yield strength of 55,000 psi.

HARDWARE – Fasteners are high-strength galvanized zinc-plated or stainless steel.

TOP CAP - Weatherproof, high-strength plastic cap standard for drill-mount poles.

FINISHES - Dark bronze (DOB) polyester powder finish standard. Other architectural colors available.

BASE COVER - Automotive-grade ABS plastic full-cover finished to match pole.

Catalog Number	Typ
SSS-10-4C-DM19-DDB	0175

Anchor Base Poles
SSS

SQUARE STRAIGHT STEEL
10' to 39' Mounting

SSS 4" SHAFT

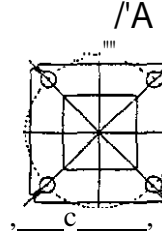

SSS 5" & 6" SHAFT

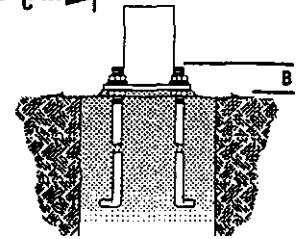
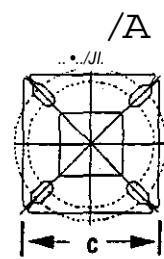

ORDERING INFORMATION

Choose the boldface catalog nomenclature that best suits your needs and write it in the appropriate blank.

Example: SSS305GDM19DOB

SSS	10	4C	DM19	DDB
Shaft type	Nominal mounting height	Nominal shaft base size/wall thickness	Mounting	Options
SSS	10-39 feet (See back page.)	(See back page.)	Tenon Mounting PT1 Open top T20 2-3/8" O.D. 12" NPSJ T25 2-7/8" O.D. 12-1/2" NPSJ T30 3-1/2" O.D. 13" NPSJ r352 4" O.D. (3-11/2" NPS) Drill Mounting DM19i3 1 at 90° DM28r1 2 at 1ao° DM28xPL ³ 2 at 180° wrth one side plugged DM29x ³ 2 at 90° DM39x ³ 3 at 90° DM49x ³ 4 at 90°	Architectural Colors (powder finish)* Standard Colors DOB Dark bronze DWH White DBL Slack Classic Colors DMB Medium bronze DNA NaWral aluminum DSS Sandstone DGC Charcoal gray Oro Tennis green DBR Bright red DSB Staal blue

Shaft Base Size	Bolt Circle A	Bolt Projection B	Base Square C	Anchor Bolt Description	Warehouse Anchor Description	Template Bolt Number
4-c	8-1/2"	2-3/4"-4'	8'	ABSSS-4C	AB18-0	PJ50004
4'G	8-11/2"	2-3/4"-4'	8"	ABSSS-4G	AB30-0	PJ50004
S*	10-12"	3-3/8"-4"	11"	ABSSS-5	A836-0	PJ50010
6'	11'-13'	3-3/8"-4'	12-11/2"	ASSSS-6	AB36-0	PJ50011

NOTES:

- 1 KKS series luminaire will fit 4" square poles only.
- 2 3-1/4" and 4" Tenons available on 5" and 6" shaft only.
- 3 The drilling template to be used for a particular luminaire depends on the luminaire that is used.

Replac. o/y= with	Drilling Template Difference Number	Drilling for Luminaire Stria
	1	ORCG1, ORDG1
2	2	KRES1
3	3	KRE1, KRES2, KRES1, ORCG2, OROG2
4	4	KRE2, I(S)ES2, ORC1, ORC2, OAD1, OR02
Blank	5	All other Lithonia Area luminaire

Refer to the Technical Order Section of the Monarch Binder for Drilling Templates.

- 4 Additional architectural colors available; see paint brochure.

IMPORTANT:

- Do not install poles without fixtures in place.
- Factory-supplied templates must be used when installing anchor bolts. Lithonia will not accept claim for incorrect installation due to failure to use factory supplied templates.
- If poles are stored outside, protective wrapping paper and cardboard must be removed immediately to prevent finish damage.

SSS Square Straight Steel Poles

TECHNICAL INFORMATION

Catalog Number	Nominal mounting height (feet)	Pole Shaft size (in x in x ft)	Wall Thickness (inches)	EPA lft ³ with 1.3 gust								Bolt Circle (inches)	Bolt Size Un. x in. x in. I	Approximate ship weight (pounds)
				Gauge	80 mph	Max. weight	90 mph	Max. weight	100 mph	Max. weight				
SSS 104C	10	4.0x 10.0	0.125	11	30.6	765	23.8	595	18.9	473	8-9	3/4x 18x3	75	
SSS 124C	12	4.0x 12.0	0.125	11	24.4	610	18.8	470	14.8	170	8-9	3/4x 18x3	90	
SSS 144C	14	4.0x 14.0	0.125	11	19.9	498	15.1	378	11.7	293	8-9	3/4x 18x3	100	
SSS 164C	16	4.0x 16.0	0.125	11	15.9	398	11.8	295	8.9	223	8-9	3/4x 18x3	115	
SSS 1B4C	18	4.0x 18.0	0.125	11	12.6	315	9.2	230	6.7	168	9	3/4x 18x3	125	
SSS 204C	20	4.0x 20.0	0.125	11	9.6	240	6.7	167	4.5	150	9	3/4x 18x3	140	
SSS 204G	20	4.0x 20.0	0.188	7	16.5	415	12.2	310	9.3	240	8-9	3/4x 30x3	198	
SSS 205C	20	5.0x 20.0	0.125	11	17.7	443	12.7	343	9.4	215	10-12	1x 36x4	185	
SSS 205G	20	5.0x 20.0	0.188	7	28.1	703	21.4	535	16.2	405	10-12	1x 36x4	265	
SSS 254C	25	4.0x 25.0	0.125	11	4.8	150	2.6	100	1.0	50	8-9	3/4x 18x3	170	
SSS 254G	25	4.0x 25.0	0.188	7	10.8	270	7.7	188	5.4	135	8-9	3/4x 30x3	245	
SSS 255C	25	5.0x 25.0	0.125	11	9B	245	6.3	157	3.7	150	10-12	1x 36x4	225	
SSS 255G	25	5.0x 25.0	0.188	7	19.3	480	14.0	350	10.0	250	10-12	1x 36x4	225	
SSS 305C	30	5.0x 30.0	0.125	11	4.7	150	2.0	50	--	--	10-12	1x 36x4	265	
SSS 305G	30	5.0x 30.0	0.188	7	10.7	267	6.7	167	3.9	100	10-12	1x 36x4	380	
SSS 306G	30	6.0x 30.0	0.188	7	15.7	392	10.2	257	6.4	160	11-13	1x 36x4	520	
SSS 355G	35	5.0x 35.0	0.188	7	5.9	150	2.5	100	--	--	10-12	1x 36x4	440	
SSS 356G	35	6.0x 35.0	0.188	7	9.5	237	5.0	150	1.8	50	11-13	1x 36x4	540	
SSS 396G	39	6.0x 39.0	0.188	7	5.1	128	1.3	33	--	--	11-13	1x 36x4	605	

BASE DETAIL SSS 4" SHAFT

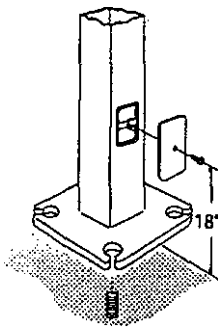

BASE DETAIL SSS 5" & 6" SHAFT

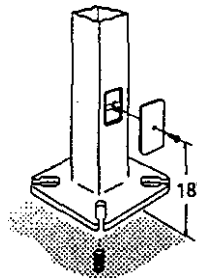

POLE OPTIONS

SUFFIX DESCRIPTION

FOL u	Festoon Outlet-less electrical
FGL L ₁	festoon GFI Outlet-less electrical
H1-18S ¹	Horizontal Arm Bracket-t fixture
VO	Vibration Damper (5" and 6" poles only)
LJK-B	Less Anchor Bolts
HH ¹	Extra Handhole

NOTES:

- 1 Specify location orientation when ordering specify orientation from handhole.
- 2 Consult factory for more details concerning felloon outlets.
- 3 Combination of Tenon-top and drill mount requires extra handhole.

IMPORTANT:

- These specifications are intended for general purposes only. Lithonia reserves the right to change specifications without prior notice. In continuing effort to upgrade all products.
- Installation requires grout to be placed under the base to ensure full contact with foundation.

135-POL.E

01994 Lithonia Lighting, Rev. 10S1
135-POLE.PM8

LITHONIA LIGHTING
SPECIFICATION OUTDOOR LIGHTING

115 EAST ELMORE ST., CRAWFORDVILLE, INDIANA 47113, TELEPHONE 715 382-1137, FAX 715 382-11083
N CANADK 1100 SOI HAYE, LA CHINE, QUEBEC H8T 2J3, A UNIT OF N.S.I. HOLDINGS, INC.

FEATURES

HOUSING - Rugged, .063" thick, lightweight aluminum rectangular housing. All seams are continuously welded for weather-tight seal and integrity. Standard finish is dark bronze (008) polyester powder finish. Other powder architectural colors available.

DOOR FRAME - Naturally anodized, extruded aluminum door frame with mitered corners is retained with (two) .188" diameter hinge pins and secured with (one) quarter-turn, quick release fastener. Weather-proof seal between housing and door frame is accomplished with an integrally designed, extruded silicone gasket that snaps into door frame.

LENS - .125" thick, impact-resistant, tempered glass with thermally-applied, silk screened power door shield.

MOUNTING - Extruded, 4" aluminum, arm for pole or wall mounting. Shipped in fixture carton. Optional mountings available.

OPTICS - Reflectors are anodized and segmented for superior uniformity and control, which allows the flexibility to mix distributions without compromising the overall lighting job. Reflectors attach with toolless fasteners and are rotatable and interchangeable. Three cutoff distributions available: Type II (Roadway), Type III (Asymmetric), Type IV (Forward Throw).

ELECTRICAL SYSTEM - Constant-wattage autotransformer ballast. Ballast is copper wound and 100% factory tested. Removable power door and positive locking disconnect plug.

SOCKET - Porcelain, horizontally-oriented, mogul-base socket with copper alloy, nickel plated screw shell and center contact. UL listed 1500W-600V.

LISTING - UL 1572 listed for wet locations. Listed and labeled to comply with Canadian standards (see options).

Catalog Number	Type
KSF1 175M-R4-277 SP04-0DB-SF-VG	E175

Arm-Mounted Rectilinear Cutoff Luminaire

MONARCH

KSF1 175M

175W METAL HALIDE
12' to 20' Mounting

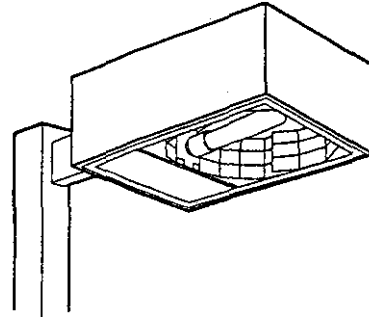

Standard dimensions

EPA: 1.5 ft² (.14m²) (includes arm)
Length: 22 (55.91)
Width: 16-3/16 (41.11)
Depth: 7-1/4 (18.4)
Weight 39 lbs (17.1kg)
Ann: 4 (10.2)

All dimensions are in inches (centimeter) unless otherwise specified.

ORDERING INFORMATION

Choose the boldface catalog nomenclature that best suits your needs and write it on the appropriate line. Order each KSF fixture separately.

Example: **KSF1175M R3 120 SP04 SF DOB**

	Volts	Mounting	Options
KSF1 175M	120	SP04 Square pole (4" arm)	Shipped Installed In Rxtura
Distribution	208 ¹	(standard)3	SF Single fuse (120, 277, 347V, n/a TB)
R2 IES Type II Roadway	240 ¹	SP09 Square pole (9" arm)	DF Double fuse (208, 240, 480V, n/a TB)
R3 IES Type III Asymmetric	347	RP04 Round pole (4" arm)	PER NEMA twist-lock receptacle
R4 IES Type IV Forward Throw	480 ¹	RP09 Round pole (9" arm)	only (no photocontrol)
	TB?	WW04 Wood pole or wall (4" arm)	ORS Quartz restrike system (75W max) (Uamp not included, 120V only)
		WW09 Wood pole or wall (9" arm)	EC Emergency Circuit
		WB04 Wall bracket (14" arm)	al Corrosion-resistant Finish
		WBOI Wall bracket (9" arm)	CSA Listed and labeled to comply with Canadian standards.
		MB Mounting bracket	
		UARM When ordering KMA, DA12	
		OPTIONAL MOUNTING	
		(shipped separately)	
		DA12P Degree arm Pole	Shipped separately
		DA12WB Degree arm (Wall)	PEI NEMA twist-lock PE (120, 208, 240V)
		KMA Mast arm adapter	PE3 NEMA twist-lock PE (347V)
		KTMB Twin mounting bar	PE4 NEMA twist-lock PE (480V)
			PE7 NEMA twist-lock PE 1mvl
			SC Shorting cap for PER option
			KSAHS House side shield (R2, R3)
			KSAVG Vandal guard
			Architectural Colors {powder finish?}
			Standard Colors
			DOB Dark bronze (standard)
			DWH White
			DBL Black
			Classic Colors
			DMB Medium bronze
			DNA Natural aluminum
			DSS Sandstone
			DGC Charcoal gray
			DTG Tennis green
			DBR Bright red
			DSB Steel blue

Accessories: Tenon Mounting S/Ipfitter

Order separate catalog number.
Number of fixtures

Tenon O.D.	One	Two	Three	Four
Mtr	1'20-110	1'20-280	1'20-290	1'20-320
2-7tr	f25-110	1'25-280	115-290	115-320
4'	1'35-110	1'35-280	T3S-290	T3S-320

L/THDN/A L/GHT/NG

SPECIFICATION OUTDOOR LIGHTING

695-KSF1

KSF1 175M Arm-Mounted Rectilinear Cutoff Lighting

— Coefficient of Utilization
 — Initial Footcandles

KSF1 R2 Test no. 1194090805

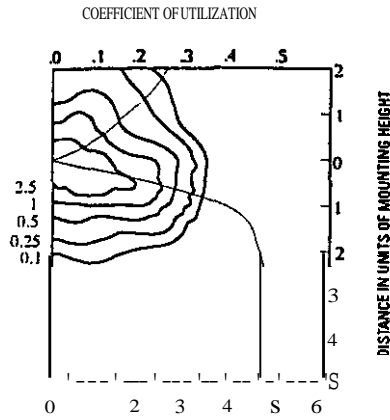

175W Metal Halide lamp, 13,400 rated lumen.
 Footcandle values based on 20' mounting height, Distribution Type II, cutoff.

KSF1 R3 Test no. 1194080403

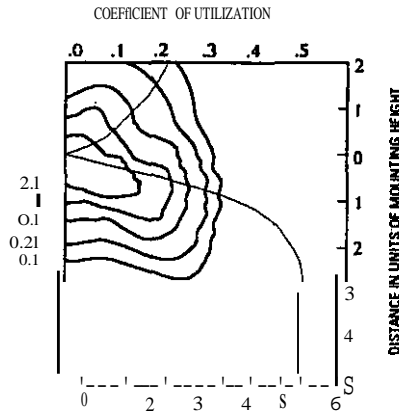

175W Metal Halide lamp, 13,400 rated lumen.
 Footcandle values based on 20' mounting height, Distribution Type III, cutoff.

KSF1 R4 Test no. 1194080909

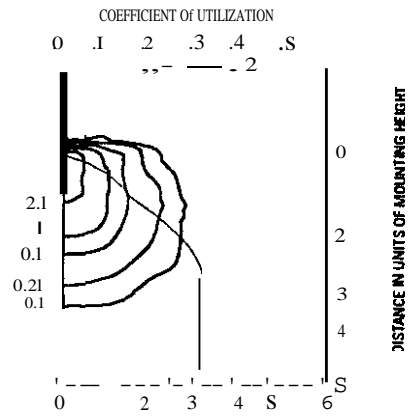

175W Metal Halide lamp, 13,400 rated lumen.
 Footcandle values based on 20' mounting height, Distribution Type IV, cutoff.

NOTES:

- For electrical characteristics, consult technical data tab.
- Tested to current IES and NEMA standards under controlled laboratory conditions. Various operating factors can cause differences between laboratory and actual field measurements. Illumination and footcandle values are based on the most current available data and are subject to change.

Mounting Height Correction Factor

(Multiply the fc level by the correction factor)

15ft. 1.77

18ft. 1.23

25 ft. .84

$$\frac{\text{Existing Mounting Height}^2}{\text{New Mounting Height}^2} = \text{Correction Factor}$$

LITHONIA LIGHTING

SPECIFICATION OUTDOOR LIGHTING

1115 EAST ELMORE ST., CMWFORDSYUE, INDIANA 47133, TELEPHONE 764-1117, FAX 117382-8083
 INCANADK 11001101M AVE., LACHINE, QUEBEC H1T 2Y3, A 1108, HOU>INGS, INC.

695-KSF1

C1992 Lithonia Lighting, Rev. 1197
 895KSF11: M5

Catalog Number

SSS-10-4C-DM19-DOB

Type

E175

FEATURES

SHAFT — Weldable grade hot-rolled commercial-quality carbon steel tubing with a minimum yield of 55,000 psi (17 gauge), 50,000 psi (11 gauge). Uniform wall thickness of .125" or .188". Shafts are one-piece with a longitudinal electric resistance weld. Uniformly square in cross-section with flat sides, small corner radii and excellent torsion. Available shaft widths are 4', 5' and 6'.

ANCHOR BASE — Fabricated from hot-rolled carbon steel plate that meets or exceeds a minimum yield strength of 36,000 psi. The anchor base is provided with slotted holes.

HANDHOLE — A rectangular reinforced handhole rim having nominal dimensions of 3x5' for all shafts. Included is a steel cover with attachment screws.

GROUNDING — A nut holder located immediately inside the handhole rim is provided with a 1/2" - 13 UNC ground bolt and nut.

ANCHOR BOLTS - Top 12" galvanized per ASTM A-153. Made of 3/4" or 1" diameter steel rod having a minimum yield strength of 55,000 psi.

HARDWARE — Fasteners are high-strength galvanized zinc-plated or stainless steel.

TOP CAP - Weatherproof, high-strength plastic cap standard for drill-mount poles.

FINISHES — Dark bronze IDDBJ polyester powder finish standard. Other architectural colors available.

BASE COVER - Automotive-grade ABS plastic full-cover finished to match pole.

Anchor Base Poles

SSS

SQUARE STRAIGHT STEEL
10' to 39' Mounting

SSS 4' SHAFT

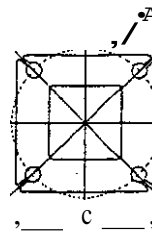

SSS 5' & 6' SHAFT

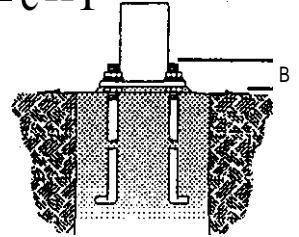
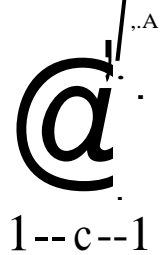

ORDERING INFORMATION

Choose the boldface catalog nomenclature that best suits your needs and write it in the appropriate blank.

Example: SSS305GOM19DOB

SSS	10	4C	DM19	DOB
Shaft type	Nominal mounting height	Nominal shaft base size/wall thickness	Mounting	Options
SSS	10-39 feet (See back page.)	(See back page.)	Tenon Mounting PT Open top T20 2-3/8" 0.0.12" NPSI T25 2-7/8" 0.0. (2-1/2)" NPSI TJO ² 3-1/2" 0.0.13" NPSI T35z 4" 0.0. (3-1/2)" NPSI Drill Mounting DM19.r1 1 at 90° DM28r 2 at 180° DM2BxPL ³ 2 at 180° with one side plugged DM29x' 1 at 90° DM39x ² 3 at 90° DM49x ² 4 at 90°	Architectural Colors (powder finish) Standard Colors DOB Dark-bronze DWH White DBL Black Classic Colors DMB Medium bronze ONA Natural aluminum DSS Sandstone DGC Charcoal gray DTG Tennis green DBR Bright red DSB Steel blue

Shaft Base Size	Bolt Circle A	Bolt Projection B	Base Square C	Anchor Bolt Description	Warehouse Anchor Description	Template Bolt Number
4C	8-1/2"	2-3/4"-4"	8"	ABSSS-4C	AB18-0	PJ50004
4G	8-1/2"	2-3/4"-4"	8"	ABSSS-4G	AB30-0	PJ50004
5'	10-12"	3-3/8"-4"	11"	ABSSS-5	AB36-0	PJ50010
6"	11"-13"	3-3/8"-4"	12-1/2"	ABSSS-6	AB36-0	PJ50011

NOTES:

- 1 KKS series luminaires will fit 4" square poles only.
- 2 3-112" and 4" Tenons available on Standard shaft only.
- 3 The drilling template to be used for a particular luminaire depends on the luminaire that is used.

Blank	Drilling Template Reference Number	Drilling for luminaire Series
1	1	ORCG1, ORDG1
2	2	KRES1
3	3	KRE1, KRES2, KSES1, ORCG2, ORDG2
4	4	KRE2, KSES2, ORC1, ORC2, ORD1, ORD2
Blank	5	All other Littleton Area Luminaire

Refer to the Technical Data Section of the Monarch Binder for Drilling Templates.

- 4 Additional architectural colors available; see paint brochure.

IMPORTANT:

- Do not erect pole without fixture in place.
- Factory-supplied templates must be used when setting anchor bolts. Lithonia will not accept claim for incorrect anchorage placement due to failure to use factory supplied.
- If poles are stored outside, protective wrapping paper and cardboard must be removed immediately to prevent finish damage.

SSS Square Straight Steel Poles

TECHNICAL INFORMATION

Catalog Number	Nominal mounting height (feet)	Pole Shaft size (in x in x ft)	Wall Thickness (inches)	Gauge	EPA (ft') with 1.3 gust						Bolt Circle (inches)	Bolt Size (in. x in. x in.)	Approximate ship weight (pounds)
					80 mph	Max. weight	90 mph	Max. weight	100 mph	Max. weight			
SSS 104C	10	4.0x 10.0	0.125	11	30.6	765	23.8	595	18.9	473	Ø	3/4x 18x3	75
SSS 124C	12	4.0x 12.0	0.125	11	24.4	610	18.8	470	14.8	370	Ø	3/4x 18x3	90
SSS 144C	14	4.0x 14.0	0.125	11	19.9	498	15.1	378	11.7	293	Ø	3/4x 18x3	100
SSS 164C	16	4.0x 16.0	0.125	11	15.9	398	11.8	295	8.9	223	Ø	3/4x 18x3	115
SSS 184C	18	4.0x 18.0	0.125	11	12.6	315	9.2	211	6.7	168	Ø	3/4x 18x3	125
SSS 204C	20	4.0x 20.0	0.125	11	9.6	240	6.7	167	4.5	150	Ø	3/4x 18x3	140
SSS 204G	20	4.0x 20.0	0.188	7	16.5	415	12.2	310	9.3	240	Ø	3/4x 30x3	198
SSS 20SC	20	5.0x 20.0	0.125	11	17.7	443	12.7	343	9.4	235	Ø	1x 36x 4	185
SSS 205G	20	5.0x 20.0	0.188	7	28.1	760	21.4	535	16.2	405	Ø	1x 36x 4	265
SSS 254C	25	4.0x 25.0	0.125	11	4.8	150	2.6	100	1.0	511	Ø	3/4x 18x3	170
SSS 254G	25	4.0x 25.0	0.188	7	10.8	270	7.7	188	5.4	135	Ø	3/4x 30x3	245
SSS 25SC	25	5.0x 25.0	0.125	11	9.8	245	6.3	157	3.7	150	Ø	1x 36x 4	225
SSS 255G	25	5.0x 25.0	0.188	7	19.3	480	14.0	350	10.0	250	Ø	1x 36x 4	225
SSS 30SC	30	5.0x 30.0	0.125	11	4.7	150	2.0	50	--	--	Ø	1x 36x 4	265
SSS 305G	30	5.0x 30.0	0.188	7	10.7	267	6.7	167	3.9	100	Ø	1x 36x 4	311
SSS 306G	30	6.0x 30.0	0.188	7	15.7	392	10.2	257	6.4	160	Ø	1x 36x 4	520
SSS 355G	35	5.0x 35.0	0.188	7	5.9	150	2.5	100	--	--	Ø	1x 36x 4	440
SSS 356G	35	6.0x 35.0	0.188	7	9.5	237	5.0	150	1.8	511	1H3	1x 36x 4	540
SSS 396G	39	6.0x 39.0	0.188	7	5.1	128	1.3	33	--	--	1H3	1x 36x 4	605

BASE DETAIL SSS 4" SHAFT

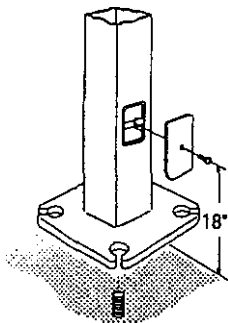

BASE DETAIL SSS 5" & 6" SHAFT

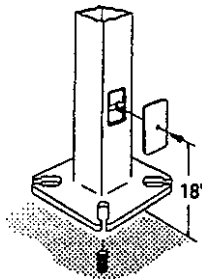

POLE OPTIONS

SUFFIX	DESCRIPTION
FOL u	Festoon Outlet - less electrical
FGL u	Festoon GFI Outlet - less electrical
H1-IBS u	Horizontal Arm Bracket - 1 fixture
VD	Vibration Damper (S9 and 6" poles only)
IAB	Less Anchor Bolts
HH u	Extra Handhole

IMPORTANT:

- These specifications are intended for general purposes only. Lithonia reserves the right to change materials or design, without prior notice, in its continuing effort to upgrade its products.
- Installation requires a hole to be drilled under the pole to ensure full contact with foundation.

NOTES:

1. Specify location/orientation when ordering (especially orientation from the end).
2. Consult factory for more detail concerning festoon outlets.
3. Combination of Tenon-top end drill mount requires extra handhole.

135-POLE

©1994 Lithonia Lighting, Rev. 10/97
135-POLE.PM8

LITHONIA LIGHTING

SPECIFICATION OUTDOOR LIGHTING

1815 EAST MORE ST. CRAWFORD, INDIANA 47133, TELEPHONE 715-312-1113, FAX 7382-11083
INCANAD.: 1100 HOLLIF AVE., LACHINE, QUEBEC H1M. A LITHONIA HOLDINGS, INC.

FEATURES

HOUSING -Rugged, .063" thick, lightweight aluminum rectangular housing. All *seams* are continuously welded for weather-tight seal and integrity. Standard finish is dark bronze (DOB) polyester powder finish. Other powder architectural colors available.

DOOR FRAME -Naturally anodized, extruded, aluminum door frame with mitered corners is retained with (two) .188" diameter hinge pins and secured with (one) quarter-turn, quick release fastener. Weather-proof seal between housing and door frame is accomplished with an integrally designed, extruded silicone gasket that snaps into door frame.

LENS - .125" thick, impact-resistant tempered glass with thermally-applied, silk screened power door shield.

MOUNTING - Extruded, 4" aluminum, arm for pole or wall mounting. Shipped in fixture carton. Optional mountings available.

OPTICS -Reflectors are anodized and segmented for superior uniformity and control, which allows the flexibility to mix distributions without compromising the overall lighting job. Reflectors attach with toolless fasteners and are rotatable and interchangeable. Three cutoff distributions available: Type II (Roadway), Type III (Asymmetric), Type IV (Forward Throw).

ELECTRICAL SYSTEM - Constant-wattage autotransformer ballast. Ballast is copper wound and 100% factory tested... Removable power door and positive locking disconnect plug.

SOCKET - Porcelain, horizontally-oriented, mogul-base socket with copper alloy, nickel-plated screw shell and center contact. UL listed 1500W-600V.

LISTING -UL 1572 listed for wet locations. Listed and labeled to comply with Canadian standards (see options).

Catalog Number	Type
KSF1 175M-R4 277-SP04-DDB-SF-VG	F175

MONARCH KSF1 175M

175W METAL HALIDE
12' to 20' Mounting

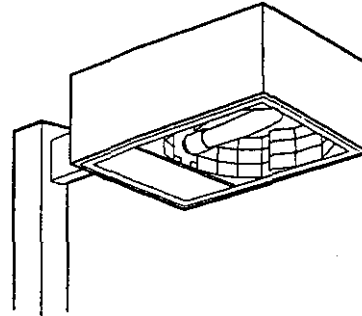

Standard dimensions

EPA: 1.5 fl.² (.14m²) (includes arm)
Length: 22 (55.91)
Width: 16-3/16 (41.11)
Depth: 7-1/4 (18.41)
Weight 39 lbs (17.7kg)
Arm: 4110.21

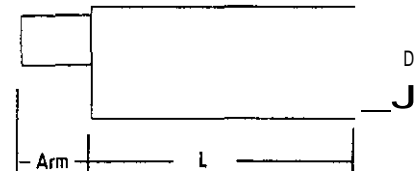

All dimensions are in inches (centimeteral unless otherwise specified).

ORDERING INFORMATION

Choose the boldface catalog nomenclature that best suits your needs and write it on the appropriate line. Order accessories as separate catalog number. Example: **KSF1 175MR3 120SP04 SF DDB**

KSF1	175M	R4	SP04	DD	• •	---
Series	Mounting	Options	Options	Options	Options	Options
KSF1 175M	SP04 Square pole (4' arm) Istandard ³	120	Shipped Installed In Fixture	Architectural Colors (powder finish)		
	SP09 Square pole (9' arm)	201 ¹	Sf Single fuse (120, 277, 347V, n/a TB)	Standard Colors		
	RP04 Round pole (4' arm) J	240 ¹	OF Double fuse 1208, 240, 48J, n/a TB	DOB Dark bronze (standard)		
	RP09 Round pole (9' arm)	217	PER NEMA twist-lock receptacle	DWH White		
	WW04 Wood pole or wall (4' arm) P	7		DBL Black		
	WW09 Wood pole or wall (9' arm)	4501		Classic Colors		
	WB04 Wall bracket (4' arm)	TBI		DMB Medium bronze		
	WB09 Wall bracket (9' arm)			DNA Natural aluminum		
	MB Mounting bracket			DSS Sandstone		
	UARM When ordering KMA, DA12			DGC Charcoal gray		
	OPTIONAL MOUNTING (shipped separately)			OTG Tennis green		
	DA12P Degree arm (Pole)			DBR Bright red		
	DA12WB Degree arm (Wall)			DSB Steel blue		
	KMA Mast arm adapter					
	KTMB Twin mounting bar					

Accessories: Tenon Mounting Sillfitter

Order as separate catalog number. Number of fixtures

Tenon O.D.	One	Two	Three	Four
2-3/16"	120-180	T10-290	T20-320	T20-390
2-7/16"	125-180	T25-290	T25-320	T25-390
4"	135-180	T35-290	T35-320	T35-390

KSF1 175M Arm-Mounted Rectilinear Cutoff Lighting

Coefficient of Utilization —
 initial Footcandles —

KSF1 R2 Test no. 1194090805

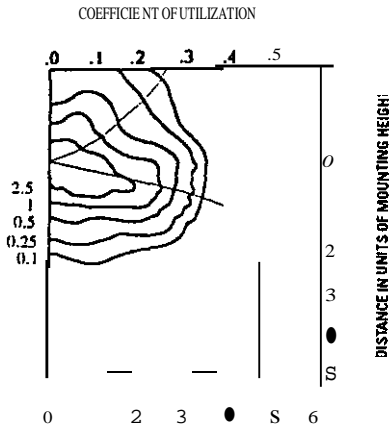

175W Metal Halide lamp, 13,400 rated lumen.
 Footcandle values based on 20' mounting height. Distribution Type II, cutoff.

KSF1 R3 Test no. 1194000403

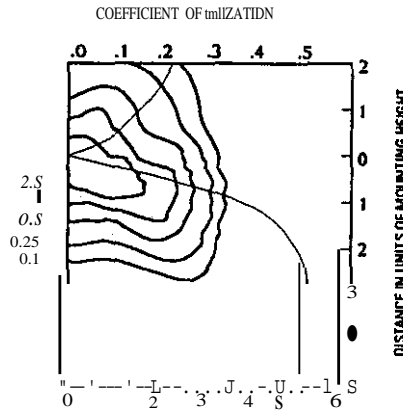

175W Metal Halide lamp, 13,000 rated lumen. Footcandle values based on 20' mounting height. Distribution Type III, cutoff.

KSF1 R4 Test no. 1194080909

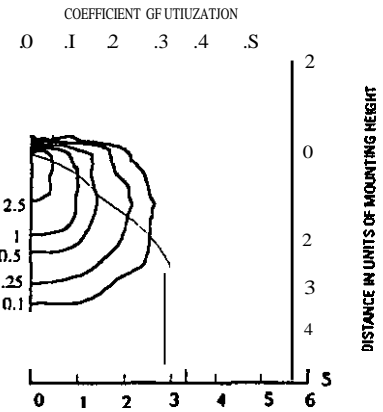

175W Metal Halide lamp, 13,400 rated lumen.
 Footcandle values based on 20' mounting height. Distribution Type IV, cutoff.

NOTES:

1. For electrical characteristics, consult technical data tab.
2. Tested to current IES and NEMA standards under idealized laboratory conditions. Various operating factors can cause differences between laboratory and actual field measurements. Dimensions and specifications are based on the most current available data and are subject to change.

Mounting Height Correction Factor

Multiply the level by the correction factor!
 15 ft. 0.77
 18 ft. 1.23
 25 ft. 0.84

$$\frac{\text{Existing Mounting Height}^2}{\text{New Mounting Height}^2} = \text{Correction Factor}$$

695-KSF1

C1992 Lithonia Lighting, Rev. 1/97
 69SKSF1.PM5

LITHONIA LIGHTING

SPECIFICATION OUTDOOR LIGHTING

11775 W. EASTMAN AVE., CRAWFORD, MISSISSIPPI 39231, TELEPHONE 662.887.1177, FAX 662.887.1178

INCORPORATED IN MISSISSIPPI

Catalog Number

SSS-12-4C-DM19-DDB

Typo

F175

FEATURES

SHAFT – Weldable grade hot-rolled commercial-quality carbon steel tubing with a minimum yield of 55,000 psi (7 gauge), 50,000 psi (11 gauge). Uniform wall thickness of .125" or .188". Shafts are one-piece with a longitudinal electric resistance weld. Uniformly square in cross-section with flat sides, small corner radii and excellent torsion. Available shaft widths are 4', 5' and 6".

ANCHOR BASE — Fabricated from hot-rolled carbon steel plate that meets or exceeds a minimum yield strength of 36,000 psi. The anchor base is provided with slotted holes.

HANDHOLE — A rectangular reinforced handhole rim having nominal dimensions of 3x5" for all shafts. Included is a steel cover with attachment screws.

GROUNDING — A nut holder located immediately inside the handhole rim is provided with a 1/2" - 13 UNC ground bolt and nut.

ANCHOR BOLTS - Top 12" galvanized per ASTM A-153. Made of 3/4" or 1" diameter steel rod having a minimum yield strength of 55,000 psi.

HARDWARE — Fasteners are high-strength galvanized zinc-plated or stainless steel.

TOP CAP — Weatherproof, high-strength plastic cap standard for drill-mount poles.

FINISHES - Dark bronze (DOB) polyester powder finish standard. Other architectural colors available.

BASE COVER - Automotive-grade ABS plastic full-cover finished to match pole.

Anchor Base Poles

SSS

SQUARE STRAIGHT STEEL
10' to 39' Mounting

SSS 4" SHAFT
1/A

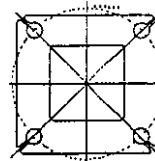

---C---

SSS 5-&6" SHAFT
A

---C---

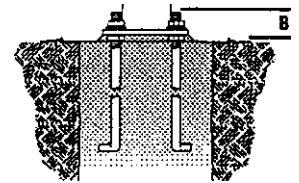

ORDERING INFORMATION

Choose the boldface catalog nomenclature that best suits your needs and write it in the appropriate blank.

Example: SSS 3056DM19DOB

SSS	12	4C	DM19	DDB
Shaft type SSS	Nominal mounting height 10-39 feet See back page.)	Nominal shaft base size/wall thickness See back page.)	Mounting Tenora Mounting: PT1 Open top T21 2-3/8" O.D. 12" NPSJ T2S 2-7/8" O.D. 12-1/2" NPSJ T302 3-1/2" O.D. 13" NPSJ n;z 4-0.0. f3-1/2" NPSJ Drill Mounting DM19r 1 at 111" DM21r 2 at 180" DM28xPL ³ 2 at 190" with one side plugged DMZ9x ³ 2 at 90" DM39x ³ 3 at 90" DM49x ³ 4 at 111"	Options Architectural Colors (powder finish) ⁴ Standard Colors DOB Dark bronze DWH White DBL Black Classic Colors DMB Medium bronze DNA Natural aluminum DSS Sandstone DGC Charcoal gray DTG Tennis green DBR Bright red DSB Steel blue

Shaft Base Size	Bolt Circle A	Bolt Projection B	Base Square C	Anchor Bolt Description	Warehouse Anchor Bolt Description	Template Bolt Number
4-C	B-1/2"	2-3/4"-4"	a	ABSSS-4C	AB18-0	PJ50004
4-G	B-1/2"	2-3/4"-4"	a	ABSSS-4G	AB3D-O	PJ50004
S	10-12	3-1/8"-4"	11	ABSSS-S	AB36-0	PJ50010
6"	11-13	3-3/8"-4"	12-1/2"	ABSSS-6	AB36-0	PJ50011

NOTES:

- 1 KKS series luminaires will fit 4" square poles only.
- 2 3-1/2" and 4" Tenons available on 5- and 6" shafts only.
- 3 The drilling template to be used for a particular luminaire depends on the luminaire that is used.

Drilling Template Reference Number	Drilling for Luminaire
1	ORCG1, OROG1
2	KRES1
3	KRE1, KRES2, KSES1, ORCG2, ORDG2
4	KRE2, KSES2, ORC1, ORC2, OR01, OR02
Blank	All other Lithonia Area Luminaires

Refer to the Technical Data Section of the Monarch Broder for Drilling Templates.

- 4 Additional architectural colors available; see paint brochure.

IMPOSSIBLE:

- Do not install poles without fixtures in place.
- Factory-supplied templates must be used when setting anchor bolts. Uthonit will not accept claim for incorrect anchor bolt placement due to failure to use factory template.
- If pole is installed outside, protective wrapping paper and cardboard must be removed immediately to prevent finish damage.

f DNA LIGHTING

SPECIFICATION OUTDOOR LIGHTING

135-POLE

SSS Square Straight Steel Poles

TECHNICAL INFORMATION

Catalog Number	Nominal mounting height (feet)	Pole Shaft Size (in x in x ft)	Wall Thickness (inches)	Gauge	EPA III ¹ with 1.3 gust						Bolt Circle (inches)	Bolt Size (in. x in. x in.)	Approximate ship weight (pounds)
					80 mph	Max. weight	90 mph	Max. weight	100 mph	Max. Weight			
SSS 104C	10	4.0 x 100	0.125	11	30.6	765	23.8	595	18.9	473	8--9	3/4 x 18 x 3	75
SSS 124C	12	4.0 x 12.0	0.125	11	44.4	610	18.8	470	14.8	370	8--9	3/4 x 18 x 3	90
SSS 144C	14	4.0 x 14.0	0.125	11	19.9	498	15.1	378	11.7	193	8--9	3/4 x 18 x 3	100
SSS 164C	16	4.0 x 16.0	0.115	11	15.9	398	11.8	295	8.9	213	8--9	3/4 x 18 x 3	115
SSS 184C	18	4.0 x 18.0	0.125	11	12.6	315	9.1	230	6.7	168	8--9	3/4 x 18 x 3	125
SSS 20 4C	10	4.0 x 20.0	0.115	11	9.6	40	6.7	167	4.5	111	8--9	3/4 x 18 x 3	140
SSS 20 4G	10	4.0 x 20.0	0.188	7	16.5	415	12.2	310	9.3	240	8--9	3/4 x 30 x 3	198
SSS 20 5C	10	5.0 x 20.0	0.115	11	17.7	443	12.7	343	9.4	215	10--11	1 x 36 x 4	185
SSS 20 5G	10	5.0 x 20.0	0.188	7	28.1	700	11.4	535	16.1	405	10--11	1 x 36 x 4	165
SSS 2S 4C	15	4.0 x 25.0	0.115	11	4.8	150	2.6	100	1.0	111	8--9	3/4 x 18 x 3	170
SSS 2S 4G	15	4.0 x 25.0	0.188	7	10.8	270	7.7	188	5.4	135	8--9	3/4 x 30 x 3	145
SSS 2S 5C	15	5.0 x 15.0	0.125	11	9.8	145	6.3	157	3.7	111	10--12	1 x 36 x 4	225
SSS 2S 5G	15	5.0 x 15.0	0.188	7	19.3	480	14.0	350	10.0	250	10--12	1 x 36 x 4	225
SSS 30 5C	30	5.0 x 30.0	0.115	11	4.7	150	2.0	50	--	--	10--12	1 x 36 x 4	165
SSS 30 5G	30	5.0 x 30.0	0.188	7	10.7	411	6.7	167	3.9	100	10--12	1 x 36 x 4	380
SSS 30 & G	30	6.0 x 30.0	0.188	7	15.7	392	10.1	157	6.4	100	11--13	1 x 36 x 4	510
SSS 3S 5G	35	5.0 x 35.0	0.188	7	5.9	150	2.5	100	--	--	10--12	1 x 36 x 4	440
SSS 3S 6G	35	6.0 x 35.0	0.188	7	9.5	237	5.0	150	1.8	111	11--13	1 x 36 x 4	540
SSS 39 & G	39	6.0 x 39.0	0.188	7	5.1	128	1.3	33	--	--	11--13	1 x 36 x 4	605

BASE DETAIL SSS 4" SHAFT

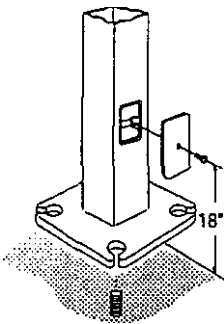

BASE DETAIL SSS 5" & 6" SHAFT

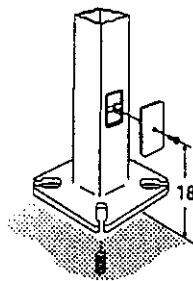

POLE OPTIONS

SUFFIX	DESCRIPTION
FOL u	Festoon Outlet -less electrical
FGL u	Festoon GFI OutJet -less electrical
H1-18S	Horizontal Arm Bracket - t fixture
VD	Vibration Damper 15" end 6" poles only)
I/AB	Less Anchor Bolts
HH'	Extra Handhole

NOTES:

- 1 Specify location orientation when ordering (*specify orientation from handhole).
- 2 Consult factory for more detail concerning festoon outjets.
- 3 Combination of Tenon-top and drill mount require extra handhole.

IMPORTANT:

- These specifications are intended for general purpose and not for use in hazardous or corrosive environments. Lithonia Lighting is not responsible for any damage to property or equipment caused by improper installation or use.
- Installation requires grout to be placed under the base to ensure full contact with foundation.

135-POLE

©1994 Lithonia Lighting, Rev. 10197
135-POLE.PM8

LITHONIA LIGHTING

SPECIFICATION OUTDOOR LIGHTING

111 EAST ELMORE ST., CRAWFORDSVILLE, INDIANA 47831, TELEPHONE 711-1011 S7, FAX 785 M2-1183
CANADA: 110050THAVE., LAURENCEVILLE, ONTARIO, CANADA

KSF2 400M Arm-Mounted Rectilinear Cutoff Lighting

— Coefficient of Utilization
 — Initial footcandle

KSF2 R2 ED-28 Test no. 1193031801

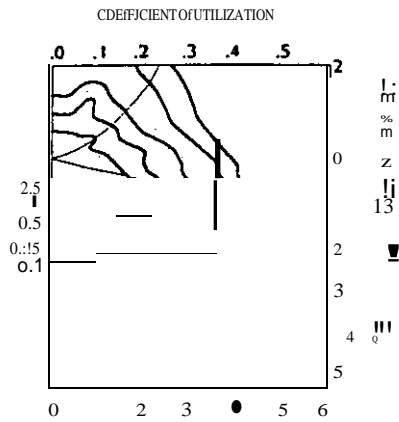

400W Metal Halide lamp, 32,000 rated lumens.
 Footcandle values based on 30' mounting height. Distribution Type II, cutoff.

KSF2 R3 ED-28 Test no. 1194100501

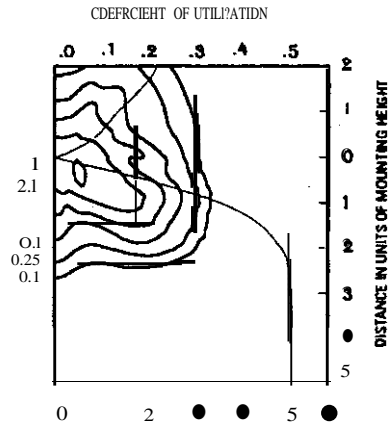

400W Metal Halide lamp, 32,000 rated lumens.
 Footcandle values based on 30' mounting height. Distribution Type III, cutoff.

KSF2 R4 ED-28 Test no. 1193041301

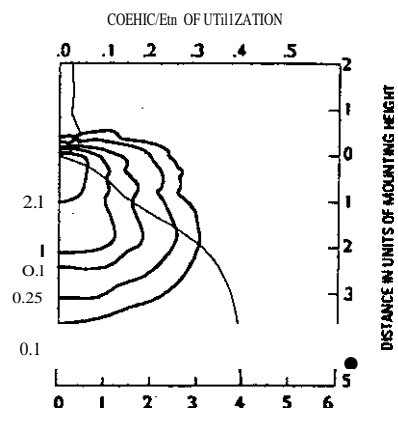

400W Metal Halide lamp, 32,000 rated lumens.
 Footcandle values based on 30' mounting height. Distribution Type IV, cutoff.

KSF2 R5S ED-28 Test no. 1193051801

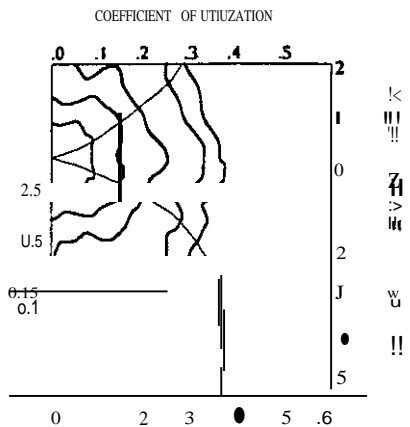

400W Metal Halide lamp, 32,000 rated lumens.
 Footcandle values based on 30' mounting height. Distribution Type V, cutoff.

NOTES:

- For electrical characteristics, consult technical data lab.
- Tested to current IES and NEMA standards under controlled laboratory conditions. Various operating factors can cause differences between laboratory and field measurements. Orientation and placement are based on the most current available data and are subject to change.

Mounting Height Correction Factor

Multiply the level by the correction factor)

- 25 ft • 1.44
- 32 ft • .88
- 35 ft • .73

Initial Footcandle : Connection factor
 New Mounting Height

FEATURES

SHAFT - Weldable grade hot-rolled commercial-quality carbon steel tubing with a minimum yield of 55,000 psi (7 gauge). 50,000 psi (1T gauge). Uniform wall thickness of .125" or .188". Shafts are one-piece with a longitudinal electric resistance weld. Uniformly square in cross-section with flat sides, small corner radii and excellent torsion. Available shaft widths are 4", 5" and 6".

ANCHOR BASE - Fabricated from hot-rolled carbon steel plate that meets or exceeds a minimum yield strength of 36,000 psi. The anchor base is provided with slotted holes.

HANDHOLE - A rectangular reinforced handhole rim having nominal dimensions of 3x5" for all shafts. Included is a steel cover with attachment screws.

GROUNDING - A nut holder located immediately inside the handhole rim is provided with a 1/2" - 13 UNC ground bolt and nut.

ANCHOR BOLTS - Top 12" galvanized per ASTM A-153. Made of 3/4" or 1" diameter steel rod having a minimum yield strength of 55,000 psi.

HARDWARE - Fasteners are high-strength galvanized zinc-plated or stainless steel.

TOP CAP - Weatherproof, high-strength plastic cap standard for drill-mount poles.

FINISHES - Dark bronze (DOB) polyester powder finish standard. Other architectural colors available.

BASE COVER - Automotive-grade ABS plastic full-cover finished to match pole.

Catalog Number	Type
SSS-20-5C-DM28-DOB	C400

Anchor Base Poles

SSS

SQUARE STRAIGHT STEEL
10' to 39' Mounting

SSS 4" SHAFT

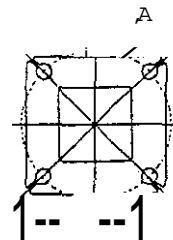

SSS 5" & 6" SHAFT

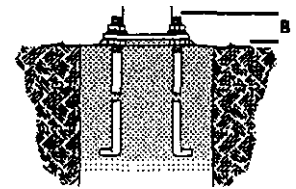
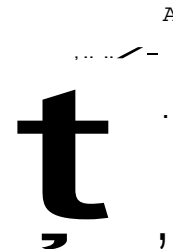

ORDERING INFORMATION

Choose the boldface catalog nomenclature that best suits your needs and write it in the appropriate blank.

Example: SSS305GDM19DOB

SSS	20	SC	DM28	DDS
Shaft type	Nominal mounting height	Nominal shaft base size/wall thickness	Mounting	Options
SSS	10-39 feet (See back page.)	(See back page.)	Tenon Mounting py1 Open top T20 2-3/8" 0.0.12' NPS TIS 2-7/8" 0.0.12-1/2' NPS T30 3-1/2" 0.0.13' NPS y351 4.0. (3/2" NPS)	Architectural Color (powder finish) Standard Colors DDS Dari-bronze DWH White DBL Black C11slicColor11 DMB Medium bronze DNA Natural aluminum DSS Sandstone DGC Charcoal OTO Tennis green DBR Bright red DSB Steel blue
			Drill Mounting DM19.r1 1at90° DM21.r 2 1tao° DM2bPL1 2 at 180° with one side gray plugged DM:ZS, 1 2 at 90° DM39x 3 3 at 90° DM49x 1 4 at 90°	

Shaft Base Size	Bolt Circle A	Bolt Projection B	Base Square C	Anchor Bolt Description	Warehouse Anchor Description	Template Number
4C	8-1/2"	2-3/4"-4"	4"	ABSSS-4C	AB18-0	PJ50004
4G	8-1/2"	2-3/8"-4"	5"	ABSSS-4G	AB36-0	PJ50004

NOTES:

- 1 KKS series luminares with n1 4" square pole only.
- 2 3-1/2" and 4" Tenons available on standard heights only.
- 3 The drilling template to be used for a particular luminaire depends on the luminaire that is used.

Replacement with	Drilling Template Reference Number	Drilling for Luminaire Strain
1		ORCGt, ORDGt
2	2	KRES
3	3	KREt, KRES2, KSES1, ORCG2, ORDG2
4		KRE2, KSES2, DRC1, ORC2, ORD1, ORD2
Blank	5	All other Lithonia Area Luminaires

Refer to the Technical Data Section of the Monarch Binder for Drilling Templates.

- 4 Additional architectural colors available; see print brochure.

IMPORTANT:

- Do not use poles without fixtures in place.
- Factory-supplied templates must be used when setting anchor bolts. Uthorn will not accept claim for incorrect anchor placement due to failure to use factory template.
- If poles are stored outside, protective wrapping paper and cardboard must be removed immediately to prevent finish damage.

SSS Square Straight Steel Poles

TECHNICAL INFORMATION													
Catalog Number	Nominal mounting height (feet)	Pole Shaft Size (in x in x ft)	Wall Thickness (inches)	Gauge	EPA ft ³ /h with 1.3 gust						Bolt Circle (inches)	Bolt Size (in. x in. x in.)	Approximate ship weight (pounds)
					80 mph	Max. weight	90 mph	Max. weight	100 mph	Max. weight			
SSS 104C	10	4.0x 10.0	0.125	11	30B	765	23.8	595	18.9	473	Ø	3/4 x 18x3	75
SSS 124C	12	4.0 x 12.0	0.125	11	24.4	610	18.8	470	14.8	370	Ø	3/4 x 18x3	90
SSS 144C	14	4.0x 14.0	0.125	11	19.9	498	15.1	378	11.7	293	Ø	3/4 x 18x3	100
SSS 164C	16	4.0x 16.0	0.125	11	15.9	398	11.8	295	8.9	223	8-9	3/4 x 18x3	115
SSS 184C	18	4.0 x 18.0	0.125	11	12.6	315	9.2	231	6.7	168	Ø	3/4 x 18x3	125
SSS 204C	20	4.0x 20.0	0.125	11	9.6	240	6.7	167	4.5	150	9-9	3/4 x 18x3	140
SSS 204G	20	4.0x 20.0	0.188	7	16.5	415	11.1	310	9.3	240	8-9	3/4 x 30x3	198
SSS 20SC	20	5.0x 20.0	0.125	11	17.7	443	12.7	343	9.4	215	10-12	1 x 36 x 4	185
SSS 205G	20	5.0x 20.0	0.188	7	28.1	713	21.4	535	16.2	400	10-12	1 x 36 x 4	265
SSS 254C	25	4.0 x 25.0	0.125	11	4.8	150	2.6	100	1.0	SJ	Ø	3/4 x 18x3	170
SSS 254G	25	4.0 x 25.0	0.188	7	10.8	270	7.7	188	5.4	135	Ø	3/4 x 30x3	245
SSS 25SC	25	5.0x 25.0	0.125	11	9.8	245	6.3	157	3.7	150	10-12	1 x 36 x 4	225
SSS 255G	25	5.0x 25.0	0.188	7	19.3	480	14.0	350	10.0	250	10-12	1 x 36 x 4	225
SSS 30SC	30	5.0x 30.0	0.125	11	4.7	150	2.0	50	--	--	10-12	1 x 36 x 4	175
SSS 305G	30	5.0 x 30.0	0.188	7	10.7	261	6.7	167	3.9	100	10-12	1 x 36 x 4	300
SSS 306G	30	6.0x 30.0	0.188	7	15.7	392	10.2	257	6.4	161	11-13	1 x 36 x 4	520
SSS 355G	35	5.0x 35.0	0.188	7	5.9	150	2.5	100	--	--	10-12	1 x 36 x 4	440
SSS 356G	35	6.0x 35.0	0.188	7	9.5	237	5.0	150	1.8	SJ	11-13	1 x 36 x 4	540
SSS 396G	39	6.0x 39.0	0.188	7	5.1	128	1.3	33	--	--	11-13	1 x 36 x 4	605

BASE DETAIL SSS 4" SHAFT

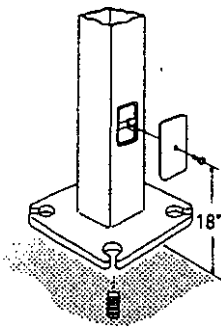

BASE DETAIL SSS 5" & 6" SHAFT

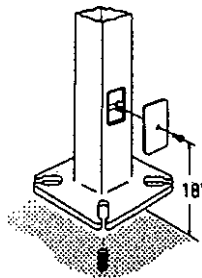

POLE OPTIONS

SUFFIX	DESCRIPTION
FOL _u	Festoon Outlet - less electrical
FGL _u	Festoon GFI Outlet - less electrical
HI-18S ¹	Horizontal Ann Bracket - 11xWre
VO	Vibration Dampener (5" and 6" poles only)
L/AB _{ess}	Anchor Bolts
HH _s	Extra Handhole

NOTES:

- Specify location and orientation when ordering. Specify orientation from handhole.
- Consult factory for mounting details.
- Combination of Tenon-top and drill mount requires extra handhole.

IMPORTANT:

- These specifications are intended for informational purposes only. Lithonia Lighting reserves the right to change specifications without prior notice, in continuing effort to upgrade its products.
- Installation requires grout to be picked under bottom of pole to ensure full contact with foundation.

135-POLE

©1994 Lithonia Lighting, Rev. 10/97
135.POLE.PM8

LITHONIA LIGHTING

SPECIFICATION OUTDOOR LIGHTING

11111 EAST ELMORE ST., CAAWFORDSVILLE, INDIANA 47111, TELEPHONE 1111112-1137, FAX 7111 H2-8083
IN CANADA: 11001101M AVL. u.o.a.NE. QUEBEC HIT M. A IMITOP N.1.1. HOLDINGS. INC.

FEATURES

HOUSING -Rugged, .063" thick, lightweight aluminum rectangular housing. All seams are continuously welded for weather-tight seal and integrity. Standard finish is dark bronze IDDB1 polyester powder finish. Other powder architectural colors available.

DOOR FRAME - Naturally anodized, extruded, aluminum door frame with mitered corners is retained with (two) .188" diameter hinge pins and secured with (one) quarter-turn, quick release fastener. Weather-proof seal between housing and door frame is accomplished with an integrally designed, extruded silicone gasket that snaps into door frame.

LENS - .125" thick, impact-resistant, tempered glass with thermally-applied, silk screened power door shield.

MOUNTING - Extruded, 4 aluminum, arm for pole or wall mounting. Shipped in fixture carton. Optional mountings available.

OPTICS - Reflectors are anodized and segmented for superior uniformity and control, which allows the flexibility to mix distributions without compromising the overall lighting job. Reflectors attach with toolless fasteners and are rotatable and interchangeable. Three cutoff distributions available: Type II (Roadway), Type III (Asymmetric), Type IV (Forward Throw).

ELECTRICAL SYSTEM - Constant-wattage autotransformer ballast Ballast is copper wound and 100% factory tested. Removable power door and positive locking disconnect plug.

SOCKET - Porcelain, horizontally-oriented, mogul-base socket with copper alloy, nickel-plated screw shell and center contact. UL listed 1500W-600V.

LISTING -UL 1572 listed for wet locations. Listed and labeled to comply with Canadian standards (see options).

Catalog Number	Type
KSF1 175M-R2-277-SP04-DDB-SF-VG	0175

Arm-Mounted Rectilinear Cutoff Lighting

MONARCH

KSF1 175M

175W METAL HALIDE

12' to 20' Mounting

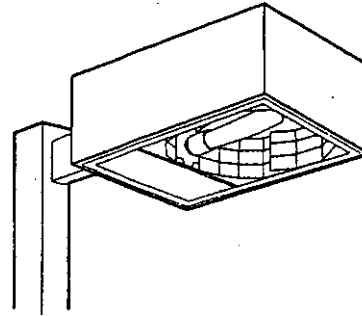

Standard dimensions

- EPA; 1.5ft.2 (.14m2) (includes arm)
- Length: 22 (5591)
- Width: 16-3/16 (41.11)
- Depth: 7-1/4 (11.41)
- Weight 39 lbs (17.7kg)
- Ann: 4(10.21)

All dimensions are in inches unless otherwise specified.

ORDERING INFORMATION

Choose the boldface catalog nomenclature that best suits your needs and write it on the appropriate line. Example: **KSF1175M R3 120 SP04 SF DOB**

KSF1	175M	120	SP04	DDB-SF-VG	1	1	1	1	1
-------------	-------------	------------	-------------	------------------	----------	----------	----------	----------	----------

KSF1 175M	120	SP04 Square pole {4" arm (standard)3}	Shipped Installed In Fixture	Architectural Colors (powder finish)
	208 ¹		Single fuse (120, 277, 347V, rt/a TB)	Standard Color
Distri bution	240 ¹	SP08 Square pole {9' arm}	DF Double fuse (208, 240, 480V, n/a TBI)	DOB Dark bronze (standard)
R2 IES Type II Roadway	2n	RP04 Round pole {4' arm} ³	PER NEMA twist-lock receptacle only (no photocontrol)	OWH White
R3 IES Type III Asymmetric	347	RPO1 Round pole {9' arm}	Quartz restrike system (75W maxi lamp not included, 110V only!	DBL Black
R4 IES Type IV Forward Throw	480 ¹	WW04 Wood pole or wall {4" arm}	EC Emergency Circuit	Classic Colors
	TB ²	WW09 Wood pole or wall {9' arm}	CR Corrosion-resistant Finish	DMB Medium bronze
		WB04 Well bracket {9' arm}	CSA Listed and labeled to comply with Canadian standards.	DNA Natural aluminum
		WBO1 Well bracket {9' arm}		DSS Sandstone
		MB Mounting bracket		DGC Charcoal gray
		1/ARM When ordering KMA, OA12		DTG Tennis green
				DBR Bright red
				DSB Steel blue

NOTES:

- Consult factory for availability in Canada. Optional multi-tip ballast (120, 208, 240, 217/1), (120, 2n, 347V In Canada).
- The SP09, RP09 or WN09 must be IJHd when two or more luminaires are oriented on a 90° drilling pattern.
- May be ordered in accessory.
- Additional architectural colors available; please see paint brochure.
- For arm mounting, refer to technical data section in the Monarch binder for drilling template: Mg11ntjng Optjgn Drmjnp Temnlst

SPxx., RPxx. DA12P	5
WBxx. DA12WB	6
WWu.	7

Accessories: Tenon Mounting Spiffitter

Order as separate catalog number & number of fixture

Tenon	One	Two	Three	Four
2-W	no-110	T>-280	I10-290	T20-320
2.7N	T2S-190	'125-280	'125-290	T2S-320
4"	T3S-190	T3S-280	T3S-290	T3S-320
				T>390
				TJ0-490
				'125-490
				T.15-490

L/THDNA LIGHTING

SPECIFICATION OUTDOOR LIGHTING

KSF1 175M Arm-Mounted Rectilinear Cutoff Lighting

..Coefficient of Utilization ———
Initial Footcandle ———

KSf1 R2 Test no. 1194090805

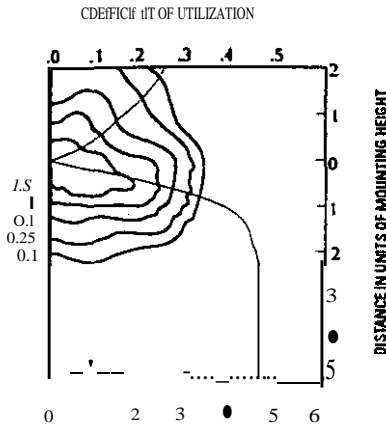

175W Metal H1Hde lamp, 13,400 rited lumen.
Footcandle values based on 20' mounting
height, Distribution Type II, cutoff.

KSf1 R3 Test no. 1194-080403

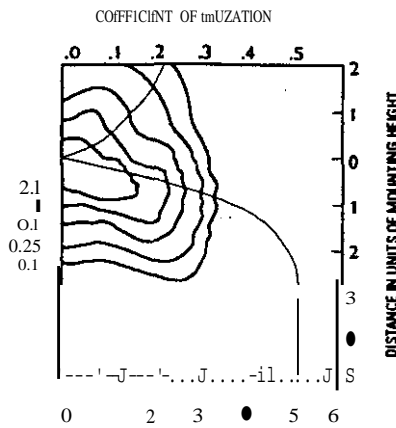

175W Metal Halldde lamp, 13400 rited
lumen. Footcandle value based on 20'
mounting height, Distribution Type III, cutoff.

KSf1 R4 Test no. 1194080909

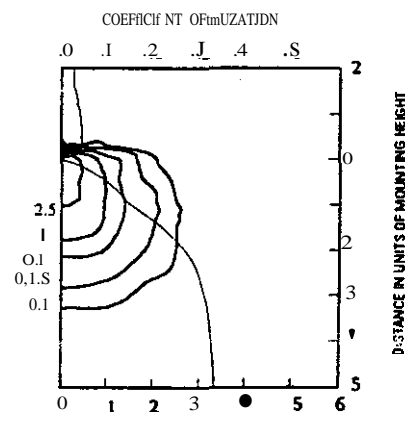

175W Metal H1Hde 11mp, 13<>0 rated lumens.
Footcandle value based on 20" mounting
height Oilltbuton Type IV, cutoff.

NOTES:

1. For electrical characteristics, consult technical data tab.
2. Tested to current IES and NEMA standards under simulated laboratory conditions. Various operating conditions can cause difference between laboratory and field measurements. Dimensions and specifications are based on the most current available data and are subject to change.

Mounting Height Correction Factor

Multiply the level by the correction factor.

- 15 ft. - 1.77
- 18 ft. - 1.23
- 25 ft. - .64

$$\frac{\text{Existing Mounting Height}^2}{\text{New Mounting Height}^2} = \text{Correction Factor}$$

895-KSF1

01992 Lithonia Lighting, Rev. 1/97
S95KSF1.PMS

LITHONIA LIGHTING
SPECIFICATION OUTDOOR LIGHTING
111 EAST ELMORE ST., CRAWFORDSVILLE, VA 24131, TEL: 434-771-1111, FAX: 434-771-1112
CANADA: 111-111-1111

FEATURES

SHAFT - Weldable grade hot-rolled commercial-quality carbon steel tubing with a minimum yield of 55,000 psi (7 gauge), 50,000 psi (11 gauge). Uniform wall thickness of .125" or .188". Shafts are one-piece with a longitudinal electric resistance weld. Uniformly square in cross-section with flat sides, small corner radii and excellent torsion. Available shaft widths are 4', 5" and 6".

ANCHOR BASE — Fabricated from hot-rolled carbon steel plate that meets or exceeds a minimum yield strength of 36,000 psi. The anchor base is provided with slotted holes.

HANDHOLE — A rectangular reinforced handhole rim having nominal dimensions of 3x5" for all shafts. Included is a steel cover with attachment screws.

GROUNDING — A nut holder located immediately inside the handhole rim is provided with a 1/2" - 13 UNC ground bah and nut.

ANCHOR BOLTS - Top 12" galvanized per ASTM A-153. Made of 3/4" or 1" diameter steel rod having a minimum yield strength of 55,000 psi.

HARDWARE — Fasteners are high-strength galvanized zinc-plated or stainless steel.

TOP CAP - Weatherproof, high-strength plastic cap standard for drill-mount poles.

FINISHES - Dark bronze (DOB) polyester powder finish standard. Other architectural colors available.

BASE COVER - Automotive-grade ABS plastic full-cover finished to match pole.

Catalog Number

SSS 10 4C-OM19-DDB

Type

0175

Anchor Base Poles

SSS

SQUARE STRAIGHT STEEL
10'to 39' Mounting

SSS 4" SHAFT

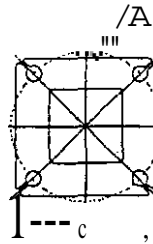

SSS 5" & 6" SHAFT

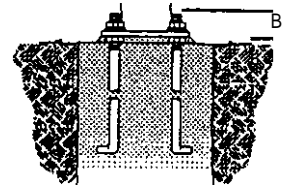

ORDERING INFORMATION

Choose the boldface catalog nomenclature that best suits your needs and write it in the appropriate blank.

Example: SSS3056DM19DOB

SSS		10		4C		DM19		DOB	
Shaft type	Nominal mounting height	Nominal shaft base size/wall thickness		Mounting		Options			
SSS	10-39 feet <small>See back page.1</small>	<small>(See back page.)</small>		Tenon Mounting PT1 Open top T20 2-3/8" 0.0. (2" NPS) T25 2-7/8" 0.0. 12-1/2 NPS T102 3-1/2" 0.0. (3" NPS) T352 4-0.0. (3-1/4" NPS)		Architectural Colors (powder finish) ⁴ Standard Colors DOB Dark bronze DWH White DBL Black C1111c Colors DMB Medium bronze DNA Natural aluminum DSS Sandstone DGC Charcoal gray DTG Tennis green DBR Bright red DSB Steel blue			
Drill Mounting DM19z1 1 at 90" DM21r 2 at 180" DM28xPL 2 at 180" with one side plugged DM29x3 2 at 90" DM39x3 3 at 90" DM49x1 1 at 90"									

Shaft Base Size	Bolt Circle A	Bolt Projection B	Base Square C	Anchor Bolt Description	Warehouse Anchor Description	Template Bolt Number
4"C	B-1/2"	2-3/4"-4"	8"	ABSSS-4C	AB1B-0	PJ50004
4"G	8-11/2"	2-3/4"-4"	8"	ABSSS-4G	AB30-0	PJ50004
5"	10-12"	3-3/8"-4"	11"	ABSSS-5	AB36-0	PJ50010
6"	14-13"	3-3/8"-4"	12-1/2"	ABSSS-6	AB36-0	PJ50011

NOTES:

- 1 KKS series luminaires will fit 4" square poles only.
- 2 3, 112 and 4 Tenons available on 5" and 6" shaft only.
- 3 The drilling template to be used for a particular luminaire depends on the luminaire that is used.

Application with	Drilling Template Reference N11mb11r	Drilling for luminaire S, rfn
1	1	ORCG1, ORDG1
2	2	KRES1
3	3	KRE1, KRES2, KSES1, ORCG2, ORDG2
4	4	KRE2, KSES2, ORC1, ORC2, ORD1, ORD2
Blank	5	All other Lithonia Area Luminaire 1

Refer to the Technical Data Section of the Monarch Blind for 01111r T.plates.
4 Additional architectural colors available; see Intro brochure.

IMPORTANT:

- Do not use bolts without fixtures in place.
- Factory-supplied templates must be used when using 1/2 inch bolts. Union will not accept claim for incorrect anchorage placement due to failure to use factory template.
- If poles are to be installed outdoors, protective wrapping and cladding must be removed immediately to prevent finish damage.

LITHONIA LIGHTING

SPECIFICATION OUTDOOR LIGHTING

135-POLE

SSS Square Straight Steel Poles

TECHNICAL INFORMATION

Catalog Number	Nominal mounting height (feet)	Pole Shaft Size (in x in x ft)	Wall Thickness (inches)	Gauge	EPA Int. 71 with 1.3 gust						Bolt Circle (inches)	Bolt Size (in. x in. x in.)	Approximate ship weight (pounds)
					80 mph	Max. weight	90 mph	Max. weight	100 mph	Max. weight			
SSS 104C	10	4.0 x 10.0	0.125	11	30.6	765	23.8	595	18.9	473	8--9	3/4 x 18 x 3	75
SSS 124C	12	4.0 x 12.0	0.125	11	24.4	610	18.8	470	14.8	370	8--9	3/4 x 18 x 3	90
SSS 144C	14	4.0 x 14.0	0.125	11	19.9	498	15.1	378	11.7	293	8--9	3/4 x 18 x 3	100
SSS 164C	16	4.0 x 16.0	0.125	11	15.9	398	11.8	295	8.9	223	8--9	3/4 x 18 x 3	115
SSS 184C	18	4.0 x 18.0	0.125	11	12.6	315	9.2	211	6.7	168	8--9	3/4 x 18 x 3	125
SSS 204C	20	4.0 x 20.0	0.125	11	9.6	240	6.7	167	4.5	150	8--9	3/4 x 18 x 3	140
SSS 204G	20	4.0 x 20.0	0.188	7	16.5	415	12.2	310	9.3	240	8--9	3/4 x 30 x 3	198
SSS 205C	20	5.0 x 20.0	0.125	11	17.7	443	12.7	343	9.4	235	10--12	1 x 36 x 4	185
SSS 205G	20	5.0 x 20.0	0.188	7	28.1	703	21.4	535	16.2	411	10--12	1 x 36 x 4	265
SSS 254C	25	4.0 x 25.0	0.125	11	4.8	150	2.6	100	1.0	50	8--9	3/4 x 18 x 3	170
SSS 254G	25	4.0 x 25.0	0.188	7	10.8	270	7.7	188	5.4	135	8--9	3/4 x 30 x 3	245
SSS 255C	25	5.0 x 25.0	0.125	11	9.8	245	6.3	157	3.7	150	10--12	1 x 36 x 4	225
SSS 255G	25	5.0 x 25.0	0.188	7	19.3	480	14.0	350	10.0	250	10--12	1 x 36 x 4	225
SSS 305C	30	5.0 x 30.0	0.125	11	4.7	150	2.0	50	--	--	10--12	1 x 36 x 4	265
SSS 305G	30	5.0 x 30.0	0.188	7	10.7	271	6.7	167	39	100	10--12	1 x 36 x 4	300
SSS 306G	30	6.0 x 30.0	0.188	7	15.7	392	10.2	257	6.4	181	11--13	1 x 36 x 4	520
SSS 355G	35	5.0 x 35.0	0.188	7	5.9	150	2.5	100	--	--	10--12	1 x 36 x 4	440
SSS 356G	35	6.0 x 35.0	0.188	7	9.5	237	5.0	150	1.8	50	11--13	1 x 36 x 4	540
SSS 396G	39	6.0 x 39.0	0.188	7	5.1	128	1.3	33	--	--	11--13	1 x 36 x 4	1105

BASE DETAIL SSS 4" SHAFT

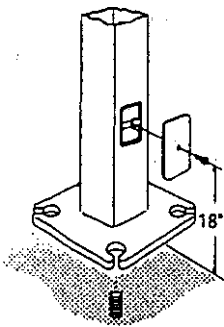

BASE DETAIL SSS 5" & 6" SHAFT

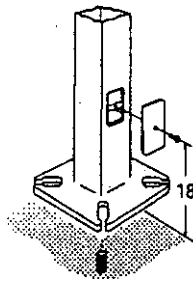

POLE OPTIONS

SUFFIX DESCRIPTION

FOL 11	Festoon Outlet -less electrical
FGL u	Festoon GFI Outlet -less electrical
H1-18S 1	Horizontal Arm Bracket -t fixture
VD	Vibration Damper (11" and 6" poles only)
V B	Less Anchor Bolts
HH'	Extra Handhole

NOTES:

- 1 Specify k>catlon or kln lallon when ordering {specify or fentttlon from handhole.
- 2 Contult fl dorjfor more details concerning felloon outSet.
- 3 Combined On of Tenon, top and drill mount require e lCre handhole.

IMPORTANT:

- Tioae 1p lltifeiorm lre inllnded for tntrtl purpout only. lithonil tenrvH th right to ch-nv• mtttrtl or dt l lgn, without prior nolkt, ln l continuing tffort fo upgrldt il productl.
- Instllation tflurM grout to bt pthd undtt bt l l to ln l ur l ful context with found l tion.

135-POLE

01994 Ulhonia Ughdng, Rev. 10/97
135-POLE.PM6

FLITHONIA LIGHTING

SPECIFICATION OUTDOOR LIGHTING

1115 EAST ELMOAT ST., CRAWFORDSVILLE, INDIANA 47133, T.B.E. HONE 7m3112-tl37, FAX 7C11M2-D3
NCANADA: UOa 50nt AYE., LACHIN: QUEBEC HIT 2Y3. A1., l, lIT OFN. SJ. HOLDINGS. INC.

FEATURES

HOUSING - Rugged, .063" thick, lightweight aluminum rectangular housing. All seams are continuously welded for weather-tight seal and integrity. Standard finish is dark bronze IDDBI polyester powder finish. Other powder architectural colors available.

DOOR FRAME - Naturally anodized, extruded, aluminum door frame with mitered corners is retained with (two) .188" diameter hinge pins and secured with (one) quarter-turn, quick release fastener. Weather-proof seal between housing and door frame is accomplished with an integrally designed, extruded, silicone gasket that snaps into door frame.

LENSES - .125" thick, impact-resistant, tempered glass with thermally applied, silk screened power door shield.

MOUNTING - Extruded, 4" aluminum, arm for pole or wall mounting. Shipped in fixture carton. Optional mountings available.

OPTICS - Reflectors are anodized and segmented for superior uniformity and control, which allows the flexibility to mix distributions without compromising the overall lighting job. Reflectors attach with toolless fasteners and are rotatable and interchangeable. Three cutoff distributions available: Type II (Roadway), Type III (Asymmetric), Type IV (Forward Throw).

ELECTRICAL SYSTEM - Constant-wattage autotransformer ballast. Ballast is copper wound and 100% factory tested. Removable power door and positive locking disconnect plug.

SOCKET - Porcelain, horizontally-oriented, mogul-base socket with copper alloy, nickel-plated screw shell and center contact. UL listed 1500W-600V.

LISTING - UL 1572 listed for wet locations. Listed and labeled to comply with Canadian standards (see options).

Catalog Number	Typo
KSF1-175M-R4-277-SP04-DDB-SF VG	E175

Arm-Mounted Rectilinear Cutoff LP™ In9

KSF1 175M

175W METAL HAUGE
12'to 20' Mounting

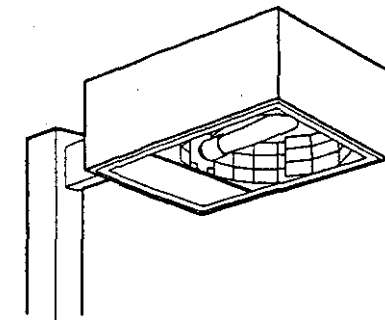

Standard dimensions

EPA: 1.5 ft² (.14m²) includes arm)
Length: 22 (SS.91)
Width: 16-3/16 141.11
Depth: 11/4 118.41
Weight 39lbs (17.1kg)

Arm: 4 (10.2)

All dimensions are in inches unless otherwise specified.

ORDERING INFORMATION

Choose the boldface catalog nomenclature that best suits your needs and write it on the appropriate line. Order accessories as separate catalog number. Example: **KSF1 175M R4 -2'R- I? 04** DDB-SF-VG

Model	Height	Mounting	Options
KSF1 175M	120, 208'	SP04 Square pole (4" arm) (standard)	Shipped Installed In Fixture SF Single fuse (120, 277, 347V, n/a TB) Architecture Colors (powder finish Standard Colors)
Distribution	240'	SP09 Square pole (9" arm)	DOB Dark bronze (standard)
R2 IES Type U Roadway	2n	RP04 Round pole (4' arm)	OF Double fuse (208, 240, 4SOV, n/a TB) OWH White
R3 IES Type III Asymmetric	347	RP09 Round pole (9' arm)	DBL Black
R4 JES Type IV Forward Throw	480', TB'	WWQ.4 Wood pole or wall (4" arm) WW09 Wood pole or wall (9' arm) WB04 Well bracket (4' arm)	C1 ssic Colors DMB Medium bronze DNA Natural aluminum DSS Sandstone DGC Charcoal gray DTG Tennis green OBR Bright red OSB Steel blue

NOTES:
Consult factory for availability in Canada.
Optional multi-tap ballast (120, 208, 240, 277V, 347V, 347V in Canada).
The SP09, RP09 or WWQ.4 must be used when two or more luminaires are oriented on a 90° drilling pattern.
May be ordered as accessory.
Additional architectural colors available; please see paint brochure.
For arm mounting, refer to technical data section in the Monarch binder for drilling template.
Mounting Option Qty Qty

Tenon 0.0.	One	Two	Three	Four
2-	120-190	120-280	1'2f.290	1'2f.320
2-7/0	1'25-190	1'25-280	f15.290	f15.320
4'	1'35-190	1'35-280	1'35-290	1'35-320

L/THDN/A L/GHT/NG

SPECIFICATION OUTDOOR UGtmNO

KSF1 175M Arm-Mounted Rectilinear Cutoff Lighting

..... Coefficient of Utilization —
 | Initial footcandle value —

KSF1 R2 Test no. 1194090805

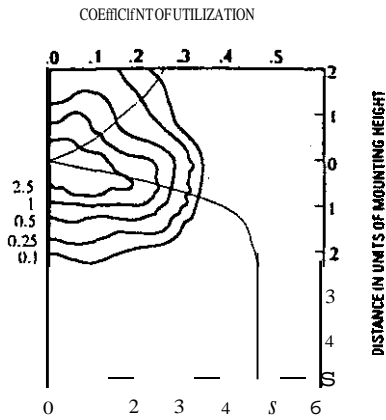

175W Metal Halide lamp, 13,000 rated lumen*.
 Footcandle value based on 20' mounting
 height, Distribution Type II, cutoff.

KSF1 R3 Test no. 1194080403

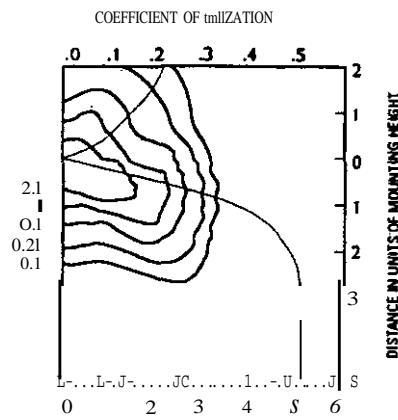

175W Metal Halide lamp, 13,400 rated
 lumen*. Footcandle value based on 20'
 mounting height, Distribution Type III, cutoff.

KSF1 R4 Test no. 1194080909

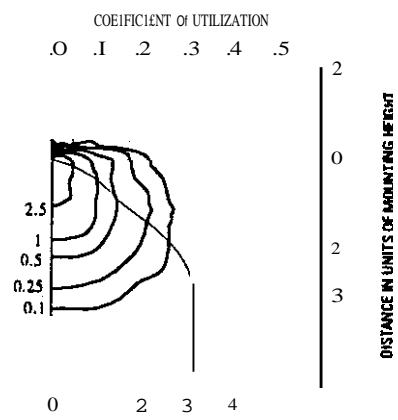

175W Metal Halide lamp, 13,400 rated lumen*.
 Footcandle values based on 20' mounting
 height, Distribution Type IV, cutoff.

NOTES:

1. For electrical characteristics, consult technical data table.
2. Tested to current IES and NEMA standards under controlled laboratory conditions. Variations in mounting factor can cause differences between laboratory and actual field measurements. Dimensions and specifications are based on the most current available data and are subject to change.

Mounting Height Correction Factor

(Multiply the fc level by the correction factor)

- 15ft. • 1.77
- 18ft. • 1.23
- 25ft. • .84

Existing Mounting Height • Correction Factor
 (Existing Mounting Height)¹

695-KSFt

01992 Outdoor Lighting, Rev. 1197
 895KSF1.MS

f • **L/THDNIA LIGHTING**
 SPECIFICATION OUTDOOR LIGHTING

815 EAST LEMORE ST., CRAWFORDSVILLE, INDIANA 41111, 11 LEHIGH & 1171 G-1137, FAX 317 382-8137
 MILCANADK 11001101 MAVE.. LACHWE. OUEBECHIT M.A UNIT OF ENL. HOUSINGS. INC.

FEATURES

SHAFT — Weldable grade hot-rolled commercial-quality carbon steel tubing with a minimum yield of 55,000 psi (17 gauge), 50,000 psi (11 gauge). Uniform wall thickness of .125" or .188". Shafts are one-piece with a longitudinal electric resistance weld. Uniformly square in cross-section with flat sides, small corner radii and excellent torsion. Available shaft widths are 4", 5" and 6".

ANCHOR BASE — Fabricated from hot-rolled carbon steel plate that meets or exceeds a minimum yield strength of 36,000 psi. The anchor base is provided with slotted holes.

HANDHOLE — A rectangular reinforced handhole rim having nominal dimensions of 3x5" for all shafts. Included is a steel cover with attachment screws.

GROUNDING — A nut holder located immediately inside the handhole rim is provided with a 1/2" - 13 UNC ground bolt and nut

ANCHOR BOLTS — Top 12" galvanized per ASTM A-153. Made of 3/4" or 1" diameter steel rod having a minimum yield strength of 55,000 psi.

HARDWARE — Fasteners are high-strength galvanized zinc-plated or stainless steel.

TOP CAP - Weatherproof, high-strength plastic cap standard for drill-mount poles.

FINISHES - Dark bronze (008) polyester powder finish standard. Other architectural colors available.

BASE COVER - Automotive-grade ABS plastic full-cover finished to match pole.

Catalog Number

SSS-10-4C-DM19-DDB

Type

E175

Anchor Base Poles

SSS

SQUARE STRAIGHT STEEL
10' to 39' Mounting

SSS 4" SHAFT

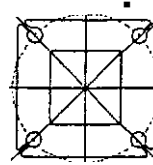

1--C--|

SSS 5" & 6" SHAFT

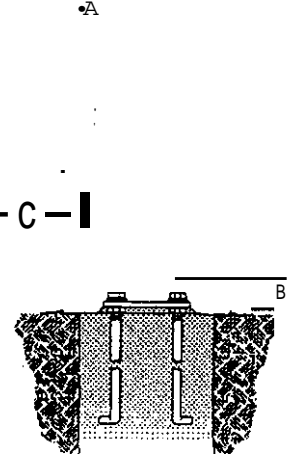

1--C--|

ORDERING INFORMATION

Choose the boldface catalog nomenclature that best suits your needs and write it in the appropriate blank.

Example: SSS31156OM19DOB

SSS	10	4C	DM19	DOB
Shaft type SSS	Nominal mounting height 10-39 feet (See back page.)	Nominal shaft base size/ wall thickness (See back page.)	Mounting Tenon Mounting PTI Open top T20 2-3/8" 0.0.12" NPSJ T25 2-7/8" 0.0.12-1/2" NPSJ TJO 3-1/2" 0.0.13" NPSJ T352 4' 0. D. (3/4" 12" NPSJ Drill Mounting DM19.r 1 at go- DM28.r 2 at 180° DM21xPL ³ 2 at 90° with one side plugged OM29x ³ 2 at 90° DM39x ³ 3 at 90° DM49x ¹ 4 at 90°	Options Architectural Color {powder finish} ⁴ Standard Colors DOB Carbon bronze DWH White DBL Black Classic Colors DMB Medium bronze DNA Nawral aluminum DSS Sandstone OGC Charcoal gray DTG Tennis green DBR Bright red DSB Steel blue

Shaft Base Size	Bolt Circle A	Bolt Projection B	Base Square C	Anchor Bolt Description	Warehouse Anchor Bolt Description	Template Bolt Number
4C	8-1/2"	1-3/4"-4"	2"	ABSSS-4C	AB18-0	PJ50004
4G	8-1/2"	1-3/4"-4"	2"	ABSSS-4G	A830-0	PJ50004
5"	10-1/2"	1-3/8"-4"	1 1/4"	ABSSS-5	AB36-0	pJ500.10
6"	11'-13"	3-3/8"-4"	12-1/2"	ABSSS-6	A836-0	PJ50011

NOTES:

- KICS series luminaires will fit 4" square poles only.
- 3-1/2" and 4" Tenons available on 8" end 8" shafts only.
- The drilling template 10 be used for a particular luminaire depends on the luminaire that is used.

Replicate "t" with	Drilling Template Reference Number	Drilling for Luminaire Size
1	1	ORCG1, ORDG1
2	2	ICRES1
3	3	KRE1, ICRES2, KSES1, ORCG2, ORDG2
4	4	ICRE2, KSES2, ORC1, ORC2, ORD1, ORD2
Blank	5	All other luminaire Area Luminaire

Refer to the Technical Data Section of the Monarch 8/Dder for Drilling Templates.

- Additional architectural colors available; see paint brochure.

IMPORTANT:

- Do not erect poles without roof in place.
- Factory supplied template must be used when string anchor bolts. Luminaire will not accept cleim for incorrect tilt or lge plclm Int du l fl!ur l 10 us factory ttmpl ltl.
- If pole is stored outside, protect it with wrapping paper and cardboard must be removed immediately to prevent finish damage.

(LITHONIA LIGHTING

SPECIFICATION OUTDOOR LIGHTING

135-POLE

SSS Square Straight Steel Poles

TECHNICAL INFORMATION

Catalog Number	Nominal mounting height (feet)	Pole Shaft Size (in. x ft)	Wall Thickness (inches)	Gauges	EPA (ft) with 1.3 gust						Bolt Circle (inches)	Bolt Size (in. x in. x in.)	Approximate ship weight (pounds)
					80 mph	Max. weight	90 mph	Max. weight	100 mph	Max. weight			
SSS 104C	10	4.0x10.0	0.125	11	30.6	765	23.8	595	18.9	473	8--9	3/4x18x3	75
SSS 124C	12	4.0x12.0	0.125	11	24.4	610	18.8	470	14.8	370	8--9	3/4x18x3	111
SSS 144C	14	4.0x14.0	0.125	11	19.9	498	15.1	378	11.1	293	8--9	3/4x18x3	100
SSS 164C	16	4.0x16.0	0.125	11	15.9	398	11.8	295	8.9	223	8--9	3/4x18x3	115
SSS 184C	18	4.0x18.0	0.125	11	12.6	315	9.2	230	6.7	168	8--9	3/4x18x3	125
SSS 204C	20	4.0x20.0	0.125	11	9.6	240	6.7	167	4.5	150	8--9	3/4x18x3	140
SSS 204G	20	4.0x20.0	0.188	7	16.5	415	12.2	310	9.3	240	8--9	3/4x30x3	1911
SSS 20 SC	20	5.0x20.0	0.125	11	17.7	443	12.7	343	9.4	235	10--12	1x36x4	185
SSS 20 5G	20	5.0x20.0	0.188	7	28.1	703	21.4	535	16.2	405	10--12	1x36x4	265
SSS 254C	25	4.0x25.0	0.125	11	4.8	150	2.6	100	1.0	50	8--9	3/4x18x3	170
SSS 25 4G	25	4.0x25.0	0.188	7	10.5	270	7.7	188	5.4	135	8--9	3/4x30x3	245
SSS 25 SC	25	5.0x25.0	0.125	11	9.8	245	6.3	157	3.7	150	10--12	1x36x4	225
SSS 25 5G	25	5.0x25.0	0.188	7	19.3	481	14.0	350	10.0	250	10--12	1x36x4	225
SSS 30 SC	30	5.0x30.0	0.125	11	4.7	150	2.0	80	--	--	10--12	1x36x4	265
SSS 30 5G	30	5.0x30.0	0.188	7	10.7	271	6.7	167	3.9	100	10--12	1x36x4	100
SSS 30 6G	30	6.0x30.0	0.188	7	15.7	392	10.1	257	6.4	111	11--13	1x36x4	520
SSS 35 5G	35	5.0x35.0	0.188	7	5.9	150	2.5	100	--	--	10--12	1x36x4	440
SSS 35 6G	35	6.0x35.0	0.188	7	9.5	237	5.0	150	1.8	50	11--13	1x36x4	540
SSS 39 6G	39	6.0x39.0	0.188	7	5.1	128	1.3	33	--	--	11--13	1x36x4	605

BASE DETAIL SSS 4" SHAFT

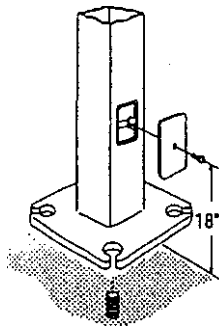

BASE DETAIL SSS 5" & 6" SHAFT

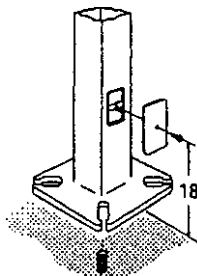

POLE OPTIONS

SUFFIX	DESCRIPTION
FOL _{1,1}	Festoon Outlet -less electrical
FGL _{1,2}	Festoon GFI Outlet -less electrical
H1-18S ¹	Horizontal Ann Bracket -1fixture
VO	Vibration Damper 15" end 6" poles only)
IJAB	less Anchor Bolts
HH ¹	Extra Handhole

NOTES:

- Specify callout when ordering (Specify orientation from handhole).
- Consult for more detail concerning outlet locations.
- Combination of Tenon-top and drill mount requires extra handhole.

IMPORTANT:

- This specification is intended for use only for the purpose of providing information to the right to the manufacturer or designer, without prior notice, in a continuing effort to improve its products.
- In the event of a requirement for grout to be packed and bolted to ensure full contact with foundation.

135-POLE

©1994 Lithonia Lighting, Rev. 10/97
135-POLE.PM&

(LITHONIA LIGHTING

SPECIFICATION OUTDOOR LIGHTING

1815 EAST ELMOAE ST. CRAWFORDSVILLE, INDIANA 479-D. TEL. PHONE 78&3112-1831 FAX. 785 382-11C83
IN CAHADK 110050TH AVE., LACHINE, QUEBEC H1T 2Y3, A DIVISION OF N.S.T. HOLDINGS, INC.

FEATURES

HOUSING - Rugged, .063" thick, lightweight aluminum rectangular housing. All seams are continuously welded for weather-tight seal and integrity. Standard finish is dark bronze 1008) Polyester powder finish. Other powder architectural colors available.

DOOR FRAME - Naturally anodized, extruded, aluminum door frame with mitered corners is retained with (two) .188" diameter hinge pins and secured with (one) quarter-turn, quick release fastener. Weather-proof seal between housing and door frame is accomplished with an integrally designed, extruded silicone gasket that snaps into door frame.

LENS - .125" thick, impact-resistant tempered glass with thermally-applied, silk screened power door shield.

MOUNTING - Extruded, 4" aluminum, arm for pole or wall mounting. Shipped in fixture carton. Optional mountings available.

OPTICS - Reflectors are anodized and segmented for superior uniformity and control, which allows the flexibility to mix distributions without compromising the overall lighting job. Reflectors attach with toolless fasteners and are rotatable and interchangeable. Three cutoff distributions available: Type II (Roadway), Type III Asymmetric, Type IV (Forward Throw).

Removable power door and positive locking disconnect--plug.

SOCKET - Porcelain, horizontally-oriented, mogul-base socket with copper alloy, nickel-plated screw shell and center contact. UL listed 1500W-600V.

LISTING - UL 1572 listed for wet locations. Listed and labeled to comply with Canadian standards (see options).

Catalog Number	KSF1 175M-R4-277-SP04-DDB-SF VG	Type	F175
----------------	---------------------------------	------	------

Arm-Mounted Rectilinear Cutoff L19" long

KSF1 175M

175W METAL HALIDE

12' to 20' Mounting

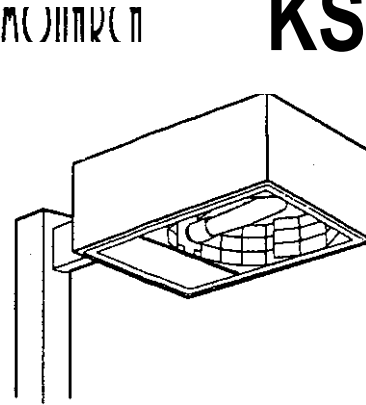

Standard dimensions

- EPA: 1.5 ft.2 (.14m2) (includes arm)
- Length: 22 (55.9)
- Width: 16-3/16 (41.11)
- Depth: 7-1/4 (18.41)
- Weight 39 lbs (17.7kg)
- Arm: 4 (10.2)



All dimensions are in inches (centimeters unless otherwise specified).

ORDERING INFORMATION

Choose the boldface catalog nomenclature that best suits your needs and write it on the appropriate line. Order Exam ple: **KSF1175M R3 120 SP04 SF 008**

series	Mounting	Options
KSF1 175M	SP04 Square pole (4" arm) (standard)	Shipped Installed In Fixture SF Single fuse (120, 277, 347V, n/a TB)
Distribution	SPC1 Square pole (9" arm)	OF Double fuse (208, 240, 480V, n/a TB)
R2 ES Type II Roadway	RP04 Round pole (4" arm) ³	PER NEMA twist-lock receptacle only (no photocontrol)
R3 ES Type III Asymmetric	RPO1 Round pole (9" arm)	OM Quartz restrika system (75W max) (lamp not included, 120V only)
R4 JES Type IV forward Throw	WW04 Wood pole or wall (4" arm)	EC Emergency Circuit
	WN09 Wood pole or wall (9" arm)	CR Corrosion resistant Finish
	WB04 Wall bracket (4" arm)	CSA Listed and labeled to comply with Canadian standards.
	WBO1 Wall bracket (9" arm)	
	MB Mounting bracket	Shipped separately'
	UARM When ordering KMA, DA12'	PE1 NEMA twist-lock PE (t20, 208, 200V)
		PD NEMA twist-lock PE (347V)
		PE4 NEMA twist-lock PE (480V)
		PE7 NEMA twist-lock PE (InV)
		SC Shorting cap (OJ PER option)
		KSF1HS House side shield (R2,R3)
		KSF1VG Vonda! guard

OPTIONAL MOUNTING (shipped separately)
 DA12P Degree ann (Pole)
 DA12WB Degree ann (Wall)
 KMA Mast arm adapter
 ICTMB Twin mounting bar

Notes:
 1 Consult factory for availability in Canada.
 2 Optional multi-tap ballut 1120, 208, 240, 277V. (120, 277, 347V in Canada).
 3 The SP09, RP09 or WW01 must be used when two or more luminaires are oriented on a 90° drilling pattern. May be ordered as accessory. Additional architectural colors available; please see paint brochure.
 6 For arm mounting, refer to technical data section in the Monarch binder for drilling template;
Mounting Option Drilling Template

SPIOL, RPo, DA12P
 WBIIX, DA12WB
 WWW.X 7

Accessories: Tson Mounting Slipfitters

Order et sepa. rHe catalog number.
 umber of fixture1

Tenon 0.0.	One	TwoC180°	Two090°2	Three0120°	Three090°1	Four090°2
2-3/8"	1'20-180	1'20-280	T10-280	T10-320	1'20-380	T20-490
2-7/8"	T2S-180	T2S-280	f2S.280	f2S.320	1'25-380	T25-490
4"	T3S-180	T3S-280	T.15-280	T.15-320	T3S-380	T3S-490

KSF1 175M Arm-Mounted Rectilinear Cutoff Lighting

Coefficient of Utilization —
Initial Footcandle

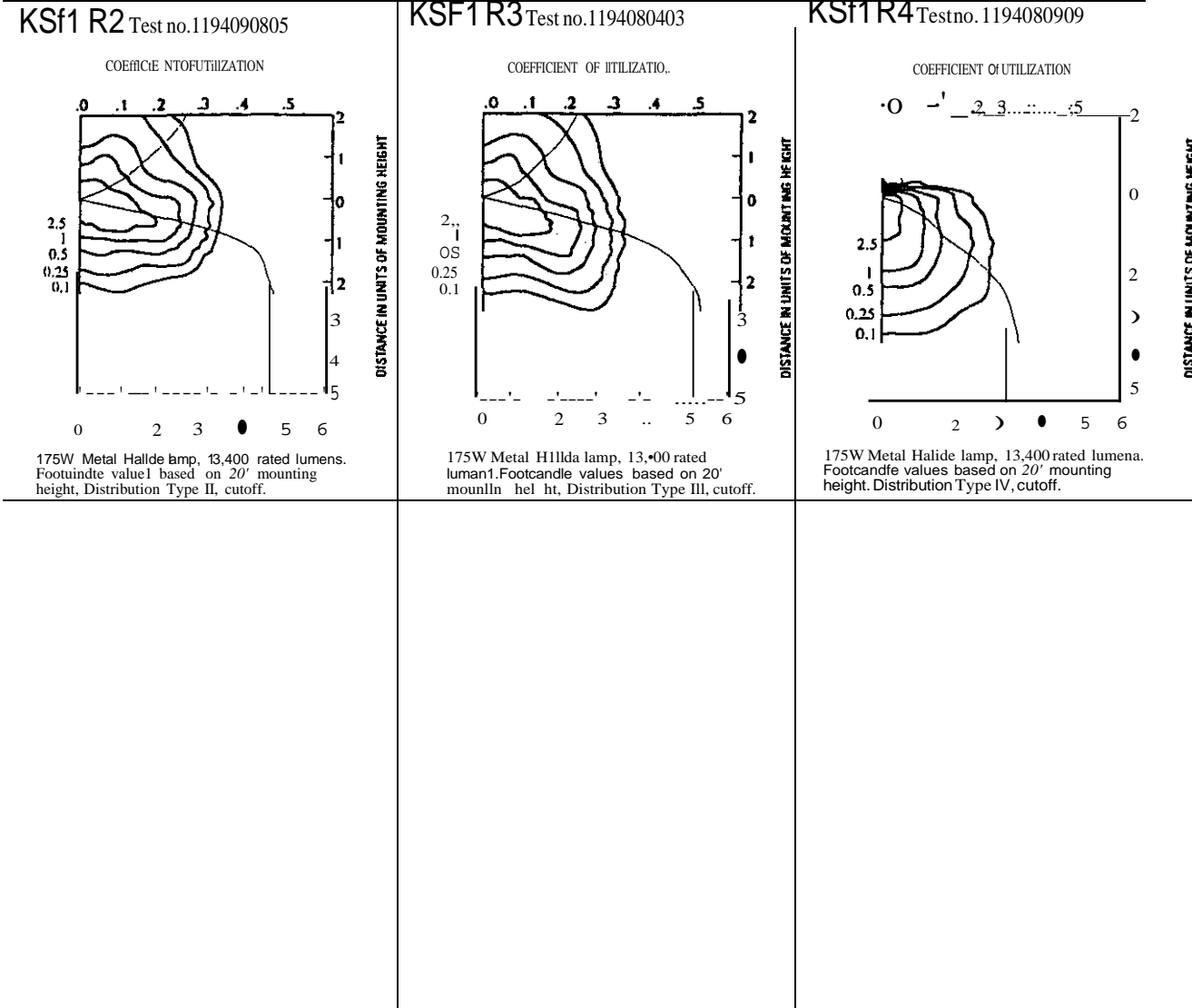

NOTES:

- For electrical characteristics, consult technical data tab.
- Tested to current IES and NEMA standards under ideal laboratory conditions. Various operating factors can cause differences between laboratory and field measurements. Dimensions and specifications are based on the most current available data and are subject to change.

Mounting Height Correction Factor

Multiply the ft. level by the correction factor)

15 ft. • 1.77

18 ft. • 1.23

25 ft. • .84

$$\frac{\text{Existing Mounting Height}^2}{\text{New Mounting Height}^2} = \text{Correction Factor}$$

69S.KSF1

01992 Lithonia Lighting, Rev. 1/97
89S(KSF1)FMS

LITHONIA LIGHTING

SPECIALIZATION OUTDOOR LIGHTING

118 EAST ELMORE ST., INDIANAPOLIS, IN 46202-1190 TEL: 317-251-1111 FAX: 317-251-1111
CANADA: 1100 AVENUE L, QUEBEC, QUEBEC, CANADA H3L 1M0 TEL: 514-351-1111 FAX: 514-351-1111

FEATURES

SHAFT — Weldable grade hot-rolled commercial-quality carbon steel tubing with a minimum yield of 55,000 psi (17 gauge), 50,000 psi (11 gauge). Uniform wall thickness of .125" or .188". Shafts are one-piece with a longitudinal electric resistance weld. Uniformly square in cross-section with flat sides, small corner radii and excellent torsion. Available shaft widths are 4", 5" and 6".

ANCHOR BASE — Fabricated from hot-rolled carbon steel plate that meets or exceeds a minimum yield strength of 36,000 psi. The anchor base is provided with slotted holes.

HANDHOLE — A rectangular reinforced handhole rim having nominal dimensions of 3x5" for all shafts. Included is a steel cover with attachment screws.

GROUNDING — A nut holder located immediately inside the handhole rim is provided with a 1/2" - 13 UNC ground bolt and nut.

ANCHOR BOLTS - Top 12" galvanized per ASTM A•153. Made of 3/4" or 1" diameter steel rod having a minimum yield strength of 55,000 psi.

HARDWARE — Fasteners are high-strength galvanized zinc-plated or stainless steel.

TOP CAP — Weatherproof, high-strength plastic cap standard for drill-mount poles.

FINISHES - Dark bronze (DOB) polyester powder finish standard. Other architectural colors available.

BASE COVER - Automotive-grade ABS plastic lull-cover finished to match pole.

Catalog Number

SSS-12-4C-OM19-00B

Type

F175

Anchor Base Poles

SSS

SQUARE STRAIGHT STEEL
10' to 39' Mounting

SSS 4" SHAFT

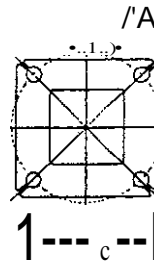

SSS 5" & 6" SHAFT

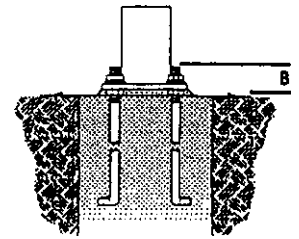
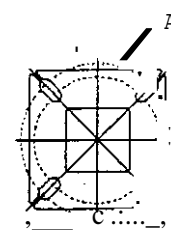

ORDERING INFORMATION

Choose the boldface catalog nomenclature that best suits your needs and write it in the appropriate blank.

Example: SSS 3056DM19DOB

SSS	12	4C	DM19	DOB
Shaft type SSS	Nominal mounting height 10-39 feet See back page.1	Nominal shaft base size/ wall thickness (See back page.1)	Mounting Tenon Mounting: PT1 Open top T20 2-1/8" O.D. 12" NPSI T25 2-7/8" O.D. 12-1/2" NPSI T31 3-1/2" O.D. 13" NPSI T1S1 1" O.D. 13-1/2" NPSI Drill Mounting: DM19x1 1 at 90" DM21x1 2 at 180° DM21xPL3 2 at 180° with one side plugged DM29x1 1 at 90" DM39x3 3 at 190" DM49x1 1 at 90"	Options Architectural Colors {powder finish} ⁴ Standard Colors DDS Dark bronze DWH White DBL Black CII Isic Colors DMB Medium bronze DNA Natural aluminum DSS Sandstone DGC Charcoal gray DTG Tenflis green DBR Bright red DSB Steel blue

Shaft Base Size	Bolt Circle A	Bolt Projection B	Base Square C	Anchor Bolt Description	Warehouse Anchor Bolt Number	Template Description
4-C	B-1/2'	2-3/4"-4"	2"	ABSSS-4C	AB1B-0	PJ50004
4"G	B-112'	2-3/4"-4"	e-	ABSSS-4G	A830-0	PJ50004
5•	10-12-	3-3/8"-4"	11-	ABSSS-5	AB36-0	PJ50010
6'	11-13-	3-3/a"-4"	12-1/2'	ABSSS-6	AB36-0	

NOTES:

- 1 KKS series luminaires will fit 4" square poles only.
- 2 3/12" and 4" Tenons available on 5" and 6" shafts only.
- 3 The drilling template to be used for a particular luminaire depends on the luminaire that is used.

Replaces "W" wbb	Drilling Template Reference	Drilling for luminaire Serfu
1	1	ORCG1, 0ADG1
2	2	KRES1
3	3	KRE1, KRES2, Jr.; SES1, ORCG2, OROG2
4	4	KRE2, KSES2, ORC1, ORC2, ORD1, OR02
Blank	5	AH other Lfihoni• Area luminaire

Refer to the Technical Data Section or the Monarch Binder for Drilling Templates.

- 4 Addition• architectural colors available; paint brochure.

INSTALLATION:

- Do not use brackets without fixtures in place.
- Factory supplied template must be used when mounting tenon bolts. The hole will not locate the luminaire for correct tenon placement. Mounting to the luminaire factory template.
- If pole is to be installed outside, protect the luminaire with a protective cap and cover the luminaire with a weather-resistant material.

f LIGHTING

SPECIFICATION OUTDOOR LIGHTING

135-POLE

SSS Square Straight Steel Poles

TECHNICAL INFORMATION

Catalog Number	Nominal mounting height (feet)	Pole Shaft size (in x in x ft)	Wall Thickness (inches)	Gauge	EPA (ft) with 1.3 gust						Bolt Circle (inches)	Bolt Size (in. x in. x in.)	Approximate ship weight (pounds)
					80 mph	Max. weight	90 mph	Max. weight	100 mph	Max. weight			
SSS 104C	10	4.0x 10.0	0.125	11	30.6	765	23.8	595	18.9	473	8--9	3/4x 1Bx3	75
SSS 124C	12	4.0x 12.0	0.125	11	24.4	610	18.8	470	14.8	370	8--9	3/4x 1Bx3	90
SSS 144C	14	4.0x 14.0	0.125	11	19.9	498	15.1	378	11.7	293	8--9	3/4x 1Bx3	100
SSS 164C	16	4.0x 16.0	0.125	11	15.9	398	11.8	295	8.9	223	8--9	3/4x 1Bx3	115
SSS 184C	18	4.0x 18.0	0.125	11	12.6	315	9.1	231	6.7	168	8--9	3/4x 1Bx3	125
SSS 204C	20	4.0x 20.0	0.125	11	9.6	240	6.7	167	4.5	100	8--9	3/4x 1Bx3	140
SSS 204G	20	4.0x 20.0	0.188	7	16.5	415	12.1	310	9.3	240	8--9	3/4x 30x3	198
SSS 205C	20	5.0x 20.0	0.125	11	17.7	443	12.7	343	9.4	215	10--12	1x 36x4	185
SSS 205G	20	5.0x 20.0	0.188	7	28.1	703	21.4	535	16.1	400	11--12	1x 36x4	265
SSS 254C	25	4.0x 25.0	0.125	11	4.8	150	2.6	100	1.0	110	8--9	3/4x 1Bx3	170
SSS 254G	25	4.0x 25.0	0.188	7	10.8	270	7.7	188	5.4	135	8--9	3/4x 30x3	245
SSS 255C	25	5.0x 25.0	0.125	11	9.8	245	6.3	157	3.7	100	10--12	1x 36x4	225
SSS 255G	25	5.0x 25.0	0.188	7	19.3	480	14.0	350	10.0	210	11--12	1x 36x4	225
SSS 305C	30	5.0x 30.0	0.125	11	4.7	150	2.0	80	--	--	10--12	1x 36x4	265
SSS 305G	30	5.0x 30.0	0.188	7	10.7	270	6.7	167	3.9	100	10--12	1x 36x4	300
SSS 30&G	30	6.0x 30.0	0.188	7	15.7	392	10.1	257	6.4	160	11--13	1x 36x4	520
SSS 355G	35	5.0x 35.0	0.188	7	5.9	150	2.5	100	--	--	10--12	1x 36x4	440
SSS 35 &G	35	6.0x 35.0	0.188	7	9.5	237	5.0	150	1.8	110	11--13	1x 36x4	540
SSS 396G	39	6.0x 39.0	0.188	7	5.1	128	1.3	33	--	--	11--13	1x 36x4	605

BASE DETAIL SSS 4" SHAFT

BASE DETAIL SSS 5" & 6" SHAFT

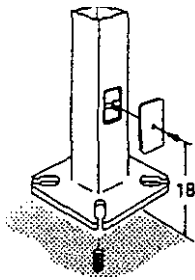
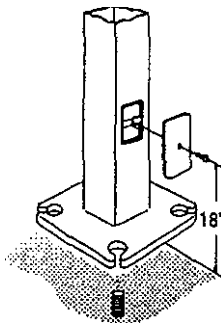

POLE OPTIONS

SUFFIX	DESCRIPTION
FOL	Festoon Outlet - less electrical
FGL	Festoon GFI Outlet - less electrical
HI 18S'	Horizontal Arm Bracket - 1 fixed, Jr &
VD	Vibration Damper(s) and 6" poles only)
VAB	Less Anchor Bolts
HH'	Extra Handhole

NOTES:

- Specify the orientation when ordering (based on orientation from handhole).
- Consult factory for more details concerning handhole outlet.
- Combination of Tenon-top and drill mount require extra handhole.

IMPORTANT:

- The specifications listed herein are for informational purposes only. Lithonia Lighting reserves the right to change specifications without prior notice. In continuation of our commitment to product quality.
- In the event of a discrepancy between the specifications and the product, the specifications shall prevail.

135-POLE

01994 Lithonia Lighting, Rev. 10197
135-POLE.PM8

LITHONIA LIGHTING

SPECIFICATION OUTDOOR LIGHTING

1815 EAST ELMORE STREET, CAARFORDS, ILLINOIS 61811-1117, FAX 382-1111
CANADA: 110050TH AVENUE, LACHINE, QUEBEC H3T 1A1, TEL 514-881-1111

MESSIAH COLLEGE COMMUNICATION STANDARDS

Including: Cable Infrastructure / Fiber / Wireless / Door Access

The following are the standards for telecommunications infrastructure unless changes are granted by the Communications Infrastructure Manager or the Director of Network Services.

Standards References

- EIA/TIA 568
- EIA/TIA 569
- EIA/TIA 942
- ETA – FIBER PLANT

Contents

Indoor Cable Infrastructure	2
Station Cables	2
• Wall jacks	2
• Wall Phones	2
• Pathways.....	3
Communication Rooms (MDF/IDF).....	3
Wireless Access Points.....	3
Indoor Fiber.....	3
Outdoor Infrastructure	4
Outdoor Copper Plant.....	4
Outdoor Fiber Plant	4
Conduit Banks	4
Door Access System	5
Inbuilding Cellular Systems	6

Indoor Cable Infrastructure

Station Cables

- Copper plant will use the Leviton Atlas system
- Cable plant will be Berktek category 6 blue in color or other cable certified by Leviton for use in a Leviton Atlas installation.
- Data and voice use the same infrastructure (cables, jacks, patch panels, termination)
- All cable lengths must be within standard distance specifications for Cat 6 at 100 meters
- Cables must be installed by certified Leviton installer and covered by Leviton warranties
- Cables must be tested and verified to pass Cat 6 specifications
- All network cabling in the project should be coordinated with the same installer using the same specifications. Any network cable requirements from audio/visual or other parties need to be merged with other network data needs to ensure a consistent installation for the entire project.
- **Wall jacks**
 - Duplex unless otherwise specified
 - Leviton Atlas jacks category 6 ivory jacks and inserts (unless alternate color specified)
 - Leviton ivory cover plates (unless alternate color specified)
 - Small offices can have 1 duplex jack if cable lengths to desk locations is within 12'. Mid size offices should have 2 duplex jacks on opposing walls to allow for flexible furniture placement. Larger or odd shaped spaces may require a 3rd duplex jack.
 - Classrooms and labs without specific network needs have number and locations of duplex jacks assigned by the college during the planning process.
 - All classrooms and labs should have a location specified for a wall mount phone unless specified otherwise for a particular space.
 - Jacks need placed to accommodate equipment such as copiers, card readers. Nooks where equipment could be placed or a small desk should have a jack nearby.
- **Wall Phones**
 - Single gang box with Leviton QuickPort wall phone plate (such as 4108W-1SP)
 - Cat 6 cable should be have RJ45 connector ready for IP phone connection
 - Cable should have 12" of length available to pull out of the box

- **Pathways**
 - 10" basket tray should be used when feasible; smaller size when appropriate and approved by the college
 - Basket tray needs to have appropriate clearance for accessibility after construction. This involves coordination with electrical, hvac, and other building systems.
 - Upon collect approval, "J" hooks may be used where basket tray is not feasible when a small number of cables are involved
 - When feasible, station cable will be run in conduit to the basket tray or direct to MDF/IDF

Communication Rooms (MDF/IDF)

- Leviton rack mounted category 6 Atlas insert patch panels
- Cables will all have a minimum 10' service loop at MDF/IDF
- Rack shall be B-Line or better with proper vertical and horizontal management
- Power should be generator supplied when a generator is available
- College will provide the following:
 - UPS
 - patch cables for connecting panels to network equipment
 - network switch equipment
- Layout of rack and labeling should be coordinated with Messiah Network Services during installation

Wireless Access Points

- Access points will be provided by the college to be physical installed by the contractor.
- Access Points require a single Cat 6 cable with a RJ45 connector at the AP.
- Ceiling Grid: Access points can either be clipped to ceiling grid when a compatible grid is available or mounted thru a ceiling panel using screws with a contractor provided backboard above the tile. Other mounting brackets could be used with college approval. There should be a 10' service loop at the AP to facilitate AP position location adjustments.
- Other ceiling or wall mounted: Locations require a single gang box for mounting of the AP
- Open Ceiling: AP must be mounted **BELOW** steel structures to allow proper signal propagation.
- Precise locations should be verified with Messiah Networking during installation

Indoor Fiber

- Strand count and fiber type to be determined by project and approved by Messiah Network Services. Sumitomo air blown when specified. Leviton or Siecor when traditional is specified.
- Terminations **must** use fusion spliced factory made pigtailed with **SC** connectors
- Single mode will have blue connectors while multimode will have ivory connectors

Outdoor Infrastructure

Outdoor Copper Plant

- AT&T or better lightning protection for 22 gauge wire
- Gel filled 22 gauge armored grounded
- Leviton category 6 lightning connectors for any outdoor category 6 cables

Outdoor Fiber Plant

- Sumitomo air blown, tube and strand counts to be specified by Messiah per project
- Terminations **must** use fusion spliced factory made pigtails with **SC** connectors
- 15' minimum service loop at each terminated end
- Tracer required if fiber is not in same conduit as copper
- Installer must be a certified Sumitomo installer

Conduit Banks

- 2 conduits 3" each, stacked to reduce width
- 10" stone dust over conduits with marking tape over the dust
- Minimum depth should be 30"

Door Access System

Door access is to be provided via the Blackboard Transact Door Access system so all electronics, power supplies, and door hardware must be compatible with this system. Due to policies with Blackboard, some equipment must be provided by the college while others can be provided by the contractor. The contractor will be responsible for all physical installation and wiring of the components while Messiah IT will provision and configure the access controllers.

The following guides are available for review in PDF format:

- SA3000 Door Access System Installation Guide
- Multiple SA3000DC Door Controller Installation

Equipment provided by the college:

- Master Controllers (SA3032) – 1 per 8 doors
- Door Controllers (SA3000DC) – 1 per door
- Controller enclosures and power supplies – 1 per 2 controllers (master or door)
- Card Readers with magstripe and contactless support – 1 per door

Equipment provided by contractor – everything else which includes:

- Door hardware and locks that are compatible with system
 - Door wiring via transfer tube and NOT hinge based (hinge wires break easy)
 - Exterior doors should include a Request-To-Exit switch. Interior doors should include if specified.
 - Doors should include a door position indicator to aid the system in the relock operation and to allow monitoring of held open doors. This requirement may be waived for certain interior doors if specified by the college.
 - Powered locks to be fail-open or fail-locked as specified by Messiah Facility Services
- Power supply needed for door lock as specified by Messiah Facility Services
- All wiring and power needed to implement the system

Other Notes:

- Door power supplies and electronics will be centrally located in the Telecom rooms and not positioned near door locations.

Inbuilding Cellular Systems

Notes for inbuilding Cellular if specified for a project:

- Messiah has current inbuilding cellular systems that should be extended. An alternate core system should not be proposed unless agreed upon by Messiah Network Services.
- The current system has been designed and supported by C Squared who has appropriate relationships and approvals for the equipment vendors and cellular carriers (**VERY IMPORTANT**). It is also possible that we will have carrier systems on campus.
- System design and installation should be coordinated with Messiah Network Services and C Squared. While another contractor can install antenna cable under the direction of C Squared, C Squared needs to install, test, and tune the electronics.
- It is possible that carriers such as Verizon will become involved in these projects as well which is why design and installation coordination with Messiah IT is critical.

**SECTION 240010
MAINTENANCE OF CAST-IN-PLACE CONCRETE**

PART 1 - GENERAL

1.1 SUMMARY

A. Section Includes:

1. Removal of deteriorated concrete and subsequent replacement and patching.
2. Floor joint repair.
3. Epoxy crack injection.
4. Corrosion-inhibiting treatment.
5. Composite structural reinforcement.

1.2 PRE-INSTALLATION MEETINGS

- A. Pre-installation Conference:** Conduct conference at Project site.

1.3 ACTION SUBMITTALS

- A. Product Data:** For each type of product. Include construction details, material descriptions, chemical composition, physical properties, test data, and mixing, preparation, and application instructions.
- B. Samples:** Cured samples for each exposed product and for each color and texture specified, in Manufacturer's standard size appropriate for each type of work.
- C. Samples for Verification:** Cured samples for each exposed product and for each color and texture specified.
1. Include Samples of each required type, color, and texture of patching material in the form of patches in drilled holes or sawed joints in sample concrete representative of the range of concrete colors on the building.

1.4 INFORMATIONAL SUBMITTALS

- A. Qualification Data:** For installers and Manufacturers.
- B. Material Certificates:** For each type of portland cement aggregate supplied for mixing or adding to products at Project site.
- C. Product Test Reports:** For each manufactured bonding agent, cementitious patching mortar, joint-filler, crack injection adhesive, composite structural reinforcement, for tests performed by Manufacturer and witnessed by a qualified testing agency.
- D. Field quality-control reports.**

- E. Maintenance Program: Submit before work begins.

1.5 QUALITY ASSURANCE

- A. Manufacturer Qualifications: Each manufactured bonding-agent, cementitious patching-mortar, joint-filler, crack-injection-adhesive, and composite-structural-reinforcement Manufacturer shall employ factory-trained technical representatives who are available for consultation and Project-site inspection and assistance at no additional cost.
- B. Installer Qualifications: An entity that employs installers and supervisors who are trained and approved by Manufacturer to apply packaged patching-mortar materials, epoxy crack injection materials, corrosion-inhibiting treatments, and composite structural reinforcement.
- C. Maintenance Program: Prepare a written plan for maintenance of cast-in-place concrete, including each phase or process, protection of surrounding materials during operations, and control of debris and runoff during the Work. Describe in detail materials, methods, equipment, and sequence of operations to be used for each phase of the Work.
- D. Mockups: Build mockups to demonstrate aesthetic effects and set quality standards for materials and execution.
 - 1. Deck Removal and Patching: Remove and repair an approximately 50 sq. ft. area of deteriorated concrete deck.
 - 2. Floor Joint Repair: Cut out and reinstall joints in two separate areas each approximately 48 inches long.
 - 3. Epoxy Crack Injection: Perform epoxy crack injection in two separate areas each approximately 48 inches long.
 - 4. Composite Structural Reinforcement: Apply composite structural reinforcement a minimum of 48 inches long.
 - 5. Subject to compliance with requirements, approved mockups may become part of the completed Work if undisturbed at time of Substantial Completion.

1.6 DELIVERY, STORAGE, AND HANDLING

- A. Comply with Manufacturer's written instructions for minimum and maximum temperature requirements and other conditions for storage.
- B. Store cementitious materials off the ground, under cover, and in a dry location.
- C. Store aggregates covered and in a dry location; maintain grading and other required characteristics and prevent contamination.

1.7 FIELD CONDITIONS

- A. Environmental Limitations for Epoxies: Do not apply when air and substrate temperatures are outside limits permitted by Manufacturer. During hot weather, cool epoxy components before mixing, store mixed products in shade, and cool unused mixed products to retard setting. Do not apply to wet substrates unless approved by Manufacturer.

1. Use only Class A epoxies when substrate temperatures are below or are expected to go below 40 deg F within 8 hours.
 2. Use only Class A or B epoxies when substrate temperatures are below or are expected to go below 60 deg F within 8 hours.
 3. Use only Class C epoxies when substrate temperatures are above and are expected to stay above 60 deg F for 8 hours.
- B. Cold-Weather Requirements for Cementitious Materials: Do not apply unless concrete-surface and air temperatures are above 40 deg F and will remain so for at least 48 hours after completion of Work.
- C. Hot-Weather Requirements for Cementitious Materials: Protect repair work when temperature and humidity conditions produce excessive evaporation of water from patching materials. Provide artificial shade and wind breaks, and use cooled materials as required. Do not apply to substrates with temperatures of 90 deg F and above.

PART 2 - PRODUCTS

2.1 MATERIALS, GENERAL

- A. Source Limitations: Obtain each color, grade, finish, type, and variety of product from single source with resources to provide products of consistent quality in appearance and physical properties.
- B. VOC Content: Provide materials that comply with VOC limits of authorities having jurisdiction.

2.2 BONDING AGENTS

- A. Epoxy-Modified, Cementitious Bonding and Anticorrosion Agent: Manufactured product that consists of water-insensitive epoxy adhesive, Portland cement, and water-based solution of corrosion-inhibiting chemicals that forms a protective film on steel reinforcement.
1. Products: Subject to compliance with requirements, available products that may be incorporated into the Work include, but are not limited to, the following:
 - a. BASF Construction Chemicals - Building Systems; Emaco P24.
 - b. Euclid Chemical Company (The), an RPM company; Duralprep A.C.
 - c. Kaufman Products, Inc.; Surepoxy HM EPL.
 - d. Sika Corporation, Construction Product Division; Arimatec 110 EpoCem.
 - e. Sto Corp., Concrete Restoration Division; Sto Bonding and Anti-Corrosion Agent.
- B. Epoxy Bonding Agent: ASTM C 881, Type II and free of VOCs.
1. Manufacturers: Subject to compliance with requirements, available Manufacturers offering products that may be incorporated into the Work include, but are not limited to, the following:
 - a. BASF Construction Chemicals - Building Systems.
 - b. ChemCo Systems.

- c. Dayton Superior Corporation.
- d. Euclid Chemical Company (The); an RPM company.
- e. Kaufman Products, Inc.
- f. Sika Corporation; Construction Product Division.
- g. Sto Corp., Concrete Restoration Division.
- h. Unitex.
- i. US SPEC; Division of US MIX Products Company.
- j. W. R. Meadows, Inc.

- C. Mortar Scrub Coat: Mix consisting of 1 part Portland cement and 1 part fine aggregate complying with ASTM C 144 except 100 percent passing a No. 16 sieve.

2.3 PATCHING MORTAR

A. Patching Mortar, General:

- 1. Only use patching mortars that are recommended by Manufacturer for each applicable horizontal, vertical, or overhead use orientation.
- 2. Color and Aggregate Texture: Provide patching mortar and aggregates of colors and sizes necessary to produce patching mortar that matches existing, adjacent, exposed concrete. Blend several aggregates if necessary to achieve suitable matches.
- 3. Coarse Aggregate for Patching Mortar: ASTM C 33, washed aggregate, Size No. 8, Class 5S. Add to patching-mortar mix only as permitted by patching-mortar Manufacturer.

- B. Job-Mixed Patching Mortar: 1 part Portland cement and 2-1/2 parts fine aggregate complying with ASTM C 144, except 100 percent passing a No. 16 sieve.

C. Cementitious Patching Mortar: Packaged, dry mix for repair of concrete.

- 1. Manufacturers: Subject to compliance with requirements, available Manufacturers offering products that may be incorporated into the Work include, but are not limited to, the following:
 - a. BASF Construction Chemicals - Building Systems.
 - b. CGM, Incorporated.
 - c. Dayton Superior Corporation.
 - d. Euclid Chemical Company (The); an RPM company.
 - e. Fox Industries, Inc.
 - f. Kaufman Products, Inc.
 - g. Sika Corporation; Construction Product Division.
 - h. Sto Corp.; Concrete Restoration Division.
 - i. Unitex.
 - j. US SPEC; Division of US MIX Products Company.
 - k. W. R. Meadows, Inc.
- 2. Compressive Strength: Not less than 5000 psi at 28 days when tested according to ASTM C 109/C 109M.

2.4 PREPLACED CONCRETE MATERIALS

- A. Preplaced Aggregate: Washed aggregate, ASTM C 33, Class 5S, with 95 to 100 percent passing a 1-1/2-inch sieve, 40 to 80 percent passing a 1-inch sieve, 20 to 45 percent passing a 3/4-inch sieve, 0 to 10 percent passing a 1/2-inch sieve, and 0 to 2 percent passing a 3/8-inch.
- B. Fine Aggregate for Grout: Fine aggregate according to ASTM C 33, but with 100 percent passing a No. 8 sieve, 95 to 100 percent passing a No. 16 sieve, 55 to 80 percent passing a No. 30 sieve, 30 to 55 percent passing a No. 50 sieve, 10 to 30 percent passing a No. 100 sieve, 0 to 10 percent passing a No. 200 sieve, and having a fineness modulus of 1.30 to 2.10.
- C. Grout Fluidifier for Grout: ASTM C 937.
- D. Pozzolans for Grout: ASTM C 618.

2.5 JOINT FILLER

- A. Polyurea Joint Filler: Two-component, semirigid, 100 percent solids, polyurea resin with a Type A Shore durometer hardness of at least 80 according to ASTM D 2240.
 - 1. Products: Subject to compliance with requirements, [provide the following] [provide one of the following] [available products that may be incorporated into the Work include, but are not limited to, the following]:
 - a. ASTC Polymers; Penetron 3003.
 - b. BASF Construction Chemicals - Building Systems; Masterfill 400 CT.
 - c. ChemCo Systems; CCS Grout, Polyurea SWL.
 - d. Dayton Superior Corporation; Joint Fill.
 - e. Euclid Chemical Company (The), an RPM company; Euco Qwikjoint 200.
 - f. Metzger/McGuire; Spal-Pro 2000.
- B. Color: As **selected by Owner** from full range of industry colors.

2.6 EPOXY CRACK-INJECTION MATERIALS

- A. Epoxy Crack-Injection Adhesive: ASTM C 881/C 881M, Type IV at structural locations and Type I at other locations; free of VOCs.
 - 1. Manufacturers: Subject to compliance with requirements, available Manufacturers offering products that may be incorporated into the Work include, but are not limited to, the following:
 - a. BASF Construction Chemicals - Building Systems.
 - b. ChemCo Systems.
 - c. Dayton Superior Corporation.
 - d. Euclid Chemical Company (The); an RPM company.
 - e. Kaufman Products, Inc.
 - f. Sika Corporation; Construction Product Division.
 - g. Sto Corp.; Concrete Restoration Division.

- h. Unitex.
 - i. US SPEC; Division of US MIX Products Company.
 - j. W. R. Meadows, Inc.
2. Capping Adhesive: Product manufactured for use with crack injection adhesive by same Manufacturer.
 3. Color: Provide epoxy crack-injection adhesive and capping adhesive.

2.7 OTHER MATERIALS

- A. Corrosion-Inhibiting Treatment: Waterborne solution of alkaline corrosion-inhibiting chemicals for concrete-surface application that penetrates concrete by diffusion and forms a protective film on steel reinforcement.
 1. Products: Subject to compliance with requirements, available products that may be incorporated into the Work include, but are not limited to, the following:
 - a. Cortec Corporation; MCI 2020 Series.
 - b. Euclid Chemical Company (The), an RPM company; Duralprep 3020.
 - c. Evonik Degussa Corporation; Protectosil CIT.
 - d. Fox industries, Inc.; FX-361 Migratory Corrosion Inhibitor.
 - e. Sika Corporation, Construction Product Division; Sika FerroGard 903.
 - f. Sto Corp., Concrete Restoration Division; Sto Migratory Corrosion Inhibitor CR247.
- B. Composite Structural Reinforcement: Manufacturer's system consisting of glass fiber reinforcement in the form of pre-impregnated sheet and epoxy primers, fillers, adhesives, saturants, and topcoats, designed for use as externally bonded structural reinforcement for concrete.
 1. Products: Subject to compliance with requirements, available products that may be incorporated into the Work include, but are not limited to, the following:
 - a. BASF Construction Chemicals - Building Systems; S&P Laminate.
 - b. Sika Corporation, Construction Product Division; SikaWrap.
 - c. VSL (VStructural, LLC), a Structural Group company; V-Wrap EG50.
- C. Portland Cement: ASTM C 150, Type I, II, or III unless otherwise indicated.

2.8 MIXES

- A. General: Mix products, in clean containers, according to Manufacturer's written instructions.
 1. Do not add water, thinners, or additives unless recommended by Manufacturer.
 2. When practical, use Manufacturer's premeasured packages to ensure that materials are mixed in proper proportions. When premeasured packages are not used, measure ingredients using graduated measuring containers; do not estimate quantities or use shovel or trowel as unit of measure.

3. Do not mix more materials than can be used within time limits recommended by Manufacturer. Discard materials that have begun to set.
- B. Mortar Scrub Coat: Mix dry ingredients with enough water to provide consistency of thick cream.
- C. Dry-Pack Mortar: Mix patching-mortar dry ingredients with just enough liquid to form damp cohesive mixture that can be squeezed by hand into a ball but is not plastic.
- D. Concrete: Comply with Section 033000 "Cast-in-Place Concrete".
- E. Grout for Use with Pre-placed Aggregate: Proportion according to ASTM C 938. Add grout fluidifier to mixing water followed by Portland cement, pozzolan, and fine aggregate.

PART 3 - EXECUTION

3.1 EXAMINATION

- A. Notify Owner seven days in advance of dates when areas of deteriorated or delaminated concrete and deteriorated reinforcing bars will be located.
- B. Locate areas of deteriorated or delaminated concrete using hammer or chain-drag sounding and mark boundaries. Mark areas for removal by simplifying and squaring off boundaries. At columns and walls make boundaries level and plumb unless otherwise indicated.
- C. Pachometer Testing: Locate at least three reinforcing bars using a pachometer, and drill test holes to determine depth of cover. Calibrate pachometer using depth of cover measurements, and verify depth of cover in removal areas using pachometer.
- D. Perform surveys as the Work progresses to detect hazards resulting from concrete-maintenance work.

3.2 PREPARATION

- A. Ensure that supervisory personnel are on-site and on duty when concrete maintenance work begins and during its progress.
- B. Preparation for Removal of Deteriorated Concrete: Examine construction to be repaired to determine best methods to safely and effectively perform concrete maintenance work. Examine adjacent work to determine what protective measures will be necessary. Make explorations, probes, and inquiries as necessary to determine condition of construction to be removed in the course of repair.
 1. Verify that affected utilities have been disconnected and capped.
 2. Inventory and record the condition of items to be removed for reinstallation or salvage.
 3. Provide and maintain shoring, bracing, and temporary structural supports as required to preserve stability and prevent unexpected or uncontrolled movement, settlement, or collapse of construction being demolished and construction and finishes to remain.

- C. Protect persons, motor vehicles, surrounding surfaces of building being restored, building site, plants, and surrounding buildings from harm resulting from concrete maintenance work.
1. Comply with each product Manufacturer's written instructions for protections and precautions. Protect against adverse effects of products and procedures on people and adjacent materials, components, and vegetation.
 2. Use only proven protection methods appropriate to each area and surface being protected.
 3. Provide barricades, barriers, and temporary directional signage to exclude public from areas where concrete maintenance work is being performed.
 4. Erect temporary protective covers over walkways and at points of pedestrian and vehicular entrance and exit that must remain in service during course of concrete maintenance work.
 5. Contain dust and debris generated by concrete maintenance work and prevent it from reaching the public or adjacent surfaces.
 6. Use water-mist sprinkling and other wet methods to control dust only with adequate, approved procedures and equipment that ensure that such water will not create a hazard or adversely affect other building areas or materials.
 7. Protect floors and other surfaces along haul routes from damage, wear, and staining.
 8. Provide supplemental sound-control treatment to isolate removal and dismantling work from other areas of the building.
 9. Protect adjacent surfaces and equipment by covering them with heavy polyethylene film and waterproof masking tape or a liquid strippable masking agent. If practical, remove items, store, and reinstall after potentially damaging operations are complete.
 10. Neutralize and collect alkaline and acid wastes for disposal off Owner's property.
 11. Dispose of debris and runoff from operations by legal means and in a manner that prevents soil erosion, undermining of paving and foundations, damage to landscaping, and water penetration into building interiors.
- D. Existing Drains: Prior to the start of work in an area, test drainage system to ensure that it is functioning properly. Notify Owner immediately of inadequate drainage or blockage. Do not begin work in an area until the drainage system is in working order.
1. Prevent solids such as aggregate or mortar residue from entering the drainage system. Clean out drains and drain lines that become sluggish or blocked by sand or other materials resulting from concrete maintenance work.
 2. Protect drains from pollutants. Block drains or filter out sediments, allowing only clean water to pass.
- E. Concrete Removal:
1. Provide shoring, bracing, and supports as necessary. Strengthen or add new supports when required during progress of removal work. Do not overload structural elements with debris.
 2. Saw-cut perimeter of areas indicated for removal to a depth of at least 1/2 inch. Make cuts perpendicular to concrete surfaces and no deeper than cover on reinforcement.
 3. Remove deteriorated and delaminated concrete by breaking up and dislodging from reinforcement.
 4. Remove additional concrete if necessary to provide a depth of removal of at least 1/2 inch over entire removal area.
 5. Where half or more of the perimeter of reinforcing bar is exposed, bond between reinforcing bar and surrounding concrete is broken, or reinforcing bar is corroded,

remove concrete from entire perimeter of bar and to provide at least a 3/4-inch clearance around bar.

6. Test areas where concrete has been removed by tapping with hammer, and remove additional concrete until unsound and disbonded concrete is completely removed.
7. Provide surfaces with a fractured profile of at least 1/8 inch that are approximately perpendicular or parallel to original concrete surfaces. At columns and walls, make top and bottom surfaces level unless otherwise directed.
8. Thoroughly clean removal areas of loose concrete, dust, and debris.

F. Reinforcing-Bar Preparation: Remove loose and flaking rust from reinforcing bars by high-pressure water cleaning until only tightly adhered light rust remains.

1. Where section loss of reinforcing bar is more than 25 percent, or 20 percent in two or more adjacent bars, cut bars and remove and replace. Remove additional concrete as necessary to provide at least 3/4-inch clearance at existing and replacement bars. Splice replacement bars to existing bars according to ACI 318 by lapping, welding, or using mechanical couplings.

G. Preparation of Floor Joints for Repair: Saw-cut joints full width to edges and depth of spalls, but not less than 1 inch deep. Clean out debris and loose concrete; vacuum or blow clear with compressed air.

H. Surface Preparation for Corrosion-Inhibiting Treatment: Clean concrete to remove dirt, oils, films, and other materials detrimental to treatment application.

1. Use low-pressure water cleaning.
2. Allow surface to dry before applying corrosion-inhibiting treatment.

I. Surface Preparation for Composite Structural Reinforcement: Clean concrete where reinforcement and epoxy patching mortar is to be placed by low-pressure water cleaning to remove dirt, oils, films, and other materials detrimental to epoxy patching mortar.

1. Roughen surface of concrete by sand blasting.
2. Remove delaminated material and deteriorated concrete surface material.
3. Sweep and vacuum roughened surface to remove debris followed by low-pressure water cleaning.

3.3 APPLICATION

A. General: Comply with Manufacturer's written instructions and recommendations for application of products, including surface preparation.

B. Epoxy-Modified, Cementitious Bonding and Anticorrosion Agent: Apply to reinforcing bars and concrete by stiff brush or hopper spray according to Manufacturer's written instructions. Apply to reinforcing bars in two coats, allowing first coat to dry two to three hours before applying second coat. Allow to dry before placing patching mortar or concrete.

C. Epoxy Bonding Agent: Apply to reinforcing bars and concrete by brush, roller, or spray according to Manufacturer's written instructions, leaving no pinholes or other uncoated areas. Apply to reinforcing bars in at least two coats, allowing first coat to dry before applying second

coat. Place patching mortar or concrete while epoxy is still tacky. If epoxy dries, recoat before placing patching mortar or concrete.

- D. Mortar Scrub Coat for Job-Mixed Patching Mortar and Concrete: Dampen repair area and surrounding concrete 6 inches beyond repair area. Remove standing water and apply scrub coat with a brush, scrubbing it into surface and thoroughly coating repair area. If scrub coat dries, recoat before placing patching mortar or concrete.
- E. Slurry Coat for Cementitious Patching Mortar: Wet substrate thoroughly and then remove standing water. Scrub a slurry of neat patching mortar mixed with latex bonding agent into substrate, filling pores and voids.
- F. Placing Patching Mortar: Place as follows unless otherwise recommended in writing by Manufacturer:
 - 1. Provide forms where necessary to confine patch to required shape.
 - 2. Wet substrate and forms thoroughly and then remove standing water.
 - 3. Pre-treatment: Apply specified bonding agent.
 - 4. General Placement: Place patching mortar by troweling toward edges of patch to force intimate contact with edge surfaces. For large patches, fill edges first and then work toward center, always troweling toward edges of patch. At fully exposed reinforcing bars, force patching mortar to fill space behind bars by compacting with trowel from sides of bars.
 - 5. Vertical Patching: Place material in lifts of not more than 1 inch nor less than 1/8 inch. Do not feather edge.
 - 6. Overhead Patching: Place material in lifts of not more than 1 inch nor less than 1/8 inch. Do not feather edge.
 - 7. Consolidation: After each lift is placed, consolidate material and screed surface.
 - 8. Multiple Lifts: Where multiple lifts are used, score surface of lifts to provide a rough surface for placing subsequent lifts. Allow each lift to reach final set before placing subsequent lifts.
 - 9. Finishing: Allow surfaces of lifts that are to remain exposed to become firm and then finish to a surface matching adjacent concrete.
 - 10. Curing: Wet-cure cementitious patching materials, including polymer-modified cementitious patching materials, for not less than seven days by water-fog spray or water-saturated absorptive cover.
- G. Dry-Pack Mortar: Use for deep cavities. Place as follows unless otherwise recommended in writing by Manufacturer:
 - 1. Provide forms where necessary to confine patch to required shape.
 - 2. Wet substrate and forms thoroughly and then remove standing water.
 - 3. Pretreatment: Apply specified bonding agent.
 - 4. Place dry-pack mortar into cavity by hand, and compact tightly into place. Do not place more material at a time than can be properly compacted. Continue placing and compacting until patch is approximately level with surrounding surface.
 - 5. After cavity is filled and patch is compacted, trowel surface to match profile and finish of surrounding concrete. A thin coat of patching mortar may be troweled into the surface of patch to help obtain required finish.
 - 6. Wet-cure patch for not less than seven days by water-fog spray or water-saturated absorptive cover.

H. Concrete: Place according to Section 240020 "Cast-in-Place Concrete" and as follows:

1. Pre-treatment: Apply epoxy bonding agent to reinforcement and concrete substrate.
2. Standard Placement:
 - a. Use vibrators to consolidate concrete as it is placed.
 - b. At unformed surfaces, screed concrete to produce a surface that when finished with patching mortar will match required profile and surrounding concrete.
3. Form-and-Pump Placement: Place concrete by form and pump method.
 - a. Design and construct forms to resist pumping pressure in addition to weight of wet concrete. Seal joints and seams in forms and where forms abut existing concrete.
 - b. Pump concrete into place from bottom to top, releasing air from forms as concrete is introduced. When formed space is full, close air vents and pressurize to 14 psi.
4. Wet-cure concrete for not less than seven days by leaving forms in place or keeping surfaces continuously wet by water-fog spray or water-saturated absorptive cover.
5. Fill placement cavities with dry-pack mortar and repair voids with patching mortar. Finish to match surrounding concrete.

I. Grouted Preplaced Aggregate Concrete: Use for column and wall repairs. Place as follows:

1. Design and construct forms to resist pumping pressure in addition to weight of wet grout. Seal joints and seams in forms and where forms abut existing concrete.
2. Apply epoxy bonding agent to reinforcement and concrete substrate.
3. Place aggregate in forms, consolidating aggregate in lifts as it is placed. Pack aggregate into upper areas of forms to achieve intimate contact with concrete surfaces.
4. Fill forms with water to thoroughly dampen aggregate and substrates. Drain water from forms before placing grout.
5. Pump grout into place at bottom of preplaced aggregate, forcing grout upward. Release air from forms at top as grout is introduced. When formed space is full and grout flows from air vents, close vents and pressurize to 14 psi.
6. Wet-cure concrete for not less than seven days by leaving forms in place or keeping surfaces continuously wet by water-fog spray or water-saturated absorptive cover.
7. Repair voids with patching mortar and finish to match surrounding concrete.

J. Floor-Joint Repair: Cut out deteriorated concrete and reconstruct sides of joint with patching mortar. Install joint filler in nonmoving floor joints where indicated and as follows:

1. Depth: Install joint filler to a depth of at least 1 inch. Use fine silica sand no more than 1/4-inch-deep to close base of joint. Do not use sealant backer rods or compressible fillers below joint filler.
2. Top Surface: Install joint filler so that when cured, it is flush at top surface of adjacent concrete. If necessary, overfill joint and remove excess when filler has cured.

K. Epoxy Crack Injection:

1. Clean areas to receive capping adhesive of oil, dirt, and other substances that would interfere with bond, and clean cracks with oil-free compressed air or low-pressure water to remove loose particles.

2. Place injection ports as recommended by epoxy Manufacturer, spacing no farther apart than thickness of member being injected. Seal injection ports in place with capping adhesive.
 3. Seal cracks at exposed surfaces with a ribbon of capping adhesive at least 1/4-inch-thick by 1 inch wider than crack.
 4. Inject cracks wider than 0.003 inch to a depth of 8 inches.
 5. Inject epoxy adhesive, beginning at widest part of crack and working toward narrower parts. Inject adhesive into ports to refusal, capping adjacent ports when they extrude epoxy. Cap injected ports and inject through adjacent ports until crack is filled.
 6. After epoxy adhesive has set, remove injection ports and grind surfaces smooth.
- L. Corrosion-Inhibiting Treatment: Apply by brush, roller, or airless spray in two coats at Manufacturer's recommended application rate. Remove film of excess treatment by high-pressure washing before patching treated concrete.
- M. Composite Structural Reinforcement Using Pre-impregnated Fiber Sheet: Unless otherwise recommended by Manufacturer, install as follows:
1. Patch surface defects with epoxy mortar and allow to set before beginning reinforcement application.
 2. Apply epoxy adhesive to a thickness of 1/16 inch to prepared concrete surfaces.
 3. Clean fiber sheet with acetone or other suitable solvent, and apply epoxy adhesive to a thickness of 1/16 inch.
 4. Apply adhesive-coated fiber sheet to adhesive-coated concrete and roll with a hard rubber roller until fiber sheet is fully embedded in adhesive, air pockets are removed, and adhesive is forced out from beneath fiber sheet at edges.
 5. Apply additional layers using same procedure.

3.4 FIELD QUALITY CONTROL

- A. Testing Agency: **Owner will engage** a qualified testing agency to perform tests and inspections.
- B. Perform the following tests and inspections:
1. Packaged, Cementitious Patching Mortar: Randomly selected sets of samples for each type of mortar required, tested according to ASTM C 928.
 2. Job-Mixed Patching Mortar: Randomly selected sets of samples for each type of mortar required, tested for compressive strength according to ASTM C 109/C 109M.
 3. Concrete: As specified in Section 033000 "Cast-in-Place Concrete".
 4. Grouted Preplaced Aggregate: Tested for compressive strength of grout according to ASTM C 942.
 - a. Testing Frequency: One sample for each 25 cu. yd. of grout or fraction thereof, but not less than one sample for each day's work.
 5. Joint Filler: Core-drilled samples to verify proper installation.
 - a. Testing Frequency: One sample for each 100 feet of joint filled.
 - b. Where samples are taken, refill holes with joint filler.

6. Epoxy Crack Injection: Core-drilled samples to verify proper installation.
 - a. Testing Frequency: 3 samples from mockup and 1 sample for each 100 feet of crack injected.
 - b. Where samples are taken, refill holes with epoxy mortar.
- C. Product will be considered defective if it does not pass tests and inspections.
- D. Prepare test and inspection reports.

** END OF SECTION **

SECTION 240020 CAST-IN-PLACE CONCRETE

PART 1 - GENERAL

1.1 SUMMARY

- A. Included: This Section includes cast-in-place concrete, including formwork, reinforcement, concrete materials, mixture design, placement procedures, and finishes, for the following:
1. Footings.
 2. Foundation walls.
 3. Slabs-on-grade.
 4. Embedded channels.
 5. Suspended slabs.
 6. Slip resistant stair nosings.
 7. Concrete toppings.
 8. Building walls.
 9. Receiving and installing inserts, anchors and like items to be embedded in cast-in-place concrete for other work.
 10. Normal weight structural concrete.
 11. Concrete finishing.
- B. Related Sections:
1. Section 240010 "Maintenance of Cast-in-Place Concrete" for repairing concrete slabs.
 2. Section 241080 "Joint Sealants" for joints in concrete.
 3. Section 280020 "Earth Moving" for drainage fill under slabs-on-grade.
 4. Section 282010 "Concrete Paving" for concrete pavement and walks.

1.2 DEFINITIONS

- A. Cementitious Materials: Portland cement alone or in combination with one or more of the following: blended hydraulic cement, fly ash and other pozzolans, ground granulated blast-furnace slag, and silica fume; subject to compliance with requirements.

1.3 PERFORMANCE REQUIREMENTS

- A. Codes and Standards: Meet requirements of codes and regulations of public authorities having jurisdiction over the Work:
1. ACI 117 Standard Specifications for Tolerances for Concrete Construction and Materials, including Commentary.
 2. ACI 211.1 Standard Practice for Selecting Proportions for Normal, Heavyweight and Mass Concrete.
 3. ACI 211.2 Standard Practice for Selecting Proportions for Structural Lightweight Concrete.

4. ACI 212.1R Admixtures for Concrete.
5. ACI 301 Specifications for Structural Concrete for Buildings.
6. ACI 302.1R Guide for Concrete Floor and Slab Construction.
7. ACI 304R Recommended Practice for Measuring, Mixing, Transporting and Placing Concrete.
8. ACI 305R Hot Weather Concreting.
9. ACI 306R Cold Weather Concreting.
10. ACI 308 Standard Practice for Curing Concrete.
11. ACI 309 Standard Practice for Consolidation of Concrete.
12. ACI 315 Details and Detailing of Concrete Reinforcement.
13. ACI 318 Building Code Requirements for Structural Concrete, including Commentary.
14. ACI 347R Recommended Practice for Concrete Formwork.
15. ACI 360R Design of Slabs on Grade.
16. ASTM C1077 Standard Practice for Laboratories Testing Concrete and Concrete Aggregates for Use in Construction and Criteria for Laboratory Evaluation, as applicable for work to be performed.
17. AWS D1.4 Structural Welding Code - Reinforcing Steel.
18. CRSI Manual of Standard Practice.
19. CRSI Placing Reinforcing Bars.

1.4 QUALITY ASSURANCE

- A. **Installer Qualifications:** A qualified installer who employs on Project personnel qualified as ACI-certified Flatwork Technician and Finisher and a supervisor who is an ACI-certified Concrete Flatwork Technician.
- B. **Manufacturer Qualifications:** A firm experienced in manufacturing ready-mixed concrete products and that complies with ASTM C 94 requirements for production facilities and equipment.
 1. Manufacturer certified according to NRMCA's "Certification of Ready Mixed Concrete Production Facilities."
- C. **Testing Agency Qualifications:** An independent agency, acceptable to authorities having jurisdiction, qualified according to ASTM C 1077 and ASTM E 329 for testing indicated.
 1. Personnel conducting field tests shall be qualified as ACI Concrete Field Testing Technician, Grade 1, according to ACI CP-1 or an equivalent certification program.
 2. Personnel performing laboratory tests shall be ACI-certified Concrete Strength Testing Technician and Concrete Laboratory Testing Technician - Grade I. Testing Agency laboratory supervisor shall be an ACI-certified Concrete Laboratory Testing Technician - Grade II.
- D. **Source Limitations:** Obtain each type or class of cementitious material of the same brand from the same Manufacturer's plant, obtain aggregate from single source, and obtain admixtures from single source from single Manufacturer.
- E. **Product Qualifications:**

1. Reinforcing Steel: Reinforcing steel shall be manufactured in the United States of America.
 2. Exposed Concrete: Concrete to be exposed to view in the completed work, including cement, aggregates and other ingredients, shall be of one mix design and each ingredient furnished from a single source.
- F. Engineer of Contractor Qualifications: Professional Engineer of Contractor licensed to practice as a structural engineer in jurisdiction where the work is located and experienced in providing structural engineering services that have resulted in successful installation and performance of work similar in extent, design and products to that required for the work.
- G. Welding Qualifications:
1. General: Prior to commencement of welding operations, qualify welding procedures and personnel to be employed on fabrication and installation work meeting requirements of AWS D1.4.
 2. Personnel: Qualifications shall remain in effect for duration of work, unless there is reason on part of Quality Control Service to question ability of welding personnel. Verification of qualifications of welding personnel required for work shall be performed by Quality Control Service at expense of Contractor, at no addition to Contract Sum.
- H. Flatwork Finishing Qualifications: Concrete flatwork finishing operations shall be overseen during entire process by a registered ACI flatwork finisher.
- I. ACI Publications: Comply with the following:
1. ACI 301 "Specifications for Structural Concrete," Sections 1 through 5.
 2. ACI 117 "Specifications for Tolerances for Concrete Construction and Materials."
- J. Concrete Testing Service: **Owner to Engage** a qualified independent testing agency to perform material evaluation, on-site testing for compressive strength, and concrete design mixes.
- K. Mockups: Cast concrete slab-on-grade and formed-surface panels to demonstrate typical joints, surface finish, texture, tolerances, vapor retarder, admixtures, floor treatments including dry shake hardener, curing and sealing materials, reinforcing, accessories, and standard of workmanship.
1. Build panel approximately 200 sq. ft. for slab-on-grade and 100 sq. ft. for formed surface in the location indicated.
 2. Approved mockups may become part of the completed Work if undisturbed at time of Substantial Completion.
- L. Pre-installation Conference: Conduct conference at Project site.
1. Before submitting design mixtures, review concrete design mixture and examine procedures for ensuring quality of concrete materials. Require representatives of each entity directly concerned with cast-in-place concrete to attend, including the following:
 - a. Contractor's superintendent.

- b. Independent testing agency.
 - c. Ready-mix concrete Manufacturer.
 - d. Concrete subcontractor.
 - e. Special concrete finish subcontractor.
 - f. Curing and Sealing materials Manufacturer's representative.
2. Review special inspection and testing and inspecting agency procedures for field quality control, concrete finishes and finishing, cold and hot weather concreting procedures, curing procedures, construction contraction and isolation joints, and joint filler strips, semi-rigid joint fillers, forms and form removal limitations, shoring and re-shoring procedures, vapor-retarder installation, anchor rod and anchorage device installation tolerances, steel reinforcement installation, floor and slab flatness and levelness measurement, concrete repair procedures, and concrete protection.

1.5 SOURCE QUALITY CONTROL

- A. General: Quality Control Service to perform pre-construction quality assurance and control evaluations of work to verify compliance of work with requirements of Contract Documents and of codes and regulations of public authorities having jurisdiction over the Work. As a minimum, Owner may invoke relevant provisions of the latest edition of the International Building Code.

1.6 ACTION SUBMITTALS

- A. Product Data: Submit product specifications, technical data and installation instructions of Manufacturer for each type of product indicated. Include published data, certified conformance report or certified laboratory test report of Manufacturer.
- B. Design Mixtures: For each concrete mixture. Submit alternate design mixtures when characteristics of materials, Project conditions, weather, test results, or other circumstances warrant adjustments.
 - 1. Indicate amounts of mixing water to be withheld for later addition at Project site.
 - 2. Provide compressive strength documentation in accordance with ACI requirements.
- C. Mill Certificates: Submit certified mill tests of reinforcing steel Manufacturer, indicating proof of compliance with applicable ASTM standard.
- D. Shop Drawings: Submit shop drawings for fabrication and installation of work. Include details and requirements for following and other pertinent data:
 - 1. Reinforcement:
 - a. Detail concrete reinforcement and accessories meeting requirements of ACI 315, ACI 318 and CRSI - Manual of Standard Practice.
 - b. Shop drawings shall be prepared under direction of engineer of Contractor.
 - c. Detailed drawings, sections and dimensions necessary for fabrication, bending, and placement of reinforcement including, but not limited to:

- 1) Bar types, sizes, lengths, locations, quantities, material, grade, bar schedules, stirrup spacing, bent bar diagrams, bar arrangement, splices and laps, mechanical connections, tie spacing, hoop spacing, and supports for concrete reinforcement.
 - 2) Reinforcing bar bending details, bending and cutting schedules (bar lists).
 - 3) Reinforcing bar hairpin anchors for inserts, anchors and like items to be embedded in concrete.
- E. Construction Joint Layout: Indicate proposed construction joints required to construct the structure.
- F. Samples:
1. General: Submit samples for vapor retarder and other materials.

1.7 INFORMATIONAL SUBMITTALS

- A. Welding Qualifications: Submit qualifications for welding procedures and personnel. Include qualification test records. Indicate any limitations to qualifications. Submittals will be only for information.
- B. Material Compliance: Submit the following:
1. Concrete:
 - a. Test reports for proposed concreting materials.
 - b. Proposed mix design for each class and type of concrete to be used in work and indicating where each mix design is to be placed in the work. Form of mix design submittal shall be acceptable to Owner.
 - c. Gradation of aggregates for each class and type concrete to be used in work.
 - d. Concrete enhanced with high-range water-reducing admixtures.
 - 1) Product data of admixture Manufacturer.
 - 2) Establish slump range and slump review procedures.
 2. Deformed Bar Concrete Reinforcement: Material compliance certificate and mill certificate of steel Manufacturer indicating compliance with applicable ASTM standards, including chemical and physical properties, tensile strength and bend test.
 3. Flatwork Finishing Procedures: Proposed procedures for each type concrete flatwork finish.
 4. Changes: Requested changes to concreting materials or concrete mix designs during course of work.
- C. Material Certificates: For each of the following, signed by Manufacturers:
1. Cementitious materials.
 2. Admixtures.
 3. Form materials and form-release agents.

4. Steel reinforcement and accessories.
5. Fiber reinforcement.
6. Waterstops.
7. Curing compounds.
8. Sealing materials.
9. Evaporation reducer liquids.
10. Floor and slab treatments.
11. Bonding agents.
12. Adhesives.
13. Vapor retarders.
14. Semi-rigid joint filler.
15. Non-slip floor treatments.
16. Structural non-shrink grout.
17. Joint-filler strips.
18. Repair materials.
19. Accessories.

- D. Floor surface flatness and levelness measurements indicating compliance with specified tolerances.
- E. Field quality-control reports.

1.8 PRODUCT HANDLING

A. General:

1. Meet requirements of ACI 304.
2. Do not use material that has deteriorated or has been contaminated.

- B. Carton Forms: Deliver carton forms in packaging of Manufacturer complete with installation instructions. Store off ground in ventilated and protected manner to prevent deterioration.

C. Steel Reinforcement:

1. Deliver, store, and handle steel reinforcement to prevent bending and damage. Avoid damaging coatings on steel reinforcement.
2. Store reinforcement off ground on suitable blocking and prevent accumulation of mud, dirt and other foreign material.
3. Epoxy Coated Reinforcement: Handling techniques for epoxy coated reinforcement shall meet requirements of ASTM D3963 and recommendations of CRSI.

- D. Waterstops: Store waterstops under cover to protect from moisture, sunlight, dirt, oil, and other contaminants.

- E. Welding Electrodes: Store and maintain welding electrodes meeting requirements of AWS D1.4.

- F. Cements: Store in weather tight buildings, bins or silos which provide protection from dampness and contamination and minimize warehouse set.

G. Aggregates:

1. Arrange stockpiles to avoid excessive segregation or contamination with other materials or with other sizes of aggregates.
2. Build stockpiles in successive horizontal layers not exceeding 3 feet in thickness, with each layer being completed before next is started.
3. Perform tests for conformance to requirements for cleanliness and grading from samples secured from aggregates at point of batching.
4. Do not use frozen or partially frozen aggregates.
5. Unless pre-damping is not considered desirable by Manufacturer, uniformly pre-dampen dry lightweight aggregates with water spray. Allow pre-dampened aggregates to remain in stockpiles for 12 hours minimum before use.

H. Admixtures:

1. Store powdered admixtures in same manner as cements, specified in this Section.
2. Store liquid admixtures in watertight containers and protect from freezing and temperature changes.
3. Meet requirements of ACI 212.

1.9 PROJECT CONDITIONS

A. Protection:

1. Unless adequate protection is provided, do not place concrete during precipitation events such as, but not limited to, drizzle, rain, sleet, snow, hail, and high winds or like weather, which may create environmental or climatic conditions that can adversely affect the design strength or appearance of concrete.
2. Do not allow rain water to increase mixing water, or damage or deface surface finish.

1.10 WARRANTY

A. Slabs-On-Grade:

1. Time Period: Extend warranty time period to **3 years**, minimum.

PART 2 - PRODUCTS

2.1 FORM MATERIALS

A. Form Facings: Meet requirements of ACI 347 and following:

1. Form facing material shall produce a smooth, hard, uniform texture on concrete.
2. Use plywood, tempered concrete form grade hardboard, metal, plastic or other material capable of producing required finish.
3. Form facing shall not have raised grain, torn surfaces, worn edges, patches, dents or other defects which will impair texture of final concrete surface.

- B. Form Liners: Wood, plastic, fiberglass or elastomeric liners which impart texture to concrete as accepted by Owner.
- C. Smooth-Formed Finished Concrete: Form-facing panels that will provide continuous, true, and smooth concrete surfaces. Furnish in largest practicable sizes to minimize number of joints.
 - 1. Plywood, metal, or other approved panel materials.
 - 2. Exterior-grade plywood panels, suitable for concrete forms, complying with DOC PS 1, and as follows:
 - a. High-density overlay, Class 1 or better.
 - b. Medium-density overlay, Class 1 or better; mill-release agent treated and edge sealed.
 - c. Structural 1, B-B or better; mill oiled and edge sealed.
 - d. B-B (Concrete Form), Class 1 or better; mill oiled and edge sealed.
- D. Pan Form Units:
 - 1. Well fitting, undamaged, factory fabricated units true to required cross-section; free from irregularities, dents, sags and other deformations. Provide splayed units adjacent to beams, girders and walls.
 - 2. Pan form materials:
 - a. Steel, 16 gage minimum, free from rust.
 - b. Fiberglass reinforced plastic.
- E. Rough Formed Finished Concrete: Plywood, lumber, metal, or another approved material. Provide lumber dressed on at least two edges and one side for tight fit.
- F. Forms for Cylindrical Columns, Pedestals, and Supports: Metal, glass-fiber-reinforced plastic, paper, or fiber tubes that will produce surfaces with gradual or abrupt irregularities not exceeding specified formwork surface class. Provide units with sufficient wall thickness to resist plastic concrete loads without detrimental deformation.
- G. Void Forms: Biodegradable paper surface, treated for moisture resistance, structurally sufficient to support weight of plastic concrete and other superimposed loads.
- H. Chamfer Strips: Wood, metal, PVC, or rubber strips, 3/4 by 3/4 inch, minimum.
- I. Rustication Strips: Wood, metal, PVC, or rubber strips, kerfed for ease of form removal.
- J. Form Ties and Hanger: Factory-fabricated, removable or snap-off metal or glass-fiber-reinforced plastic form ties designed to resist lateral pressure of fresh concrete on forms and to prevent spalling of concrete on removal.
 - 1. Furnish units that will leave no corrodible metal closer than 1 inch to the plane of exposed concrete surface.
 - 2. Furnish ties that, when removed, will leave holes no larger than 1 inch in diameter in concrete surface.

3. Furnish ties with integral water-barrier plates to walls indicated to receive damp-proofing or waterproofing.
 4. Commercially manufactured type. Wire is not acceptable.
 5. Portion remaining within concrete shall leave no metal within 1 inch of surface when concrete is exposed to view.
- K. Carton Forms: Double wall carton form, laminated using water resistant adhesive coated with paraffin containing 10 percent polyethylene. Assembled form shall be capable of supporting not less than 1,200 psf. Provide topping sheet of same material as carton forms for securely stapling to carton forms before reinforcement is placed to alleviate differential movement between carton form units and prevent leakage of concrete matrix.
- L. Spreader Cones: One inch diameter maximum for ties, except as otherwise required.
- M. Form Release Agent: Water resistant, non-staining, fast drying, sprayable liquid, non-toxic, water or non-water base, 100% chemically active type form release barrier for metal, wood, plastic and composition forms that prevents concrete from bonding or sticking to forms and which does not affect surfaces of concrete. Agent shall be ready-to-use without addition of any other material. Agent shall be compatible with concrete and formwork, not bond to or stain concrete, not transfer to or penetrate concrete surfaces, not deteriorate from exposure to ambient conditions, and not impair or affect adhesion of sealants, paints and like subsequent treatments of concrete surfaces.
1. Products: Subject to compliance with requirements, available products that may be incorporated into the Work include, but are not limited to, the following:
 - a. Basis-of-Design Product: L&M Construction Chemicals, Inc.; **Debond™** Form Coating, High Performance Concrete Form Releasing Agent.
 - b. Euclid Chemical Company (The), an RPM company, Form Shield Pure.
 - c. Nox-Crete Form Coating.
 - d. W.R. Meadows Duo Guard.
 2. Formulate form-release agent with rust inhibitor for steel form-facing materials.
 3. Physical Properties: Viscosity ASTM C88, Color Max ASTM D1500, and Flash Point ASTM D92.
- N. Embedded Angles:
1. Description: Prefabricated stainless steel angles with stainless steel studs welded to angles for cast-in-place installation embedded in concrete slabs.

2.2 REINFORCEMENT MATERIALS

- A. Reinforcing Bars - Standard: ASTM A615, Grade 60 minimum.
- B. Reinforcing Bars - Welded: ASTM A706, Grade 60, low alloy steel deformed bars; enhance weldability.
- C. Welded Wire Fabric - Standard: ASTM A185, flat sheets. Fabric in rolls not acceptable.
- D. Floor Joint Dowels: ASTM A615, Grade 60, plain bars, sawn to length.

- E. Zinc Repair Material: ASTM A 780, zinc-based solder, paint containing zinc dust, or sprayed zinc.
- F. Reinforcement Supports:
 - 1. General: Bolsters, chairs, spacers and other devices for supporting, spacing and fastening reinforcement in place. Supports shall meet requirements of ACI 315, ACI Detailing Manual and CRSI - Placing Reinforcing Bars.
 - 2. Wire Bar Supports:
 - a. Typical: CRSI Class 3, no protection, unless otherwise required. For slabs-on-ground, use supports with sand plates or horizontal runners where base course material will not support chair legs.
 - b. Exposed Concrete Surfaces: CRSI Class 1, plastic protected, for exposed-to-view in completed work or exposed to weather concrete surfaces where legs of supports are in contact with forms.
 - 3. Precast Concrete Block Bar Supports: Precast concrete block bar supports shall be 4 inches square minimum and shall have 28 day compressive strength not less than 28 day compressive strength required for adjacent concrete.
- G. Welding Electrodes: AWS A5.1, E70 Series, low hydrogen type.
- H. Drop-In Expansion Anchors: Carbon steel drop-in wedge type expansion anchors without nut for insertion of threaded end reinforcing bar meeting requirements of FS FF-S-325, Group II, Type 4, Class 1, and listed by EAMI, FMRC and UL. Anchors shall be zinc coated, FS QQ-Z-325, Type II, Class 3. Diameter and length shall be appropriate for application.
- I. Plate Dowel Assembly - Construction Joint:
 - 1. Plate: Diamond shaped load plate saw cut from ASTM A36 hot rolled steel plate, or saw cut from cold rolled steel plate for acceptable tolerances meeting ASTM 108 Grade 1018.
 - 2. Dowels: ASTM A675, Grade 60, round or square smooth dowels.
 - 3. Pocket Former: High density plastic to hold load plate in place, allowing for differential movement.
 - 4. Plastic Sleeve: ASTM D 695, polypropylene plastic
- J. Dowel Basket Assembly - Contraction and Control Joint:
 - 1. Plate: A36, load plate saw cut from hot rolled steel plate.
 - 2. Dowels:
 - a. ASTM A36, alternating tapered or double tapered plate dowels.
 - b. ASTM A 36, square or round dowels, with compressible form as required.
 - 3. ASTM A 108, Grade 1010-1020, 1/4 inch diameter cold drawn wire side frame supports.

2.3 CONCRETE MATERIALS

- A. Cements:

1. Portland Cement - General: ASTM C150, Type I, gray. Supplement with the following:
 - a. Fly Ash: ASTM C 618, Class F or C.
 - b. Ground Granulated Blast-Furnace Slag: ASTM C 989, Grade 100 or 120.
 2. Blended Hydraulic Cement: ASTM C 595, Type IS, Portland blast-furnace slag cement.
 3. Portland Cement - Moderate Sulfate Resistance: ASTM C150, Type II.
 4. Portland Cement - High Early Strength: ASTM C150, Type III.
- B. Silica Fume: ASTM C 1240, amorphous silica.
- C. Aggregates:
1. General:
 - a. Fine and coarse aggregates shall be regarded as separate ingredients.
 - b. Each size of coarse aggregate and combination of two or more shall meet gradation requirements of applicable ASTM aggregate standard.
 2. Normal Weight Concrete: ASTM C33, Class 3S coarse aggregate or better, graded. Provide aggregates from a single source. Local aggregate not meeting requirements of ASTM C33, but which has shown by special test or actual service to produce concrete of adequate strength, durability and appearance may be used when acceptable to Owner.
 - a. Maximum Coarse-Aggregate Size: 1 inch nominal.
 - b. Fine Aggregate: Free of materials with deleterious reactivity to alkali in cement.
- D. Water: Potable, fresh, clean and clear meeting requirements of ASTM C94. Do not use water which has been used to clean equipment or tools.
- E. Admixtures:
1. General: Each concrete admixture shall be compatible with other required admixtures for concrete mixes. Admixtures shall not contain calcium chloride, thiocyanates, more than 0.05 percent chloride ions, and chloride ions in excess of requirements specified for concrete mixes.
 2. Air-Entraining Admixture: ASTM C260
 3. Water-Reducing Admixture: ASTM C494, Type A.
 4. Retarding Admixture: ASTM C494, Type B.
 5. Accelerating Admixture: ASTM C494, Type C or Type E; non-corrosive, non-chloride; having one year minimum test data from an independent quality control service evaluated by an acceptable accelerated corrosion test method, such as test method using electrical potential measures, as acceptable to Architect.
 6. Water-Reducing and Retarding Admixture: ASTM C494, Type D.
 7. Water-Reducing and Accelerating Admixture: ASTM C494, Type E, non-corrosive, non-chloride; having one year minimum test data from an independent quality control service evaluated by an accelerated corrosion test method, such as test method using electrical potential measures, as acceptable to Architect.
 8. High Range Water-Reducing Admixture: ASTM C494, Type F.
 9. High Range Water-Reducing and Retarding Admixture: ASTM C494, Type G.

2.4 ADMIXTURES

- A. Air-Entraining Admixture: ASTM C 260.
- B. Chemical Admixtures: Provide admixtures certified by Manufacturer to be compatible with other admixtures and that will not contribute water-soluble chloride ions exceeding those permitted in hardened concrete. Do not use calcium chloride or admixtures containing calcium chloride.
 - 1. Water-Reducing Admixture: ASTM C 494, Type A.
 - 2. Retarding Admixture: ASTM C 494, Type B.
 - 3. Water-Reducing and Retarding Admixture: ASTM C 494, Type D.
 - 4. High-Range, Water-Reducing Admixture: ASTM C 494, Type F.
 - 5. High-Range, Water-Reducing and Retarding Admixture: ASTM C 494, Type G.
 - 6. Plasticizing and Retarding Admixture: ASTM C 1017, Type II.
- C. Non-Set-Accelerating Corrosion-Inhibiting Admixture: Commercially formulated, non-set-accelerating, anodic inhibitor or mixed cathodic and anodic inhibitor; capable of forming a protective barrier and minimizing chloride reactions with steel reinforcement in concrete.
 - 1. Products: Subject to compliance with requirements, available products that may be incorporated into the Work include, but are not limited to, the following:
 - a. BASF Construction Chemicals - Building Systems; Rheocrete 222+.
 - b. Sika Corporation; FerroGard 901.

2.5 VAPOR RETARDER FOR SLAB-ON-GRADE CONCRETE FLOORS

- A. Basis-of-Design Manufacturer:
 - 1. **Griffolyn Type 105** Vapor Retarder.
 - 2. Material: 7 ply laminate combining 4 layers of high density polyethylene and 3 high strength non-woven cord grids.
 - 3. Weight: ASTM D 3776, 82 lb/1,000 SF.
 - 4. Puncture Propagation Tear: ASTM D 2582, 45 lb.
 - 5. Permeance (Perm): ASTM E 96, 0.021 grains/hr-SF in HG.
 - 6. Drop Dart: ASTM D 1709, 2,300 g.
 - 7. Tensile Strength: 3 inches, ASTM D 882, 275 lb/5,464 psi.
 - 8. Puncture Strength: ASTM D 4833, 72 lb.
 - 9. Usable Temperature Range: -45 to 170 degrees.
 - 10. Tape: Pressure-sensitive tape of type recommended by vapor retarder Manufacturer for sealing joints and penetrations in vapor retarder.
 - 11. No substitution permitted.

2.6 CURING AND SEALING MATERIALS

- A. Non-Residual Curing Compound: VOC Compliant, ready to use, non-residual concrete curing agent that penetrates surfaces to cure the concrete from within. Water-based, clear, sprayable liquid that offers residue free performance.
1. Products: Subject to compliance with requirements, available products that may be incorporated into the Work include, but are not limited to, the following:
 - a. Basis-of-Design Product: L&M Construction Chemicals, Inc.; **Cure™**, Non-Residual Curing Compound.
 - b. BASF Sonosil.
 - c. Euclid Chemical Company (The), an RPM company, Eucosil.
 - d. Nox-Crete Bro-Cure RTU.
 - e. W.R. Meadows Med-Cure.
 2. Refer to Floor Slab Treatment and Curing and Sealing Schedule this section for application for this product.
 3. Install product in accordance with Manufacturer's installation instructions.
 4. Prep concrete surface as recommended by the coating Manufacturer.
- B. Concrete Sealer, Densifier, Dustproofer, Chemical Hardener: Proprietary, colorless, environmentally safe chemical solution that increases the wear surface strength of concrete floors subject to pedestrian and vehicle traffic.
1. Products: Subject to compliance with requirements, available products that may be incorporated into the Work include, but are not limited to, the following:
 - a. Basis-of-Design Product: L&M Construction Chemicals, Inc.; **Seal Hard™**, Concrete Sealer, Densifier, Dustproofer, Chemical Hardener.
 - b. Approved equal product by Euclid Chemical Company (The), an RPM company, Sika, or W.R. Meadows.
 2. Refer to Floor Slab Treatment and Curing and Sealing Schedule this section for application for this product.
 3. Install product in accordance with Manufacturer's installation instructions
 4. Prep concrete surface as recommended by the coating Manufacturer.
- C. Stain Protection: Quick drying, low odor, water-based solution containing VOC compliant emulsion of organic, cross-linking, low molecular weight polymers. That penetrates and leaves a non-darkening film that protects concrete floor from oil drippings, food stains, and other contaminant penetration.
1. Products: Subject to compliance with requirements, available products that may be incorporated into the Work include, but are not limited to, the following:
 - a. Basis-of-Design Product: L&M Construction Chemicals, Inc.; **PermaGuard SPS™**, vaporation Reducer for Plastic Concrete.
 - b. Approved equal product by Euclid Chemical Company (The), an RPM company, Sika, or W.R. Meadows.
 - c. Do not apply if surface temperature is below 40°F or above 100°F.
 - d. Install product in accordance with Manufacturer's installation instructions
 - e. Prep concrete surface as recommended by the coating Manufacturer.

2. Refer to Floor Slab Treatment and Curing and Sealing Schedule this section for application for this product.
- D. Concrete Dye: Translucent decorative concrete penetrating dye. Dry power mix to be field mixed with acetone.
1. Products: Subject to compliance with requirements, available products that may be incorporated into the Work include, but are not limited to, the following:
 - a. Basis-of-Design Product: L&M Construction Chemicals, Inc.; **Vivid Concrete Dye™**, translucent decorative concrete dye.
 - b. Approved equal product by Euclid Chemical Company (The), an RPM company, Sika, or W.R. Meadows.
 - c. Color to be **selected by Owner**.
 - d. Install product in accordance with Manufacturer's installation instructions.
 - e. Prep concrete surface as recommended by the coating Manufacturer.
 2. Refer to Floor Slab Treatment and Curing and Sealing Schedule this section for application for this product.
- E. Breathable, Micro-Emulsion, Silane/Siloxane Water Repellents for Horizontal Concrete Surfaces: New generation, 100% reactive, waterborne silane-siloxane sealer.
1. Products: Subject to compliance with requirements, available products that may be incorporated into the Work include, but are not limited to, the following:
 - a. L&M Construction Chemicals, Inc.; **Aquapel+Plus™**, Oil and Water Repellent for Concrete, Masonry and Stone Surfaces.
 - b. BASF Enviroseal 40.
 - c. Euclid Chemical Company (The), an RPM company, Eucoguard 200.
 - d. Nox-Crete Stiffel SC.
 2. Refer to Floor Slab Treatment and Curing and Sealing Schedule this section for application for this product.
- F. Absorptive Cover: ASSHTO M 182, Class 2, burlap cloth made from jute or kenaf, weighing approximately 9 oz./sq. yd. when dry.
- G. Moisture-Retaining Cover: ASTM C 171, polyethylene film or white burlap-polyethylene sheet.
- H. Water: Potable, fresh, clean and clear meeting requirements of ASTM C94. Do not use water which has been used to clean equipment or tools.
- I. Clear, Waterborne, Membrane-Forming Curing Compound: ASTM C 309, Type 1, Class B, dissipating.
1. Products: Subject to compliance with requirements, available products that may be incorporated into the Work include, but are not limited to, the following:
 - a. Anti-Hydro International, Inc.; AH Curing Compound #2 DR WB.
 - b. BASF Construction Chemicals - Building Systems; Kure 200.

- c. ChemMasters; Safe-Cure Clear.
- d. Conspec by Dayton Superior; W.B. Resin Cure.
- e. Dayton Superior Corporation; Day-Chem Rez Cure (J-11-W).
- f. Edoco by Dayton Superior; Res X Cure WB.
- g. Euclid Chemical Company (The), an RPM company; Kurez W VOX; TAMMSCURE WB 30C.
- h. Kaufman Products, Inc.; Thinfilm 420.
- i. Lambert Corporation; AQUA KURE - CLEAR.
- j. Basis-of-Design Product: L&M Construction Chemicals, Inc.; **Cure R**.
- k. Meadows, W. R., Inc.; 1100-CLEAR.
- l. Nox-Crete Products Group; Resin Cure E.
- m. Right Pointe; Clear Water Resin.
- n. SpecChem, LLC; Spec Rez Clear.
- o. Symons by Dayton Superior; Resi-Chem Clear.
- p. TK Products, Division of Sierra Corporation; TK-2519 DC WB.
- q. Vexcon Chemicals, Inc.; Certi-Vex Enviocure 100.

- 2. Install product in accordance with Manufacturer's installation instructions.

2.7 SLIP RESISTIVE FINISH

- A. Non-Slip Aluminum Oxide Floor Treatment: Mineral emory magnetite non-slip aggregate with more than 56% aluminum oxide and 24% ferric oxide.
 - 1. Products: Subject to compliance with requirements, available products that may be incorporated into the Work include, but are not limited to, the following:
 - a. Basis-of-DesignProduct: L&M Construction Chemicals, Inc.; **Grip-It™**, Non-Slip Aluminum Oxide Floor Treatment.
 - b. BASF Frictex NS.
 - c. Euclid Chemical Company (The), an RPM company, Non-Slip Aggregate.
 - 2. Contains no Portland cement.
 - 3. Will not rust or stain concrete surface.
 - 4. Install on all interior concrete surfaces that are noted to be exposed (no floor finish).
 - 5. Install product in accordance with Manufacturer's installation instructions.
 - 6. Refer to Floor Slab Treatment and Curing and Sealing Schedule this section for application for this product.

2.8 STRUCTURAL GROUT

- A. Ready-mixed, non-shrink, non-metallic, flowable, high-strength structural grout containing a blend of washed and graded silica sands, Portland cement, and flow improvement compounds for steel base plates.
 - 1. Products: Subject to compliance with requirements, available products that may be incorporated into the Work include, but are not limited to, the following:

- a. Basis-of-Design Product: L&M Construction Chemicals, Inc.; **Duragrout™**, General Purpose, Non-Shrink Structural Grout.
 - b. BASF Masterflow 555.
 - c. Euclid Chemical Company (The), an RPM company, NS Grout.
 - d. Sika Grout 212.
 - e. W.R. Meadows 588-10K.
- 2. Technical Standards: ASTM C1107.
 - 3. Install product in accordance with Manufacturer's installation instructions.
- B. Follow ACI recommended practices and ASTM C 1107 and CRD C 621.
 - C. Store, mix, and install in accordance with Manufacturer's requirements.
 - D. Do not mix more structural grout than can be placed within 30 minutes of mixing.
 - E. Do not mix or place structural grout below 40 degrees F within 24 hours.
 - F. Do not over vibrate fluid consistency grout.
 - G. Refer to Structural Drawings for additional requirements.

2.9 CONTROL JOINT FILLER

- A. Rapid Curing, Polyurea Based, Control Joint Filler: USDA approved. Self-leveling, 100% solids, two component, rapid curing, polyurea control joint and crack filler.
 - 1. Products: Subject to compliance with requirements, available products that may be incorporated into the Work include, but are not limited to, the following:
 - a. Basis-of-Design Product: L&M Construction Chemicals, Inc.; **Joint Tile 750™**, Oil and Water Repellent for Concrete, Masonry and Stone Surfaces.
 - b. Approved equal product by Metzger McGuire, MM-80.
 - 2. Install product in accordance with Manufacturer's installation instructions.
 - 3. Refer to Section 241080 Joint Sealants for joint filler for isolation joints.

2.10 FLOOR SLAB TREATMENT COATINGS AND **CURING AND SEALING SCHEDULE**

- A. Typical Concrete Floors:
 - 1. All horizontal interior concrete floor locations (not specified to receive epoxy):
 - a. 1-coat: **L&M "Cure."**
 - b. 2-coats: **L&M "Vivid Dye."**
 - c. 2-coats: **L&M "Seal Hard."**
 - d. Control joint filler.
 - e. 1-coat: **L&M "PermaGuard."**
 - f. Non-slip Aluminum Oxide aggregate: **L&M "Grip-it."**

2. All horizontal exterior concrete slab locations:

- a. 1-coat: **L&M “Cure.”**
- b. 1-coat: **L&M “Aquapel Plus.”**

2.11 EMBEDDED CHANNELS

- A. Provide stainless steel channels embedded into concrete floor for project tie-downs and continuous channels (12' sections installed continuously) at perimeter of three project bays. Coordinate embedded channels with floor reinforcing. Install channels flush with top of floor slab. Channels to have stainless steel studs at 10" o.c. or minimum of 2 for individual tiedowns. Channels to accept 3/4" threaded bolts.
- B. Basis-of-Design: **Sharktooth Insert** by Hohmann & Barnard, Inc., 30 Rasons Court, Hauppauge, NY 11788, phone: (800)-645-0616.
- C. Provide **100 - 3/4"** stainless steel spring loaded threaded bolts Manufactured by H&B designed specifically for the Sharktooth channel.

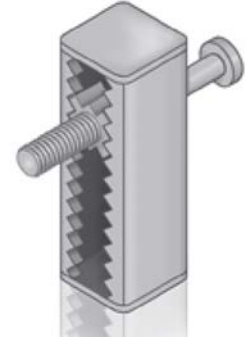

2.12 SLIP RESISTANT STAIR NOSINGS

- A. Manufacturer's standard 4" wide cast aluminum slip resistant cross hatched fluted abrasive nosing cast into poured-in-place concrete with wing anchors.
- B. Surface to have silicon carbide abrasive, a minimum of 2-1/4ounces per square foot to a minimum of 1/32 of an inch.
- C. All castings to be of uniform quality, free from blow holes, shrinkage defects, swells, cracks, or other defects.
- D. Treads to be true to pattern.
- E. Castings to be free of fins, burrs and slag.
- F. Aluminum to have a natural sand cast finish.
- G. Install at leading edge of all concrete stair nosings.
- H. Manufacturer: Barry Pattern & Foundry Co, Birmingham, AL, or equal.

2.13 ACCESSORIES

- A. Preformed Bentonite Waterstops: Flexible strip concrete construction joint waterstop, composed of sodium bentonite and butyl rubber, that provides a watertight seal to hydrostatic water pressure of 150 feet minimum under continuous water emersion and wet/dry cycling. Configuration and size of waterstop shall suit joint conditions as instructed and recommended by Manufacturer.

1. Products: Subject to compliance with requirements, available products that may be incorporated into the Work include, but are not limited to, the following:
 - a. Carlisle Coatings & Waterproofing, Inc.; MiraSTOP.
 - b. CETCO; Volclay Waterstop-RX.
 - c. Concrete Sealants Inc.; Conseal CS-231.
 - d. Greenstreak; Swellstop.
 - e. Henry Company, Sealants Division; Hydro-Flex.
 - f. JP Specialties, Inc.; Earth Shield Type 20.

- B. Expansion and Isolation Joint Filler Strips: ASTM D 1751, asphalt-saturated cellulosic fiber.

- C. Inserts and Anchors:
 1. General: As furnished under specification section for work which inserts, anchors and like items are required.
 2. Wedge inserts.
 3. Continuous slotted inserts.
 4. Dovetail Anchor Slots: Hot-dip zinc coated sheet steel of 0.0359 inch minimum thickness with bent tab anchors. Slot shall be filled with temporary filler or cover face opening to prevent intrusion of concrete or debris.
 5. Concrete Reglets: Hot-dip zinc coated sheet steel of .022 inch thickness of profile to terminate flashing and membranes as applicable. Slot shall be filled with temporary filler or cover face opening to prevent intrusion of concrete or debris.

- D. Evaporation Retarder: Polymer monomolecular film forming material applied to exposed surfaces of fresh, plastic concrete to retard evaporation of moisture. Retarder shall be compatible with concrete materials and not have an effect on cement hydration process.

- E. Concrete Surface Retardant: Spray applied, water-thin, water soluble, non-flammable liquid that retards, but not prevent, setting of concrete surface mortar. Retardant shall have a non-staining color to assure uniform coating application.

- F. Bonding Agent: ASTM C 1059, Type II, non-redispersible, acrylic emulsion or styrene butadiene.

- G. Bonding Adhesive - Epoxy: Two component, 100 percent solids, moisture insensitive, high modulus of elasticity, structural epoxy resin material for bonding freshly mixed concrete to hardened concrete, meeting requirements of ASTM C881, Type V, Grade and Class suitable for application.

- H. Polymer Patching Mortar: Polymer modified cementitious mortar meeting requirements of ASTM C1059, Type II, for concrete repair of horizontal, vertical and overhead applications.

- I. Bonding Admixture: Non-reemulsifiable bonding admixture meeting requirements of ASTM C1059, Type II, to be integral adhesive for mortars and concrete to improve bond strength, durability and wear resistance.

- J. Zinc Coating Repair Paint - Hot-Dip: Zinc-rich paint for repair of damaged areas of hot-dip zinc coated steel surfaces meeting requirements of ASTM A780, SSPC Paint 20 and USDOD P-21035.

- K. Sealants: As specified in Section 241080 - Joint Sealants.

2.14 REPAIR MATERIALS

- A. Repair Underlayment: Cement-based, polymer-modified, self-leveling product that can be applied in thicknesses from 1/8 inch and that can be feathered at edges to match adjacent floor elevations.
 - 1. Cement Binder: ASTM C 150, Portland cement or hydraulic or blended hydraulic cement as defined in ASTM C 219.
 - 2. Primer: Product of underlayment Manufacturer recommended for substrate, conditions, and application.
 - 3. Aggregate: Well-graded, washed gravel, 1/8 to 1/4 inch or coarse sand as recommended by underlayment Manufacturer.
 - 4. Compressive Strength: Not less than 4100 psi at 28 days when tested according to ASTM C 109.
- B. Repair Overlayment: Cement-based, polymer-modified, self-leveling product that can be applied in thicknesses from 1/4 inch and that can be filled in over a scarified surface to match adjacent floor elevations.
 - 1. Cement Binder: ASTM C 150, Portland cement or hydraulic or blended hydraulic cement as defined in ASTM C 219.
 - 2. Primer: Product of topping Manufacturer recommended for substrate, conditions, and application.
 - 3. Aggregate: Well-graded, washed gravel, 1/8 to 1/4 inch or coarse sand as recommended by topping Manufacturer.
 - 4. Compressive Strength: Not less than 5000 psi at 28 days when tested according to ASTM C 109.
- C. Refer to Section 240010 "Maintenance of Cast-in-Place Concrete for additional materials for repairing concrete slabs.

2.15 PROPORTIONING AND DESIGNING MIXES

- A. General:
 - 1. Proportion concrete meeting requirements of ACI 301 and as specified in this Section.
 - 2. Prepare design mixtures for each type and strength of concrete, proportioned on the basis of laboratory trial mixture or field test data, or both, according to ACI 301.
 - a. Use a qualified independent testing agency for preparing and reporting proposed mixture designs based on laboratory trial mixtures.
 - 3. Cement used in work shall correspond to cement used in mix design submittals.
 - 4. Water/Cement Ratio:

- a. Normal Weight Concrete: Meet requirements of ACI 211.1, but 0.50 maximum, except as otherwise required. If historical data and general practice in locality of usage substantiates using a higher water/cement ratio, Contractor shall submit written request with documentation to Quality Control Service for review, including mix performance history from concrete mix supplier. Also submit procedures which will minimize potential for cracking due to shrinkage resulting from higher water content.
 - 5. Chloride Ions: Maximum water soluble chloride ion concentrations in hardened concrete at age from 28 to 42 days, contributed from concrete components, including cementitious materials, aggregates, water, admixtures and other ingredients, shall not exceed following limits when evaluated meeting requirements of Soxhlet Method:
 - a. Concrete In Contact with Ground: 0.15 percent by weight of cement.
 - b. Concrete, Dry while in Service: 0.30 percent by weight of cement.
 - c. Other Concrete Construction: 0.15 percent by weight of cement.
- B. Cementitious Materials: Use fly ash, pozzolan, ground granulated blast-furnace slag, and silica fume as needed to reduce the total amount of Portland cement, which would otherwise be used, by not less than 40 percent. Limit percentage, by weight, of cementitious materials other than Portland cement in concrete as follows:
- 1. Fly Ash: 25 percent.
 - 2. Combined Fly Ash and Pozzolan: 25 percent.
 - 3. Ground Granulated Blast-Furnace Slag: 50 percent.
 - 4. Combined Fly Ash or Pozzolan and Ground Granulated Blast-Furnace Slag: 50 percent Portland cement minimum, with fly ash or pozzolan not exceeding 25 percent.
 - 5. Silica Fume: 10 percent.
 - 6. Combined Fly Ash, Pozzolans, and Silica Fume: 35 percent with fly ash or pozzolans not exceeding 25 percent and silica fume not exceeding 10 percent.
 - 7. Combined Fly Ash or Pozzolans, Ground Granulated Blast-Furnace Slag, and Silica Fume: 50 percent with fly ash or pozzolans not exceeding 25 percent and silica fume not exceeding 10 percent.
- C. Strength:
- 1. Normal Weight Concrete: Base strength requirements on 28 day compressive strengths, unless high early strength cement is used, in which case required strengths shall be obtained at 7 days.
- D. Air Entrainment:
- 1. Normal Weight Concrete:
 - a. Total air content of concrete used in interior flatwork, not exposed to potential destructive exposure, shall be 3 percent maximum of volume of concrete and uniform for work.
 - b. Total air content of concrete used in all other locations shall be 4 percent minimum to 7 percent maximum of volume of concrete, and uniform for work.

- c. Evaluate air content meeting requirements of ASTM C231 or ASTM C138.
 - 2. Durability: Provide concrete that will be subject to potentially destructive exposure, other than wear or loading, such as freezing and thawing, severe weather, chemicals, or deicing salts, as follows:
 - a. Normal Weight Concrete:
 - 1) Containing entrained air meeting requirements of ACI 318.
 - 2) Water/cement ratio of 0.45 maximum.
 - E. Slump:
 - 1. General: Maximum slump shall be 4-1/2". Slump tolerance of 1 inch above maximum limit for individual batches, provided average for all batches or most recent five batches tested, whichever is fewer, does not exceed maximum limit.
 - 2. Normal Weight Concrete:
 - a. Evaluate slump meeting requirements of ASTM C143.
 - b. Slump of normal weight concrete enhanced with high-range water-reducing admixture:
 - 1) Minimum slump shall be 6 inches and maximum slump shall be 8 inches. Slump range shall be confirmed by Quality Control Service during review of concrete mix designs.
 - 2) Concrete with plant added high-range water-reducing admixture shall be sampled immediately upon arrival at project site. Batches delivered to site with slump in excess of 10 inches shall be rejected. Batches delivered to site with slump less than 7 inches shall be redosed with same admixture as used at plant, to increase slump to within acceptable range. Redosing shall be monitored by Quality Control Service.
 - 3) Concrete with project site added high-range water-reducing admixture shall be sampled immediately upon arrival at project site for conformance to slump requirements specified in this Section. Adjust slump to maximum permissible in accordance with slump requirements specified in this Section prior to dosage. Quality Control Service shall monitor addition of admixture. After dosage, check slump and consistency as specified.
- F. Gradation of aggregates for each class and type concrete to be used in work, including concrete for slabs-on-ground, suspended slabs, walls, columns, beams and other concrete elements, shall be well graded from coarse to fine. Gap gradation is not acceptable.
- G. Maximum Size of Coarse Aggregate:
 - 1. Nominal Maximum Size:
 - a. Limit to not larger than 1/5 of narrowest dimension between sides of forms, 1/3 of depth of slabs, nor 3/4 of minimum clear distance between reinforcement or between reinforcing bars and side forms, whichever is least.

- b. In piers/pedestals/columns, limit nominal maximum size of coarse aggregate as specified above, but not larger than 2/3 of minimum clear distance between reinforcing bars.
 - c. In slabs-on-ground, provide coarse aggregate with minimum nominal size of 1 inch and maximum nominal size of 1-1/2 inches.
2. Normal Weight Concrete:
- a. One size of coarse aggregate for concrete placed in one day when quantities to be placed are too small to permit economical use of more than one mix design.
 - b. When single mix design is used, nominal maximum size of coarse aggregate shall be as required for most critical conditions of concreting, meeting requirements of preceding paragraph.

H. Admixtures: Use admixtures according to Manufacturer's written instructions

- 1. General: Two or more admixtures may be used in same concrete, provided admixtures are added separately during batching sequence. Admixtures used in combination shall retain full efficiency and have no deleterious effect on concrete or on properties of each other.
- 2. Use water-reducing or plasticizing admixture in concrete, as required, for placement and workability.
- 3. Use water-reducing and retarding admixture when required by high temperatures, low humidity, or other adverse placement conditions.
- 4. Use water-reducing admixture in pumped concrete, concrete for heavy-use industrial slabs and parking structure slabs, concrete required to be watertight, and concrete with a water-cementitious materials ratio below 0.50.
- 5. Use corrosion-inhibiting admixture in concrete mixtures where indicated.
- 6. Prohibited Admixtures: Calcium chloride, thiocyanates, and admixtures containing chloride ions more than permitted by requirements of this Section.
- 7. Air-Entrained Admixtures and Proprietary Chemical Admixtures: Meet instructions and recommendations of Manufacturer.
- 8. Accelerators: An accelerator may be used in proportions instructed and recommended by Manufacturer when ambient air temperature during concrete placement is less than 40 F.

I. Color Pigment: Add color pigment to concrete mixture according to Manufacturer's written instructions and to result in hardened concrete color consistent with approved mockup.

2.16 CONCRETE MIXTURES FOR BUILDING ELEMENTS

A. Footings: Proportion normal-weight concrete mixture as follows:

- 1. Minimum Compressive Strength: 4000 psi at 28 days.
- 2. Slump Limit: 8 inches for concrete with verified slump of 2 to 4 inches before adding high-range water-reducing admixture or plasticizing admixture
- 3. Air Content: 5.5 percent, plus or minus 1.5 percent at point of delivery for 1-1/2-inch nominal maximum aggregate size.

B. Foundation Walls/Retaining Walls: Proportion normal-weight concrete mixture as follows:

1. Minimum Compressive Strength: 4000 psi at 28 days.
 2. Maximum Water-Cementitious Materials Ratio: 0.50.
 3. Slump Limit: 8 inches for concrete with verified slump of 2 to 4 inches before adding high-range water-reducing admixture or plasticizing admixture.
 4. Air Content: 5.5 percent, plus or minus 1.5 percent at point of delivery for 1-1/2-inch nominal maximum aggregate size.
- C. Slabs-on-Grade/Exterior Pads/Toppings on metal deck: Proportion normal-weight concrete mixture as follows:
1. Minimum Compressive Strength: 3500 psi at 28 days (interior only), 4500 psi at 28 days (exterior only).
 2. Maximum Water-Cementitious Materials Ratio: 0.45 (exterior only).
 3. Slump Limit: 8 inches for concrete with verified slump of 2 to 4 inches before adding high-range water-reducing admixture or plasticizing admixture
 4. Air Content(exterior only): 5.5 percent, plus or minus 1.5 percent at point of delivery for 1-1/2-inch nominal maximum aggregate size.
 5. Air Content(interior): Do not allow air content of trowel-finished floors to exceed 3 percent.

2.17 CONCRETE MIXING

- A. General:
1. Meet requirements of ACI 301.
 2. Mix and transport ready mixed concrete meeting requirements of ASTM C94, except concrete slump shall meet requirements of this Section. Ready mix producer shall be certified for compliance to NRMCA Standards.
- B. Ready-Mixed Concrete: Measure, batch, mix, and deliver concrete according to ASTM C 94 and ASTM C 1116, and furnish batch ticket information.
1. When air temperature is between 85 and 90 deg F, reduce mixing and delivery time from 1-1/2 hours to 75 minutes; when air temperature is above 90 deg F, reduce mixing and delivery time to 60 minutes.
- C. Project-Site Mixing: Measure, batch, and mix concrete materials and concrete according to ASTM C 94. Mix concrete materials in appropriate drum-type batch machine mixer.
1. For mixer capacity of 1 cu. yd. or smaller, continue mixing at least 1-1/2 minutes, but not more than 5 minutes after ingredients are in mixer, before any part of batch is released.
 2. For mixer capacity larger than 1 cu. yd., increase mixing time by 15 seconds for each additional 1 cu. yd.
 3. Provide batch ticket for each batch discharged and used in the Work, indicating Project identification name and number, date, mixture type, mixture time, quantity, and amount of water added. Record approximate location of final deposit in structure.
- D. Re-tempering:
1. Mix concrete only in quantities for immediate use.

2. Do not re-temper concrete which has set, discard.

E. Weather Conditions:

1. Cold Weather: Meet requirements of ACI 306R.
2. Hot Weather: Meet requirements of ACI 305R.

2.18 REINFORCEMENT FABRICATION

A. General: Fabricate reinforcing bars to required shapes and dimensions meeting requirements of ACI 315 and CRSI - Manual of Standard Practice. Do not re-bend or straighten reinforcement in a manner that will injure or weaken materials.

PART 3 - EXECUTION

3.1 EXAMINATION

A. Flatwork Base Course:

1. Material: Base course material under concrete slabs-on-ground, including any leveling material, shall not be sand.
2. Surface Tolerance: Verify elevation tolerance of compacted base course surface is within plus 0 inch and minus 1 inch of required bottom of slab-on-ground elevation when tested with a 10 foot straightedge, in any direction. Utility piping, including plumbing, sewer, electrical and like items, shall be below top of base course.
3. Base Course Modulus of Reaction: Verify with Quality Control Service, modulus of reaction of base course for slabs-on-ground, within 14 days of placement of concrete, is equal to or more than modulus that was assumed in slab-on-ground thickness design.

B. Floor Insulation: For concrete to be installed over insulation, tolerance of insulation shall be plus or minus 1/4 inch from underside of concrete slab elevation.

3.2 FORMWORK

A. Design: Contractor is responsible for design and engineering of formwork, and formwork construction.

B. Configuration: Use forms wherever necessary to confine and shape concrete to required dimensions. Provide forms with sufficient strength to withstand pressure resulting from placement and vibration of concrete, and sufficient rigidity to maintain specified tolerances.

C. Unformed Foundation Elements: Do not provide unformed foundation elements (excavated earth forms) for vertical foundation elements, except as otherwise indicated or acceptable to Architect. When use of earth forms is acceptable, meet applicable ACI requirements.

D. Meet design considerations and allowable stresses of ACI 347-88, Section 2.3, and requirements of codes and regulations of public authorities having jurisdiction over the Work. Limit concrete surface irregularities, as designated in ACI 347R.

- E. Provide formwork to provide concrete surfaces meeting tolerances of ACI 347R-88, Section 3.3.
- F. Design, erect, shore, brace, and maintain formwork, according to ACI 301, to support vertical, lateral, static, and dynamic loads, and construction loads that might be applied, until structure can support such loads.
- G. Construct formwork so concrete members and structures are of size, shape, alignment, elevation, and position indicated, within tolerance limits of ACI 117.
- H. Limit concrete surface irregularities, designated by ACI 347 as abrupt or gradual, as follows:
 - 1. Class A, 1/8 inch for smooth-formed finished surfaces.
- I. Construct forms tight enough to prevent loss of concrete mortar.
- J. Fabricate forms for easy removal without hammering or prying against concrete surfaces. Provide crush or wrecking plates where stripping may damage cast concrete surfaces. Provide top forms for inclined surfaces steeper than 1.5 horizontal to 1 vertical.
 - 1. Install keyways, reglets, recesses, and the like, for easy removal.
 - 2. Do not use rust-stained steel form-facing material.
- K. Set edge forms, bulkheads, and intermediate screed strips for slabs to achieve required elevations and slopes in finished concrete surfaces. Provide and secure units to support screed strips; use strike-off templates or compacting-type screeds.
- L. Provide temporary openings for cleanouts and inspection ports where interior area of formwork is inaccessible. Close openings with panels tightly fitted to forms and securely braced to prevent loss of concrete mortar. Locate temporary openings in forms at inconspicuous locations.
- M. Chamfer exterior corners and edges of permanently exposed concrete.
- N. Form openings, chases, offsets, sinkages, keyways, reglets, blocking, screeds, and bulkheads required in the Work. Determine sizes and locations from trades providing such items.
- O. Clean forms and adjacent surfaces to receive concrete. Remove chips, wood, sawdust, dirt, and other debris just before placing concrete.
- P. Retighten forms and bracing before placing concrete, as required, to prevent mortar leaks and maintain proper alignment.
- Q. Coat contact surfaces of forms with form-release agent, according to Manufacturer's written instructions, before placing reinforcement.

3.3 REMOVING AND REUSING FORMS

- A. General: Formwork for sides of beams, walls, columns, and similar parts of the Work that does not support weight of concrete may be removed after cumulatively curing at not less than 50

deg F for 24 hours after placing concrete. Concrete has to be hard enough to not be damaged by form-removal operations and curing and protection operations need to be maintained.

1. Leave formwork for beam soffits, joists, slabs, and other structural elements that supports weight of concrete in place until concrete has achieved at least 70 percent of its 28-day design compressive strength.
 2. Remove forms only if shores have been arranged to permit removal of forms without loosening or disturbing shores.
- B. Clean and repair surfaces of forms to be reused in the Work. Split, frayed, delaminated, or otherwise damaged form-facing material will not be acceptable for exposed surfaces. Apply new form-release agent.
- C. When forms are reused, clean surfaces, remove fins and laitance, and tighten to close joints. Align and secure joints to avoid offsets. Do not use patched forms for exposed concrete surfaces unless approved by Owner.

3.4 PLACING REINFORCEMENT

- A. General: Meet requirements of ACI 301, ACI 315 and CRSI - Manual of Standard Practice.
- B. Welding:
1. Welding of reinforcing steel shall meet requirements of AWS D1.4.
 2. Do not weld reinforcing steel.
 3. Do not weld reinforcing steel at bends.
- C. Unformed Foundation Elements: When unformed foundation elements (excavated earth forms) are used, provide applicable ACI required concrete coverage to reinforcing steel.
- D. Carton Forms: Carefully place reinforcement at elevations on dry carton forms with top sheet securely stapled in place. If carton forms are rained on after reinforcement is placed, remove reinforcement and either replace carton forms or dry carton forms instructions and recommendations of Manufacturer.

3.5 EMBEDDED ITEMS

- A. General: Provide reinforcement for anchorage of embedded items for work attached to or supported by cast-in-place concrete when rated load capacity of embedded items exceeds pull-out tension or when required for proper anchorage. Use setting drawings, templates, diagrams, instructions, and directions furnished with items to be embedded.
1. Give ample notice and opportunity to introduce, furnish or install embedded items and work related to concrete or for support before concrete is placed.
 2. Position embedded items accurately and support against displacement.
 3. No embedded items made of aluminum shall be permitted, unless completely coated or covered to prevent aluminum concrete reaction or electrolytic action between aluminum and steel.

B. Sleeves, Inserts and Anchors:

1. Place sleeves, inserts, anchors and embedded items required for adjoining work or for support prior to concreting as applicable. Instructions of applicable Manufacturers for work which sleeves, inserts, anchors and embedded items are required.
2. Provide anchorage for embedded items.
3. Fill voids in sleeves, inserts and anchor slots temporarily with removable material to prevent entry of concrete into void space.
4. Install anchor rods, accurately located, to elevations required and complying with tolerances in Section 7.5 of AISC's "Code of Standard Practice for Steel Buildings and Bridges."
5. Install reglets to receive waterproofing and to receive through-wall flashings in outer face of concrete frame at exterior walls, where flashing is shown at lintels, shelf angles, and other conditions.
6. Install dovetail anchor slots in concrete structures as indicated.

C. Hairpin Reinforcing:

1. Reinforce embedded items with hairpin reinforcing bars of Number 3 size minimum and so pull-out strength of embedment exceeds 500 percent of calculated total load.
2. Configuration of hairpins shall include hook ends which project outward at 90 degrees from bar.
3. Place hairpin reinforcing through eye or other like feature of embedment so hook ends are restrained by reinforcing steel.

D. Conduit for Slabs on Grade: Do not embed conduit in concrete for slabs-on-grade. Conduit shall be placed under slab.

E. Conduit for Suspended Slabs: Only vertical penetrating conduit shall be placed in suspended concrete slabs.

3.6 JOINTS

A. General: Construct joints true to line with faces perpendicular to surface plane of concrete. Meet requirements of ACI 302, ACI 306.

B. Construction Joints: Install so strength and appearance of concrete are not impaired, at locations indicated or as approved by Owner.

1. Place joints perpendicular to main reinforcement. Continue reinforcement across construction joints unless otherwise indicated. Do not continue reinforcement through sides of strip placements of floors and slabs.
2. Form keyed joints as indicated. Embed keys at least 1-1/2 inches into concrete.
3. Locate joints for beams, slabs, joists, and girders in the middle third of spans. Offset joints in girders a minimum distance of twice the beam width from a beam-girder intersection.
4. Locate horizontal joints in walls and columns at underside of floors, slabs, beams, and girders and at the top of footings or floor slabs.
5. Space vertical joints in walls as directed by Structural Engineer. Locate joints beside piers integral with walls, near corners, and in concealed locations where possible.

6. Use a bonding agent at locations where fresh concrete is placed against hardened or partially hardened concrete surfaces.
 7. Use epoxy-bonding adhesive at locations where fresh concrete is placed against hardened or partially hardened concrete surfaces.
- C. Contraction Joints in Slabs-on-Grade: Form weakened-plane contraction joints, sectioning concrete into areas as indicated. Construct contraction joints for a depth equal to at least one-fourth of concrete thickness as follows:
1. Grooved Joints: Form contraction joints after initial floating by grooving and finishing each edge of joint to a radius of 1/8 inch. Repeat grooving of contraction joints after applying surface finishes. Eliminate groover tool marks on concrete surfaces.
 2. Sawed Joints: Form contraction joints with power saws equipped with shatterproof abrasive or diamond-rimmed blades. Cut 1/8-inch wide joints into concrete when cutting action will not tear, abrade, or otherwise damage surface and before concrete develops random contraction cracks.
- D. Isolation Joints in Slabs-on-Grade: After removing formwork, install joint-filler strips at slab junctions with vertical surfaces, such as column pedestals, foundation walls, grade beams, and other locations, as indicated.
1. Extend joint-filler strips full width and depth of joint, terminating flush with finished concrete surface unless otherwise indicated.
 2. Terminate full-width joint-filler strips not less than 1/2 inch or more than 1 inch below finished concrete surface where joint sealants, specified in Section 241080 "Joint Sealants," are indicated.
 3. Install joint-filler strips in lengths as long as practicable. Where more than one length is required, lace or clip sections together.
- E. Doweled Joints: Install dowel bars and support assemblies at joints where indicated. Lubricate or asphalt coat one-half of dowel length to prevent concrete bonding to one side of joint.

3.7 VAPOR RETARDERS

- A. Sheet Vapor Retarders: Place, protect, and repair sheet vapor retarder according to ASTM E 1643 and Manufacturer's written instructions.
1. Lap joints 6 inches and seal with Manufacturer's recommended tape.
 2. Seal large penetrations with material recommended by Vapor Retarder Manufacturer.
- B. Granular Course: Cover vapor retarder with granular fill, moisten, and compact with mechanical equipment to elevation tolerances of plus 0 inch or minus 3/4 inch.

3.8 WATERSTOPS

- A. Self-Expanding Strip Waterstops: Install in construction joints and at other locations indicated, according to Manufacturer's written instructions, adhesive bonding, mechanically fastening, and firmly pressing into place. Install in longest lengths practicable.

3.9 CONCRETE PLACEMENT

- A. Before placing concrete, verify that installation of formwork, reinforcement, and embedded items is complete and that required inspections have been performed.
- B. Do not add water to concrete during delivery, at Project site, or during placement unless approved by Owner.
- C. Before test sampling and placing concrete, water may be added at Project site, subject to limitations of ACI 301.
 - 1. Do not add water to concrete after adding high-range water-reducing admixtures to mixture.
- D. Preparation:
 - 1. Remove hardened concrete and foreign materials from inner surface of conveying equipment.
 - 2. Verify that formwork has been completed.
 - 3. Verify that ice and excess water and other foreign material has been removed; reinforcement has been secured in place and cleaned of foreign matter, such as form oil and tags removed; expansion joint material, anchors, and other embedded items have been positioned.
 - 4. Do not place concrete on frozen ground.
 - 5. Preparation of base course for slabs-on-ground:
 - a. Base course shall be well drained and of adequate and uniform load bearing capacity. Minimum in-place density of base course material shall be as required by Contract Documents. Bottom of an un-drained granular base course shall not be lower than adjacent finished grade.
 - b. Base course shall be moist at time of placing concrete to eliminate suction and seal porous material. If necessary, dampen base course material with water in advance of placing concrete. There shall be no standing water on base course surface nor any muddy or soft spots when concrete is placed.
- E. Conveying: Meet requirements of ACI 301 and ACI 304.
- F. Depositing: Meet requirements of ACI 304.
- G. Deposit concrete continuously in one layer or in horizontal layers of such thickness that no new concrete will be placed on concrete that has hardened enough to cause seams or planes of weakness. If a section cannot be placed continuously, provide construction joints as indicated. Deposit concrete to avoid segregation.
 - 1. Deposit concrete in horizontal layers of depth to not exceed formwork design pressures and in a manner to avoid inclined construction joints.
 - 2. Consolidate placed concrete with mechanical vibrating equipment according to ACI 301.
 - 3. Do not use vibrators to transport concrete inside forms. Insert and withdraw vibrators vertically at uniformly spaced locations to rapidly penetrate placed layer and at least 6 inches into preceding layer. Do not insert vibrators into lower layers of concrete that have begun to lose plasticity. At each insertion, limit duration of vibration to time necessary to

consolidate concrete and complete embedment of reinforcement and other embedded items without causing mixture constituents to segregate.

- H. Deposit and consolidate concrete for floors and slabs in a continuous operation, within limits of construction joints, until placement of a panel or section is complete.
 - 1. Consolidate concrete during placement operations so concrete is thoroughly worked around reinforcement and other embedded items and into corners.
 - 2. Maintain reinforcement in position on chairs during concrete placement.
 - 3. Screed slab surfaces with a straightedge and strike off to correct elevations.
 - 4. Slope surfaces uniformly to drains where required.
 - 5. Begin initial floating using bull floats or darbies to form a uniform and open-textured surface plane, before excess bleed-water appears on the surface. Do not further disturb slab surfaces before starting finishing operations.
- I. Segregation:
 - 1. Deposit concrete as nearly as practicable in final position to avoid segregation due to re-handling or flowing.
 - 2. Do not subject concrete to any procedure which will cause segregation.
- J. Consolidation: Meet requirements of ACI 309.
- K. Cold-Weather Placement: Comply with ACI 306.1 and as follows. Protect concrete work from physical damage or reduced strength that could be caused by frost, freezing actions, or low temperatures.
 - 1. When average high and low temperature is expected to fall below 40 deg F for three successive days, maintain delivered concrete mixture temperature within the temperature range required by ACI 301.
 - 2. Do not use frozen materials or materials containing ice or snow. Do not place concrete on frozen sub-grade or on sub-grade containing frozen materials.
 - 3. Do not use calcium chloride, salt, or other materials containing antifreeze agents or chemical accelerators unless otherwise specified and approved in mixture designs.
- L. Hot-Weather Placement: Comply with ACI 301 and as follows:
 - 1. Maintain concrete temperature below 90 deg F at time of placement. Chilled mixing water or chopped ice may be used to control temperature, provided water equivalent of ice is calculated to total amount of mixing water. Using liquid nitrogen to cool concrete is Contractor's option.
 - 2. Fog-spray forms, steel reinforcement, and sub-grade just before placing concrete. Keep sub-grade uniformly moist without standing water, soft spots, or dry areas.
- M. Concreting Underwater: Deposit concrete under water by use of tremie or other acceptable method in a way that fresh concrete enters mass of previously placed concrete from within, causing water to be displaced with minimum disturbance at surface of concrete.
- N. Concrete Placement on Steel Decks:

1. Exercise care during concrete placement on steel decks to prevent concentrated loads or high pile-ups of concrete and to avoid impacts caused by dumping or dropping of concrete on steel decks.
2. Do not use buggies on unprotected areas of deck. If buggies are used to place concrete, furnish and install planked runways to protect deck from damage.
3. Place concrete to elevation indicated on drawings.

3.10 FINISHING FORMED SURFACES

- A. General: Meet requirements of ACI 301-96, Section 5. After removal of forms and repair of surface defects, give surfaces of concrete smooth form finish specified.
- B. Rough-Formed Finish: As-cast concrete texture imparted by form-facing material with tie holes and defects repaired and patched. Remove fins and other projections that exceed specified limits on formed-surface irregularities.
- C. Smooth Form Finish: As-cast concrete texture imparted by form-facing material, arranged in an orderly and symmetrical manner with a minimum of seams. Repair and patch tie-holes and defects. Remove fins completely and other projections that exceed specified limits on formed-surface irregularities. Grout rub exterior surface of all exposed foundation walls.
 1. Apply to concrete surfaces exposed to public view.
- D. Rubbed Finish: Apply the following to smooth-formed finished as-cast concrete where indicated:
 1. Smooth-Rubbed Finish: Not later than one day after form removal, moisten concrete surfaces and rub with carborundum brick or another abrasive until producing a uniform color and texture. Do not apply cement grout other than that created by the rubbing process.
 2. Grout-Cleaned Finish: Wet concrete surfaces and apply grout of a consistency of thick paint to coat surfaces and fill small holes. Mix one part Portland cement to one and one-half parts fine sand with a 1:1 mixture of bonding admixture and water. Add white Portland cement in amounts determined by trial patches so color of dry grout will match adjacent surfaces. Scrub grout into voids and remove excess grout. When grout whitens, rub surface with clean burlap and keep surface damp by fog spray for at least 36 hours.
 3. Cork-Floated Finish: Wet concrete surfaces and apply a stiff grout. Mix one part Portland cement and one part fine sand with a 1:1 mixture of bonding agent and water. Add white Portland cement in amounts determined by trial patches so color of dry grout will match adjacent surfaces. Compress grout into voids by grinding surface. In a swirling motion, finish surface with a cork float.
- E. Related Unformed Surfaces:
 1. At tops of walls, horizontal offsets, and similar unformed surfaces adjacent to formed surfaces, strike off smooth and finish with a texture matching adjacent formed surfaces.
 2. Continue final surface treatment of formed surfaces uniformly across adjacent unformed surfaces unless otherwise indicated.

3.11 STEEL REINFORCEMENT

- A. General: Comply with CRSI's "Manual of Standard Practice" for placing reinforcement.
 - 1. Do not cut or puncture vapor retarder. Repair damage and reseal vapor retarder before placing concrete.
- B. Clean reinforcement of loose rust and mill scale, earth, ice, and other foreign materials that would reduce bond to concrete.
- C. Accurately position, support, and secure reinforcement against displacement. Locate and support reinforcement with bar supports to maintain minimum concrete cover. Do not tack weld crossing reinforcing bars.
 - 1. Weld reinforcing bars according to AWS D1.4, where indicated.
- D. Set wire ties with ends directed into concrete, not toward exposed concrete surfaces.
- E. Install welded wire reinforcement in longest practicable lengths on bar supports spaced to minimize sagging. Lap edges and ends of adjoining sheets at least one mesh spacing. Offset laps of adjoining sheet widths to prevent continuous laps in either direction. Lace overlaps with wire.

3.12 FLATWORK

- A. Joints:
 - 1. Locate joints in slabs-on-ground as required, at minimum meeting requirements of Contract Documents.
 - 2. Cut control/contraction joints meeting requirements of this Section, Drawings and specialty contractors for shrinkage compensating concrete, when applicable.
 - 3. For joints to be subsequently sealed with sealant, provide joints of configuration meeting requirements of Section 241080 - Joint Sealants, for appropriate type sealant.
- B. Edge Forms and Screeds:
 - 1. Set edge forms and intermediate screed strips accurately to produce required elevations and contours in finished surfaces and shall be strong to support screeds.
 - 2. Align concrete surface to contours of screed strips by use of strike-off templates or appropriate compacting type screeds.
 - 3. When formwork is cambered, set screeds to same camber to maintain proper concrete thicknesses.
- C. Consolidation:
 - 1. Thoroughly consolidate concrete in slabs.
 - 2. Use internal vibration:
 - a. Along bulkheads of slabs-on-ground.
 - b. In beams and girders of suspended slabs.

3. Obtain consolidation of flatwork with vibrating bridge screeds, roller pipe screeds or other appropriate means.
4. Consolidate concrete prior to strike-off and do not manipulate surfaces prior to finishing operations.

D. Jointing:

1. Time cutting of saw-cut joints properly with set of concrete.
2. Start cutting as soon as concrete has hardened sufficiently to prevent aggregates from being dislodged by saw.
3. Complete before shrinkage stresses have developed sufficiently to induce cracking.

E. Control Joints: Saw cut control joints as soon as practicable in a timely fashion to eliminate concrete cracking. Control joint width shall be as required for joint sealant, but 1/8 inch minimum, and depth shall be between one-quarter to one-third thickness of slab, except as otherwise indicated on Drawings. Edges of sawn joints shall be straight, uniform, and free of chips, removed aggregate and other like defects.

F. Edging: Tool edges of joints, except at sawn joints, and edges adjoining metal embedments. Provide required configuration and size, providing 1/8 inch maximum radius.

3.13 FLATWORK FINISHES

A. General: Use finishing procedures for flatwork finishing reviewed by Quality Control Service and acceptable to Owner.

B. Selection of Finishes: Provide finishes for concrete flatwork surfaces as follows:

1. Scratch Finish: Surfaces to receive concrete topping to be bonded to base concrete, except as otherwise required.
2. Float Finish: Surfaces to receive trowel finish; surfaces to receive waterproofing, roofing or finish flooring systems with thick-set mortar beds, and surfaces to receive concrete topping over slip sheet.
3. Trowel Finish: Surfaces exposed to view in the completed work, and surfaces to receive floor coverings, finish materials or coatings, except as otherwise required.
4. Trowel Finish: Surfaces to receive polished concrete finish system.
5. Burnished Finish: Surfaces exposed to view in the completed work requiring burnished finish.
6. Fine Broom Finish: Surfaces where tile is to be installed with thin-set mortar systems.
7. Broom Finish: Surfaces of walkways, stair treads and landings, ramps and elsewhere where required.
8. Belted Finish: Surfaces of walkways, stair treads and landings, ramps and elsewhere where required.
9. Nonslip Aggregate Finish: Stair treads and landings, platforms, ramps, sloped surfaces, and elsewhere where required.
10. Dry Shake Floor Hardener.

C. Scratch Finish:

1. Perform initial strike-off.

2. After leveling, roughen surface before final set with stiff brushes, brooms, rakes or other mechanical means, in one direction, as acceptable to concrete topping Manufacturer, with no fractured coarse aggregate.

D. Float Finish: As a minimum, provide float finish as follows:

1. Perform initial strike-off using wet screed and grade markers.
2. Close and straighten using highway straightedge (8 to 12 feet in length) and fill in low spots.
3. After concrete has been placed, struck-off, consolidated, and leveled, do not work concrete further until ready for floating.
4. Begin floating when water sheen has disappeared and when mix has stiffened sufficiently to permit proper float operation.
5. Consolidate surface with power-driven floats of impact type, except in thin sections such as pan slabs. Use of combination float and finish blade on power-driven floats is not permitted. Use hand floating with wood or cork-faced floats in locations inaccessible to power-driven machine.
6. Recheck trueness of surface at this stage with 10 foot straightedge applied at not less than two different angles.
7. Cut down high spots and fill low spots to produce planes checking true under straightedge in any direction.
8. Refloat slab immediately to uniform smooth, granular texture.
9. Adjust flatwork finishing procedures as required to achieve specified flatwork tolerances.

E. Trowel Finish:

1. Give surface float finish as specified, then finish with first troweling, and finally with final trowelings.
2. Adjust finish using highway straightedge (8 to 12 feet in length) to provide required tolerance.
3. As concrete surface further stiffens, as indicated by loss of surface moisture (sheen), perform first troweling after floating to produce uniformly smooth surface which is relatively free of defects but which may still contain some trowel marks. Perform additional trowelings after surface has hardened sufficiently. Final troweling shall be completed when ringing sound is produced as trowel is moved over surface. Use hand troweling in locations inaccessible to power driven trowel machines.
4. Thoroughly consolidate surface by troweling operations.
5. Finished surface shall be free of defects, pinholes, voids, concrete scum and laitance, tool marks and scratches, and dense and uniform in texture and appearance on surfaces intended to be exposed in the completed work or to support floor coverings.
6. Remove defects from concrete to be exposed in the completed work or of magnitude that may show or telegraph through floor covering, by grinding, as applicable. Avoid scratching concrete surfaces to be exposed in the completed work.

F. Burnished Finish:

1. Give surface trowel finish as specified.
2. Continue troweling under pressure to provide a compact, hard, dense, smooth, burned and brilliant lustrous finish to concrete surface, free of tool marks, pinholes, rough spots and other surface defects and blemishes, and uniform in texture and appearance. Provide 3 troweling operations minimum.

G. Fine Broom Finish:

1. Give surface trowel finish as specified.
2. Apply fine transversed scored texture by drawing fine texture synthetic fiber bristle broom as acceptable to Architect, across surface perpendicular to traffic pattern.
3. Texture surface immediately after troweling.
4. Finished surface shall be free of defects, pinholes, voids, concrete scum and laitance, tool marks, and uniform in texture and appearance.

H. Broom Finish:

1. Give surface floated finish as specified.
2. Apply coarse transverse scored texture by drawing medium texture fiber bristle broom as acceptable to Architect, across surface perpendicular to traffic pattern.
3. Texture surface immediately after floating.
4. Finished surface shall be free of concrete scum and laitance, tool marks, and holes and voids, and uniform in texture and appearance.

I. Belted Finish:

1. Give surface float finish as specified.
2. Apply coarse transversed texture by drawing burlap belt across surface perpendicular to traffic pattern.
3. Texture surface immediately after floating.
4. Finish surface shall be free of concrete scum and laitance, tool marks, and holes and voids, and uniform in texture and appearance.

J. Slip-Resistive Finish: Before final floating, apply slip-resistive aggregate or aluminum granule finish where indicated and to concrete stair treads, platforms, and ramps. Apply according to Manufacturer's written instructions and as follows:

1. Uniformly spread 25 lb/100 sq. ft. of dampened slip-resistive aggregate or aluminum granules over surface in one or two applications. Tamp aggregate flush with surface, but do not force below surface.
2. After broadcasting and tamping, apply float finish.
3. After curing, lightly work surface with a steel wire brush or an abrasive stone and water to expose slip-resistive aggregate or aluminum granules.

K. Non-slip Aggregate Finish:

1. Blend nonslip finish aggregate with Portland cement in proportions instructed by aggregate Manufacturer.
2. Give surface float finish as specified.
3. Apply fused aluminum oxide aggregates at rate of 0.25 pounds per square foot minimum or crushed emery aggregate at rate of 0.5 pounds per square foot minimum.
4. Apply approximately two-thirds of blended material for required coverage to surface by method that ensures uniform coverage without segregation.
5. Begin floating immediately after application of first dry shake.
6. After material has been embedded by floating, apply remainder of blended material to surface at right angles to previous application.

7. Second application shall be heavier in any area not sufficiently covered by first application.
8. Follow immediately with second floating.
9. After material has been embedded by two floatings, complete operation with fine broom, float or trowel finish as instructed and recommended by aggregate Manufacturer for nonslip finish.
10. Finished surface shall be free of concrete scum and laitance, and tool marks, and uniform in texture and appearance.

3.14 MISCELLANEOUS CONCRETE ITEMS

- A. Filling In: Fill in holes and openings left in concrete structures after work of other trades is in place unless otherwise indicated. Mix, place, and cure concrete, as specified, to blend with in-place construction. Provide other miscellaneous concrete filling indicated or required to complete the Work.

3.15 FLATWORK TOLERANCES

- A. Elevation Tolerances:

1. General: Overall concrete top surface elevation tolerance shall be within limiting deviation from design surface elevation.
2. Slabs-On-Ground Elevation: Measured surface elevations shall be within 1/4 inch of design surface elevation.
3. Suspended Slabs Elevation: Measured surface elevations, before removal of forms and form supports, shall be within 1/4 inch of design surface elevation.

- B. Flatwork Surface Profile Tolerances - Random Traffic Patterns:

1. General: When traffic patterns across flatwork will be random, not confined to specific paths, flatwork surfaces shall be within limiting flatness, levelness and overall conformance to surface design elevation measured within 24 hours meeting requirements of ASTM E1155.

2. Flatness (Flatness F-Number):

- a. General: Flatwork flatness shall be controlled by Flatness F-Number (F_F) limiting profile of flatwork surface over a distance of 2 feet.

- b. Slabs-On-Grade:

- 1) General - Flat:

Overall Value: **50.**
Minimum Local Value: **40.**

- c. Slabs On Decking:

- 1) General - Flat:

Overall Value: **50.**

Minimum Local Value: **40.**

3. Levelness (Levelness F-Number):
 - a. General: Flatwork levelness shall be controlled by Levelness F-Number (F_L) limiting inclination of slab surface over a distance of 10 feet.
 - b. Slabs-On-Grade:
 - 1) General - Flat:

Overall Value: **24.**
Minimum Local Value: **17.**
 - 2) At non-sloping floor locations.
 - c. Slabs-On-Decking:
 - 1) General - Flat:

Overall Value: **24.**
Minimum Local Value: **17.**
 - 2) At non-sloping floor locations.
4. Hard-steel troweled (3 passes) concrete. No burnishing marks. Finish to ACI 302.1R, Class 5 Floor.

3.16 CURING AND PROTECTION

A. General:

1. Meet recommendations of ACI 308, except as otherwise specified in this Section.
2. Protect freshly deposited concrete from premature drying, hot or cold temperatures, precipitation and mechanical injury.
3. Maintain without drying at relatively constant temperature for period of time necessary for hydration of cement and proper hardening of concrete.
4. Concrete shall not be wetted and dried and wetted.

B. Evaporation Retarder:

1. Protect concrete exposed or subject to rapid moisture evaporation from ambient dry conditions including, but not limited to, hot weather, drying winds, sunlight and heated interior during cold weather, immediately following screeding operation and between finishing operations as applicable. Do not apply to concrete surfaces after final finishing when curing operation starts. Do not use as a curing compound.
2. Apply evaporation retarder, in diluted solution form, uniformly over entire surface of concrete in a two coat continuous operation by spray equipment. Meet instructions of Manufacturer. Protect hardened concrete and other surfaces from retarder.

C. Curing:

1. Formed Surfaces: For concrete placed against forms, prevent moisture loss as follows as minimum:
 - a. Maintain steel forms heated by sun during curing period wet.
 - b. Maintain wood forms in contact with concrete during curing period wet.
 - c. If forms are to be removed during curing period, immediately provide curing materials or methods meeting applicable requirements of this Paragraph as acceptable to Owner.

2. Unformed Surfaces - General: For concrete not in contact with forms, prevent moisture loss using one of following procedures, except as otherwise required:
 - a. Water Curing: Water shall meet requirements of this Section.
 - 1) Ponding or continuous sprinkling.
 - 2) Moisture Retaining Cover, or Absorptive Mat or Fabric:
 - a) Cover concrete surfaces with cover thoroughly saturated with water. Place cover to provide coverage of concrete surfaces and edges, with 24 inch overlap of adjacent cover units and extension beyond edges of concrete. Initially saturate cover with water before placement, not after cover is placed over concrete surfaces. Maintain cover continuously wet with water, in correct placement over concrete and prevent cover from being turned down, exposing concrete, during entire curing period.
 - b) Minimize interruption of curing process, including sawing of control joints and performing floor tolerance measurements. Remove cover only as required for interruption, and then replace cover. Do not remove cover from entire area of concrete.
 - b. Curing Compounds: Curing compounds shall meet requirements of this Section, Part 2.
 - 1) Apply meeting instructions of Manufacturer immediately after any water sheen which may have developed after finishing has disappeared.
 - 2) Do not use on surfaces against which additional concrete or other cementitious finishing materials are to be bonded, over surfaces to receive liquid concrete sealer densifier, waterproofing, floor coverings, finish materials or coatings.

3. Starting: Begin curing within 30 minute maximum after final finishing operation, except as otherwise required.

4. Duration:
 - a. Curing shall continue until cumulative number of consecutive days, during which temperature of air in contact with concrete is above 50 F, has totaled 7 days.
 - b. If high early strength concrete has been used, final curing shall continue for total of 3 days.
 - c. Avoid rapid drying at end of curing period. Rapid drying at end of curing period shall not interfere with subsequent finishes or floor coverings.

5. Concrete floor slab treatments shall meet requirements of this section, Part 2.

D. Protection:

1. During curing period, protect freshly placed concrete from:
 - a. Rain, flowing water, hail, sleet and other like weather.
 - b. Mechanical disturbances, such as load stress, heavy shock or excessive vibration.
 - c. Damage by construction equipment, materials and subsequent construction operations.
2. Do not load self-supporting structures as to overstress concrete.
3. Except as otherwise acceptable to Owner, for flatwork:
 - a. No traffic shall be permitted for 3 days minimum.
 - b. Only light foot traffic shall be permitted after 3 days, up to 7 days minimum.
 - c. No heavy traffic shall be permitted until after 10 days minimum.
 - d. No racking post loads, mezzanine loads and fork lift traffic permitted until after 28 days minimum.

3.17 LIQUID FLOOR TREATMENTS

- A. Penetrating Liquid Floor Treatment: Prepare, apply, and finish penetrating liquid floor treatment according to Manufacturer's written instructions.
 1. Remove curing compounds, sealers, oil, dirt, laitance, and other contaminants and complete surface repairs.
 2. Do not apply to concrete that is less than 28 days' old.
 3. Apply liquid until surface is saturated, scrubbing into surface until a gel forms; rewet; and repeat brooming or scrubbing. Rinse with water; remove excess material until surface is dry. Apply a second coat in a similar manner if surface is rough or porous.
- B. Polished Concrete Floor Treatment: Apply polished concrete finish system to cured and prepared slabs to match accepted mockup.
 1. Machine grind floor surfaces to receive polished finishes level and smooth and to depth required to reveal aggregate to match approved mockup.
 2. Apply penetrating liquid floor treatment for polished concrete in polishing sequence and according to Manufacturer's written instructions, allowing recommended drying time between successive coats.
 3. Continue polishing with progressively finer grit diamond polishing pads to gloss level to match approved mockup.
 4. Control and dispose of waste products produced by grinding and polishing operations.
 5. Neutralize and clean polished floor surfaces.
- C. Sealing Coat: Uniformly apply a continuous sealing coat of curing and sealing compound to hardened concrete by power spray or roller according to Manufacturer's written instructions.

3.18 JOINT FILLING

- A. Prepare, clean, and install joint filler according to Manufacturer's written instructions.
 - 1. Defer joint filling until concrete has aged at least one month. Do not fill joints until construction traffic has permanently ceased.
- B. Remove dirt, debris, saw cuttings, curing compounds, and sealers from joints; leave contact faces of joint clean and dry.
- C. Install semi-rigid joint filler full depth in saw-cut joints and at least 2 inches deep in formed joints. Overfill joint and trim joint filler flush with top of joint after hardening.

3.19 CONCRETE SURFACE REPAIRS

- A. Defective Concrete: Repair and patch defective areas when approved by Owner. Remove and replace concrete that cannot be repaired and patched to Owner's approval.
- B. Patching Mortar: Mix dry-pack patching mortar, consisting of one part Portland cement to two and one-half parts fine aggregate passing a No. 16 sieve, using only enough water for handling and placing.
- C. Refer to Section 240010 "Maintenance of Cast-in-Place Concrete".
- D. Repairing Formed Surfaces: Surface defects include color and texture irregularities, cracks, spalls, air bubbles, honeycombs, rock pockets, fins and other projections on the surface, and stains and other discolorations that cannot be removed by cleaning.
 - 1. Immediately after form removal, cut out honeycombs, rock pockets, and voids more than 1/2 inch in any dimension to solid concrete. Limit cut depth to 3/4 inch. Make edges of cuts perpendicular to concrete surface. Clean, dampen with water, and brush-coat holes and voids with bonding agent. Fill and compact with patching mortar before bonding agent has dried. Fill form-tie voids with patching mortar or cone plugs secured in place with bonding agent.
 - 2. Repair defects on surfaces exposed to view by blending white Portland cement and standard Portland cement so that, when dry, patching mortar will match surrounding color. Patch a test area at inconspicuous locations to verify mixture and color match before proceeding with patching. Compact mortar in place and strike off slightly higher than surrounding surface.
 - 3. Repair defects on concealed formed surfaces that affect concrete's durability and structural performance as determined by Owner.
- E. Repairing Unformed Surfaces: Test unformed surfaces, such as floors and slabs, for finish and verify surface tolerances specified for each surface. Correct low and high areas. Test surfaces sloped to drain for trueness of slope and smoothness; use a sloped template.
 - 1. Repair finished surfaces containing defects. Surface defects include spalls, popouts, honeycombs, rock pockets, crazing and cracks in excess of 0.01 inch wide or that penetrate to reinforcement or completely through unreinforced sections regardless of width, and other objectionable conditions.

2. After concrete has cured at least 14 days, correct high areas by grinding.
 3. Correct localized low areas during or immediately after completing surface finishing operations by cutting out low areas and replacing with patching mortar. Finish repaired areas to blend into adjacent concrete.
 4. Correct other low areas scheduled to receive floor coverings with a repair underlayment. Prepare, mix, and apply repair underlayment and primer according to Manufacturer's written instructions to produce a smooth, uniform, plane, and level surface. Feather edges to match adjacent floor elevations.
 5. Correct other low areas scheduled to remain exposed with a repair topping. Cut out low areas to ensure a minimum repair topping depth of 1/4 inch to match adjacent floor elevations. Prepare, mix, and apply repair topping and primer according to Manufacturer's written instructions to produce a smooth, uniform, plane, and level surface.
 6. Repair defective areas, except random cracks and single holes 1 inch or less in diameter, by cutting out and replacing with fresh concrete. Remove defective areas with clean, square cuts and expose steel reinforcement with at least a 3/4-inch clearance all around. Dampen concrete surfaces in contact with patching concrete and apply bonding agent. Mix patching concrete of same materials and mixture as original concrete except without coarse aggregate. Place, compact, and finish to blend with adjacent finished concrete. Cure in same manner as adjacent concrete.
 7. Repair random cracks and single holes 1 inch or less in diameter with patching mortar. Groove top of cracks and cut out holes to sound concrete and clean off dust, dirt, and loose particles. Dampen cleaned concrete surfaces and apply bonding agent. Place patching mortar before bonding agent has dried. Compact patching mortar and finish to match adjacent concrete. Keep patched area continuously moist for at least 72 hours.
- F. Perform structural repairs of concrete, subject to Owner's approval, using epoxy adhesive and patching mortar.
- G. Repair materials and installation not specified above may be used, subject to Owner's approval.

3.20 EQUIPMENT PADS

- A. General: Provide concrete equipment pads or housekeeping pads for floor mounted equipment, complete with reinforcement and necessary anchors, bolts and like items; normal weight concrete of 4,000 psi minimum compressive strength at 28 day age.
- B. Location: Location of equipment pads shall be as indicated on equipment shop drawings and shall be responsibility of equipment installer.
- C. Configuration: Equipment pads shall be 4 inches high and extend 4 inches beyond base or sole plate profile of equipment.
- D. Anchorage: Where equipment pad is located directly on concrete floor, provide anchorage of concrete equipment pads to structural concrete floor, except as otherwise required for vibration control.
- E. Anchor Bolts: Set anchor bolts and secure each anchor bolt assembly to forms. Sleeves shall be filled with grout, except as otherwise required.

- F. Reinforcement: Reinforce equipment pads with Number 4 reinforcing bars placed at mid-thickness of pad, minimum.

3.21 FIELD QUALITY CONTROL

A. General:

1. Testing and Inspecting: **Owner will engage** a qualified independent testing and inspecting agency to perform field tests and inspections and prepare test reports.
2. Technical personnel performing concrete work quality assurance and control evaluations shall be certified meeting requirements of NICET, and shall be an ACI Concrete Field Testing Technician, Grade I, or meet requirements of ASTM C94.

B. Inspections:

1. Steel reinforcement placement.
2. Steel reinforcement welding.
3. WWF or WWM placement.
4. Headed bolts and studs and steel angles embedded in concrete.
5. Verification of use of required design mixture.
6. Concrete placement, including conveying and depositing.
7. Curing procedures and maintenance of curing temperature.
8. Verification of concrete strength before removal of shores and forms from beams and slabs.
9. Slump tests.
10. Break tests.
11. Mix designs.
12. Structural grout placement.

- C. Acceptance: The concrete floor must be approved by the finish floor Manufacturer or Installer prior to installing floor finishes. Floor Finish Installer and General Contractor assume full responsibility for concrete substrate once floor finishes are applied. Flooring installer must prepare concrete floor as recommended by floor finish Manufacturer prior to installing finish floor materials including, but not limited to, preparation of floor surface for adhesive application over topical coatings or cure and sealing materials already applied. Provide written approval to the Owner that the concrete floor, including all materials applied to the concrete during installation, is approved by the Manufacturer for the finish flooring material to be installed and which adhesive is approved for each application.

- D. Concrete Tests: Testing of composite samples of fresh concrete obtained according to ASTM C 172 shall be performed according to the following requirements:

1. Testing Frequency: Obtain one composite sample for each day's pour of each concrete mixture exceeding 5 cu. yd., but less than 25 cu. yd, plus one set for each additional 50 cu. yd. or fraction thereof.
2. Testing Frequency: Obtain at least one composite sample for each 100 cu. yd. or fraction thereof of each concrete mixture placed each day.

- a. When frequency of testing will provide fewer than five compressive-strength tests for each concrete mixture, testing shall be conducted from at least five randomly selected batches or from each batch if fewer than five are used.
3. Slump: ASTM C 143; one test at point of placement for each composite sample, but not less than one test for each day's pour of each concrete mixture. Perform additional tests when concrete consistency appears to change.
4. Air Content: ASTM C 231, pressure method, for normal-weight concrete; one test for each composite sample, but not less than one test for each day's pour of each concrete mixture.
5. Concrete Temperature: ASTM C 1064; one test hourly when air temperature is 40 deg F and below and when 80 deg F and above, and one test for each composite sample.
6. Unit Weight: ASTM C 567, fresh unit weight of structural lightweight concrete; one test for each composite sample, but not less than one test for each day's pour of each concrete mixture.
7. Compression Test Specimens: ASTM C 31.
 - a. Cast and laboratory cure two sets of two standard cylinder specimens for each composite sample.
 - b. Cast and field cure two sets of two standard cylinder specimens for each composite sample.
8. Compressive-Strength Tests: ASTM C 39; test one set of two laboratory-cured specimens at 7 days and one set of two specimens at 28 days.
 - a. Test one set of two field-cured specimens at 7 days and one set of two specimens at 28 days.
 - b. A compressive-strength test shall be the average compressive strength from a set of two specimens obtained from same composite sample and tested at age indicated.
9. When strength of field-cured cylinders is less than 85 percent of companion laboratory-cured cylinders, Contractor shall evaluate operations and provide corrective procedures for protecting and curing in-place concrete.
10. Strength of each concrete mixture will be satisfactory if every average of any three consecutive compressive-strength tests equals or exceeds specified compressive strength and no compressive-strength test value falls below specified compressive strength by more than 500 psi.
11. Test results shall be reported in writing to Owner, concrete Manufacturer, and Contractor within 48 hours of testing. Reports of compressive-strength tests shall contain Project identification name and number, date of concrete placement, name of concrete testing and inspecting agency, location of concrete batch in Work, design compressive strength at 28 days, concrete mixture proportions and materials, compressive breaking strength, and type of break for both 7- and 28-day tests.
12. Non-destructive Testing: Impact hammer, sonoscope, or other nondestructive device may be permitted by Owner but will not be used as sole basis for approval or rejection of concrete.
13. Additional Tests: Testing and inspecting agency shall make additional tests of concrete when test results indicate that slump, air entrainment, compressive strengths, or other requirements have not been met, as directed by Owner. Testing and inspecting agency may conduct tests to determine adequacy of concrete by cored cylinders complying with ASTM C 42 or by other methods as directed by Owner.

14. Additional testing and inspecting, at Contractor's expense, will be performed to determine compliance of replaced or additional work with specified requirements.
15. Correct deficiencies in the Work at no cost to Owner that test reports and inspections indicate.

E. Measure floor and slab flatness and levelness according to ASTM E 1155 within 24 hours of finishing.

F. Welding Qualifications: Verify qualifications and test records of welding procedures and personnel.

3.22 PROTECTION OF LIQUID FLOOR TREATMENTS

A. Protect liquid floor treatment from damage and wear during the remainder of construction period. Use protective methods and materials, including temporary covering, recommended in writing by liquid floor treatments installer.

3.23 ADJUSTING AND CLEANING

A. Repairing Formed Surfaces:

1. Removal: After forms have been stripped, remove concrete which is not formed as required, which is out of alignment or level beyond specified tolerances, or which shows defective surface that cannot be properly repaired or patched. Submit to Owner, in writing, remedial procedures for review prior to beginning work.
2. In areas of honeycombed, spalled or otherwise damaged concrete, repair and patch as specified in this Article, if depth of defective concrete does not extend past centerline of any exposed reinforcement. If depth of defective concrete extends past centerline of any exposed reinforcement, notify Owner and submit, in writing, remedial procedures for review prior to beginning work.
3. Repairing and Patching:
 - a. Patch tie-holes and repair defective areas immediately after form removal.
 - b. Defective Areas:
 - 1) Remove honeycombed and other defective concrete on vertical surfaces that has defects more than 1/2 inch in any plane direction and depths greater than or equal to 3/4 inch.
 - 2) If chipping is necessary, edges shall be perpendicular to face or slightly undercut. No feather edges are permitted.
 - 3) Dampen area to be patched and area of 6 inches minimum width surrounding to prevent absorption of water from patching mortar.
 - 4) Mix bond coat of approximately 1 part neat Portland cement to 1 part fine sand passing Number 30 mesh sieve, and bonding admixture and water to consistency of thick cream. Ratio of bonding admixture and water shall meet instructions of bonding admixture Manufacturer.
 - 5) Make patching mixture of same material and of approximately same proportions as used for concrete, except omit coarse aggregate and use mortar that consists of not more than 1 part cement to 2-1/2 parts sand by damp loose volume.

- 6) Substitute white Portland cement for part of gray Portland cement on exposed concrete in order to produce color matching color of surrounding concrete, as determined by trial patch.
- 7) Add only quantity of mixing water necessary for handling and placing.
- 8) Mix patching mortar in advance and allow to stand with frequent manipulation with trowel, without addition of water, until mortar has reached stiffest consistency to permit placing.
- 9) After surface water has evaporated from area to be patched, brush bond coat into surface.
- 10) When bond coat begins to lose water sheen, apply premixed patching mortar.
- 11) Thoroughly consolidate mortar into place and strike off to leave patch slightly higher than surrounding surface.
- 12) To permit initial shrinkage, leave mortar undisturbed for one hour minimum before being finally finished.
- 13) Keep patched area damp for seven days.
- 14) Do not use metal tools in finishing patch in formed surface which will be exposed.

c. Tie-Holes: After cleaning and thoroughly dampening, fill tie-holes solid with patching mortar, except as otherwise required for exposed concrete.

d. Proprietary Patches:

- 1) Proprietary compounds for adhesion or for patching ingredients or mortar may be used in place of or in addition to specified patching procedures when color match to adjacent concrete is not required, such as concrete not exposed to view in completed work.
- 2) Use, mix, place and cure compounds and related mixtures meeting instructions and recommendations of compound Manufacturer.

B. Out of Tolerance Flatwork:

1. Procedures: Prior to construction, submit for acceptance by Owner procedures proposed for correcting any flatness or levelness defects in areas of work. Correction of work shall be only by direction of Owner.
2. Tolerances: Floor sections shall meet all minimum tolerance levels specified.

a. Slab-On-Ground: Slab-on-ground sections which fail to meet one or both minimum F-Number tolerance levels shall be either ground to tolerance or removed and replaced. If quantity of grinding of flatwork for defined traffic patterns exceeds 15 percent of respective pathway length, replace slab. Filling of low spots will not be permitted under any circumstances.

- 1) Minimum area in any section which shall be considered for replacement shall be that which is bounded by construction or control joints.
- 2) Correct profile defects only by grinding with 10 inch minimum diamond impregnated disk.

b. Suspended Slabs: Structurally supported flatwork sections which fail to meet minimum tolerance levels shall be filled using a topping cementitious material as required to bring finished surface within minimum tolerance levels.

- 1) Minimum area in any section which shall be considered for repair shall be as follows:
 - a) Failure to meet minimum Flatness F-Number (F_F): An area bounded by column lines, such as one bay, or half-column lines, such as one-quarter bay.
 - b) Failure to meet minimum Levelness F-Number (F_L): An area bounded by column lines, such as one bay.
 - c) Failure to meet minimum Elevation Tolerance: An area bounded by column lines, such as one bay.
 - 2) Any topping used shall have been previously accepted for this use by Owner.
- c. Repaired Surfaces: Repaired surfaces shall meet minimum requirements specified for original work.
- C. Reinforcing Fiber Concrete: Provide surfaces of reinforcing fiber concrete to be exposed in the completed work or covered with another material directly bonded to concrete free from fibers. Remove portions of fibers which project above or lie on surface of concrete. Do not damage or deface concrete.
- D. Metal Surface Cleaning: Remove all traces of concrete from metal surfaces, including exposed surfaces of embedments, gratings, drains and like items. Drains and like items shall be operative.

** END OF SECTION **

**SECTION 240030
UNIT MASONRY**

PART 1 - GENERAL

1.1 RELATED DOCUMENTS

- A. Drawings and general provisions of the Contract, including General and Supplementary Conditions and Division 01 Specification Sections, apply to this Section.

1.2 SUMMARY

A. Section Includes:

1. Concrete masonry units.
2. Decorative concrete masonry units.
3. Mortar and grout.
4. Steel reinforcing bars.
5. Masonry joint reinforcement.
6. Ties and anchors.
7. Embedded flashing.
8. Miscellaneous masonry accessories.
9. Cavity-wall insulation.

B. Related Sections:

1. Section 240010 "Cast-in-Place Concrete" for installing dovetail slots for masonry anchors.
2. Section 240040 "Cast Stone Masonry" for furnishing cast stone trim.

1.3 DEFINITIONS

- A. CMU(s): Concrete masonry unit(s).
- B. Reinforced Masonry: Masonry containing reinforcing steel in grouted cells.

1.4 PERFORMANCE REQUIREMENTS

- A. Provide structural unit masonry that develops indicated net-area compressive strengths at 28 days.
 1. Determine net-area compressive strength of masonry from average net-area compressive strengths of masonry units and mortar types (unit-strength method) according to Tables 1 and 2 in ACI 530.1/ASCE 6/TMS 602.
 2. Determine net-area compressive strength of masonry by testing masonry prisms according to ASTM C 1314.

1.5 PRECONSTRUCTION TESTING

- A. Preconstruction Testing Service: **Owner will engage** a qualified independent testing agency to perform preconstruction testing indicated below. Retesting of materials that fail to comply with specified requirements shall be done at Contractor's expense.
 - 1. Concrete Masonry Unit Test: For each type of unit required, according to ASTM C 140 for compressive strength.
 - 2. Mortar Test (Property Specification): For each mix required, according to ASTM C 109 for compressive strength, ASTM C 1506 for water retention, and ASTM C 91 for air content.
 - 3. Mortar Test (Property Specification): For each mix required, according to ASTM C 780 for compressive strength.
 - 4. Grout Test (Compressive Strength): For each mix required, according to ASTM C 1019.
 - 5. Prism Test: For each type of construction required, according to ASTM C 1314.

1.6 ACTION SUBMITTALS

- A. Product Data: For each type of product indicated.
- B. Shop Drawings: For the following:
 - 1. Masonry Units: Show sizes, profiles, coursing, and locations of special shapes.
 - 2. Reinforcing Steel: Detail bending and placement of unit masonry reinforcing bars. Comply with ACI 315, "Details and Detailing of Concrete Reinforcement." Show elevations of reinforced walls.
- C. Samples for Verification: For each type and color of the following:
 - 1. Exposed and Decorative CMUs.
 - 2. Pigmented and colored-aggregate mortar. Make Samples using same sand and mortar ingredients to be used on Project.
 - 3. Weep holes and vents.
 - 4. Accessories embedded in masonry.

1.7 INFORMATIONAL SUBMITTALS

- A. List of Materials Used in Constructing Mockups: List generic product names together with manufacturers, manufacturers' product names, model numbers, lot numbers, batch numbers, source of supply, and other information as required to identify materials used. Include mix proportions for mortar and grout and source of aggregates.
 - 1. Submittal is for information only.
- B. Qualification Data: For testing agency.
- C. Material Certificates: For each type and size of the following:
 - 1. Masonry units.

- a. Include data on material properties and material test reports substantiating compliance with requirements.
 - b. For masonry units, include data and calculations establishing average net-area compressive strength of units.
 - 2. Cementitious materials. Include brand, type, and name of manufacturer.
 - 3. Pre-blended, dry mortar mixes. Include description of type and proportions of ingredients.
 - 4. Grout mixes. Include description of type and proportions of ingredients.
 - 5. Reinforcing bars.
 - 6. Joint reinforcement.
 - 7. Anchors, ties, and metal accessories.
- D. Mix Designs: For each type of mortar and grout. Include description of type and proportions of ingredients.
- 1. Include test reports for mortar mixes required to comply with property specification. Test according to ASTM C 109 for compressive strength, ASTM C 1506 for water retention, and ASTM C 91 for air content.
 - 2. Include test reports, according to ASTM C 1019, for grout mixes required to comply with compressive strength requirement.
- E. Statement of Compressive Strength of Masonry: For each combination of masonry unit type and mortar type, provide statement of average net-area compressive strength of masonry units, mortar type, and resulting net-area compressive strength of masonry determined according to Tables 1 and 2 in ACI 530.1/ASCE 6/TMS 602.
- F. Cold-Weather and Hot-Weather Procedures: Detailed description of methods, materials, and equipment to be used to comply with requirements.

1.8 QUALITY ASSURANCE

- A. Testing Agency Qualifications: Qualified according to ASTM C 1093 for testing indicated.
- B. Source Limitations for Masonry Units: Obtain exposed masonry units of a uniform texture and color, or a uniform blend within the ranges accepted for these characteristics, from single source from single manufacturer for each product required.
- C. Source Limitations for Mortar Materials: Obtain mortar ingredients of a uniform quality, including color for exposed masonry, from single manufacturer for each cementitious component and from single source or producer for each aggregate.
- D. Masonry Standard: Comply with ACI 530.1/ASCE 6/TMS 602 unless modified by requirements in the Contract Documents.
- E. Sample Panels: Build sample panels to verify selections made under sample submittals and to demonstrate aesthetic effects.

1. Build sample panels for typical exterior and interior walls in sizes approximately 48 inches long by 48 inches high by full thickness. Include all masonry accessories in wall construction for complete wall assembly.
 2. Where masonry is to match existing, erect panels adjacent and parallel to existing surface.
 3. Clean one-half of exposed faces of panels with masonry cleaner indicated.
 4. Protect approved sample panels from the elements with weather-resistant membrane.
 5. Approval of sample panels is for color, texture, and blending of masonry units; relationship of mortar and sealant colors to masonry unit colors; tooling of joints; aesthetic qualities of workmanship; and other material and construction qualities specifically approved by Owner in writing.
- F. Mockups: Build mockups to verify selections made under sample submittals and to demonstrate aesthetic effects and set quality standards for materials and execution.
1. Build mockups for typical exterior and interior walls in sizes approximately 48 inches long by 48 inches high by full thickness, including face and backup wythes and accessories.
 - a. Include a sealant-filled joint at least 16 inches long in each wall mockup.
 - b. Include lower corner of window opening. Make opening approximately 12 inches wide by 16 inches high.
 - c. Include through-wall flashing installed for a 24-inch length in corner of exterior wall mockup approximately 16 inches down from top of mockup, with a 12-inch length of flashing left exposed to view (omit masonry above half of flashing).
 - d. Include air/water/vapor barrier, veneer anchors, flashing, cavity drainage material, and weep holes in exterior masonry-veneer wall mockup.
 - e. Include each type of masonry in exterior wall mockup representing finish wall similar to building elevation design.
 2. Where masonry is to match existing, erect mockups adjacent and parallel to existing surface.
 3. Clean one-half of exposed faces of mockups with masonry cleaner as indicated.
 4. Protect accepted mockups from the elements with weather-resistant membrane.
 5. Approval of mockups is for color, texture, and blending of masonry units; relationship of mortar and sealant colors to masonry unit colors; tooling of joints; and aesthetic qualities of workmanship.
 - a. Approval of mockups is also for other material and construction qualities specifically approved by Owner in writing.
 6. Approved mockups may become part of the completed Work if undisturbed at time of Substantial Completion.

1.9 DELIVERY, STORAGE, AND HANDLING

- A. Store masonry units on elevated platforms in a dry location. If units are not stored in an enclosed location, cover tops and sides of stacks with waterproof sheeting, securely tied. If units become wet, do not install until they are dry.

- B. Store cementitious materials on elevated platforms, under cover, and in a dry location. Do not use cementitious materials that have become damp.
- C. Store aggregates where grading and other required characteristics can be maintained and contamination avoided.
- D. Deliver pre-blended, dry mortar mix in moisture-resistant containers designed for use with dispensing silos. Store pre-blended, dry mortar mix in delivery containers on elevated platforms, under cover, and in a dry location or in covered weatherproof dispensing silos.
- E. Store masonry accessories, including metal items, to prevent corrosion and accumulation of dirt and oil.

1.10 PROJECT CONDITIONS

- A. Protection of Masonry: During construction, cover tops of walls, projections, and sills with waterproof sheeting at end of each day's work. Cover partially completed masonry when construction is not in progress.
 - 1. Extend cover a minimum of 24 inches down both sides of walls and hold cover securely in place.
 - 2. Where one wythe of multiwythe masonry walls is completed in advance of other wythes, secure cover a minimum of 24 inches down face next to unconstructed wythe and hold cover in place.
- B. Do not apply uniform floor or roof loads for at least 12 hours and concentrated loads for at least three days after building masonry walls or columns.
- C. Stain Prevention: Prevent grout, mortar, and soil from staining the face of masonry to be left exposed or painted. Immediately remove grout, mortar, and soil that come in contact with such masonry.
 - 1. Protect base of walls from rain-splashed mud and from mortar splatter by spreading coverings on ground and over wall surface.
 - 2. Protect sills, ledges, and projections from mortar droppings.
 - 3. Protect surfaces of window and door frames, as well as similar products with painted and integral finishes, from mortar droppings.
 - 4. Turn scaffold boards near the wall on edge at the end of each day to prevent rain from splashing mortar and dirt onto completed masonry.
- D. Cold-Weather Requirements: Do not use frozen materials or materials mixed or coated with ice or frost. Do not build on frozen substrates. Remove and replace unit masonry damaged by frost or by freezing conditions. Comply with cold-weather construction requirements contained in ACI 530.1/ASCE 6/TMS 602.
 - 1. Cold-Weather Cleaning: Use liquid cleaning methods only when air temperature is 40 deg F and higher and will remain so until masonry has dried, but not less than seven days after completing cleaning.

- E. Hot-Weather Requirements: Comply with hot-weather construction requirements contained in ACI 530.1/ASCE 6/TMS 602.

PART 2 - PRODUCTS

2.1 MASONRY UNITS, GENERAL

- A. Defective Units: Referenced masonry unit standards may allow a certain percentage of units to contain chips, cracks, or other defects exceeding limits stated in the standard. Do not use units where such defects will be exposed in the completed Work.
- B. Fire-Resistance Ratings: Where indicated, provide units that comply with requirements for fire-resistance ratings indicated as determined by testing according to ASTM E 119, by equivalent masonry thickness, or by other means, as acceptable to authorities having jurisdiction.

2.2 CONCRETE MASONRY UNITS

- A. Shapes: Provide shapes indicated and as follows, with exposed surfaces matching exposed faces of adjacent units unless otherwise indicated.
 - 1. Provide special shapes for lintels, corners, jambs, sashes, movement joints, headers, bonding, and other special conditions.
 - 2. Provide bullnose units for outside corners unless otherwise indicated.
- B. Integral Water Repellent: Provide units made with integral water repellent for exposed units.
 - 1. Integral Water Repellent: Liquid polymeric, integral water-repellent admixture that does not reduce flexural bond strength. Units made with integral water repellent, when tested according to ASTM E 514 as a wall assembly made with mortar containing integral water-repellent manufacturer's mortar additive, with test period extended to 24 hours, shall show no visible water or leaks on the back of test specimen.
 - a. Products: Subject to compliance with requirements, available products that may be incorporated into the Work include, but are not limited to, the following:
 - 1) ACM Chemistries; RainBloc.
 - 2) BASF Aktiengesellschaft; Rheopel Plus.
 - 3) Grace Construction Products, W. R. Grace & Co. - Conn.; Dry-Block.
- C. CMUs: ASTM C 90.
 - 1. Unit Compressive Strength: Provide units with minimum average net-area compressive strength of 2150 psi.
 - 2. Density Classification: Medium weight unless otherwise indicated.
 - 3. Size (Width): Manufactured to the following dimensions:
 - a. 4" nominal; 3 5/8" actual.
 - b. 6" nominal; 5 5/8" actual.
 - c. 8" nominal; 7 5/8" actual.

- d. 12" nominal; 11 5/8" actual.
- 4. Exposed Faces: Provide color and texture matching the range represented by Owner's sample.
- D. Decorative CMUs: ASTM C 90.
 - 1. Unit Compressive Strength: Provide units with minimum average net-area compressive strength of 2150 psi.
 - 2. Density Classification: Medium weight.
 - 3. Size (Width): Manufactured to dimensions specified in "CMUs" Paragraph.
 - 4. Pattern and Texture:
 - a. Standard pattern, **ground-face** finish. Match Owner's samples.
 - b. Standard pattern, **split-face** finish. Match Owner's samples.
 - 5. Colors (Basis-of-Design Products):
 - a. **Color 1:** Nitterhouse Masonry Products, Ground Face CMU, **A18** with sealer. Nitterhouse Masonry Products, Split Face CMU, **A18**.
 - b. **Color 2:** Nitterhouse Masonry Products, Ground Face CMU, **J12** with sealer.
 - c. Refer to Architectural Drawings for designations of each masonry color type on Building Elevations.

2.3 CONCRETE AND MASONRY LINTELS

- A. General: Provide one of the following:
- B. Concrete Lintels: ASTM C 1623, matching CMUs in color, texture, and density classification; and with reinforcing bars indicated. Provide lintels with net-area compressive strength not less than CMUs.
- C. Concrete Lintels: Precast or formed-in-place concrete lintels complying with requirements in Section 240010 "Cast-in-Place Concrete," and with reinforcing bars indicated.
- D. Masonry Lintels: Prefabricated or built-in-place masonry lintels made from bond beam CMUs with reinforcing bars placed as indicated and filled with coarse grout. Cure precast lintels before handling and installing. Temporarily support built-in-place lintels until cured.

2.4 MORTAR AND GROUT MATERIALS

- A. Portland Cement: ASTM C 150, Type I, except Type III may be used for cold-weather construction. Provide natural color or white cement as required to produce mortar color indicated.
- B. Hydrated Lime: ASTM C 207, Type S.
- C. Portland Cement-Lime Mix: Packaged blend of portland cement and hydrated lime containing no other ingredients.

- D. Mortar Pigments: Natural and synthetic iron oxides and chromium oxides, compounded for use in mortar mixes and complying with ASTM C 979. Use only pigments with a record of satisfactory performance in masonry mortar.
1. Products: Subject to compliance with requirements, available products that may be incorporated into the Work include, but are not limited to, the following:
 - a. Davis Colors; True Tone Mortar Colors.
 - b. Lanxess Corporation; Bayferrox Iron Oxide Pigments.
 - c. Solomon Colors, Inc.; SGS Mortar Colors.
- E. Colored Cement Product: Packaged blend made from portland cement and hydrated lime and mortar pigments, all complying with specified requirements, and containing no other ingredients.
1. Colored Portland Cement-Lime Mix:
 - a. Products: Subject to compliance with requirements, available products that may be incorporated into the Work include, but are not limited to, the following:
 - 1) Capital Materials Corporation; Riverton Portland Cement Lime Custom Color.
 - 2) Holcim (US) Inc.; Rainbow Mortamix Custom Color Cement/Lime.
 - 3) Lafarge North America Inc.; Eaglebond Portland & Lime.
 - 4) Lehigh Cement Company; Lehigh Custom Color Portland/Lime Cement.
 2. Formulate blend as required to produce color selected by Owner or, if not indicated, as selected by Owner from manufacturer's standard colors.
 3. Pigments shall not exceed 10 percent of portland cement by weight.
- F. Aggregate for Mortar: ASTM C 144.
1. For mortar that is exposed to view, use washed aggregate consisting of natural sand or crushed stone.
 2. For joints less than 1/4 inch thick, use aggregate graded with 100 percent passing the No. 16 sieve.
 3. White-Mortar Aggregates: Natural white sand or crushed white stone.
 4. Colored-Mortar Aggregates: Natural sand or crushed stone of color necessary to produce required mortar color.
- G. Aggregate for Grout: ASTM C 404.
- H. Cold-Weather Admixture: Non-chloride, noncorrosive, accelerating admixture complying with ASTM C 494, Type C, and recommended by manufacturer for use in masonry mortar of composition indicated.
1. Products: Subject to compliance with requirements, available products that may be incorporated into the Work include, but are not limited to, the following:
 - a. Euclid Chemical Company (The); Accelguard 80.
 - b. Grace Construction Products, W. R. Grace & Co. - Conn.; Morset.

- c. Sonneborn Products, BASF Aktiengesellschaft; Trimix-NCA.
- I. Water-Repellent Admixture: Liquid water-repellent mortar admixture intended for use with CMUs containing integral water repellent by same manufacturer.
 - 1. Products: Subject to compliance with requirements, available products that may be incorporated into the Work include, but are not limited to, the following:
 - a. ACM Chemistries; RainBloc for Mortar.
 - b. BASF Aktiengesellschaft; Rheopel Mortar Admixture.
 - c. Grace Construction Products, W. R. Grace & Co. - Conn.; Dry-Block Mortar Admixture.
 - J. Water: Potable.

2.5 REINFORCEMENT

- A. Uncoated Steel Reinforcing Bars: ASTM A 615 or ASTM A 996, Grade 60.
- B. Masonry Joint Reinforcement, General: ASTM A 951.
 - 1. Interior Walls: Hot-dip galvanized, carbon steel.
 - 2. Exterior Walls: Hot-dip galvanized, carbon steel.
 - 3. Wire Size for Side Rods: 0.148-inch diameter.
 - 4. Wire Size for Cross Rods: 0.148-inch diameter.
 - 5. Wire Size for Veneer Ties: 0.187-inch diameter.
 - 6. Spacing of Cross Rods, Tabs, and Cross Ties: Not more than 16 inches o.c.
 - 7. Provide in lengths of not less than 10 feet, with prefabricated corner and tee units.
- C. Masonry Joint Reinforcement for Single-Wythe Masonry: Either ladder or truss type with single pair of side rods.
- D. Masonry Joint Reinforcement for Multiwythe Masonry:
 - 1. Adjustable (two-piece) type, either ladder or truss design, with one side rod at each face shell of backing wythe and with separate adjustable ties with pintle-and-eye connections having a maximum adjustment of 1-1/4 inches. Size ties to extend at least halfway through facing wythe but with at least 5/8-inch cover on outside face. Ties have hooks or clips to engage a continuous horizontal wire in the facing wythe.

2.6 TIES AND ANCHORS

- A. Materials: Provide ties and anchors specified in this article that are made from materials that comply with the following unless otherwise indicated.
 - 1. Hot-Dip Galvanized, Carbon-Steel Wire: ASTM A 82; with ASTM A 153, Class B-2 coating.
- B. Adjustable truss and ladder ties for connecting masonry veneer to masonry backup.

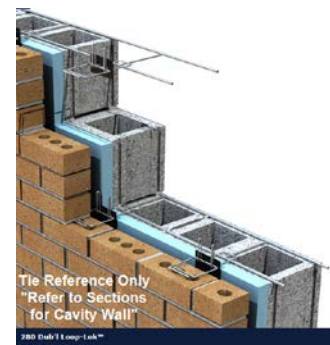

1. Double loop lock adjustable hot-dip galvanized reinforcement with 2-1/4-inch of vertical adjustability and 3/16-inch heavy duty rods.
 - a. Products: Subject to compliance available products that may be incorporated into the Work include, but are not limited to, the following:
 1. Hohmann & Barnard 280 Dub'l-Lok.

2.7 MISCELLANEOUS ANCHORS

- A. Unit Type Inserts in Concrete: Cast-iron or malleable-iron wedge-type inserts.
- B. Dovetail Slots in Concrete: Furnish dovetail slots with filler strips fabricated from 0.034-inch, galvanized steel sheet.
- C. Anchor Bolts: L-shaped steel bolts complying with ASTM A 307, Grade A (ASTM F 568M, Property Class 4.6); with ASTM A 563 hex nuts and, where indicated, flat washers; hot-dip galvanized to comply with ASTM A 153, Class C; of dimensions indicated.
- D. Post-installed Anchors: Torque-controlled expansion anchors or chemical anchors.
 1. Load Capacity: Capable of sustaining, without failure, a load equal to six times the load imposed when installed in unit masonry and four times the load imposed when installed in concrete, as determined by testing according to ASTM E 488, conducted by a qualified independent testing agency.
 2. Material for Interior Locations: Carbon-steel components zinc plated to comply with ASTM B 633 or ASTM F 1941, Class Fe/Zn 5 unless otherwise indicated.
 3. Material for Exterior Locations and Where Stainless Steel Is Indicated: Alloy Group 2 (A4) stainless-steel bolts, ASTM F 593, and nuts, ASTM F 594.

2.8 EMBEDDED FLASHING MATERIALS

- A. Flexible Flashing: Use one of the following unless otherwise indicated:
 1. **EPDM Flashing:** Sheet flashing product made from ethylene-propylene-diene terpolymer, complying with ASTM D 4637, 0.040 inch thick.
 - a. Products: Subject to compliance with requirements, available products that may be incorporated into the Work include, but are not limited to, the following:
 - 1) Carlisle Coatings & Waterproofing; Pre-Kleened EPDM Thru-Wall Flashing.
 - 2) Firestone Specialty Products; FlashGuard.
 - 3) Heckmann Building Products Inc.; No. 81 EPDM Thru-Wall Flashing.
 - 4) Hohmann & Barnard, Inc.; Epra-Max EPDM Thru-Wall Flashing.
 - 5) Sandell Manufacturing Co., Inc.; EPDM Flashing.
- B. Adhesives, Primers, and Seam Tapes for Flashings: Flashing manufacturer's standard products or products recommended by flashing manufacturer for bonding flashing sheets to each other and to substrates.

- C. Pre-molded end dams at all flashing ends and pre-molded corners at all building corners.

2.9 EMBEDDED FLASHING MATERIALS

- A. Metal Flashing: Fabricate from the following metal:

1. Pre-formed **Stainless Steel**: Seal all drip strip joints.
2. Fabricate metal drip strip from sheet metal indicated above. Extend at least 3 inches into wall and ½ inch out from wall, with a hemmed outer edge bent down 30 degrees.

2.10 MISCELLANEOUS MASONRY ACCESSORIES

- A. Compressible Filler: Pre-molded filler strips complying with ASTM D 1056, Grade 2A1; compressible up to 35 percent; of width and thickness indicated; formulated from urethane or PVC.
- B. Pre-formed Control Joint Gaskets: Made from styrene-butadiene-rubber compound, complying with ASTM D 2000, Designation M2AA-805 and designed to fit standard sash block and to maintain lateral stability in masonry wall; size and configuration as indicated.
- C. Bond-Breaker Strips: Asphalt-saturated, organic roofing felt complying with ASTM D 226, Type I (No. 15 asphalt felt).
- D. Weep/Vent Products: Use the following unless otherwise indicated:
 1. Cellular Plastic Weep/Vent: One-piece, flexible extrusion made from UV-resistant polypropylene copolymer, full height and width of head joint and depth 1/8 inch less than depth of outer wythe, in color selected from manufacturer's standard.
 - a. Products: Subject to compliance with requirements, available products that may be incorporated into the Work include, but are not limited to, the following:
 - 1) Advanced Building Products Inc.; Mortar Maze weep vent.
 - 2) Blok-Lok Limited; Cell-Vent.
 - 3) Dayton Superior Corporation, Dur-O-Wal Division; Cell Vents.
 - 4) Heckmann Building Products Inc.; No. 85 Cell Vent.
 - 5) Hohmann & Barnard, Inc.; Quadro-Vent.
 - 6) Wire-Bond; Cell Vent.
- E. Cavity Drainage Material: Free-draining mesh, made from polymer strands that will not degrade within the wall cavity.
 1. Products: Subject to compliance with requirements, available products that may be incorporated into the Work include, but are not limited to, the following:
 - a. Advanced Building Products Inc.; Mortar Break II.
 - b. Archovations, Inc.; CavClear Masonry Mat.
 - c. Dayton Superior Corporation, Dur-O-Wal Division; Polytite MortarStop.
 - d. Mortar Net USA, Ltd.; Mortar Net.

2. Provide one of the following configurations:
 - a. Strips, full-depth of cavity and 10 inches high, with dovetail shaped notches 7 inches deep that prevent clogging with mortar droppings.
 - b. Strips, not less than 1-1/2 inches thick and 10 inches high, with dimpled surface designed to catch mortar droppings and prevent weep holes from clogging with mortar.
 - c. Sheets or strips full depth of cavity and installed to full height of cavity.
 - d. Sheets or strips not less than 1 inch thick and installed to full height of cavity with additional strips 4 inches high at weep holes and thick enough to fill entire depth of cavity and prevent weep holes from clogging with mortar.

F. Reinforcing Bar Positioners: Wire units designed to fit into mortar bed joints spanning masonry unit cells and hold reinforcing bars in center of cells. Units are formed from 0.148-inch steel wire, hot-dip galvanized after fabrication. Provide units designed for number of bars indicated.

1. Products: Subject to compliance with requirements, available products that may be incorporated into the Work include, but are not limited to, the following:
 - a. Dayton Superior Corporation, Dur-O-Wal Division; D/A 810, D/A 812 or D/A 817.
 - b. Heckmann Building Products Inc.; No. 376 Rebar Positioner.
 - c. Hohmann & Barnard, Inc.; #RB or #RB-Twin Rebar Positioner.
 - d. Wire-Bond; O-Ring or Double O-Ring Rebar Positioner.

2.11 CAVITY-WALL INSULATION

- A. Extruded-Polystyrene Board Insulation with Increased R-Value: ASTM C 578, Type IV, but with an aged thermal resistance (R-value) for 1-inch thickness of **5.6** deg F x h x sq. ft./Btu at 75 deg F at 5 years; closed-cell product with a carbon-black filler and extruded with an integral skin and ship lap edges.
- B. Adhesive: Type recommended by insulation board manufacturer for application indicated.

2.12 FLUID APPLIED MEMBRANE AIR, WATER, AND VAPOR BARRIER

- A. Single component, fluid trowel applied, synthetic rubber adhesive non-permeable air, vapor, and rain barrier membrane, self sealing.
 1. Basis-of-Design Product: **Henry Air-Bloc 21** fluid trowel applied air, vapor, and rain barrier.
 2. Install above 40°F in accordance with manufacturer's installation requirements including surface prep.
 3. Do not install in raining weather or if rain is forecast for 16 hours.
 4. In hot weather, apply a thin "prime coat" prior to final coat.
 5. Install at a rate of 13.5 SF per gallon.
 6. Seal all penetrations including masonry wall ties.

2.13 MASONRY CLEANERS

- A. Proprietary Acidic Cleaner: Manufacturer's standard-strength cleaner designed for removing mortar/grout stains, efflorescence, and other new construction stains from new masonry without discoloring or damaging masonry surfaces. Use product expressly approved for intended use by cleaner manufacturer and manufacturer of masonry units being cleaned.
1. Manufacturers: Subject to compliance with requirements, available manufacturers offering products that may be incorporated into the Work include, but are not limited to, the following:
 - a. Diedrich Technologies, Inc.
 - b. EaCo Chem, Inc.
 - c. ProSoCo, Inc.

2.14 MORTAR AND GROUT MIXES

- A. General: Do not use admixtures, including pigments, air-entraining agents, accelerators, retarders, water-repellent agents, antifreeze compounds, or other admixtures, unless otherwise indicated.
1. Do not use calcium chloride in mortar or grout.
 2. Use portland cement-lime mortar unless otherwise indicated.
 3. For exterior masonry, use portland cement-lime mortar.
 4. For reinforced masonry, use portland cement-lime mortar.
 5. Add cold-weather admixture (if used) at same rate for all mortar that will be exposed to view, regardless of weather conditions, to ensure that mortar color is consistent.
- B. Preblended, Dry Mortar Mix: Furnish dry mortar ingredients in form of a preblended mix. Measure quantities by weight to ensure accurate proportions, and thoroughly blend ingredients before delivering to Project site.
- C. Mortar for Unit Masonry: Comply with ASTM C 270, Property Specification. Provide the following types of mortar for applications stated unless another type is indicated or needed to provide required compressive strength of masonry.
1. For masonry below grade or in contact with earth, use **Type S**.
 2. For reinforced masonry, use **Type N**.
 3. For exterior, above-grade, load-bearing and non-load-bearing walls and parapet walls; for interior load-bearing walls; for interior non-load-bearing partitions; and for other applications where another type is not indicated, use **Type N**.
- D. Pigmented Mortar: Use colored cement product or select and proportion pigments with other ingredients to produce color required. Do not add pigments to colored cement products.
1. Pigments shall not exceed 10 percent of portland cement by weight.
 2. Application: Use pigmented mortar for exposed mortar joints with the following units:
 - a. Decorative CMUs.

- E. Colored-Aggregate Mortar: Produce required mortar color by using colored aggregates and natural color or white cement as necessary to produce required mortar color.
 - 1. Mix to match Owner's sample.
 - 2. Application: Use colored aggregate mortar for exposed mortar joints with the following units:
 - a. Decorative CMUs.
- F. Grout for Unit Masonry: Comply with ASTM C 476.
 - 1. Use grout of type indicated or, if not otherwise indicated, of type (fine or coarse) that will comply with Table 1.15.1 in ACI 530.1/ASCE 6/TMS 602 for dimensions of grout spaces and pour height, Table 3.1.2 and of consistency at time of placement which will completely fill spaces.
 - 2. Proportion grout in accordance with ASTM C 476, 3000 psi minimum at 28 days when evaluated meeting requirements of ASTM C 1019.
 - 3. Provide grout with a slump of 9 to 11 inches as measured according to ASTM C 143 at point of placement. Slump to be provided by water content. Water reducing admixtures are not permitted.
- G. Pointing Mortar: Comply with manufacturer's recommendations for mixing.

PART 3 - EXECUTION

3.1 EXAMINATION

- A. Examine conditions, with Installer present, for compliance with requirements for installation tolerances and other conditions affecting performance of the Work.
 - 1. For the record, prepare written report, endorsed by Installer, listing conditions detrimental to performance of work.
 - 2. Verify that foundations are within tolerances specified.
 - 3. Verify that reinforcing dowels are properly placed.
- B. Before installation, examine rough-in and built-in construction for piping systems to verify actual locations of piping connections.
- C. Proceed with installation only after unsatisfactory conditions have been corrected.

3.2 INSTALLATION, GENERAL

- A. Thickness: Build cavity and composite walls and other masonry construction to full thickness shown. Build single-wythe walls to actual widths of masonry units, using units of widths indicated.
- B. Build chases and recesses to accommodate items specified in this and other Sections.

- C. Leave openings for equipment to be installed before completing masonry. After installing equipment, complete masonry to match the construction immediately adjacent to opening.
- D. Use full-size units without cutting if possible. If cutting is required to provide a continuous pattern or to fit adjoining construction, cut units with motor-driven saws; provide clean, sharp, unchipped edges. Allow units to dry before laying unless wetting of units is specified. Install cut units with cut surfaces and, where possible, cut edges concealed.
- E. Select and arrange units for exposed unit masonry to produce a uniform blend of colors and textures.
 - 1. Mix units from several pallets or cubes as they are placed.
- F. Matching Existing Masonry: Match coursing, bonding, color, and texture of existing masonry.

3.3 TOLERANCES

A. Dimensions and Locations of Elements:

- 1. For dimensions in cross section or elevation do not vary by more than plus 1/2 inch or minus 1/4 inch.
- 2. For location of elements in plan do not vary from that indicated by more than plus or minus 1/2 inch.
- 3. For location of elements in elevation do not vary from that indicated by more than plus or minus 1/4 inch in a story height or 1/2 inch total.

B. Lines and Levels:

- 1. For bed joints and top surfaces of bearing walls do not vary from level by more than 1/4 inch in 10 feet, or 1/2 inch maximum.
- 2. For conspicuous horizontal lines, such as lintels, sills, parapets, and reveals, do not vary from level by more than 1/8 inch in 10 feet, 1/4 inch in 20 feet, or 1/2 inch maximum.
- 3. For vertical lines and surfaces do not vary from plumb by more than 1/4 inch in 10 feet, 3/8 inch in 20 feet, or 1/2 inch maximum.
- 4. For conspicuous vertical lines, such as external corners, door jambs, reveals, and expansion and control joints, do not vary from plumb by more than 1/8 inch in 10 feet, 1/4 inch in 20 feet, or 1/2 inch maximum.
- 5. For lines and surfaces do not vary from straight by more than 1/4 inch in 10 feet, 3/8 inch in 20 feet, or 1/2 inch maximum.
- 6. For vertical alignment of exposed head joints, do not vary from plumb by more than 1/4 inch in 10 feet, or 1/2 inch maximum.
- 7. For faces of adjacent exposed masonry units, do not vary from flush alignment by more than 1/16 inch except due to warpage of masonry units within tolerances specified for warpage of units.

C. Joints:

- 1. For bed joints, do not vary from thickness indicated by more than plus or minus 1/8 inch, with a maximum thickness limited to 1/2 inch.

2. For exposed bed joints, do not vary from bed-joint thickness of adjacent courses by more than 1/8 inch.
3. For head and collar joints, do not vary from thickness indicated by more than plus 3/8 inch or minus 1/4 inch.
4. For exposed head joints, do not vary from thickness indicated by more than plus or minus 1/8 inch. Do not vary from adjacent bed-joint and head-joint thicknesses by more than 1/8 inch.

3.4 LAYING MASONRY WALLS

- A. Lay out walls in advance for accurate spacing of surface bond patterns with uniform joint thicknesses and for accurate location of openings, movement-type joints, returns, and offsets. Avoid using less-than-half-size units, particularly at corners, jambs, and, where possible, at other locations.
- B. Bond Pattern for Exposed Masonry: Unless otherwise indicated, lay exposed masonry in running bond; do not use units with less than nominal 4-inch horizontal face dimensions at corners or jambs.
- C. Lay concealed masonry with all units in a wythe in running bond or bonded by lapping not less than 4-inches. Bond and interlock each course of each wythe at corners. Do not use units with less than nominal 4-inch horizontal face dimensions at corners or jambs.
- D. Stopping and Resuming Work: Stop work by racking back units in each course from those in course below; do not tooth. When resuming work, clean masonry surfaces that are to receive mortar, remove loose masonry units and mortar, and wet brick if required before laying fresh masonry.
- E. Built-in Work: As construction progresses, build in items specified in this and other Sections. Fill in solidly with masonry around built-in items.
- F. Fill space between steel frames and masonry solidly with mortar unless otherwise indicated.
- G. Where built-in items are to be embedded in cores of hollow masonry units, place a layer of metal lath, wire mesh, or plastic mesh in the joint below and rod mortar or grout into core.
- H. Fill cores in hollow CMUs with grout 24 inches under bearing plates, beams, lintels, posts, and similar items unless otherwise indicated.
- I. Build non-load-bearing interior partitions full height of story to underside of solid floor or roof structure above unless otherwise indicated.
 1. Install compressible filler in joint between top of partition and underside of structure above.
 2. Fasten partition top anchors to structure above and build into top of partition. Grout cells of CMUs solidly around plastic tubes of anchors and push tubes down into grout to provide 1/2-inch clearance between end of anchor rod and end of tube. Space anchors 48 inches o.c. unless otherwise indicated.

3. Wedge non-load-bearing partitions against structure above with small pieces of metal. Fill joint with mortar after dead-load deflection of structure above approaches final position.

3.5 MORTAR BEDDING AND JOINTING

- A. Lay hollow CMUs as follows:
 1. With face shells fully bedded in mortar and with head joints of depth equal to bed joints.
 2. With webs fully bedded in mortar in all courses of piers, columns, and pilasters.
 3. With webs fully bedded in mortar in grouted masonry, including starting course on footings.
 4. With entire units, including areas under cells, fully bedded in mortar at starting course on footings where cells are not grouted.
- B. Lay solid masonry units with completely filled bed and head joints; butter ends with sufficient mortar to fill head joints and shove into place. Do not deeply furrow bed joints or slush head joints.
- C. Tool exposed joints slightly concave when thumbprint hard, using a jointer larger than joint thickness unless otherwise indicated.

3.6 COMPOSITE MASONRY

- A. Bond wythes of composite masonry together using one of the following methods:
 1. Individual Metal Ties: Provide ties as shown installed in horizontal joints, but not less than one metal tie for 1.77 sq. ft. of wall area spaced not to exceed 16 inches o.c. horizontally and 16 inches o.c. vertically. Stagger ties in alternate courses. Provide additional ties within 12 inches of openings. At intersecting and abutting walls, provide ties at no more than 16 inches o.c. vertically.
 - a. Where bed joints of wythes do not align, use adjustable (two-piece) type ties.
 2. Masonry Joint Reinforcement: Installed in horizontal mortar joints.
 - a. Where bed joints of both wythes align, use ladder-type reinforcement extending across both wythes.
 - b. Where bed joints of wythes do not align, use adjustable (two-piece) type reinforcement with continuous horizontal wire in facing wythe attached to ties.
- B. Collar Joints: Solidly fill collar joints by parging face of first wythe that is laid and shoving units of other wythe into place.
- C. Corners: Provide interlocking masonry unit bond in each wythe and course at corners unless otherwise indicated.
 1. Provide continuity with masonry joint reinforcement at corners by using prefabricated L-shaped units as well as masonry bonding.

D. Intersecting and Abutting Walls: Unless vertical expansion or control joints are shown at juncture, bond walls together as follows:

1. Provide continuity with masonry joint reinforcement by using prefabricated T-shaped units.

3.7 CAVITY WALLS

A. Bond wythes of cavity walls together using one of the following methods:

1. Individual Metal Ties: Provide ties as shown installed in horizontal joints, but not less than one metal tie for 1.77 sq. ft. of wall area spaced not to exceed 16 inches o.c. horizontally and 16 inches o.c. vertically. Stagger ties in alternate courses. Provide additional ties within 12 inches of openings. At intersecting and abutting walls, provide ties at no more than 16 inches o.c. vertically.

a. Where bed joints of wythes do not align, use adjustable (two-piece) type ties.

B. Keep cavities clean of mortar droppings and other materials during construction. Bevel beds away from cavity, to minimize mortar protrusions into cavity. Do not attempt to trowel or remove mortar fins protruding into cavity.

C. Apply air, water, and vapor barrier to face of backup wythe.

D. Installing Cavity-Wall Insulation: Place small dabs of adhesive, spaced approximately 12 inches o.c. both ways, on inside face of insulation boards. Fit courses of insulation between wall ties and other confining obstructions in cavity, with ship lap edges butted tightly both ways. Press units firmly against inside wythe of masonry or other construction as shown.

1. Apply moisture cure medium modulus sealant at all wall penetration through air, water, and vapor barrier membrane.

3.8 MASONRY JOINT REINFORCEMENT

A. General: Install entire length of longitudinal side rods in mortar with a minimum cover of 5/8 inch on exterior side of walls, 1/2 inch elsewhere. Lap reinforcement a minimum of 6 inches.

1. Space reinforcement not more than 16 inches o.c.
2. Space reinforcement not more than 8 inches o.c. in foundation walls and parapet walls.
3. Provide reinforcement not more than 8 inches above and below wall openings and extending 12 inches beyond openings in addition to continuous reinforcement.

B. Interrupt joint reinforcement at control and expansion joints unless otherwise indicated.

C. Provide continuity at wall intersections by using prefabricated T-shaped units.

D. Provide continuity at corners by using prefabricated L-shaped units.

E. Cut and bend reinforcing units as directed by manufacturer for continuity at returns, offsets, column fireproofing, pipe enclosures, and other special conditions.

3.9 ANCHORING MASONRY TO STRUCTURAL STEEL AND CONCRETE

- A. Anchor masonry to structural steel and concrete where masonry abuts or faces structural steel or concrete to comply with the following:
 - 1. Provide an open space not less than 1/2 inch wide between masonry and structural steel or concrete unless otherwise indicated. Keep open space free of mortar and other rigid materials.
 - 2. Anchor masonry with anchors embedded in masonry joints and attached to structure.
 - 3. Space anchors as indicated, but not more than 24 inches o.c. vertically and 36 inches o.c. horizontally.

3.10 ANCHORING MASONRY VENEERS

- A. Anchor masonry veneers to masonry backup with masonry-veneer anchors to comply with the following requirements:
 - 1. Locate anchor sections to allow maximum vertical differential movement of ties up and down.
 - 2. Space anchors as indicated, but not more than 16 inches o.c. vertically and 16 inches o.c. horizontally with not less than 1 anchor for each 1.77 sq. ft. of wall area. Install additional anchors within 12 inches of openings and at intervals, not exceeding 16 inches, around perimeter.

3.11 CONTROL AND EXPANSION JOINTS

- A. General: Install control and expansion joint materials in unit masonry as masonry progresses. Do not allow materials to span control and expansion joints without provision to allow for in-plane wall or partition movement.
- B. Form control joints in concrete masonry as follows:
 - 1. Fit bond-breaker strips into hollow contour in ends of CMUs on one side of control joint. Fill resultant core with grout and rake out joints in exposed faces for application of sealant.
 - 2. Install preformed control-joint gaskets designed to fit standard sash block.
 - 3. Install interlocking units designed for control joints. Install bond-breaker strips at joint. Keep head joints free and clear of mortar or rake out joint for application of sealant.
 - 4. Install temporary foam-plastic filler in head joints and remove filler when unit masonry is complete for application of sealant.
- C. Provide horizontal, pressure-relieving joints by either leaving an air space or inserting a compressible filler of width required for installing sealant and backer rod specified in Section 241080 "Joint Sealants," but not less than 3/8 inch.
 - 1. Locate horizontal, pressure-relieving joints beneath shelf angles supporting masonry.

3.12 LINTELS

- A. Install steel lintels where indicated, or as requested for all openings in masonry.
- B. Provide concrete or masonry lintels where openings of more than 12 inches for block-size units are shown without structural steel or other supporting lintels.
- C. Provide minimum bearing of 8 inches at each jamb unless otherwise indicated.

3.13 FLASHING, WEEP HOLES, CAVITY DRAINAGE, AND VENTS

- A. General: Install embedded flashing and weep holes in masonry at shelf angles, lintels, ledges, other obstructions to downward flow of water in wall, and where indicated. Install vents at shelf angles, ledges, and other obstructions to upward flow of air in cavities, and where indicated.
- B. Install flashing as follows unless otherwise indicated:
 - 1. Prepare masonry surfaces so they are smooth and free from projections that could puncture flashing. Where flashing is within mortar joint, place through-wall flashing on sloping bed of mortar and cover with mortar. Before covering with mortar, seal penetrations in flashing with adhesive, sealant, or tape as recommended by flashing manufacturer.
 - 2. At multiwythe masonry walls, extend flashing through outer wythe, turned up a minimum of 8 inches, and through inner wythe to within 1/2 inch of the interior face of wall in exposed masonry. Where interior face of wall is to receive furring or framing, carry flashing completely through inner wythe and turn flashing up approximately 2 inches on interior face.
 - 3. At multiwythe masonry walls, including cavity walls, extend flashing through outer wythe, turned up a minimum of 8 inches, and 1-1/2 inches into the inner wythe.
 - 4. At masonry-veneer walls, extend flashing through veneer, across air space behind veneer, and up face of backup masonry at least 8 inches; with upper edge extended into backup masonry joint a minimum of 2 inches.
 - 5. At lintels and shelf angles, extend flashing a minimum of 6 inches into masonry at each end. At heads and sills, extend flashing 6 inches at ends and turn up not less than 2 inches to form end dams.
 - 6. Install metal drip edges beneath flexible flashing at exterior face of wall. Stop flexible flashing 1/2 inch back from outside face of wall and adhere flexible flashing to top of metal drip edge.
- C. Install weep and vent fabrications in head joints in exterior wythes of first course of masonry immediately above embedded flashing and at top of walls and as follows:
 - 1. Use specified weep/vent products to form weep holes.
 - 2. Space weep and vent fabrications at 32 inches o.c. (minimum of three (3) at door, window, and louver heads) unless otherwise indicated.
- D. Place pea gravel in cavities as soon as practical to underside of thru-wall flashing to maintain drainage.

- E. Place cavity drainage material in cavities to comply with configuration requirements for cavity drainage material in "Miscellaneous Masonry Accessories" Article.
- F. Install vents in head joints in exterior wythes as high side of masonry veneer. Use specified weep/vent products to form vents.

3.14 REINFORCED UNIT MASONRY INSTALLATION

- A. Temporary Formwork and Shores: Construct formwork and shores as needed to support reinforced masonry elements during construction.
 - 1. Construct formwork to provide shape, line, and dimensions of completed masonry as indicated. Make forms sufficiently tight to prevent leakage of mortar and grout. Brace, tie, and support forms to maintain position and shape during construction and curing of reinforced masonry.
 - 2. Do not remove forms and shores until reinforced masonry members have hardened sufficiently to carry their own weight and other loads that may be placed on them during construction.
- B. Placing Reinforcement: Comply with requirements in ACI 530.1/ASCE 6/TMS 602.
- C. Grouting: Do not place grout until entire height of masonry to be grouted has attained enough strength to resist grout pressure.
 - 1. Comply with requirements in ACI 530.1/ASCE 6/TMS 602 for cleanouts and for grout placement, including minimum grout space and maximum pour height.
 - 2. Limit height of vertical grout pours to not more than 60 inches.

3.15 FIELD QUALITY CONTROL

- A. Testing and Inspecting: **Owner will engage** special inspectors to perform tests and inspections and prepare reports. Allow inspectors access to scaffolding and work areas, as needed to perform tests and inspections. Retesting of materials that fail to comply with specified requirements shall be done at Contractor's expense.
- B. Inspections: Level 1 special inspections according to the "International Building Code."
 - 1. Begin masonry construction only after inspectors have verified proportions of site-prepared mortar.
 - 2. Place grout only after inspectors have verified compliance of grout spaces and of grades, sizes, and locations of reinforcement.
 - 3. Place grout only after inspectors have verified proportions of site-prepared grout.
- C. Testing Prior to Construction: One set of tests.
- D. Testing Frequency: One set of tests for each 5000 sq. ft. of wall area or portion thereof.
- E. Concrete Masonry Unit Test: For each type of unit provided, according to ASTM C 140 for compressive strength.

- F. Mortar Aggregate Ratio Test (Proportion Specification): For each mix provided, according to ASTM C 780.
- G. Mortar Test (Property Specification): For each mix provided, according to ASTM C 780. Test mortar for mortar air content and compressive strength.
- H. Grout Test (Compressive Strength): For each mix provided, according to ASTM C 1019.
- I. Prism Test: For each type of construction provided, according to ASTM C 1314 at 7 days and at 28 days.

3.16 REPAIRING, POINTING, AND CLEANING

- A. Remove and replace masonry units that are loose, chipped, broken, stained, or otherwise damaged or that do not match adjoining units. Install new units to match adjoining units; install in fresh mortar, pointed to eliminate evidence of replacement.
- B. Pointing: During the tooling of joints, enlarge voids and holes, except weep holes, and completely fill with mortar. Point up joints, including corners, openings, and adjacent construction, to provide a neat, uniform appearance. Prepare joints for sealant application, where indicated.
- C. In-Progress Cleaning: Clean unit masonry as work progresses by dry brushing to remove mortar fins and smears before tooling joints.
- D. Final Cleaning: After mortar is thoroughly set and cured, clean exposed masonry as follows:
 1. Remove large mortar particles by hand with wooden paddles and nonmetallic scrape hoes or chisels.
 2. Test cleaning methods on sample wall panel; leave one-half of panel uncleaned for comparison purposes. Obtain Owner's approval of sample cleaning before proceeding with cleaning of masonry.
 3. Protect adjacent stone and nonmasonry surfaces from contact with cleaner by covering them with liquid strippable masking agent or polyethylene film and waterproof masking tape.
 4. Wet wall surfaces with water before applying cleaners; remove cleaners promptly by rinsing surfaces thoroughly with clear water.
 5. Clean masonry with a proprietary acidic cleaner applied according to manufacturer's written instructions.
 6. Clean concrete masonry by cleaning method indicated in NCMA TEK 8-2A applicable to type of stain on exposed surfaces.

3.17 MASONRY WASTE DISPOSAL

- A. Salvageable Materials: Unless otherwise indicated, excess masonry materials are Contractor's property. At completion of unit masonry work, remove from Project site.

- B. Waste Disposal as Fill Material: Dispose of clean masonry waste, including excess or soil-contaminated sand, waste mortar, and broken masonry units, by crushing and mixing with fill material as fill is placed.
1. Crush masonry waste to less than 4 inches in each dimension.
 2. Mix masonry waste with at least two parts of specified fill material for each part of masonry waste. Fill material is specified in Section 280020 "Earth Moving."
 3. Do not dispose of masonry waste as fill within 18 inches of finished grade.
- C. Excess Masonry Waste: Remove excess clean masonry waste that cannot be used as fill, as described above, and other masonry waste, and legally dispose of off Owner's property.

** END OF SECTION **

**SECTION 240040
CAST STONE MASONRY**

PART 1 - GENERAL

1.1 SUMMARY

A. Section Includes:

1. Cast stone trim, including the following:
 - a. Wall caps.
 - b. Belt courses.
 - c. Water tables.

1.2 ACTION SUBMITTALS

A. Product Data: For each type of product indicated.

1. For cast stone units, include construction details, material descriptions, dimensions of individual components and profiles, and finishes.

B. Shop Drawings: Show fabrication and installation details for cast stone units. Include dimensions, details of reinforcement and anchorages if any, and indication of finished faces.

1. Include building elevations showing layout of units and locations of joints and anchors.

C. Full-Size Samples: For each color, texture and shape of cast stone unit required.

1. Make available for Owner's review at Project site.
2. Make Samples from materials to be used for units used on Project immediately before beginning production of units for Project.
3. Approved Samples may be installed in the Work.

1.3 INFORMATIONAL SUBMITTALS

A. Qualification Data: For manufacturer and testing agency.

1. Include copies of material test reports for completed projects, indicating compliance of cast stone with ASTM C 1364.

B. Material Test Reports: For each mix required to produce cast stone, based on testing according to ASTM C 1364, including test for resistance to freezing and thawing.

1. Provide test reports based on testing within previous two years.

1.4 QUALITY ASSURANCE

- A. **Manufacturer Qualifications:** A qualified manufacturer of cast stone units similar to those indicated for this Project, that has sufficient production capacity to manufacture required units, and is a plant certified by the Cast Stone Institute, the Architectural Precast Association or the Precast/Prestressed Concrete Institute for Group A, Category AT.
- B. **Testing Agency Qualifications:** Qualified according to ASTM E 329 for testing indicated.
- C. **Source Limitations for Cast Stone:** Obtain cast stone units through single source from single manufacturer.
- D. **Source Limitations for Mortar Materials:** Obtain mortar ingredients of a uniform quality, including color, from one manufacturer for each cementitious component and from one source or producer for each aggregate.
- E. **Mockups:** Furnish cast stone for installation in mockups specified in Section 240030 "Unit Masonry."
- F. **Mockups:** Build mockups to verify selections made under sample submittals and to demonstrate aesthetic effects and set quality standards for materials and execution.
 - 1. Build mockup of typical wall area.

1.5 DELIVERY, STORAGE, AND HANDLING

- A. Coordinate delivery of cast stone with unit masonry work to avoid delaying the Work and to minimize the need for on-site storage.
- B. Pack, handle, and ship cast stone units in suitable packs or pallets.
 - 1. Lift with wide-belt slings; do not use wire rope or ropes that might cause staining. Move cast stone units, if required, using dollies with wood supports.
 - 2. Store cast stone units on wood skids or pallets with nonstaining, waterproof covers, securely tied. Arrange to distribute weight evenly and to prevent damage to units. Ventilate under covers to prevent condensation.
- C. Store cementitious materials on elevated platforms, under cover, and in a dry location. Do not use cementitious materials that have become damp.
- D. Store mortar aggregates where grading and other required characteristics can be maintained and contamination can be avoided.

1.6 PROJECT CONDITIONS

- A. **Cold-Weather Requirements:** Do not use frozen materials or materials mixed or coated with ice or frost. Do not build on frozen substrates. Comply with cold-weather construction requirements in ACI 530.1/ASCE 6/TMS 602.

1. Cold-Weather Cleaning: Use liquid cleaning methods only when air temperature is 40 deg F and above and will remain so until cast stone has dried, but no fewer than seven days after completing cleaning.
- B. Hot-Weather Requirements: Comply with hot-weather construction requirements in ACI 530.1/ASCE 6/TMS 602.

PART 2 - PRODUCTS

2.1 CAST STONE MATERIALS

- A. General: Comply with ASTM C 1364 and the following:
- B. Portland Cement: ASTM C 150, Type I or Type III, containing not more than 0.60 percent total alkali when tested according to ASTM C 114. Provide natural color or white cement as required to produce cast stone color indicated.
- C. Coarse Aggregates: Granite, quartz, or limestone complying with ASTM C 33; gradation and colors as needed to produce required cast stone textures and colors.
- D. Fine Aggregates: Natural sand or crushed stone complying with ASTM C 33, gradation and colors as needed to produce required cast stone textures and colors.
- E. Color Pigment: ASTM C 979, synthetic mineral-oxide pigments or colored water-reducing admixtures; color stable, free of carbon black, nonfading, and resistant to lime and other alkalis.
- F. Admixtures: Use only admixtures specified or approved in writing by Owner.
 1. Do not use admixtures that contain more than 0.1 percent water-soluble chloride ions by mass of cementitious materials. Do not use admixtures containing calcium chloride.
 2. Use only admixtures that are certified by manufacturer to be compatible with cement and other admixtures used.
 3. Air-Entraining Admixture: ASTM C 260. Add to mixes for units exposed to the exterior at manufacturer's prescribed rate to result in an air content of 4 to 6 percent, except do not add to zero-slump concrete mixes.
 4. Water-Reducing Admixture: ASTM C 494, Type A.
 5. Water-Reducing, Retarding Admixture: ASTM C 494 Type D.
 6. Water-Reducing, Accelerating Admixture: ASTM C 494, Type E.
- G. Reinforcement: Deformed steel bars complying with ASTM A 615, Grade 60. Use galvanized or epoxy-coated reinforcement when covered with less than 1-1/2 inches of cast stone material.
 1. Galvanized Coating: ASTM A 767.
- H. Embedded Anchors and Other Inserts: Fabricated from stainless steel complying with ASTM A 240, ASTM A 276, or ASTM A 666, Type 304.

2.2 CAST STONE UNITS

- A. Manufacturers: Subject to compliance with requirements, available manufacturers offering products that may be incorporated into the Work include, but are not limited to, the following:
1. Stone Legends.
 2. Coral Cast Architectural Stone.
 3. Sun Precast Co., Inc.
- B. Provide cast stone units complying with ASTM C 1364 using either the vibrant dry tamp or wet-cast method.
1. Provide units that are resistant to freezing and thawing as determined by laboratory testing according to ASTM C 666, Procedure A, as modified by ASTM C 1364.
- C. Fabricate units with sharp arris and accurately reproduced details, with indicated texture on all exposed surfaces unless otherwise indicated.
1. Slope exposed horizontal surfaces 1:12 to drain unless otherwise indicated.
 2. Provide raised fillets at backs of sills and at ends indicated to be built into jambs.
 3. Provide drips on projecting elements unless otherwise indicated.
- D. Fabrication Tolerances:
1. Variation in Cross Section: Do not vary from indicated dimensions by more than 1/8 inch.
 2. Variation in Length: Do not vary from indicated dimensions by more than 1/360 of the length of unit or 1/8 inch, whichever is greater, but in no case by more than 1/4 inch.
 3. Warp, Bow, and Twist: Not to exceed 1/360 of the length of unit or 1/8 inch, whichever is greater.
 4. Location of Grooves, False Joints, Holes, Anchorages, and Similar Features: Do not vary from indicated position by more than 1/8 inch on formed surfaces of units and 3/8 inch on unformed surfaces.
- E. Cure units as follows:
1. Cure units in enclosed moist curing room at 95 to 100 percent relative humidity and temperature of 100 deg F for 12 hours or 70 deg F for 16 hours.
 2. Keep units damp and continue curing to comply with one of the following:
 - a. No fewer than five days at mean daily temperature of 70 deg F or above.
 - b. No fewer than six days at mean daily temperature of 60 deg F or above.
 - c. No fewer than seven days at mean daily temperature of 50 deg F or above.
 - d. No fewer than eight days at mean daily temperature of 45 deg F or above.
- F. Acid etch units after curing to remove cement film from surfaces to be exposed to view.
- G. Colors and Textures: As **selected by Owner** from manufacturer's full range.
- H. Color and Texture: Provide units with fine-grained texture and buff color resembling Indiana limestone.

2.3 MORTAR MATERIALS

- A. Portland Cement: ASTM C 150, Type I, except Type III may be used for cold-weather construction. Provide natural color or white cement as required to produce mortar color indicated.
- B. Hydrated Lime: ASTM C 207, Type S.
- C. Portland Cement-Lime Mix: Packaged blend of portland cement and hydrated lime containing no other ingredients.
- D. Mortar Pigments: Natural and synthetic iron oxides and chromium oxides, compounded for use in mortar mixes and complying with ASTM C 979. Use only pigments with a record of satisfactory performance in masonry mortar.
 - 1. Products: Subject to compliance with requirements, available products that may be incorporated into the Work include, but are not limited to, the following:
 - a. Davis Colors; True Tone Mortar Colors.
 - b. Lanxess Corporation; Bayferrox Iron Oxide Pigments.
 - c. Solomon Colors, Inc.; SGS Mortar Colors.
- E. Colored Cement Product: Packaged blend made from portland cement and hydrated lime and mortar pigments, all complying with specified requirements and containing no other ingredients.
 - 1. Colored Portland Cement-Lime Mix:
 - a. Products: Subject to compliance with requirements, available products that may be incorporated into the Work include, but are not limited to, the following:
 - 1) Capital Materials Corporation; Riverton Portland Cement Lime Custom Color.
 - 2) Holcim (US) Inc.; Rainbow Mortamix Custom Color Cement/Lime.
 - 3) Lafarge North America Inc.; Eaglebond Portland & Lime.
 - 4) Lehigh Cement Company; Lehigh Custom Color Portland/Lime Cement.
 - 2. Formulate blend as required to produce color indicated or, if not indicated, as selected from manufacturer's standard colors.
 - 3. Pigments shall not exceed 10 percent of portland cement by weight.
- F. Aggregate for Mortar: ASTM C 144.
 - 1. For mortar that is exposed to view, use washed aggregate consisting of natural sand or crushed stone.
 - 2. For joints less than 1/4 inch thick, use aggregate graded with 100 percent passing the No. 16 sieve.
 - 3. White-Mortar Aggregates: Natural white sand or crushed white stone.
 - 4. Colored-Mortar Aggregates: Natural sand or crushed stone of color necessary to produce required mortar color.

- G. Water: Potable.

2.4 ACCESSORIES

- A. Anchors: Type and size required or indicated, fabricated from Type 304 stainless steel complying with ASTM A 240, ASTM A 276, or ASTM A 666.
- B. Dowels: 1/2-inch-diameter, round bars, fabricated from Type 304 stainless steel complying with ASTM A 240, ASTM A 276, or ASTM A 666.
- C. Proprietary Acidic Cleaner: Manufacturer's standard-strength cleaner designed for removing mortar/grout stains, efflorescence, and other new construction stains from new masonry without discoloring or damaging masonry surfaces. Use product expressly approved for intended use by cast stone manufacturer and expressly approved by cleaner manufacturer for use on cast stone and adjacent masonry materials.
 - 1. Manufacturers: Subject to compliance with requirements, available manufacturers offering products that may be incorporated into the Work include, but are not limited to, the following:
 - a. Diedrich Technologies, Inc.
 - b. EaCo Chem, Inc.
 - c. ProSoCo, Inc.

2.5 MORTAR MIXES

- A. Do not use admixtures including pigments, air-entraining agents, accelerators, retarders, water-repellent agents, antifreeze compounds, or other admixtures unless otherwise indicated.
 - 1. Do not use calcium chloride in mortar or grout.
 - 2. Use portland cement-lime mortar unless otherwise indicated.
- B. Comply with ASTM C 270, Proportion Specification.
 - 1. For setting mortar, use **Type N**.
 - 2. For pointing mortar, use **Type N**.
- C. Pigmented Mortar: Use colored cement product.
 - 1. Pigments shall not exceed 10 percent of portland cement by weight.
 - 2. Mix to match Owner's sample.
 - 3. Application: Use pigmented mortar for exposed mortar joints.
- D. Colored-Aggregate Mortar: Produce required mortar color by using colored aggregates and natural color or white cement as necessary to produce required mortar color.
 - 1. Mix to match Owner's sample.
 - 2. Application: Use colored aggregate mortar for exposed mortar joints.

2.6 SOURCE QUALITY CONTROL

- A. Engage a qualified independent testing agency to sample and test cast stone units according to ASTM C 1364.
 - 1. Include one test for resistance to freezing and thawing.

PART 3 - EXECUTION

3.1 EXAMINATION

- A. Examine substrates and conditions, with Installer present, for compliance with requirements for installation tolerances and other conditions affecting performance of work.
- B. Proceed with installation only after unsatisfactory conditions have been corrected.

3.2 SETTING CAST STONE IN MORTAR

- A. Set cast stone as indicated on Drawings. Set units accurately in locations indicated with edges and faces aligned according to established relationships and indicated tolerances.
 - 1. Install anchors, supports, fasteners, and other attachments indicated or necessary to secure units in place.
 - 2. Coordinate installation of cast stone with installation of flashing specified in other Sections.
- B. Wet joint surfaces thoroughly before applying mortar or setting in mortar.
- C. Set units in full bed of mortar with full head joints unless otherwise indicated.
 - 1. Set units with joints 3/8 to 1/2 inch wide unless otherwise indicated.
 - 2. Build anchors and ties into mortar joints as units are set.
 - 3. Fill dowel holes and anchor slots with mortar.
 - 4. Fill collar joints solid as units are set.
 - 5. Build concealed flashing into mortar joints as units are set.
 - 6. Keep head joints in coping and other units with exposed horizontal surfaces open to receive sealant.
 - 7. Keep joints at shelf angles open to receive sealant.
- D. Rake out joints for pointing with mortar to depths of not less than 3/4 inch. Rake joints to uniform depths with square bottoms and clean sides. Scrub faces of units to remove excess mortar as joints are raked.
- E. Point mortar joints by placing and compacting mortar in layers not greater than 3/8 inch. Compact each layer thoroughly and allow it to become thumbprint hard before applying next layer.
- F. Tool exposed joints slightly concave when thumbprint hard, using a jointer larger than joint thickness unless otherwise indicated.

- G. Provide sealant joints at copings and other horizontal surfaces, at expansion, control, and pressure-relieving joints, and at locations indicated.
1. Keep joints free of mortar and other rigid materials.
 2. Form joint of width indicated, but not less than 3/8 inch.
 3. Prime cast stone surfaces to receive sealant and install compressible backer rod in joints before applying sealant unless otherwise indicated.
 4. Prepare and apply sealant of type and at locations indicated to comply with applicable requirements in Section 241080 "Joint Sealants."

3.3 INSTALLATION TOLERANCES

- A. Variation from Plumb: Do not exceed 1/8 inch in 10 feet, 1/4 inch in 20 feet, or 1/2 inch maximum.
- B. Variation from Level: Do not exceed 1/8 inch in 10 feet, 1/4 inch in 20 feet, or 1/2 inch maximum.
- C. Variation in Joint Width: Do not vary joint thickness more than 1/8 inch in 36 inches or one-fourth of nominal joint width, whichever is less.
- D. Variation in Plane between Adjacent Surfaces (Lipping): Do not vary from flush alignment with adjacent units or adjacent surfaces indicated to be flush with units by more than 1/16 inch, except where variation is due to warpage of units within tolerances specified.

3.4 ADJUSTING AND CLEANING

- A. Remove and replace stained and otherwise damaged units and units not matching approved Samples. Cast stone may be repaired if methods and results are approved by Owner.
- B. Replace units in a manner that results in cast stone matching approved Samples, complying with other requirements, and showing no evidence of replacement.
- C. In-Progress Cleaning: Clean cast stone as work progresses.
1. Remove mortar fins and smears before tooling joints.
 2. Remove excess sealant immediately, including spills, smears, and spatter.
- D. Final Cleaning: After mortar is thoroughly set and cured, clean exposed cast stone as follows:
1. Remove large mortar particles by hand with wooden paddles and nonmetallic scrape hoes or chisels.
 2. Test cleaning methods on sample; leave one sample uncleaned for comparison purposes. Obtain Owner's approval of sample cleaning before proceeding with cleaning of cast stone.
 3. Protect adjacent surfaces from contact with cleaner by covering them with liquid strippable masking agent or polyethylene film and waterproof masking tape.
 4. Wet surfaces with water before applying cleaners; remove cleaners promptly by rinsing thoroughly with clear water.

5. Clean cast stone by bucket-and-brush hand-cleaning method described in BIA Technical Notes 20.
6. Clean cast stone with proprietary acidic cleaner applied according to manufacturer's written instructions.

****END OF SECTION****

SECTION 240050 BENTONITE WATERPROOFING

PART 1 - GENERAL

1.1 SUMMARY

A. Section Includes:

1. Bentonite waterproofing.
2. Insulation drainage panels.

B. Related Requirements:

1. Section 280010 "Earth Moving" for excavating and backfilling.
2. Section 280040 "Excavation Support and Protection" for permanent below-grade support systems that receive blind-side waterproofing.

1.2 PREINSTALLATION MEETINGS

- A. Preinstallation Conference:** Conduct conference at Project site.

1.3 ACTION SUBMITTALS

A. Product Data: For each type of product.

1. Include construction details, material descriptions, and installation instructions.

- B. Shop Drawings:** Include installation details for waterproofing, penetrations, and interface with other work.

C. Samples: For each of the following products, in sizes indicated:

1. Waterproofing: **6 inches** square.
2. Protection Course: **6 inches** square.
3. Insulation Drainage Panels: **6 inches** square.

1.4 INFORMATIONAL SUBMITTALS

- A. Product Certificates:** For each type of waterproofing material.

- B. Preconstruction Test Reports:** For water samples taken at Project site along with recommendations resulting from these tests.

- C. Field quality-control reports.**

- D. Sample Warranty:** For manufacturer's special warranty.

1.5 QUALITY ASSURANCE

- A. Mockups: Build mockups to set quality standards for fabrication and installation.
 - 1. Build mockup of installation on typical vertical surfaces **10 sq. ft.** in size.
 - 2. Subject to compliance with requirements, approved mockups may become part of the completed Work if undisturbed at time of Substantial Completion.

1.6 PRECONSTRUCTION TESTING

- A. Preconstruction Testing: Engage a qualified testing agency to perform preconstruction testing on ground water.
 - 1. Obtain water samples from Project site at approximate locations where waterproofing will be installed and test for acids, alkalis, brine, or other contaminants that may inhibit performance of waterproofing materials.
 - 2. Comply with waterproofing manufacturer's written instructions for testing.

1.7 FIELD CONDITIONS

- A. Weather Limitations: Proceed with installation only when existing and forecasted weather conditions permit bentonite waterproofing to be installed according to manufacturer's written instructions and warranty requirements.
 - 1. Do not apply waterproofing materials to surfaces where ice or frost is visible. Do not apply bentonite waterproofing materials in areas with standing water.
 - 2. Do not place bentonite clay products in panel or composite form on damp surfaces unless such practice is approved in writing by manufacturer.

1.8 WARRANTY

- A. Special Warranty: Manufacturer and Installer agree(s) to repair or replace components of bentonite waterproofing system that fail in materials or workmanship within specified warranty period.
 - 1. Warranty Period: 10 years from date of Substantial Completion.

PART 2 - PRODUCTS

2.1 GEOTEXTILE/BENTONITE SHEETS

- A. Regular Geotextile/Bentonite Sheet: Minimum of **1.0 lb/sq. ft.** of bentonite clay granules between two layers of polypropylene geotextile fabric, one woven and one nonwoven, needle punched and heat fused together.
 - 1. Products: Subject to compliance with requirements, available products that may be incorporated into the Work include, but are not limited to, the following:

- a. Carlisle Coatings & Waterproofing; CCW MiraCLAY.
 - b. CETCO, a subsidiary of AMCOL International Corp; Voltex.
2. Grab Tensile Strength: **95 lbf** according to ASTM D 4632.
 3. Puncture Resistance: **100 lbf** according to ASTM D 4833.

2.2 PROTECTION COURSE

- A. Protection Course: Protection mat of type and thickness as recommended in writing by waterproofing manufacturer for each Project condition.
 1. Adhesive: As recommended in writing by waterproofing manufacturer.

2.3 INSULATION DRAINAGE PANELS

- A. Insulation Drainage Panels, General: Comply with Section 240060 "Thermal Insulation" for general building insulation, including insulation drainage panels.
- B. Geotextile-Faced Wall Insulation Drainage Panels: Extruded-polystyrene board insulation according to ASTM C 578, Type VI, **40-psi** minimum compressive strength; fabricated with tongue-and-groove edges and with one side having grooved drainage channels faced with nonwoven-geotextile filter fabric.
 1. Products: Subject to compliance with requirements, available products that may be incorporated into the Work include, but are not limited to, the following:
 - a. T. Clear Corporation; Thermadry 1250.

2.4 ACCESSORIES

- A. Granular Bentonite: Sodium bentonite clay containing a minimum of 90 percent montmorillonite (hydrated aluminum silicate), with a minimum of 90 percent passing a **No. 20** sieve.
- B. Bentonite Mastic: Bentonite compound of trowelable consistency, specifically formulated for application at joints and penetrations.
- C. Bentonite Tubes: Manufacturer's standard **2-inch**-diameter, water-soluble tube containing approximately **1.5 lb/ft.** of granular bentonite; hermetically sealed; designed specifically for placing on wall footings at line of joint with exterior base of wall.
- D. Termination Bar: Extruded-aluminum or formed-stainless-steel bars with upper flange to receive sealant.
- E. Plastic Protection Sheet: Polyethylene sheeting according to ASTM D 4397; thickness as recommended in writing by waterproofing manufacturer to suit application but at least **6 mils** thick.

- F. Cement Grout Patching Material: Grout mix compatible with substrate being patched and recommended in writing by waterproofing manufacturer.
- G. Masonry Fasteners: Case-hardened nails or hardened-steel, powder-actuated fasteners. Depending on manufacturer's written requirements, provide **1/2- or 1-inch-** diameter washers under fastener heads.
- H. Sealants: As recommended in writing by waterproofing manufacturer.
- I. Tapes: Waterproofing manufacturer's recommended waterproof tape for joints between sheets, membranes, or panels.
- J. Adhesive: Waterproofing manufacturer's water-based adhesive used to secure waterproofing to both vertical and horizontal surfaces.

PART 3 - EXECUTION

3.1 EXAMINATION

- A. Examine substrates, areas, and conditions, with Installer present, for compliance with requirements for substrate preparations and other conditions affecting performance of bentonite waterproofing.
- B. Examine bentonite materials before installation. Reject materials that have been prematurely exposed to moisture.
- C. Verify that substrate is complete and that work that will penetrate waterproofing is complete and rigidly installed.
- D. Proceed with installation only after unsatisfactory conditions have been corrected.

3.2 PREPARATION

- A. Clean, prepare, and treat substrates according to manufacturer's written instructions.
- B. Formed Concrete Surfaces: Remove fins and projections. Fill voids, rock pockets, form-tie holes, and other defects with bentonite mastic or cement grout patching material according to manufacturer's written instructions.
- C. Excavation Support and Protection System: If water is seeping, use plastic protection sheets or other suitable means to prevent wetting the bentonite waterproofing. Fill minor gaps and spaces **1/8 inch** wide or wider with wood, metal, concrete, or other appropriate filling material. Cover or fill large voids and crevices with cement mortar according to manufacturer's written instructions.

3.3 INSTALLATION, GENERAL

- A. Prepare substrates, voids, cracks, and cavities; and install waterproofing and accessories according to manufacturer's written instructions.
 - 1. Before installing, verify the correct side of waterproofing that shall face substrate surface.
 - 2. Apply granular bentonite around penetrations in horizontal surfaces and changes in plane according to manufacturer's details in preparation for bentonite tubes and mastic.
 - 3. Apply bentonite tubes, bentonite mastic, or both at changes of plane, construction joints in substrate, projections, and penetrations.
 - 4. Prime concrete substrates. Primer may be omitted on concrete surfaces that comply with manufacturer's written requirements for dryness, surface texture, and freedom from imperfections.
- B. Apply bentonite tubes continuously on footing against base of wall to be waterproofed.
- C. Protect waterproofing from damage and wetting before and during subsequent construction operations. Repair punctures, tears, and cuts.
- D. Install protection course before backfilling or placing overburden when recommended in writing by waterproofing manufacturer.

3.4 GEOTEXTILE/BENTONITE SHEET INSTALLATION

- A. Install a continuous layer of waterproofing sheets directly against surface to be waterproofed. Lap ends and edges a minimum of **4 inches** on horizontal and vertical substrates unless otherwise indicated. Stagger end joints between sheets a minimum of **24 inches**. Fasten seams by stapling to adjacent sheet or nailing to substrate.
- B. Below Structural Slabs-on-Grade: Place waterproofing sheets on compacted substrate with ends and edges lapped and stapled.
 - 1. Install a layer of waterproofing sheets under footings; or continue waterproofing through key joints between footings and foundation walls, and extend a minimum of **8 inches** up or beyond perimeter slab forms.
- C. Concrete Walls: Starting at bottom of wall, apply waterproofing sheets horizontally against wall. Secure with masonry fasteners spaced according to manufacturer's written instructions. Extend to bottom of footing, grade beam, or wall, and secure.
 - 1. Termination at Grade: Extend waterproofing sheets to within **6 inches** of finish grade unless otherwise indicated. Secure top edge with termination bar. Apply sealant to top edge of termination bar.
- D. Excavation Support and Protection (Permanent Shoring): Encase tieback heads, rods, nuts, and plates according to waterproofing manufacturer's written instructions for each configuration.
 - 1. Install a layer of waterproofing sheets, with ends and edges lapped and nailed to shoring. Cover waterproofing with plastic protection sheets if needed for protection from precipitation; remove plastic sheets before placing concrete.

2. Inspect and repair waterproofing after reinforcing steel has been placed. Coordinate and control concrete placement to avoid damage to waterproofing.

3.5 INSULATION DRAINAGE PANEL INSTALLATION

- A. Install over waterproofed surfaces. Cut and fit to within **3/4 inch** of projections and penetrations.
- B. Ensure that drainage channels are aligned and free of obstructions.
- C. On vertical surfaces, set insulation units in adhesive or tape applied according to manufacturer's written instructions.

3.6 FIELD QUALITY CONTROL

- A. Manufacturer's Field Service: Engage a factory-authorized service representative to test and inspect completed waterproofing installation before covering with other construction, and provide written report stating that installation complies with manufacturer's written instructions.
 1. Remove and replace applications of bentonite waterproofing where inspection indicates that it does not comply with specified requirements.
- B. Flood Testing: Flood test each deck area for leaks, according to procedures in ASTM D 5957 and manufacturer's instructions, after completing waterproofing but before permanent overlaying construction is placed. Install temporary containment assemblies, plug or dam drains, and flood with potable water.
 1. Flood to an average depth of **2-1/2 inches** with a minimum depth of **1 inch**, but not exceeding a depth of **4 inches**. Maintain **2 inches** of clearance from top of membrane flashings.
 2. Flood each area for 24 hours.
 3. After flood testing, repair leaks, repeat flood test, and make further repairs until waterproofing installation is watertight.

** END OF SECTION **

SECTION 240060 THERMAL INSULATION

PART 1 - GENERAL

1.1 SUMMARY

A. This Section includes the following:

1. Perimeter insulation under slabs-on-grade.
2. Concealed building insulation.
3. Vapor retarder.

B. Related Sections include the following:

1. Section 240030 "Unit Masonry" for insulation installed in cavity walls.
2. Section 080010 "Ethylene-Propylene-Diene-Monomer (EPDM) Roofing" for insulation specified as part of roofing construction.
3. Section 120080 "Plumbing Insulation."
4. Section 160080 "HVAC Insulation."

1.2 SUBMITTALS

A. Product Data: For each type of product indicated.

B. Samples for Verification: Full-size units for each type of exposed insulation indicated.

C. Product Test Reports: Based on evaluation of comprehensive tests performed by a qualified testing agency for insulation products.

1.3 QUALITY ASSURANCE

A. Source Limitations: Obtain each type of building insulation through one source from a single Manufacturer.

B. Fire-Test-Response Characteristics: Provide insulation and related materials with the fire-test-response characteristics indicated, as determined by testing identical products per test method indicated below by UL or another testing and inspecting agency acceptable to authorities having jurisdiction. Identify materials with appropriate markings of applicable testing and inspecting agency.

1. Surface Burning Characteristics: ASTM E 84.
2. Fire Resistance Ratings: ASTM E 119.
3. Combustion Characteristics: ASTM E 136.

1.4 DELIVERY, STORAGE, AND HANDLING

- A. Protect insulation materials from physical damage and from deterioration by moisture, soiling, and other sources. Store inside and in a dry location. Comply with Manufacturer's written instructions for handling, storing, and protecting during installation.
- B. Protect plastic insulation as follows:
 - 1. Do not expose to sunlight, except to extent necessary for period of installation and concealment.
 - 2. Protect against ignition at all times. Do not deliver plastic insulating materials to Project site before installation time.
 - 3. Complete installation and concealment of plastic materials as rapidly as possible in each area of construction.

PART 2 - PRODUCTS

2.1 INSULATING MATERIALS

- A. General: Provide insulating materials which comply with requirements indicated for materials, compliance with referenced standards, and other characteristics.

2.2 MANUFACTURERS

- A. In other Part 2 articles where titles below introduce lists, the following requirements apply to product selection:
 - 1. Available Products: Subject to compliance with requirements, products that may be incorporated into the Work include, but are not limited to, products specified.
- B. Extruded Polystyrene Board Insulation with Increased R-Value for Slabs on Grade and Foundation Walls: ASTM C 578, Type IV, but with an aged thermal resistance (R-value) for 1-inch thickness of 5.5 deg F x h x sq. ft./Btu at 75 deg F at 5 years; closed-cell product with a carbon-black filler and extruded with an integral skin.
 - 1. Manufacturers:
 - a. High-R CW Plus; Owens Corning. Provide minimum **R-11**.
 - b. Refer to Section 071700 "Bentonite Waterproofing" for additional requirements for foundation wall insulation as part of drainage panels and waterproofing system.

C. Vapor Retarder Under-Slabs-On-Grade:

1. Manufacturer:

- a. **Griffolyn Type 105** Vapor Retarder.
- b. Material: 7 ply laminate combining 4 layers of high density polyethylene and 3 high strength non-woven cord grids.
- c. Weight: ASTM D 3776, 82 lb/1,000 SF.
- d. Puncture Propagation Tear: ASTM D 2582, 45 lb.
- e. Permeance (Perm): ASTM E 96, 0.021 grains/hr-SF in HG.
- f. Drop Dart: ASTM D 1709, 2,300 g.
- g. Tensile Strength: 3 inches, ASTM D 882, 275 lb/5,464 psi.
- h. Puncture Strength: ASTM D 4833, 72 lb.
- i. Usable Temperature Range: -45 to 170 degrees.
- j. Tape: Pressure-sensitive tape of type recommended by vapor retarder Manufacturer for sealing all joints and penetrations in vapor retarder.
- k. Extend vapor retarder and seal with waterproofing system at foundation walls below grade. Refer to Section 240050 "Bentonite Waterproofing".

2.3 INSULATION FASTENERS

A. Adhesively Attached, Spindle-Type Anchors: Plate welded to projecting spindle; capable of holding insulation of thickness indicated securely in position indicated with self-locking washer in place; and complying with the following requirements:

1. Products:

- a. AGM Industries, Inc.; Series T TACTOO Insul-Hangers.
 - b. Eckel Industries of Canada; Stic-Klip Type N Fasteners.
 - c. Gemco; Spindle Type.
2. Plate: Perforated galvanized carbon-steel sheet, 0.030 inch thick by 2 inches square.
 3. Spindle: Copper-coated, low carbon steel; fully annealed; 0.105 inch in diameter; length to suit depth of insulation indicated.

PART 3 - EXECUTION

3.1 EXAMINATION

A. Examine substrates and conditions, with Installer present, for compliance with requirements of Sections in which substrates and related work are specified and for other conditions affecting performance.

1. Proceed with installation only after unsatisfactory conditions have been corrected.

3.2 PREPARATION

- A. Clean substrates of substances harmful to insulation or vapor retarders, including removing projections capable of puncturing vapor retarders or of interfering with insulation attachment.

3.3 INSTALLATION, GENERAL

- A. Comply with insulation Manufacturer's written instructions applicable to products and application indicated.
- B. Install insulation that is undamaged, dry, and unsoiled and that has not been left exposed at any time to ice, rain, and snow.
- C. Extend insulation in thickness indicated to envelop entire area to be insulated. Cut and fit tightly around obstructions and fill voids with insulation. Remove projections that interfere with placement.
- D. Water Piping Coordination: If water piping is located within insulated exterior walls, coordinate location of piping to ensure that it is placed on warm side of insulation and insulation encapsulates piping.
- E. For preformed insulating units, provide sizes to fit applications indicated and selected from Manufacturer's standard thicknesses, widths, and lengths. Apply single layer of insulation units to produce thickness indicated unless multiple layers are otherwise shown or required to make up total thickness.

3.4 INSTALLATION OF PERIMETER AND UNDER-SLAB INSULATION

- A. On vertical surfaces, set insulation units in adhesive applied according to Manufacturer's written instructions. Use adhesive recommended by insulation Manufacturer.
 - 1. If not otherwise indicated, extend insulation a minimum of 36 inches below exterior grade line.
- B. On horizontal surfaces, loosely lay insulation units according to Manufacturer's written instructions. Stagger end joints and tightly abut insulation units.
- C. Protect below-grade insulation on vertical surfaces from damage during backfilling by applying protection course with joints butted. Set in adhesive according to insulation Manufacturer's written instructions.
- D. Protect top surface of horizontal insulation from damage during concrete work by applying protection course with joints butted.

3.5 INSTALLATION OF GENERAL BUILDING INSULATION

- A. Apply insulation units to substrates by method indicated, complying with Manufacturer's written instructions. If no specific method is indicated, bond units to substrate with adhesive or use mechanical anchorage to provide permanent placement and support of units.

- B. Seal joints between insulation units by applying adhesive, mastic, or sealant to edges of each unit to form a tight seal as units are shoved into place. Fill voids in completed installation with adhesive, mastic, or sealant as recommended by insulation Manufacturer.
- C. Install board insulation on concrete substrates by adhesively attached, spindle-type insulation anchors as follows:
 - 1. Fasten insulation anchors to concrete substrates with insulation anchor adhesive according to anchor Manufacturer's written instructions. Space anchors according to insulation Manufacturer's written instructions for insulation type, thickness, and application indicated.
 - 2. After adhesive has dried, install board insulation by pressing insulation into position over spindles and securing it tightly in place with insulation-retaining washers, taking care not to compress insulation below indicated thickness.
 - 3. Where insulation will not be covered by other building materials, apply capped washers to tips of spindles.

3.6 INSTALLATION OF VAPOR RETARDERS

- A. General: Extend vapor retarder to extremities of areas to be protected from vapor transmission.
- B. Seal joints caused by pipes, conduits, electrical boxes, and similar items penetrating vapor retarders with vapor-retarder tape to create an airtight seal between penetrating objects and vapor retarder.
- C. Repair tears or punctures in vapor retarders immediately before concealment by other work. Cover with vapor-retarder tape or another layer of vapor retarder.

3.7 PROTECTION

- A. Protect installed insulation and vapor retarders from damage due to harmful weather exposures, physical abuse, and other causes. Provide temporary coverings or enclosures where insulation is subject to abuse and cannot be concealed and protected by permanent construction immediately after installation.

** END OF SECTION **

**SECTION 240070
THERMAL TESTING**

PART 1 - GENERAL

1.1 Messiah College requires the below guidelines for thermal testing for any new or additions to buildings

- A. ASTM C1060-11a Standard Practice for Thermographic Inspection of Insulations in Envelope Cavities of Frame Buildings
- B. ASTM E11186-03 (2009) Standard Practice for Air Leakage Site Detection in Building Envelopes and Air Barrier Systems

**** END OF SECTION ****

SECTION 240080 INSULATED METAL WALL PANELS

1.1 SUMMARY

A. Section Includes:

1. Foamed-insulation-core metal wall panels.

1.2 PREINSTALLATION MEETINGS

A. Pre-installation Conference: Conduct conference at Project site.

1. Meet with Owner, Owner's insurer if applicable, metal panel Installer, metal panel manufacturer's representative, structural-support Installer, and installers whose work interfaces with or affects metal panels, including installers of doors, windows, and louvers.
2. Review and finalize construction schedule and verify availability of materials, Installer's personnel, equipment, and facilities needed to make progress and avoid delays.
3. Review methods and procedures related to metal panel installation, including manufacturer's written instructions.
4. Examine support conditions for compliance with requirements, including alignment between and attachment to structural members.
5. Review flashings, special siding details, wall penetrations, openings, and condition of other construction that affect metal panels.
6. Review governing regulations and requirements for insurance, certificates, and tests and inspections if applicable.
7. Review temporary protection requirements for metal panel assembly during and after installation.
8. Review procedures for repair of metal panels damaged after installation.
9. Document proceedings, including corrective measures and actions required, and furnish copy of record to each participant.

1.3 ACTION SUBMITTALS

A. Product Data: For each type of product.

1. Include construction details, material descriptions, dimensions of individual components and profiles, and finishes for each type of panel and accessory.

B. Shop Drawings:

1. Include fabrication and installation layouts of metal panels; details of edge conditions, joints, panel profiles, corners, anchorages, attachment system, trim, flashings, closures, and accessories; and special details.

2. Accessories: Include details of the flashing, trim, and anchorage systems, at a scale of not less than 1-1/2 inches per 12 inches.
- C. Samples for Verification: For each type of exposed finish, prepared on Samples of size indicated below.
1. Metal Panels: 12 inches long by actual panel width. Include fasteners, closures, and other metal panel accessories.

1.4 INFORMATIONAL SUBMITTALS

- A. Qualification Data: For Installer.
- B. Product Test Reports: For each product, tests performed by a qualified testing agency.
- C. Field quality-control reports.
- D. Sample Warranties: For special warranties.

1.5 CLOSEOUT SUBMITTALS

- A. Maintenance Data: For metal panels to include in maintenance manuals.

1.6 QUALITY ASSURANCE

- A. Installer Qualifications: An entity that employs installers and supervisors who are trained and approved by manufacturer.
- B. Mockups: Build mockups to verify selections made under Sample submittals and to demonstrate aesthetic effects and set quality standards for fabrication and installation.
 1. Build mockup of typical metal panel assembly as shown on Drawings, 2'-8" high x 6'-0" long, including corner, supports, attachments, and accessories.
 2. Water-Spray Test: Conduct water-spray test of metal panel assembly mockup, testing for water penetration according to AAMA 501.2.
 3. Subject to compliance with requirements, approved mockups may become part of the completed Work if undisturbed at time of Substantial Completion.

1.7 DELIVERY, STORAGE, AND HANDLING

- A. Deliver components, metal panels, and other manufactured items so as not to be damaged or deformed. Package metal panels for protection during transportation and handling.
- B. Unload, store, and erect metal panels in a manner to prevent bending, warping, twisting, and surface damage.

- C. Stack metal panels horizontally on platforms or pallets, covered with suitable weather-tight and ventilated covering. Store metal panels to ensure dryness, with positive slope for drainage of water. Do not store metal panels in contact with other materials that might cause staining, denting, or other surface damage.
- D. Retain strippable protective covering on metal panels during installation.

1.8 FIELD CONDITIONS

- A. Weather Limitations: Proceed with installation only when existing and forecasted weather conditions permit assembly of metal panels to be performed according to manufacturers' written instructions and warranty requirements.

1.9 COORDINATION

- A. Coordinate metal panel installation with rain drainage work, flashing, trim, construction of soffits, and other adjoining work to provide a leak-proof, secure, and noncorrosive installation.

1.10 WARRANTY

- A. Special Warranty: Manufacturer's standard form in which manufacturer agrees to repair or replace components of metal panel systems that fail in materials or workmanship within specified warranty period.
 - 1. Failures include, but are not limited to, the following:
 - a. Structural failures including rupturing, cracking, or puncturing.
 - b. Deterioration of metals and other materials beyond normal weathering.
 - 2. Warranty Period: Two years from date of Substantial Completion.
- B. Special Warranty on Panel Finishes: Manufacturer's standard form in which manufacturer agrees to repair finish or replace metal panels that show evidence of deterioration of factory-applied finishes within specified warranty period.
 - 1. Exposed Panel Finish: Deterioration includes, but is not limited to, the following:
 - a. Color fading more than 5 Hunter units when tested according to ASTM D 2244.
 - b. Chalking in excess of a No. 8 rating when tested according to ASTM D 4214.
 - c. Cracking, checking, peeling, or failure of paint to adhere to bare metal.
 - 2. Finish Warranty Period: 20 years from date of Substantial Completion.

PART 2 - PRODUCTS

2.1 PERFORMANCE REQUIREMENTS

- A. Structural Performance: Provide metal panel systems capable of withstanding the effects of the following loads, based on testing according to ASTM E 72:
 - 1. Deflection Limits: For wind loads, no greater than 1/240 of the span.
- B. Air Infiltration: Air leakage of not more than 0.06 cfm/sq. ft. when tested according to ASTM E 283 at the following test-pressure difference:
 - 1. Test-Pressure Difference: 6.24 lbf/sq. ft.
- C. Water Penetration under Static Pressure: No water penetration when tested according to ASTM E 331 at the following test-pressure difference:
 - 1. Test-Pressure Difference: 6.24 lbf/sq. ft.
- D. Thermal Movements: Allow for thermal movements from ambient and surface temperature changes by preventing buckling, opening of joints, overstressing of components, failure of joint sealants, failure of connections, and other detrimental effects. Base calculations on surface temperatures of materials due to both solar heat gain and nighttime-sky heat loss.
 - 1. Temperature Change (Range): 120 deg F, ambient; 180 deg F, material surfaces.
- E. Fire-Test-Response Characteristics: Provide metal wall panels and system components with the following fire-test-response characteristics, as determined by testing identical panels and system components per test method indicated below by UL or another testing and inspecting agency acceptable to authorities having jurisdiction. Identify products with appropriate markings of applicable testing agency.
 - 1. Fire-Resistance Characteristics: Provide materials and construction tested for fire resistance per ASTM E 119.
 - 2. Intermediate-Scale Multistory Fire Test: Tested mockup, representative of completed multistory wall assembly of which wall panel is a part, complies with NFPA 285 for test method and required fire-test-response characteristics of exterior non-load-bearing wall panel assemblies.
 - 3. Radiant Heat Exposure: No ignition when tested according to NFPA 268.
 - 4. Potential Heat: Acceptable level when tested according to NFPA 259.
 - 5. Surface-Burning Characteristics: Provide wall panels with a flame-spread index of 25 or less and a smoke-developed index of 450 or less, per ASTM E 84.

2.2 FOAMED-INSULATION-CORE METAL WALL PANELS

- A. General: Provide factory-formed and -assembled metal wall panels fabricated from two metal facing sheets and insulation core foamed in place during fabrication, and with joints between

panels designed to form weather-tight seals. Include accessories required for weather-tight installation.

1. Insulation Core: Polyurethane foam using a non-CFC blowing agent, with maximum flame-spread and smoke-developed indexes of 25 and 450, respectively.
 - a. Closed-Cell Content: 92 percent when tested according to ASTM D 6226.
 - b. Density: 2.0 to 2.6 lb/cu. ft. when tested according to ASTM D 1622.
 - c. Compressive Strength: Minimum 20 psi when tested according to ASTM D 1621.
 - d. Shear Strength: 26 psi when tested according to ASTM C 273.

B. Concealed-Fastener, Foamed-Insulation-Core Metal Wall Panels: Formed with tongue-and-groove panel edges; designed for sequential installation by interlocking panel edges and mechanically attaching panels to supports using concealed clips or fasteners.

1. Products: Subject to compliance with requirements, available products that may be incorporated into the Work include, but are not limited to, the following:
 - a. CENTRIA Architectural Systems.
 - b. Kingspan.
 - c. Basis-of-Design Product: **Metl-Span LLC; CF Flat Architectural CF-36A** Insulated Metal Wall Panel with light mesa profile liner.
2. Premium Metallic Coated Steel Sheet: Facings of zinc-coated (galvanized) steel sheet complying with ASTM A 653, G90 (Z275) coating designation, or aluminum-zinc alloy-coated steel sheet complying with ASTM A 792, Class AZ50 (Class AZM150) coating designation; structural quality. Pre-painted by the coil-coating process to comply with ASTM A 755.
 - a. Nominal Thickness: 22 gage.
 - b. Exterior Finish: Two-coat premium metallic fluoropolymer.
 - 1) Color: **Metlspan Dark Gray Metallic.**
3. Backer Board: On back side of exterior facing.
4. Snap-on Batten: Same material, finish, and color as exterior facings of wall panels.
5. Panel Coverage: **36** inches nominal.
6. Panel Thickness: **2.5** inches.
7. Thermal-Resistance Value (R-Value): **R18.71** according to ASTM C 1363.

2.3 MISCELLANEOUS MATERIALS

- A. Miscellaneous Metal Sub-framing and Furring: ASTM C 645, cold-formed, metallic-coated steel sheet, ASTM A 653, G90 (Z275 hot-dip galvanized) coating designation or ASTM A 792, Class AZ50 (Class AZM150) aluminum-zinc-alloy coating designation unless otherwise indicated. Provide manufacturer's standard sections as required for support and alignment of metal panel system.
- B. Panel Accessories: Provide components required for a complete, weather-tight panel system including trim, copings, fasciae, mullions, sills, corner units, clips, flashings, sealants, gaskets,

fillers, closure strips, and similar items. Match material and finish of metal panels unless otherwise indicated.

1. Closures: Provide closures at eaves and rakes, fabricated of same metal as metal panels.
 2. Backing Plates: Provide metal backing plates at panel end splices, fabricated from material recommended by manufacturer.
 3. Closure Strips: Closed-cell, expanded, cellular, rubber or cross-linked, polyolefin-foam or closed-cell laminated polyethylene; minimum 1-inch- thick, flexible closure strips; cut or pre-molded to match metal panel profile. Provide closure strips where indicated or necessary to ensure weather-tight construction.
- C. Backer Board: Hardboard complying with ANSI A135.4, Class 1 tempered, 1/4 inch thick unless otherwise indicated.
- D. Flashing and Trim: Provide flashing and trim formed from same material as metal panels as required to seal against weather and to provide finished appearance. Locations include, but are not limited to, bases, drips, sills, jambs, corners, end walls, framed openings, rakes, fasciae, parapet caps, soffits, reveals, and fillers. Finish flashing and trim with same finish system as adjacent metal panels.
- E. Panel Fasteners: Self-tapping screws designed to withstand design loads. Provide exposed fasteners with heads matching color of metal panels by means of plastic caps or factory-applied coating. Provide EPDM or PVC sealing washers for exposed fasteners.
- F. Panel Sealants: Provide sealant type recommended by manufacturer that are compatible with panel materials, are non-staining, and do not damage panel finish.
1. Sealant Tape: Pressure-sensitive, 100 percent solids, gray polyisobutylene compound sealant tape with release-paper backing. Provide permanently elastic, non-sag, nontoxic, non-staining tape 1/2 inch wide and 1/8 inch thick.
 2. Joint Sealant: ASTM C 920; elastomeric polyurethane or silicone sealant; of type, grade, class, and use classifications required to seal joints in metal panels and remain weather-tight; and as recommended in writing by metal panel manufacturer.
 3. Butyl-Rubber-Based, Solvent-Release Sealant: ASTM C 1311.

2.4 FABRICATION

- A. General: Fabricate and finish metal panels and accessories at the factory, by manufacturer's standard procedures and processes, as necessary to fulfill indicated performance requirements demonstrated by laboratory testing. Comply with indicated profiles and with dimensional and structural requirements.
- B. Provide panel profile, including major ribs and intermediate stiffening ribs, if any, for full length of panel.
- C. Fabricate metal panel joints with factory-installed captive gaskets or separator strips that provide a weather-tight seal and prevent metal-to-metal contact, and that minimize noise from movements.

- D. Sheet Metal Flashing and Trim: Fabricate flashing and trim to comply with manufacturer's recommendations and recommendations in SMACNA's "Architectural Sheet Metal Manual" that apply to design, dimensions, metal, and other characteristics of item indicated.
1. Form exposed sheet metal accessories that are without excessive oil canning, buckling, and tool marks and that are true to line and levels indicated, with exposed edges folded back to form hems.
 2. Seams for Other Than Aluminum: Fabricate nonmoving seams in accessories with flat-lock seams. Tin edges to be seamed, form seams, and solder.
 3. Sealed Joints: Form non-expansion, but movable, joints in metal to accommodate sealant and to comply with SMACNA standards.
 4. Conceal fasteners and expansion provisions where possible. Exposed fasteners are not allowed on faces of accessories exposed to view.
 5. Fabricate cleats and attachment devices from same material as accessory being anchored or from compatible, noncorrosive metal recommended in writing by metal panel manufacturer.
 - a. Size: As recommended by SMACNA's "Architectural Sheet Metal Manual" or metal wall panel manufacturer for application but not less than thickness of metal being secured.

2.5 FINISHES

- A. Protect mechanical and painted finishes on exposed surfaces from damage by applying a strippable, temporary protective covering before shipping.
- B. Appearance of Finished Work: Variations in appearance of abutting or adjacent pieces are acceptable if they are within one-half of the range of approved Samples. Noticeable variations in same piece are not acceptable. Variations in appearance of other components are acceptable if they are within the range of approved Samples and are assembled or installed to minimize contrast.
- C. Steel Panels and Accessories:
1. Two-Coat Premium Fluoropolymer: AAMA 621. Fluoropolymer finish containing not less than 70 percent PVDF resin by weight in color coat. Prepare, pre-treat, and apply coating to exposed metal surfaces to comply with coating and resin manufacturers' written instructions.
 2. Concealed Finish: Apply pretreatment and manufacturer's standard white or light-colored acrylic or polyester backer finish consisting of prime coat and wash coat with a minimum total dry film thickness of 0.5 mil.

PART 3 - EXECUTION

3.1 EXAMINATION

- A. Examine substrates, areas, and conditions, with Installer present, for compliance with requirements for installation tolerances, metal panel supports, and other conditions affecting performance of the Work.
 - 1. Examine wall framing to verify that girts, angles, channels, studs, and other structural panel support members and anchorage have been installed within alignment tolerances required by metal wall panel manufacturer.
 - 2. Examine wall sheathing to verify that sheathing joints are supported by framing or blocking and that installation is within flatness tolerances required by metal wall panel manufacturer.
 - a. Verify that air- or water-resistive barriers have been installed over sheathing or backing substrate to prevent air infiltration or water penetration.
- B. Examine roughing-in for components and systems penetrating metal panels to verify actual locations of penetrations relative to seam locations of metal panels before installation.
- C. Proceed with installation only after unsatisfactory conditions have been corrected.

3.2 PREPARATION

- A. Miscellaneous Supports: Install subframing, furring, and other miscellaneous panel support members and anchorages according to ASTM C 754 and metal panel manufacturer's written recommendations.

3.3 METAL PANEL INSTALLATION

- A. General: Install metal panels according to manufacturer's written instructions in orientation, sizes, and locations indicated. Install panels perpendicular to supports unless otherwise indicated. Anchor metal panels and other components of the Work securely in place, with provisions for thermal and structural movement.
 - 1. Shim or otherwise plumb substrates receiving metal panels.
 - 2. Flash and seal metal panels at perimeter of all openings. Fasten with self-tapping screws. Do not begin installation until air- or water-resistive barriers and flashings that will be concealed by metal panels are installed.
 - 3. Install screw fasteners in predrilled holes.
 - 4. Locate and space fastenings in uniform vertical and horizontal alignment.
 - 5. Install flashing and trim as metal panel work proceeds.
 - 6. Locate panel splices over, but not attached to, structural supports. Stagger panel splices and end laps to avoid a four-panel lap splice condition.
 - 7. Align bottoms of metal panels and fasten with blind rivets, bolts, or self-tapping screws. Fasten flashings and trim around openings and similar elements with self-tapping screws.
 - 8. Provide weather-tight escutcheons for pipe- and conduit-penetrating panels.

- B. Fasteners:
 - 1. Steel Panels: Use stainless-steel fasteners for surfaces exposed to the exterior; use galvanized-steel fasteners for surfaces exposed to the interior.
- C. Metal Protection: Where dissimilar metals contact each other or corrosive substrates, protect against galvanic action as recommended in writing by metal panel manufacturer.
- D. Joint Sealers: Install gaskets, joint fillers, and sealants where indicated and where required for weather-tight performance of metal wall panel assemblies. Provide types of gaskets, fillers, and sealants indicated by metal panel manufacturer; or, if not indicated, provide types recommended by metal wall panel manufacturer.
 - 1. Seal metal wall panel end laps with double beads of tape or sealant, full width of panel. Seal side joints where recommended by metal wall panel manufacturer.
 - 2. Prepare joints and apply sealants to comply with requirements in Section 241080 "Joint Sealants."

3.4 INSULATED METAL WALL PANEL INSTALLATION

- A. General: Apply continuous ribbon of sealant to panel joint on concealed side of insulated metal wall panels as vapor seal; apply sealant to panel joint on exposed side of panels for weather seal.
 - 1. Fasten foamed-insulation-core metal wall panels to supports with fasteners at each lapped joint at location and spacing and with fasteners recommended by manufacturer.
 - 2. Apply panels and associated items true to line for neat and weather-tight enclosure. Avoid "panel creep" or application not true to line.
 - 3. Provide metal-backed washers under heads of exposed fasteners on weather side of insulated metal wall panels.
 - 4. Locate and space exposed fasteners in uniform vertical and horizontal alignment. Use proper tools to obtain controlled uniform compression for positive seal without rupture of washer.
 - 5. Provide sealant tape at lapped joints of insulated metal wall panels and between panels and protruding equipment, vents, and accessories.
 - 6. Apply a continuous ribbon of sealant tape to panel side laps and elsewhere as needed to make panels weather-tight.
 - 7. Apply snap-on battens to exposed-fastener, insulated-core metal wall panel seams to conceal fasteners.
- B. Foamed-Insulation-Core Metal Wall Panels: Fasten metal wall panels to supports with concealed clips at each joint at location and spacing and with fasteners recommended by manufacturer. Fully engage tongue and groove of adjacent panels.
 - 1. Install clips to supports with self-tapping fasteners.
- C. Accessory Installation: Install accessories with positive anchorage to building and weather-tight mounting, and provide for thermal expansion. Coordinate installation with flashings and other components.

1. Install components required for a complete metal panel system including trim, copings, corners, seam covers, flashings, sealants, gaskets, fillers, closure strips, and similar items. Provide types indicated by metal panel manufacturer; or, if not indicated, provide types recommended by metal panel manufacturer.
- D. Flashing and Trim: Comply with performance requirements, manufacturer's written installation instructions, and SMACNA's "Architectural Sheet Metal Manual." Provide concealed fasteners where possible, and set units true to line and level. Install work with laps, joints, and seams that are permanently watertight.
1. Install exposed flashing and trim that is without buckling and tool marks, and that is true to line and levels indicated, with exposed edges folded back to form hems. Install sheet metal flashing and trim to fit substrates and to achieve waterproof performance.
 2. Expansion Provisions: Provide for thermal expansion of exposed flashing and trim. Space movement joints at a maximum of 10 feet with no joints allowed within 24 inches of corner or intersection. Where lapped expansion provisions cannot be used or would not be sufficiently waterproof, form expansion joints of intermeshing hooked flanges, not less than 1 inch deep, filled with mastic sealant (concealed within joints).

3.5 FIELD QUALITY CONTROL

- A. Testing Agency: **Owner will engage** a qualified testing agency to perform tests and inspections.
- B. Water-Spray Test: After installation, test area of assembly as directed by Owner for water penetration according to AAMA 501.2.
- C. Manufacturer's Field Service: Engage a factory-authorized service representative to test and inspect completed metal wall panel installation, including accessories.
- D. Metal wall panels will be considered defective if they do not pass test and inspections.
- E. Additional tests and inspections, at Contractor's expense, are performed to determine compliance of replaced or additional work with specified requirements.
- F. Prepare test and inspection reports.

3.6 CLEANING AND PROTECTION

- A. Remove temporary protective coverings and strippable films, if any, as metal panels are installed, unless otherwise indicated in manufacturer's written installation instructions. On completion of metal panel installation, clean finished surfaces as recommended by metal panel manufacturer. Maintain in a clean condition during construction.
- B. After metal panel installation, clear weep holes and drainage channels of obstructions, dirt, and sealant.
- C. Replace metal panels that have been damaged or have deteriorated beyond successful repair by finish touchup or similar minor repair procedures.

** END OF SECTION **

SECTION 241010 GLAZING

PART 1 - GENERAL

1.1 SUMMARY

A. Section includes glass and glazing for:

1. Float glass.
2. Tempered glass.
3. Insulated units.
4. Fire rated safety glass.
5. Frosted glass.
6. Framed mirrors.

B. Related Sections:

1. Section 241080 "Joint Sealants."
2. Section 100010 "Hollow Metal Doors and Frames."
3. Section 100070 "Aluminum-Framed Entrances and Storefronts."

1.2 SUBMITTALS

A. Submit the following supporting data:

1. **Product Data:** Submit Manufacturer's technical data for each glazing material and fabricated glass product required, including installation and maintenance instructions.
2. **Compatibility and Adhesion Test Report:** Submit statement from sealant Manufacturer indicating that glass and glazing materials have been tested for compatibility and adhesion with glazing sealants and interpreting test results relative to material performance, including recommendations for primers and substrate preparation needed to obtain adhesion.

B. Samples: Submit, for verification purposes, 12" square samples of each type of glass indicated except for clear single pane units, and 12" long samples of each color required (except black) for each type of sealant or gasket exposed to view. Install sealant or gasket sample between two strips of material representative of adjoining framing system in color. Sample requirement may be waived by Owner's Representative at their discretion.

1.3 QUALITY ASSURANCE

A. Glazing Standards: Comply with recommendations of Flat Glass Marketing Association (FGMA) "Glazing Manual" and "Sealant Manual" except where more stringent requirements are indicated. Refer to those publications for definitions of glass and glazing terms not otherwise defined in this section or other referenced standards.

- B. **Installer Qualifications:** An experienced installer who has completed glazing similar in material, design, and extent to that indicated for this Project; whose work has resulted in glass installations with a record of successful in-service performance; and who employs glass installers for this Project who are certified under the National Glass Association Glazier Certification Program as Level 2 (Senior Glaziers) or Level 3 (Master Glaziers).
- C. **Safety Glazing Products:** Comply with testing requirements in 16 CFR 1201 and, for wired glass, ANSI Z97.1.
 - 1. Subject to compliance with requirements, obtain safety glazing products permanently marked with certification label of the Safety Glazing Certification Council or another certification agency acceptable to authorities having jurisdiction.
- D. **Glazing Publications:** Comply with published recommendations of glass product Manufacturers and organizations below, unless more stringent requirements are indicated. Refer to these publications for glazing terms not otherwise defined in this Section or in referenced standards.
 - 1. **IGMA Publication for Insulating Glass:** SIGMA TM-3000, "Glazing Guidelines for Sealed Insulating Glass Units."
- E. **Single Source Responsibility for Glass:** To ensure consistent quality of appearance and performance, provide materials produced by a single Manufacturer or fabricator for each kind and condition of glass indicated and composed of primary glass obtained from a single source for each type and class required.

1.4 DELIVERY, STORAGE, AND HANDLING

- A. **Protect glass and glazing materials during delivery, storage and handling to comply with Manufacturer's directions and as required to prevent edge damage to glass, and damage to glass and glazing materials from effects of moisture including condensation, of temperature changes, of direct exposure to sun, and from other causes.**

1.5 PROJECT CONDITIONS

- A. **Environmental Conditions:** Do not proceed with glazing when ambient and substrate temperature conditions are outside the limits permitted by glazing material Manufacturer or when joint substrates are wet due to rain, frost, condensation or other causes.

1.6 WARRANTY

- A. **General:** Warranties shall be in addition to, and not a limitation of, other rights the Owner may have.
- B. **All material shall be free from Manufacturer defects and installation workmanship. Any material or workmanship judged to be defective shall be replaced at no cost to the Owner.**
- C. **Insulating glass units shall be jointly guaranteed for a period of **10 years** by the Manufacturer and installer against obstruction of vision between interior glass surfaces caused by failure of**

the hermetic seal. Units damaged during guarantee period shall be replaced at no cost to the Owner.

PART 2 - PRODUCTS

2.1 GENERAL

- A. All glass shall be new material, graded under Federal Specifications DD-G-451-D-451D
- B. All glass in related area shall be from one Manufacturer.

2.2 GLASS MATERIALS

- A. Refer to Drawings for location of glass types.
- B. Manufacturer: Pilkington, Guardian, or PPG, Low E, 0.29 U Winter Value, 0.38 SHGC Summer Value.
 - 1. Color: **Clear.**
- C. Insulated Glass Standard: Provide pre-assembled sealed insulating glass units that comply with ASTM E774.
- D. Glass in Doors and Windows: Provide glazing units as outlined below. Refer to Elevations for locations of the following glazing panel designations.

1. Glazing Types (exterior):

IGL 1" Insulated Clear Vision Glass Unit.
1/4" outboard clear vision glass, 1/2" airspace, 1/4" clear Low E inboard glass.
Typical exterior glass units above 6'-0" AFF.

ITGL 1" Insulated Clear Tempered Vision Glass Unit.
1/4" outboard clear vision tempered glass, 1/2" airspace, 1/4" clear Low E tempered inboard glass.
Typical exterior glass units below 6'-0" AFF.

IFLTGL 1" Insulated 5/16" Firelite Plus Tempered Glass Unit.
Typical exterior fire rated units.

Glazing Types (interior):

FLTGL 5/16" Firelite Plus Tempered Glass Unit.
Typical interior borrowed lites (rated applications).

TGL 1/2" Clear Tempered Glass Unit.
Typical interior borrowed lites (non rated applications).

2.3 FIRE RESISTIVE GLAZING PRODUCTS

A. Manufacturers:

1. 5/16" thick tempered, "Premium **FireLite Plus**" distributed by Technical Glass Products (800-426-0279).
2. 1/4" thick tempered, "Pyroshield Plus" distributed by Technical Glass Products (800-426-0279).
3. 5/16" thick tempered, "Pyroguard Clear"; Old Castle Glass, a CRH Company (800-899-8455).

B. Fire-Resistive Tempered Ceramic Glazing Material: Proprietary product in the form of clear flat sheets psf, permanently labeled with appropriate marks of testing and inspecting agency, acceptable to authorities having jurisdiction, showing product complies with fire-resistive installation indicated, and as follows:

1. Safety Glass: Shall conform to ANSI Z97.1, ASTM C1048, and Federal Standard CPSC 16 SFR 1201.
2. Polished on both surfaces, transparent with minimum visible light transmission of 85 percent.
3. Positive Pressure: Shall meet requirements of positive pressure test standards UL 10C.

2.4 MIRRORS

A. Manufacturers:

1. Binswanger Mirror, Division of Vitro America (800-238-6057)
2. Guardian Consolidated, (276-236-5196)
3. Gardner Glass Products (800-334-7267)

B. Mirror glazing "select" quality float glass complying with ASTM C1036 and CPSC 16 CFR 1201, 1/4" thick.

C. Silvering: Provide electro-deposited silvering in two coats.

D. Edges ground smooth and polished.

E. Frames: Provide framed mirror units in Restrooms. Frame type to be **selected by Owner** from manufacturer's full range of frame types.

F. Concealed Mirror Clips:

1. Manufacturers:

- a. Knappe & Vogt (800-253-1561).
- b. Continuous clip at base and top to secure framed mirror to wall. Clip can not be visible to the room occupant.
- c. Approved substitution

2.5 ELASTOMERIC GLAZING SEALANTS AND PREFORMED GLAZING TAPES

A. General: Provide products of type indicated and complying with the following requirements:

1. Compatibility: Select glazing sealants and tapes of proven compatibility with other materials with which they will come into contact, including glass products, seals of insulating glass units, and glazing channel substrates, under conditions of installation and service, as demonstrated by testing and field experience.
2. Suitability: Comply with recommendations of sealant and glass Manufacturers for selection of glazing sealants and tapes which have performance characteristics suitable for applications indicated and conditions at time of installation.
3. Elastomeric Sealant Standard: Provide Manufacturer's standard chemically curing, elastomeric sealant of base polymer indicated which complies with ASTM C 920 requirements, including those for Type, Grade, Class and Uses.
4. Colors: Provide color of exposed sealants indicated or, if not otherwise indicated, as selected by Owner's Representative from Manufacturer's standard colors.

B. Pre-formed Butyl Polyisobutylene Glazing Tape: Provide Manufacturer's standard solvent-free butyl polyisobutylene formulation with a solids content of 100 percent; complying with AAMA A 804.1; in extruded tape form; non-staining and non-migrating in contact with nonporous surfaces; packaged on rolls with a release paper on one side; with or without continuous spacer rod as recommended by Manufacturers of tape and glass for application indicated.

C. Sealants: Provide structural and weather-seal sealants recommended by the Manufacturer of the glazing system.

1. Manufacturers:

- a. GE Silicones (800-255-8886)
- b. Tremco, Inc., Sealant/Weatherproofing Division, an RPM Company (800-562-2728)

2. Refer to Section 241080 "Joint Sealants."

D. Spacers, Setting Blocks, Gaskets, and Bond Breakers: Provide the curtain wall Manufacturer's permanent non-migrating types compatible with sealants and suitable for joint movement and sealing requirements.

2.6 MISCELLANEOUS GLAZING MATERIALS

- A. Compatibility: Provide materials with proven record of compatibility with surfaces contacted in installation.
- B. Cleaners, Primers and Sealers: Type recommended by sealant or gasket Manufacturer.
- C. Setting Blocks: Neoprene, EPDM or silicone blocks as required for compatibility with glazing sealants, 80 to 90 Shore A durometer hardness.
- D. Spacers: Neoprene, EPDM or silicone blocks, or continuous extrusions, as required for compatibility with glazing sealant, of size, shape and hardness recommended by glass and sealant Manufacturers for application indicated.
- E. Edge Blocks: Neoprene, EPDM or silicone blocks as required for compatibility with glazing sealant, of size and hardness required to limit lateral movement (side-walking) of glass.
- F. Compressible Filler Rods: Closed-cell or waterproof-jacketed rod stock of synthetic rubber or plastic foam, flexible and resilient, with 5-10 psi compression strength for 25 percent deflection.

PART 3 - EXECUTION

3.1 EXAMINATION

- A. Require Glazier to inspect work of glass framing erector for compliance with manufacturing and installation tolerances, including those for size, squareness, offsets at corners; for presence and functioning of weep system; for existence of minimum required face or edge clearances; and for effective sealing of joinery. Obtain Glazier's written report listing conditions detrimental to performance of glazing work. Do not allow glazing work to proceed until unsatisfactory conditions have been corrected.

3.2 PREPARATION

- A. Clean glazing channels and other framing members to receive glass, immediately before glazing. Remove coatings which are not firmly bonded to substrates. Remove lacquer from metal surfaces where elastomeric sealants are indicated for use.

3.3 GLAZING, GENERAL

- A. Comply with combined printed recommendations of glass Manufacturers, of Manufacturers of sealants, gaskets and other glazing materials, except where more stringent requirements are indicated, including those of referenced glazing standards.
- B. Protect glass from edge damage during handling and installation; use a rolling block in rotating glass units to prevent damage to glass corners. Do not impact glass with metal framing. Use suction cups to shift glass units within openings; do not raise or drift glass with a pry bar. Rotate glass with flares or bevels along one horizontal edge which would occur in vicinity of setting blocks so that these are located at top of opening. Remove from project and dispose of

glass units with edge damage or other imperfections of kind that, when installed, weakens glass and impairs performance and appearance.

- C. Apply primers to joint surfaces where required for adhesion of sealants, as determined by preconstruction sealant-substrate testing.
- D. Anchor components securely in place in the manner indicated. Shim and allow for movement resulting from changes in thermal conditions. Provide separators and isolators to prevent corrosion, electrolytic deterioration, and "freeze-up" of moving joints.
- E. Glazing: Inspect glass and framing for compliance with manufacturing and installation tolerances, including size, squareness, and offsets at corners; for existence of minimum face or edge clearances; and for effective sealing of joinery.
 - 1. Avoid point loading of glass. Do not proceed with glazing work until unsatisfactory conditions have been corrected. Do not field-cut glass.
- F. Erection Tolerances: Install curtain wall components plumb, level, accurately aligned, and located in reference to column lines and floor levels. Erection tolerances indicated below are the maximum allowable for both no-load and full-load conditions and are not cumulative. Adjust work to conform to the following tolerances:
 - 1. Plumb: 1/8 inch in 10 feet; 1/4 inch in 40 feet.
 - 2. Level: 1/8 inch in 20 feet; 1/4 inch in 40 feet.
 - 3. Alignment: Limit offset of member alignment to 1/16 inch where surfaces are flush or less than 1/2 inch out of flush and separated by less than 3 inches by protruding work; otherwise limit offsets to 1/8 inch.
 - 4. Location: 3/8 inch maximum deviation from the measured theoretical location of any member at any location.

3.4 GLAZING

- A. Install setting blocks of proper size in sill rabbet, located one quarter of glass width from each corner, but with edge nearest corner not closer than 6" from corner, unless otherwise required. Set blocks in thin course of sealant which is acceptable for heel bead use.
- B. Provide spacers inside and out, of correct size and spacing to preserve required face clearances, for glass sizes larger than 50 united inches (length plus height), except where gaskets or glazing tapes with continuous spacer rods are used for glazing. Provide 1/8" minimum bite of spacers on glass and use thickness equal to sealant width, except with sealant tape use thickness slightly less than final compressed thickness of tape.
- C. Provide edge blocking to comply with requirements of referenced glazing standard, except where otherwise required by glass unit Manufacturer. Set units of glass in each series with uniformity of pattern, draw, bow and similar characteristics.
- D. Provide compressible filler rods or equivalent back-up material, as recommended by sealant and glass Manufacturers, to prevent sealant from extruding into glass channel weep systems and from adhering to joints back surface as well as to control depth of sealant for optimum

performance, unless otherwise indicated. Force sealants into glazing channels to eliminate voids and to ensure complete "wetting" or bond of sealant to glass and channel surfaces.

3.5 MIRROR INSTALLATION

- A. Do not install mirrors on freshly painted walls, or where airborne solvents, heavy-duty cleaners, etc., are in the air. Sub-surfaces shall be allowed to cure for a minimum of 72 hours.
- B. Use continuous concealed clips at top and bottom attached to mirror frames.

3.6 CLEANING AND PROTECTION

- A. Protect exterior glass from breakage immediately upon installation by use of crossed streamers attached to framing and held away from glass. Do not apply markers to surfaces of glass. Remove nonpermanent labels and clean surfaces.
- B. Protect glass from contact with contaminating substances resulting from construction operations. If, despite such protection, contaminating substances do come into contact with glass, remove immediately by method recommended by glass Manufacturer.
- C. Examine glass surfaces adjacent to or below exterior concrete and other masonry surfaces at frequent intervals during construction, but not less often than once a month, for build-up of dirt, scum, alkali deposits or staining. When examination reveals presence of these forms of residue, remove by method recommended by glass Manufacturer.
- D. Remove and replace glass which is broken, chipped, cracked, abraded or damaged in other ways during construction period, including natural causes, accidents and vandalism.
- E. Wash glass on both faces not more than 4 days prior to date scheduled for inspections intended to establish date of substantial completion.

** END OF SECTION **

SECTION 241020 FIXED LOUVERS

PART 1 - GENERAL

1.1 SUMMARY

- A. Section Includes:
 - 1. Fixed, extruded-aluminum louvers.

1.2 DEFINITIONS

- A. Louver Terminology: Definitions of terms for metal louvers contained in AMCA 501 apply to this Section unless otherwise defined in this Section or in referenced standards.
- B. Horizontal Louver: Louver with horizontal blades (i.e., the axes of the blades are horizontal).
- C. Drainable-Blade Louver: Louver with blades having gutters that collect water and drain it to channels in jambs and mullions, which carry it to bottom of unit and away from opening.

1.3 ACTION SUBMITTALS

- A. Product Data: For each type of product.
 - 1. For louvers specified to bear AMCA seal, include printed catalog pages showing specified models with appropriate AMCA Certified Ratings Seals.
- B. Shop Drawings: For louvers and accessories. Include plans, elevations, sections, details, and attachments to other work. Show frame profiles and blade profiles, angles, and spacing.
 - 1. Show weep paths, gaskets, flashing, sealant, and other means of preventing water intrusion.
 - 2. Show mullion profiles and locations.
- C. Samples: For each type of metal finish required.
- D. Delegated-Design Submittal: For louvers indicated to comply with structural and seismic performance requirements, including analysis data signed and sealed by the qualified professional engineer responsible for their preparation.

1.4 INFORMATIONAL SUBMITTALS

- A. Product Test Reports: Based on evaluation of comprehensive tests performed according to AMCA 500-L by a qualified testing agency or by manufacturer and witnessed by a qualified testing agency, for each type of louver and showing compliance with performance requirements specified.

- B. Windborne-debris-impact-resistance test reports.

1.5 QUALITY ASSURANCE

- A. Welding Qualifications: Qualify procedures and personnel according to the following:
 - 1. AWS D1.2, "Structural Welding Code - Aluminum."
 - 2. AWS D1.3, "Structural Welding Code - Sheet Steel."
 - 3. AWS D1.6, "Structural Welding Code - Stainless Steel."

1.6 FIELD CONDITIONS

- A. Field Measurements: Verify actual dimensions of openings by field measurements before fabrication.

PART 2 - PRODUCTS

2.1 MANUFACTURERS

- A. Source Limitations: Obtain louvers from single source from a single manufacturer.

2.2 PERFORMANCE REQUIREMENTS

- A. Delegated Design: Design louvers, including comprehensive engineering analysis by a qualified professional engineer, using structural requirements and design criteria indicated.
- B. Structural Performance: Louvers shall withstand the effects of gravity loads and the following loads and stresses within limits and under conditions indicated without permanent deformation of louver components, noise or metal fatigue caused by louver-blade rattle or flutter, or permanent damage to fasteners and anchors. Wind pressures shall be considered to act normal to the face of the building.
 - 1. Wind Loads: Determine loads based on pressures as indicated on Drawings, but not less than 27 lbf/sq.
- C. Louver Performance Ratings: Provide louvers complying with requirements specified, as demonstrated by testing manufacturer's stock units identical to those provided, except for length and width according to AMCA 500-L.
- D. Thermal Movements: Allow for thermal movements from ambient and surface temperature changes.
 - 1. Temperature Change (Range): 120 deg F, ambient; 180 deg F, material surfaces.
- E. SMACNA Standard: Comply with recommendations in SMACNA's "Architectural Sheet Metal Manual" for fabrication, construction details, and installation procedures.

2.3 FIXED, EXTRUDED-ALUMINUM LOUVERS

A. Horizontal, Drainable-Blade Louver:

1. Manufacturers: Subject to compliance with requirements, available manufacturers offering products that may be incorporated into the Work include, but are not limited to, the following:
 - a. Air Balance Inc.; a Mestek company.
 - b. Air Flow Company, Inc.
 - c. Airolite Company, LLC (The).
 - d. All-Lite Architectural Products.
 - e. American Warming and Ventilating; a Mestek company.
 - f. Architectural Louvers; Harray, LLC.
 - g. Arrow United Industries; a division of Mestek, Inc.
 - h. Carnes Company, Inc.
 - i. Cesco Products; a division of Mestek, Inc.
 - j. Construction Specialties, Inc.
 - k. Dowco Products Group; Safe Air of Illinois.
 - l. Greenheck Fan Corporation.
 - m. Industrial Louvers, Inc.
 - n. Louvers & Dampers; a division of Mestek, Inc.
 - o. Metal Form Manufacturing, Inc.
 - p. NCA Manufacturing, Inc.
 - q. Nystrom, Inc.
 - r. Pottorff.
 - s. Reliable Products, Inc.
 - t. Ruskin Company; Tomkins PLC.
 - u. United Enertech.
 - v. Vent Products Co., Inc.
2. Louver Depth: 6 inches.
3. Frame and Blade Nominal Thickness: Not less than 0.060 inch for blades and 0.080 inch for frames.
4. Mullion Type: Exposed.
5. Louver Performance Ratings:
 - a. Free Area: Not less than 7.5 sq. ft. for 48-inch- wide by 48-inch- high louver.
 - b. Point of Beginning Water Penetration: Not less than 950 fpm.
 - c. Air Performance: Not more than 0.10-inch wg static pressure drop at 750-fpm free-area intake velocity.
 - d. Air Performance: Not more than 0.10-inch wg static pressure drop at 950-fpm free-area exhaust velocity.
6. AMCA Seal: Mark units with AMCA Certified Ratings Seal.

2.4 LOUVER SCREENS

- ### A. General: Provide screen at each exterior louver.

1. Screen Location for Fixed Louvers: Interior face.
 2. Screening Type: Bird screening.
- B. Secure screen frames to louver frames with stainless-steel machine screws, spaced a maximum of 6 inches from each corner and at 12 inches o.c.
- C. Louver Screen Frames: Fabricate with mitered corners to louver sizes indicated.
1. Metal: Same type and form of metal as indicated for louver to which screens are attached. Reinforce extruded-aluminum screen frames at corners with clips.
 2. Finish: Same finish as louver frames to which louver screens are attached.
 3. Type: Rewirable frames with a driven spline or insert.
- D. Louver Screening for Aluminum Louvers:
1. Bird Screening: Aluminum, 1/2-inch- square mesh, 0.063-inch wire.

2.5 BLANK-OFF PANELS

- A. Insulated, Blank-Off Panels: Laminated panels consisting of an insulating core surfaced on back and front with metal sheets and attached to back of louver.
1. Thickness: 2 inches.
 2. Metal Facing Sheets: Aluminum sheet, not less than 0.032-inch nominal thickness.
 3. Insulating Core: Extruded-polystyrene foam.
 4. Edge Treatment: Trim perimeter edges of blank-off panels with louver manufacturer's standard extruded-aluminum-channel frames, not less than 0.080-inch nominal thickness, with corners mitered and with same finish as panels.
 5. Seal perimeter joints between panel faces and louver frames with gaskets or sealant.
 6. Panel Finish: Same finish applied to louvers.
 7. Attach blank-off panels with clips.

2.6 MATERIALS

- A. Aluminum Extrusions: ASTM B 221, Alloy 6063-T5, T-52, or T6.
- B. Aluminum Sheet: ASTM B 209, Alloy 3003 or 5005 with temper as required for forming, or as otherwise recommended by metal producer for required finish.
- C. Fasteners: Use types and sizes to suit unit installation conditions.
1. Use hex-head or Phillips pan-head, tamper-resistant, screws for exposed fasteners unless otherwise indicated.
 2. For fastening aluminum, use aluminum or 300 series stainless-steel fasteners.
 3. For color-finished louvers, use fasteners with heads that match color of louvers.
- D. Postinstalled Fasteners for Concrete and Masonry: Torque-controlled expansion anchors, made from stainless-steel components, with capability to sustain, without failure, a load equal to 4 times the loads imposed, for concrete, or 6 times the load imposed for masonry, as determined by testing according to ASTM E 488, conducted by a qualified independent testing agency.

- E. Bituminous Paint: Cold-applied asphalt emulsion complying with ASTM D 1187.

2.7 FABRICATION

- A. Factory assemble louvers to minimize field splicing and assembly. Disassemble units as necessary for shipping and handling limitations. Clearly mark units for reassembly and coordinated installation.
- B. Maintain equal louver blade spacing, including separation between blades and frames at head and sill, to produce uniform appearance.
- C. Fabricate frames, including integral sills, to fit in openings of sizes indicated, with allowances made for fabrication and installation tolerances, adjoining material tolerances, and perimeter sealant joints.
 - 1. Frame Type: Exterior flange unless otherwise indicated.
- D. Include supports, anchorages, and accessories required for complete assembly.
- E. Provide vertical mullions of type and at spacings indicated, but not more than is recommended by manufacturer, or 72 inches o.c., whichever is less.
 - 1. Semirecessed Mullions: Where indicated, provide mullions partly recessed behind louver blades so louver blades appear continuous. Where length of louver exceeds fabrication and handling limitations, fabricate with interlocking split mullions and close-fitting blade splices designed to permit expansion and contraction.
 - 2. Exterior Corners: Prefabricated corner units with mitered and welded blades and with semirecessed mullions at corners.
- F. Provide subsills made of same material as louvers for recessed louvers.
- G. Join frame members to each other and to fixed louver blades with fillet welds concealed from view, unless otherwise indicated or size of louver assembly makes bolted connections between frame members necessary.

2.8 ALUMINUM FINISHES

- A. **Clear Anodic Finish:** AAMA 611, AA-M12C22A41, Class I, 0.018 mm or thicker.

PART 3 - EXECUTION

3.1 EXAMINATION

- A. Examine substrates and openings, with Installer present, for compliance with requirements for installation tolerances and other conditions affecting performance of the Work.
- B. Proceed with installation only after unsatisfactory conditions have been corrected.

3.2 PREPARATION

- A. Coordinate setting drawings, diagrams, templates, instructions, and directions for installation of anchorages that are to be embedded in concrete or masonry construction. Coordinate delivery of such items to Project site.

3.3 INSTALLATION

- A. Locate and place louvers level, plumb, and at indicated alignment with adjacent work.
- B. Use concealed anchorages where possible. Provide brass or lead washers fitted to screws where required to protect metal surfaces and to make a weather-tight connection.
- C. Form closely fitted joints with exposed connections accurately located and secured.
- D. Provide perimeter reveals and openings of uniform width for sealants and joint fillers, as indicated.
- E. Protect unpainted galvanized and nonferrous-metal surfaces that are in contact with concrete, masonry, or dissimilar metals from corrosion and galvanic action by applying a heavy coating of bituminous paint or by separating surfaces with waterproof gaskets or nonmetallic flashing.
- F. Install concealed gaskets, flashings, joint fillers, and insulation as louver installation progresses, where weather-tight louver joints are required. Comply with Section 241080 "Joint Sealants" for sealants applied during louver installation.

3.4 ADJUSTING AND CLEANING

- A. Clean exposed louver surfaces that are not protected by temporary covering, to remove fingerprints and soil during construction period. Do not let soil accumulate during construction period.
- B. Before final inspection, clean exposed surfaces with water and a mild soap or detergent not harmful to finishes. Thoroughly rinse surfaces and dry.
- C. Restore louvers damaged during installation and construction so no evidence remains of corrective work. If results of restoration are unsuccessful, as determined by Owner, remove damaged units and replace with new units.
 - 1. Touch up minor abrasions in finishes with air-dried coating that matches color and gloss of, and is compatible with, factory-applied finish coating.

** END OF SECTION **

**SECTION 241030
NON-STRUCTURAL METAL FRAMING**

PART 1 - GENERAL

1.1 SUMMARY

A. Section Includes:

1. Non-load-bearing steel framing systems for interior gypsum board and plywood assemblies.

1.2 ACTION SUBMITTALS

- A. Product Data:** For each type of product.

1.3 INFORMATION SUBMITTALS

- A. Evaluation Reports:** For steel studs and runners from ICC-ES.

PART 2 - PRODUCTS

2.1 FRAMING SYSTEMS

- A. Framing Members, General:** Comply with ASTM C 754 for conditions indicated.

1. Steel Sheet Components: Comply with ASTM C 645 requirements for metal unless otherwise indicated.

- B. Studs and Runners:** ASTM C 645.

1. Steel Studs and Runners:

- a. Minimum Base-Metal Thickness: 0.033 inch.
- b. Depth: 3-5/8 inches.

- C. Slip Type Head Joints: Provide the following:
1. Deflection Track: Steel sheet top runner manufactured to prevent cracking of finishes applied to interior partition framing resulting from deflection of structure above; in thickness not less than indicated for studs and in width to accommodate depth of studs.
 - a. Products: Subject to compliance with requirements, available products that may be incorporated into the Work include, but are not limited to, the following:
 - 1) Dietrich Metal Framing; SLP-TRK Slotted Deflection Track.
 - 2) MBA Building Supplies; FlatSteel Deflection Track or Slotted Deflecto Track.
 - 3) Steel Network Inc. (The); VertiClip SLD or VertiTrack VTD Series.
 - 4) Superior Metal Trim; Superior Flex Track System (SFT).
 - 5) Telling Industries; Vertical Slip Track or Vertical Slip Track II.
- D. Flat Strap and Backing Plate: Steel sheet for blocking and bracing in length and width indicated.
1. Minimum Base-Metal Thickness: 0.033 inch.
- E. Cold Rolled Channel Bridging: Steel, 0.053-inch minimum base metal thickness, with minimum 1/2-inch wide flanges.
1. Depth: 1-1/2 inches.
 2. Clip Angle: Not less than 1-1/2 by 1-1/2 inches, 0.068-inch thick, galvanized steel.
- F. Hat-Shaped, Rigid Furring Channels: ASTM C 645.
1. Minimum Base-Metal Thickness: 0.033 inch.
 2. Depth: As indicated on Drawings.
- G. Resilient Furring Channels: 1/2-inch deep, steel sheet members designed to reduce sound transmission.
1. Configuration: Asymmetrical or hat shaped. Install with open leg up.
- H. Cold-Rolled Furring Channels: 0.053-inch uncoated-steel thickness, with minimum 1/2-inch wide flanges.
1. Depth: As indicated on Drawings.
 2. Furring Brackets: Adjustable, corrugated-edge type of steel sheet with minimum uncoated-steel thickness of 0.033 inch.
 3. Tie Wire: ASTM A 641, Class 1 zinc coating, soft temper, 0.062-inch diameter wire, or double strand of 0.048-inch diameter wire.

2.2 SUSPENSION SYSTEMS

- A. Tie Wire: ASTM A 641, Class 1 zinc coating, soft temper, 0.062-inch diameter wire, or double strand of 0.048 inch diameter wire.
- B. Hanger Attachments to Concrete:

1. Anchors: Fabricated from corrosion-resistant materials with holes or loops for attaching wire hangers and capable of sustaining, without failure, a load equal to 5 times that imposed by construction as determined by testing according to ASTM E 488 by an independent testing agency.
 - a. Type: Post-installed, expansion anchor.
 2. Powder Actuated Fasteners: Suitable for application indicated, fabricated from corrosion-resistant materials with clips or other devices for attaching hangers of type indicated, and capable of sustaining, without failure, a load equal to 10 times that imposed by construction as determined by testing according to ASTM E 1190 by an independent testing agency.
- C. Wire Hangers: ASTM A 641, Class 1 zinc coating, soft temper, 0.16 inch in diameter.
- D. Flat Hangers: Steel sheet, 1 by 3/16 inch by length required.
- E. Carrying Channels: Cold-rolled, commercial-steel sheet with a base-metal thickness of 0.053 inch and minimum 1/2-inch wide flanges.
1. Depth: 2-1/2 inches.
- F. Furring Channels (Furring Members):
1. Cold-Rolled Channels: 0.053-inch uncoated-steel thickness, with minimum 1/2-inch wide flanges, 3/4 inch deep.
 2. Steel Studs and Runners: ASTM C 645.
 - a. Minimum Base-Metal Thickness: 0.033 inch.
 - b. Depth: 3-5/8 inches.
 3. Hat-Shaped, Rigid Furring Channels: ASTM C 645, 7/8 inch deep.
 - a. Minimum Base-Metal Thickness: 0.033 inch.
 4. Resilient Furring Channels: 1/2-inch deep members designed to reduce sound transmission.
 - a. Configuration: Asymmetrical or hat shaped.

2.3 AUXILIARY MATERIALS

- A. General: Provide auxiliary materials that comply with referenced installation standards.
1. Fasteners for Metal Framing: Of type, material, size, corrosion resistance, holding power, and other properties required to fasten steel members to substrates.
- B. Isolation Strip at Exterior Walls: Provide one of the following:
1. Asphalt-Saturated Organic Felt: ASTM D 226, Type I (No. 15 asphalt felt), non-perforated.

2. Foam Gasket: Adhesive backed, closed cell vinyl foam strips that allow fastener penetration without foam displacement, 1/8 inch thick, in width to suit steel stud size.

PART 3 - EXECUTION

3.1 EXAMINATION

- A. Examine areas and substrates, with Installer present, and including welded hollow metal frames, cast-in anchors, and structural framing, for compliance with requirements and other conditions affecting performance of the Work.
- B. Proceed with installation only after unsatisfactory conditions have been corrected.

3.2 PREPARATION

- A. Suspended Assemblies: Coordinate installation of suspension systems with installation of overhead structure to ensure that inserts and other provisions for anchorages to building structure have been installed to receive hangers at spacing required to support the Work and that hangers will develop their full strength.
 1. Furnish concrete inserts and other devices indicated to other trades for installation in advance of time needed for coordination and construction.
- B. Coordination with Intumescent Fire-Resistive Materials:
 1. Before intumescent fire-resistive materials are applied, attach offset anchor plates or ceiling runners (tracks) to surfaces indicated to receive intumescent fire-resistive materials. Where offset anchor plates are required, provide continuous plates fastened to building structure not more than 24 inches o.c.
 2. Do not reduce thickness of intumescent fire-resistive materials that required for fire-resistance ratings indicated. Protect adjacent fire-resistive materials from damage.

3.3 INSTALLATION, GENERAL

- A. Installation Standard: ASTM C 754, except comply with framing sizes and spacing indicated.
 1. Gypsum Board Assemblies: Also comply with requirements in ASTM C 840 that apply to framing installation.
- B. Install supplementary framing, and blocking to support fixtures, equipment, furnishings, or similar construction.
- C. Install bracing at terminations in assemblies.
- D. Do not bridge building control and expansion joints with non-load-bearing steel framing members. Frame both sides of joints independently.

3.4 INSTALLING FRAMED ASSEMBLIES

- A. Where studs are installed directly against exterior masonry walls or dissimilar metals at exterior walls, install isolation strip between studs and exterior wall.
- B. Install studs so flanges within framing system point in same direction.
 - 1. Space studs as follows:
 - a. Single-Layer Application: 16 inches o.c. unless otherwise indicated.
- C. Install tracks (runners) at floors and overhead supports. Extend framing full height to structural supports. Continue framing around ducts penetrating partitions above ceiling.
 - 1. Slip-Type Head Joints: Where framing extends to overhead structural supports, install to produce joints at tops of framing systems that prevent axial loading of finished assemblies.
- D. Direct Furring:
 - 1. Screw to framing.
 - 2. Attach to concrete or masonry with stub nails, screws designed for masonry attachment, or powder-driven fasteners spaced 24 inches o.c.
- E. Installation Tolerance: Install each framing member so fastening surfaces vary not more than 1/8 inch from the plane formed by faces of adjacent framing.

** END OF SECTION **

SECTION 241040 GYPSUM BOARD

PART 1 - GENERAL

1.1 SUMMARY

A. Section Includes:

1. Interior gypsum board.

B. Related Requirements:

1. Section 241030 "Non-Structural Metal Framing" for non-structural framing that supports gypsum board panels.

1.2 ACTION SUBMITTALS

A. Product Data: For each type of product.

B. Samples: For the following products:

1. Trim Accessories: Full-size Sample in 12-inch long length for each trim accessory indicated.

1.3 DELIVERY, STORAGE AND HANDLING

- A.** Store materials inside under cover and keep them dry and protected against weather, condensation, direct sunlight, construction traffic, and other potential causes of damage. Stack panels flat and supported on risers on a flat platform to prevent sagging.

1.4 FIELD CONDITIONS

- A.** Environmental Limitations: Comply with ASTM C 840 requirements or gypsum board Manufacturer's written recommendations, whichever are more stringent.

- B.** Do not install paper faced gypsum panels until installation areas are enclosed and conditioned.

- C.** Do not install panels that are wet, those that are moisture damaged, and those that are mold damaged.

1. Indications that panels are wet or moisture damaged include, but are not limited to, discoloration, sagging, or irregular shape.
2. Indications that panels are mold damaged include, but are not limited to, fuzzy or splotchy surface contamination and discoloration.

PART 2 - PRODUCTS

2.1 GYPSUM BOARD, GENERAL

- A. Size: Provide maximum lengths and widths available that will minimize joints in each area and that correspond with support system indicated.

2.2 INTERIOR GYPSUM BOARD

- A. Manufacturers: Subject to compliance with requirements, available Manufacturers offering products that may be incorporated into the Work include, but are not limited to, the following:
 - 1. American Gypsum.
 - 2. CertainTeed Corp.
 - 3. Georgia-Pacific Gypsum LLC.
 - 4. Lafarge North America Inc.
 - 5. National Gypsum Company.
 - 6. PABCO Gypsum.
 - 7. Temple-Inland.
 - 8. USG Corporation.
- B. Abuse Resistant Gypsum Board: ASTM C 1629. Manufactured to product greater resistance to surface indentation through penetration (impact resistance), and abrasion than standard, regular type and Type X gypsum board.
 - 1. Core: 5/8 inch, Type X.
 - 2. Long Edges: Tapered.
 - 3. Mold Resistance: ASTM D 3273, score of 10.
 - 4. Install in all areas where gypsum board is specified.

2.3 TRIM ACCESSORIES

- A. Interior Trim: ASTM C 1047.
 - 1. Material: Galvanized or aluminum coated steel sheet or rolled zinc.
 - 2. Shapes:
 - a. Cornerbead.
 - b. Expansion (control) joint.

2.4 JOINT TREATMENT MATERIALS

- A. General: Comply with ASTM C 475.
- B. Joint Tape:
 - 1. Interior Gypsum Board: Paper.

- C. Joint Compound for Interior Gypsum Board: For each coat use formulation that is compatible with other compounds applied on previous or for successive coats.
 - 1. Pre-filling: At open joints and damaged surface areas, use setting-type taping compound.
 - 2. Embedding and First Coat: For embedding tape and first coat on joints, fasteners, and trim flanges, use drying-type, all-purpose compound.
 - a. Use setting-type compound for installing paper-faced metal trim accessories.
 - 3. Fill Coat: For second coat, use drying-type, all-purpose compound.
 - 4. Finish Coat: For third coat, use drying-type, all-purpose compound.

2.5 AUXILIARY MATERIALS

- A. General: Provide auxiliary materials that comply with referenced installation standards and Manufacturer's written recommendations.
- B. Steel Drill Screws: ASTM C 1002, unless otherwise indicated.
 - 1. Use screws complying with ASTM C 954 for fastening panels to steel members from 0.033 to 0.112 inch thick.
- C. Acoustical Joint Sealant: Manufacturer's standard non-sag, paintable, non-staining latex sealant complying with ASTM C 834. Product effectively reduces airborne sound transmission through perimeter joints and openings in building construction as demonstrated by testing representative assemblies according to ASTM E 90.
 - 1. Products: Subject to compliance with requirements, available products that may be incorporated into the Work include, but are not limited to, the following:
 - a. Accumetric LLC; BOSS 824 Acoustical Sound Sealant.
 - b. Grabber Construction Products; Acoustical Sealant GSC.
 - c. Pecora Corporation; AC-20 FTR or AIS-919.
 - d. Specified Technologies, Inc.; Smoke N Sound Acoustical Sealant.
 - e. USG Corporation; SHEETROCK Acoustical Sealant.

PART 3 - EXECUTION

3.1 EXAMINATION

- A. Examine areas and substrates with Installer present, for compliance with requirements and other conditions affecting performance.
- B. Examine panels before installation. Reject panels that are wet, moisture damaged, and mold damaged.
- C. Proceed with installation only after unsatisfactory conditions have been corrected.

3.2 APPLYING AND FINISHING PANELS, GENERAL

- A. Comply with ASTM C 840.
- B. Install panels with face side out. Butt panels together for a light contact at edges and ends with not more than 1/16 inch of open space between panels. Do not force into place.
- C. Locate edge and end joints over supports, except in ceiling applications where intermediate supports or gypsum board back-blocking is provided behind end joints. Do not place tapered edges against cut edges or ends. Stagger vertical joints on opposite sides of partitions. Do not make joints other than control joints at corners of framed openings.
- D. Form control and expansion joints with space between edges of adjoining gypsum panels.
- E. Cover both faces of support framing with gypsum panels in concealed spaces.
 - 1. Fit gypsum panels around ducts, pipes, and conduits.
 - 2. Where partitions intersect structural members projecting below underside of floor/roof slabs and decks, cut gypsum panels to fit profile formed by structural members; allow 1/4- to 3/8-inch wide joints to install sealant.
- F. Isolate perimeter of gypsum board applied to non-load-bearing partitions at structural abutments, except floors. Provide 1/4- to 1/2-inch wide spaces at these locations and trim edges with edge trim where edges of panels are exposed. Seal joints between edges and abutting structural surfaces with acoustical sealant.
- G. Attachment to Steel Framing: Attach panels so leading edge or end of each panel is attached to open (unsupported) edges of stud flanges first.

3.3 APPLYING INTERIOR GYPSUM BOARD

- A. Install interior gypsum board in the following locations:
 - 1. Abuse-Resistant Type: All areas.

B. Single Layer Application:

1. On partitions, apply gypsum panels horizontally and minimize end joints.
 - a. Stagger abutting end joints not less than one framing member in alternate courses of panels.
2. Fastening Methods: Apply gypsum panels to supports with steel drill screws.

3.4 INSTALLING TRIM ACCESSORIES

- A. General: For trim with back flanges intended for fasteners, attach to framing with same fasteners used for panels. Otherwise, attach trim according to Manufacturer's written instructions.
- B. Control Joints: Install control joints according to ASTM C 840 and in specific locations approved by Owner for visual effect.
- C. Interior Trim: Install in the following locations:
 1. Cornerbead: Use at outside corners unless otherwise indicated.

3.5 FINISHING GYPSUM BOARD

- A. General: Treat gypsum board joints, control joints, penetrations, fastener heads, surface defects, and elsewhere as required to prepare gypsum board surfaces for finish. Promptly remove residual joint compound from adjacent surfaces.
- B. Pre-fill open joints and damaged surface areas.
- C. Apply joint tape over gypsum board joints, except for trim products specifically indicated as not intended to receive tape.
- D. Gypsum Board Finish Levels: Finish panels to levels indicated below and according to ASTM C 840:
 1. Level 1: Concealed areas.
 2. Level 4: All exposed panel surface.

3.6 PROTECTION

- A. Protect adjacent surfaces from drywall compound and promptly remove from floors and other non-drywall surfaces. Repair surfaces stained, marred, or otherwise damaged during drywall application.
- B. Protect installed products from damage from weather, condensation, direct sunlight, construction, and other causes during remainder of the construction period.
- C. Remove and replace panels that are wet, moisture damaged, and mold damaged.

1. Indications that panels are wet or moisture damaged include, but are not limited to, discoloration, sagging, or irregular shape.
2. Indications that panels are mold damaged include, but are not limited to, fuzzy or splotchy surface contamination and discoloration.

** END OF SECTION **

SECTION 241050 INTUMESCENT FIREPROOFING

PART 1 - GENERAL

1.1 SUMMARY

- A. Section includes mastic and intumescent fire-resistive coatings (MIFRC).

1.2 PREINSTALLATION MEETINGS

- A. Pre-installation Conference: Conduct conference at Project site.
 - 1. Review products, design ratings, unrestrained conditions, thicknesses, and other performance requirements.

1.3 ACTION SUBMITTALS

- A. Product Data: For each type of product.
- B. Shop Drawings: Structural framing plans indicating the following:
 - 1. Extent of fireproofing for each construction and fire-resistance rating.
 - 2. Applicable fire-resistance design designations of a qualified testing and inspecting agency acceptable to authorities having jurisdiction.
 - 3. Minimum fireproofing thicknesses needed to achieve required fire-resistance rating of each structural component and assembly.
 - 4. Treatment of fireproofing after application.
- C. Samples: For each exposed product and for each color and texture specified, **4 inches** square in size.

1.4 INFORMATIONAL SUBMITTALS

- A. Qualification Data: For Installer and testing agency.
- B. Product Certificates: For each type of fireproofing.
- C. Evaluation Reports: For fireproofing, from ICC-ES.
- D. Field quality-control reports.

1.5 QUALITY ASSURANCE

- A. Installer Qualifications: A firm or individual certified, licensed, or otherwise qualified by fireproofing manufacturer as experienced and with sufficient trained staff to install manufacturer's products according to specified requirements.
- B. Mockups: Build mockups to verify selections made under Sample submittals and to demonstrate aesthetic effects and to set quality standards for materials and execution.
 - 1. Build mockup of each type of fireproofing and different substrate and each required finish as shown on Drawings.
 - 2. Subject to compliance with requirements, approved mockups may become part of the completed Work if undisturbed at time of Substantial Completion.

1.6 FIELD CONDITIONS

- A. Environmental Limitations: Do not apply fireproofing when ambient or substrate temperature is **50 deg F** or lower unless temporary protection and heat are provided to maintain temperature at or above this level for 24 hours before, during, and for 24 hours after product application.
- B. Ventilation: Ventilate building spaces during and after application of fireproofing, providing complete air exchanges according to manufacturer's written instructions. Use natural means or, if they are inadequate, forced-air circulation until fireproofing dries thoroughly.

PART 2 - PRODUCTS

2.1 MATERIALS, GENERAL

- A. Assemblies: Provide fireproofing, including auxiliary materials, according to requirements of each fire-resistance design and manufacturer's written instructions.
- B. Source Limitations: Obtain fireproofing for each fire-resistance design from single source.
- C. Fire-Resistance Design: Tested according to ASTM E 119 by a qualified testing agency. Identify products with appropriate markings of applicable testing agency.
 - 1. Steel members are to be considered unrestrained unless specifically noted otherwise.
- D. VOC Content: Products shall comply with VOC content limits of authorities having jurisdiction and the following VOC limits when calculated according to 40 CFR 59, Subpart D (EPA Method 24):
 - 1. Flat Paints and Coatings: 50 g/L.
 - 2. Nonflat Paints and Coatings: 150 g/L.
 - 3. Primers, Sealers, and Undercoaters: 200 g/L.
 - 4. Anticorrosive and Antirust Paints Applied to Ferrous Metals: 250 g/L.
 - 5. Fireproofing Exterior Coatings: 350 g/L.
- E. Asbestos: Provide products containing no detectable asbestos.

2.2 MASTIC AND INTUMESCENT FIRE-RESISTIVE COATINGS

- A. MIFRC: Manufacturer's standard, factory-mixed formulation or factory-mixed, multicomponent system consisting of intumescent base coat and topcoat, and complying with indicated fire-resistance design.
1. Products: Subject to compliance with requirements, available products that may be incorporated into the Work include, but are not limited to, the following:
 - a. Albi Manufacturing, Division of StanChem Inc.; Albi Clad 800 and Albi Clad TF.
 - b. Carboline Company, subsidiary of RPM International, Fireproofing Products Div.; AD Firefilm III.
 - c. Isolatek International; Cafco SprayFilm-WB 3 and Cafco SprayFilm-WB 4. **Basis-of-Design** product.
 2. Application: Designated for "interior general purpose" and "conditioned interior space purpose" use by a qualified testing agency acceptable to authorities having jurisdiction.
 3. Thickness: As required for fire-resistance design indicated, measured according to requirements of fire-resistance design.
 4. Surface-Burning Characteristics: Comply with ASTM E 84; testing by a qualified testing agency. Identify products with appropriate markings of applicable testing agency.
 - a. Flame-Spread Index: 25 or less.
 - b. Smoke-Developed Index: 450 or less.
 5. Hardness: Not less than 80, Type D durometer, according to ASTM D 2240.
 6. Finish: As selected by Owner from manufacturer's standard finishes.
 - a. Color and Gloss: As **selected by Owner** from manufacturer's full range.
 7. Assembly: **Unrestrained**

2.3 AUXILIARY MATERIALS

- A. General: Provide auxiliary materials that are compatible with fireproofing and substrates and are approved by UL or another testing and inspecting agency acceptable to authorities having jurisdiction for use in fire-resistance designs indicated.
- B. Substrate Primers: Primers approved by fireproofing manufacturer and complying with required fire-resistance design by UL or another testing and inspecting agency acceptable to authorities having jurisdiction. Field Apply **Isolatek Cafco Spray Film approved primer** (or Intumescent Fireproofing approved primer) over zinc rich primer that is applied to raw steel when fabricated prior to applying Intumescent Coating.
- C. Reinforcing Fabric: Glass- or carbon-fiber fabric of type, weight, and form required to comply with fire-resistance designs indicated; approved and provided by fireproofing manufacturer.
- D. Reinforcing Mesh: Metallic mesh reinforcement of type, weight, and form required to comply with fire-resistance design indicated; approved and provided by fireproofing manufacturer. Include pins and attachment.

- E. Topcoat: Suitable for application over applied fireproofing; of type recommended in writing by fireproofing manufacturer for each fire-resistance design.

PART 3 - EXECUTION

3.1 EXAMINATION

- A. Examine substrates, areas, and conditions, with Installer present, for compliance with requirements for substrates and other conditions affecting performance of the Work and according to each fire-resistance design. Verify compliance with the following:
 - 1. Substrates are free of dirt, oil, grease, release agents, rolling compounds, mill scale, loose scale, incompatible primers, paints, and encapsulants, or other foreign substances capable of impairing bond of fireproofing with substrates under conditions of normal use or fire exposure.
 - 2. Objects penetrating fireproofing, including clips, hangers, support sleeves, and similar items, are securely attached to substrates.
 - 3. Substrates receiving fireproofing are not obstructed by ducts, piping, equipment, or other suspended construction that will interfere with fireproofing application.
- B. Conduct tests according to fireproofing manufacturer's written recommendations to verify that substrates are free of substances capable of interfering with bond.
- C. Prepare written report, endorsed by Installer, listing conditions detrimental to performance of the Work.
- D. Proceed with installation only after unsatisfactory conditions have been corrected.

3.2 PREPARATION

- A. Cover other work subject to damage from fallout or overspray of fireproofing materials during application, including galvanized metal decking. Clean all materials affected by overspray of intumescent fireproofing not properly protected.
- B. Clean substrates of substances that could impair bond of fireproofing.
- C. Prime substrates where included in fire-resistance design and where recommended in writing by fireproofing manufacturer unless compatible shop primer has been applied and is in satisfactory condition to receive fireproofing.
- D. For applications visible on completion of Project, repair substrates to remove surface imperfections that could affect uniformity of texture and thickness in finished surface of fireproofing. Remove minor projections and fill voids that would telegraph through fire-resistive products after application.

3.3 APPLICATION

- A. Construct fireproofing assemblies that are identical to fire-resistance design indicated and products as specified, tested, and substantiated by test reports; for thickness, primers, topcoats, finishing, and other materials and procedures affecting fireproofing work.
- B. Comply with fireproofing manufacturer's written instructions for mixing materials, application procedures, and types of equipment used to mix, convey, and apply fireproofing; as applicable to particular conditions of installation and as required to achieve fire-resistance ratings indicated.
- C. Coordinate application of fireproofing with other construction to minimize need to cut or remove fireproofing.
 - 1. Do not begin applying fireproofing until clips, hangers, supports, sleeves, and other items penetrating fireproofing are in place.
 - 2. Defer installing ducts, piping, and other items that would interfere with applying fireproofing until application of fireproofing is completed.
- D. Install auxiliary materials as required, as detailed, and according to fire-resistance design and fireproofing manufacturer's written recommendations for conditions of exposure and intended use. For auxiliary materials, use attachment and anchorage devices of type recommended in writing by fireproofing manufacturer.
- E. Spray apply fireproofing to maximum extent possible. Following the spraying operation in each area, complete the coverage by trowel application or other placement method recommended in writing by fireproofing manufacturer.
- F. Protect adjacent surfaces from overspray or application of Intumescent Fireproofing and Fireproofing Manufacturer's approved Primer.
- G. Only apply Intumescent Fireproofing Manufacturer's approved primer. Approved primer must be compatible with application over steel fabricators zinc rich primer applied during fabrication.
- H. Extend fireproofing in full thickness over entire area of each substrate to be protected.
- I. Install body of fireproofing in a single course unless otherwise recommended in writing by fireproofing manufacturer.
- J. Provide a uniform finish complying with description indicated for each type of fireproofing material and matching finish approved for required mockups.
- K. Cure fireproofing according to fireproofing manufacturer's written recommendations.
- L. Do not install enclosing or concealing construction until after fireproofing has been applied, inspected, and tested and corrections have been made to deficient applications.
- M. Finishes: Where indicated, apply fireproofing to produce the following finishes:
 - 1. Manufacturer's Standard Finishes: Finish according to manufacturer's written instructions for each finish selected.

N. Assembly: **Unrestrained**.

3.4 FIELD QUALITY CONTROL

- A. Special Inspections: **Owner will engage** a qualified special inspector to perform the following special inspections:
1. Test and inspect as required by the IBC, 1704.11.
- B. Perform the tests and inspections of completed Work in successive stages. Do not proceed with application of fireproofing for the next area until test results for previously completed applications of fireproofing show compliance with requirements. Tested values must equal or exceed values as specified and as indicated and required for approved fire-resistance design.
- C. Fireproofing will be considered defective if it does not pass tests and inspections.
1. Remove and replace fireproofing that does not pass tests and inspections, and retest.
 2. Apply additional fireproofing, per manufacturer's written instructions, where test results indicate insufficient thickness, and retest.
- D. Prepare test and inspection reports.

3.5 CLEANING, PROTECTING, AND REPAIRING

- A. Cleaning: Immediately after completing spraying operations in each containable area of Project, remove material overspray and fallout from surfaces of other construction and clean exposed surfaces to remove evidence of soiling.
- B. Protect fireproofing, according to advice of manufacturer and Installer, from damage resulting from construction operations or other causes, so fireproofing will be without damage or deterioration at time of Substantial Completion.
- C. As installation of other construction proceeds, inspect fireproofing and repair damaged areas and fireproofing removed due to work of other trades.
- D. Repair fireproofing damaged by other work before concealing it with other construction.
- E. Repair fireproofing by reapplying it using same method as original installation or using manufacturer's recommended trowel-applied product.

****END OF SECTION****

SECTION 241060 PENETRATION FIRESTOPPING

PART 1 - GENERAL

1.1 SUMMARY

- A. This Section includes through-penetration firestop systems for penetrations through fire-resistance-rated constructions, including both empty openings and openings containing penetrating items.

1.2 PERFORMANCE REQUIREMENTS

- A. General: For penetrations through the following fire-resistance-rated constructions, including both empty openings and openings containing penetrating items, provide through-penetration firestop systems that are produced and installed to resist spread of fire according to requirements indicated, resist passage of smoke and other gases, and maintain original fire-resistance rating of construction penetrated.
 - 1. Fire-resistance-rated walls including fire walls, fire partitions, fire barriers, and smoke barriers.
 - 2. Fire-resistance-rated horizontal assemblies including floors, floor/ceiling assemblies, and ceiling membranes of roof/ceiling assemblies.
- B. Rated Systems: Provide through-penetration firestop systems with the following ratings determined per ASTM E 814 or UL 1479:
 - 1. F-Rated Systems: Provide through-penetration firestop systems with F-ratings indicated, but not less than that equaling or exceeding fire-resistance rating of constructions penetrated.
 - 2. T-Rated Systems: For the following conditions, provide through-penetration firestop systems with T-ratings indicated, as well as F-ratings, where systems protect penetrating items exposed to potential contact with adjacent materials in occupiable floor areas:
 - a. Penetrations located outside wall cavities.
 - b. Penetrations located outside fire-resistance-rated shaft enclosures.
- C. For through-penetration firestop systems exposed to view, traffic, moisture, and physical damage, provide products that, after curing, do not deteriorate when exposed to these conditions both during and after construction.
 - 1. For piping penetrations for plumbing and wet-pipe sprinkler systems, provide moisture-resistant through-penetration firestop systems.
 - 2. For floor penetrations with annular spaces exceeding 4 inches in width and exposed to possible loading and traffic, provide firestop systems capable of supporting floor loads involved, either by installing floor plates or by other means.
 - 3. For penetrations involving insulated piping, provide through-penetration firestop systems not requiring removal of insulation.

- D. For through penetration firestop systems exposed to view, provide products with flame spread and smoke developed indexes of less than 25 and 450, respectively, as determined per ASTM E 84.

1.3 SUBMITTALS

- A. Product Data: For each type of product indicated.
- B. Shop Drawings: For each through-penetration firestop system, show each type of construction condition penetrated, relationships to adjoining construction, and type of penetrating item. Include firestop design designation of qualified testing and inspecting agency that evidences compliance with requirements for each condition indicated.
 - 1. Submit documentation, including illustrations, from a qualified testing and inspecting agency that is applicable to each through-penetration firestop system configuration for construction and penetrating items.
 - 2. Where Project conditions require modification to a qualified testing and inspecting agency's illustration for a particular through-penetration firestop condition, submit illustration, with modifications marked, approved by through-penetration firestop system Manufacturer's fire-protection engineer as an engineering judgment or equivalent fire-resistance-rated assembly.
- C. Through Penetration Firestop System Schedule: Indicate locations of each through penetration firestop system, along with the following information:
 - 1. Types of penetrating items.
 - 2. Types of constructions penetrated, including fire-resistance ratings and, where applicable, thicknesses of construction penetrated.
 - 3. Through-penetration firestop systems for each location identified by firestop design designation of qualified testing and inspecting agency.
- D. Qualification Data: For Installer.
- E. Product Certificates: For through-penetration firestop system products, signed by product Manufacturer.
- F. Product Test Reports: From a qualified testing agency indicating through penetration firestop system complies with requirements, based on comprehensive testing of current products.

1.4 QUALITY ASSURANCE

- A. Installer Qualifications: A firm that has been approved by FMG according to FMG 4991, "Approval of Firestop Contractors."
- B. Installer Qualifications: A firm experienced in installing through-penetration firestop systems similar in material, design, and extent to that indicated for this Project, whose work has resulted in construction with a record of successful performance. Qualifications include having the necessary experience, staff, and training to install Manufacturer's products per specified requirements. Manufacturer's willingness to sell its through-penetration firestop system

products to Contractor or to Installer engaged by Contractor does not in itself confer qualification on buyer.

- C. Installation Responsibility: Assign installation of through-penetration firestop systems and fire-resistive joint systems in Project to a single qualified installer.
- D. Source Limitations: Obtain through-penetration firestop systems, for each kind of penetration and construction condition indicated, through one source from a single Manufacturer.
- E. Fire Test Response Characteristics: Provide through-penetration firestop systems that comply with the following requirements and those specified in Part 1 "Performance Requirements" Article:
 - 1. Firestopping tests are performed by a qualified testing and inspecting agency. A qualified testing and inspecting agency is UL, or another agency performing testing and follow-up inspection services for firestop systems acceptable to authorities having jurisdiction.
 - 2. Through penetration firestop systems are identical to those tested per testing standard referenced in "Part 1 Performance Requirements" Article. Provide rated systems complying with the following requirements:
 - a. Through penetration firestop system products bear classification marking of qualified testing and inspecting agency.
 - b. Through penetration firestop systems correspond to those indicated by reference to through-penetration firestop system designations listed by the following:
 - 1) UL in its "Fire Resistance Directory."

1.5 DELIVERY, STORAGE, AND HANDLING

- A. Deliver through-penetration firestop system products to Project site in original, unopened containers or packages with intact and legible Manufacturers' labels identifying product and Manufacturer, date of manufacture, lot number, shelf life if applicable, qualified testing and inspecting agency's classification marking applicable to Project, curing time, and mixing instructions for multi-component materials.
- B. Store and handle materials for through-penetration firestop systems to prevent their deterioration or damage due to moisture, temperature changes, contaminants, or other causes.

1.6 PROJECT CONDITIONS

- A. Environmental Limitations: Do not install through-penetration firestop systems when ambient or substrate temperatures are outside limits permitted by through-penetration firestop system Manufacturers or when substrates are wet due to rain, frost, condensation, or other causes.
- B. Ventilate through penetration firestop systems per Manufacturer's written instructions by natural means or, where this is inadequate, forced-air circulation.

1.7 COORDINATION

- A. Coordinate construction of openings and penetrating items to ensure that through-penetration firestop systems are installed according to specified requirements.
- B. Coordinate sizing of sleeves, openings, core drilled holes, or cut openings to accommodate through penetration firestop systems.
- C. Notify Owner's inspecting agency at least seven days in advance of through-penetration firestop system installations; confirm dates and times on days preceding each series of installations.
- D. Do not cover up through-penetration firestop system installations that will become concealed behind other construction until each installation has been examined by Owner's inspecting agency and building inspector, if required by authorities having jurisdiction.

PART 2 - PRODUCTS

2.1 MANUFACTURERS

- A. Available Products: Subject to compliance with requirements, through-penetration firestop systems that may be incorporated into the Work include, but are not limited to, those systems indicated in the Through-Penetration Firestop System Schedule at the end of Part 3 or on Drawings that are produced by one of the following Manufacturers:
 - 1. A/D Fire Protection Systems Inc.
 - 2. Grace, W. R. & Co. - Conn.
 - 3. Hilti, Inc.
 - 4. Johns Manville.
 - 5. Nelson Firestop Products.
 - 6. 3M; Fire Protection Products Division.
 - 7. Tremco; Sealant/Weatherproofing Division (basis-of-design products).
 - 8. USG Corporation.

2.2 FIRESTOPPING, GENERAL

- A. Compatibility: Provide through penetration firestop systems that are compatible with one another; with the substrates forming openings; and with the items, if any, penetrating through penetration firestop systems, under conditions of service and application, as demonstrated by through-penetration firestop system Manufacturer based on testing and field experience.
- B. Accessories: Provide components for each through-penetration firestop system that are needed to install fill materials and to comply with Part 1 "Performance Requirements" Article. Use only components specified by through-penetration firestop system Manufacturer and approved by qualified testing and inspecting agency for firestop systems indicated. Accessories include, but are not limited to, the following items:
 - 1. Permanent forming / damming / backing materials, including the following:
 - a. Slag rock wool fiber insulation.

- b. Sealants used in combination with other forming / damming / backing materials to prevent leakage of fill materials in liquid state.
 - c. Fire rated form board.
 - d. Fillers for sealants.
- 2. Temporary forming materials.
 - 3. Substrate primers.
 - 4. Collars.
 - 5. Steel sleeves.

2.3 FILL MATERIALS

- A. General: Provide through-penetration firestop systems containing the types of fill materials indicated in the Through-Penetration Firestop System Schedule at the end of Part 3 (unless noted otherwise below) by referencing the types of materials described in this Article. Fill materials are those referred to in directories of referenced testing and inspecting agencies as "fill," "void," or "cavity" materials.
- B. Cast-in-Place Firestop Devices: **Tremco Fyre-Can** intumescent device for combustible pipe penetrations in rated floor slab. Factory-assembled devices for use in cast-in-place concrete floors and consisting of an outer metallic sleeve lined with an intumescent strip, a radial extended flange attached to one end of the sleeve for fastening to concrete formwork, and a neoprene gasket. Install in accordance with Manufacturer's installation recommendations.
- C. Acrylic Sealants: **Tremco Tremstop Acrylic** High Performance firestop sealant for metallic pipe, insulated pipe, steel studs, construction joints, and head of wall applications. Install in accordance with Manufacturer's installation recommendations.
- D. Firestop Devices: **TREMstop D** pre-fabricated intumescent collar device for combustible pipe penetrations in rated floor slab. Factory-assembled collars formed from galvanized steel and lined with intumescent material sized to fit specific diameter of penetrant. Install in accordance with Manufacturer's installation recommendations.
- E. Intumescent Wrap Strips: **Tremco Tremstop WS** graphite based intumescent highly flexible laminate wrap strip. Install in accordance with Manufacturer's installation recommendations.
- F. Intumescent Wall Sleeve: **Tremco Fyre-Can Prefabricated Wall Sleeve**, 26 gauge metallic sleeve with fold-in tabs on both ends and a centered stainless steel hose clamp attachment with WS intumescent wrap strip for specific pipe diameter from 1 ½" to 12". Install in accordance with Manufacturer's installation recommendations.
- G. Mortars: **Tremco Tremstop Fire Mortar** Prepackaged dry mixes consisting of a blend of inorganic binders, hydraulic cement, fillers, and lightweight aggregate formulated for mixing with water at Project site to form a non-shrinking, homogeneous mortar. Install in accordance with Manufacturer's installation recommendations.
- H. Pillows / Bags: **Tremco Tremstop PS** re-usable moisture resistant durable heat expanding fiberglass bags filled with intumescent material including a combination of mineral fiber, water insoluble expansion agents, and fire-retardant additives. Install in accordance with Manufacturer's installation recommendations.

- I. **Silicone Sealant: Tremco Fyre-Sil** single component neutral cure high performance elastomeric silicone sealant capable of 25% movement for steel, copper, EMT pipe, fiberglass pipe, jacketed cables, bus ducts, and construction joints. Silicone sealant to be used on concrete or cmu.
 1. Grade: Pourable (self-leveling) formulation for openings in floors and other horizontal surfaces, and non-sag formulation for openings in vertical and other surfaces requiring a non-slumping, gunnable sealant, unless indicated firestop system limits use to non-sag grade for both opening conditions.
 2. Grade for Horizontal Surfaces: Pourable self-leveling formulation for openings in floors and other horizontal surfaces.
 3. Grade for Vertical Surfaces: Gun grade Non-sag formulation for openings in vertical and other surfaces.
 4. Install in accordance with Manufacturer's installation recommendations.

2.4 MIXING

- A. For those products requiring mixing before application, comply with through-penetration firestop system Manufacturer's written instructions for accurate proportioning of materials, water (if required), type of mixing equipment, selection of mixer speeds, mixing containers, mixing time, and other items or procedures needed to produce products of uniform quality with optimum performance characteristics for application indicated.

PART 3 - EXECUTION

3.1 EXAMINATION

- A. Examine substrates and conditions, with Installer present, for compliance with requirements for opening configurations, penetrating items, substrates, and other conditions affecting performance of work.
 1. Proceed with installation only after unsatisfactory conditions have been corrected.

3.2 PREPARATION

- A. **Surface Cleaning:** Clean out openings immediately before installing through-penetration firestop systems to comply with firestop system Manufacturer's written instructions and with the following requirements:
 1. Remove from surfaces of opening substrates and from penetrating items foreign materials that could interfere with adhesion of through-penetration firestop systems.
 2. Clean opening substrates and penetrating items to produce clean, sound surfaces capable of developing optimum bond with through-penetration firestop systems. Remove loose particles remaining from cleaning operation.
 3. Remove laitance and form-release agents from concrete.

- B. Priming: Prime substrates where recommended in writing by through penetration firestop system Manufacturer using that Manufacturer's recommended products and methods. Confine primers to areas of bond; do not allow spillage and migration onto exposed surfaces.
- C. Masking Tape: Use masking tape to prevent through penetration firestop systems from contacting adjoining surfaces that will remain exposed on completion of Work and that would otherwise be permanently stained or damaged by such contact or by cleaning methods used to remove smears from firestop system materials. Remove tape as soon as possible without disturbing firestop system's seal with substrates.

3.3 THROUGH PENETRATION FIRESTOP SYSTEM INSTALLATION

- A. General: Install through penetration firestop systems to comply with Part 1 "Performance Requirements" Article and with firestop system Manufacturer's written installation instructions and published drawings for products and applications indicated.
- B. Install forming / damming / backing materials and other accessories of types required to support fill materials during their application and in the position needed to produce cross-sectional shapes and depths required to achieve fire ratings indicated.
 - 1. After installing fill materials and allowing them to fully cure, remove combustible forming materials and other accessories not indicated as permanent components of firestop systems.
- C. Install fill materials for firestop systems by proven techniques to produce the following results:
 - 1. Fill voids and cavities formed by openings, forming materials, accessories, and penetrating items as required to achieve fire resistance ratings indicated.
 - 2. Apply materials so they contact and adhere to substrates formed by openings and penetrating items.
 - 3. For fill materials that will remain exposed after completing Work, finish to produce smooth, uniform surfaces that are flush with adjoining finishes.

3.4 IDENTIFICATION

- A. Identify through-penetration firestop systems with preprinted metal or plastic labels. Attach labels permanently to surfaces adjacent to and within 6 inches of edge of the firestop systems so that labels will be visible to anyone seeking to remove penetrating items or firestop systems. Use mechanical fasteners for metal labels. For plastic labels, use self-adhering type with adhesives capable of permanently bonding labels to surfaces on which labels are placed and, in combination with label material, will result in partial destruction of label if removal is attempted. Include the following information on labels:
 - 1. The words "Warning Through Penetration Firestop System - Do Not Disturb". Notify Building Management of Any Damage."
 - 2. Contractor's name, address, and phone number.
 - 3. Through penetration firestop system designation of applicable testing / inspecting agency.
 - 4. Date of installation.
 - 5. Through penetration firestop system Manufacturer's name.

6. Installer's name.

3.5 FIELD QUALITY CONTROL

- A. Inspecting Agency: **Owner will engage** a qualified, independent inspecting agency to inspect through penetration firestops. Independent inspecting agency shall comply with ASTM E 2174 requirements including those related to qualifications, conducting inspections, and preparing test reports.
- B. Where deficiencies are found, repair or replace through-penetration firestop systems so they comply with requirements.
- C. Proceed with enclosing through penetration firestop systems with other construction only after inspection reports are issued and firestop installations comply with requirements.

3.6 CLEANING AND PROTECTING

- A. Clean off excess fill materials adjacent to openings as Work progresses by methods and with cleaning materials that are approved in writing by through penetration firestop system Manufacturers and that do not damage materials in which openings occur.
- B. Provide final protection and maintain conditions during and after installation that ensure that through penetration firestop systems are without damage or deterioration at time of Substantial Completion. If, despite such protection, damage or deterioration occurs, cut out and remove damaged or deteriorated through penetration firestop systems immediately and install new materials to produce systems complying with specified requirements.
- C. Through Penetration Firestop System Schedule:

1.	Concrete Floors	Circular Blank Openings	1 HR	FA 0005/CAJ 0055
2.	Concrete Floors	Single Metal Pipes or Conduit	1 HR	FA 1016/CAJ 1226
3.	Concrete Floors	Single or Bundled Cables	1 HR	FA 3007/CAJ 3095
4.	Concrete Floors	Single Insulated Pipes	1 HR	FA 5017/ CAJ 5091
5.	Concrete Floors	Uninsulated Mech Ductwork	1 HR	CAJ 7051/CAJ 7046
6.	Concrete Floors	Mixed Penetrants	1 HR	CAJ 8096/CAJ 8056
7.	Conc or cmu Walls	Circular Blank Openings	1 HR	CAJ 0055
8.	Conc or cmu Walls	Single Metal Pipes or Conduit	1 HR	CAJ 1226/CAJ 1184
9.	Conc or cmu Walls	Single or Bundled Cables	1 HR	WJ 3036/CAJ 3139
10.	Conc or cmu Walls	Single Insulated Pipes	1 HR	WJ 5042/CAJ 5091
11.	Conc or cmu Walls	Uninsulated Mech Ductwork	1 HR	WJ 7021/WJ 7022
12.	Conc or cmu Walls	Mixed Penetrants	1 HR	CAJ 8096/CAJ 8056

** END OF SECTION **

SECTION 241070 PREFORMED JOINT SEALS

PART 1 - GENERAL

1.1 SUMMARY

A. Section Includes:

1. Preformed, foam joint seals.

B. Related Requirements:

1. Section 241080 "Joint Sealants" for liquid sealants applied over preformed seals in dual seal systems.

1.2 ACTION SUBMITTALS

A. Product Data: For each preformed joint seal product.

B. Samples for Verification: For each type and color of preformed joint seal required, provide Samples with joint seals in **1/2-inch**-wide joints formed between two **6-inch**-long strips of material matching the appearance of exposed surfaces adjacent to joint seals.

C. Preformed Joint Seal Schedule: Include the following information:

1. Joint seal location and designation.
2. Joint width and movement capability.
3. Joint seal manufacturer and product name.
4. Joint seal color.

1.3 INFORMATIONAL SUBMITTALS

A. Product Test Reports: For each preformed joint seal for tests performed by manufacturer and witnessed by a qualified testing agency.

B. Warranties: For special warranties.

1.4 QUALITY ASSURANCE

A. Mockups: Install mockups of assemblies specified in other Sections that are indicated to receive preformed joint seals specified in this Section. Use materials and installation methods specified in this Section.

1.5 WARRANTY

- A. Special Warranty: Installer agrees to repair or replace preformed joint seals that do not comply with performance and other requirements specified in this Section within specified warranty period.
 - 1. Warranty Period: Two years from date of Substantial Completion.
- B. Special Manufacturer's Warranty: Manufacturer agrees to furnish preformed joint seals to repair or replace those that do not comply with performance and other requirements specified in this Section within specified warranty period.
 - 1. Warranty Period: Five years from date of Substantial Completion.

PART 2 - PRODUCTS

2.1 PREFORMED, FOAM JOINT SEALS

- A. Preformed, Foam Joint Seals: Manufacturer's standard joint seal manufactured from urethane or EVA (ethylene vinyl acetate) foam with minimum density of **10 lb/cu. ft.** and impregnated with a nondrying, water-repellent agent. Factory produce in precompressed sizes in roll or stick form to fit joint widths based on design criteria indicated, with factory- or field-applied adhesive for bonding to substrates.
 - 1. Products: Subject to compliance with requirements, available products that may be incorporated into the Work include, but are not limited to, the following:
 - a. EMSEAL Joint Systems, Ltd.; **Backerseal**, Typical Building Joints (exterior) and **Emseal Colorseal**, Typical Expansion Joints (exterior) or Emseal 25V.
 - b. LymTal International, Inc.; Iso-Flex Hydroseal.
 - c. MM Systems Corporation; EIF.
 - d. Sandell Manufacturing Co., Inc.; Polyseal.
 - e. Schul International Company, Inc.; Color Econoseal.
 - f. Watson Bowman Acme Corporation; Wabo SeismicWeatherSeal.
 - 2. Joint Seal Color: As **selected by Owner** from full range of industry colors.

2.2 MISCELLANEOUS MATERIALS

- A. Primer: Material recommended by preformed-joint-seal manufacturer for joint substrates indicated.
- B. Cleaners for Nonporous Surfaces: Chemical cleaners acceptable to preformed joint seal manufacturer, free of oily residues or other substances capable of staining or harming joint substrates and adjacent nonporous surfaces, and formulated to promote best adhesion to joint substrates.
- C. Masking Tape: Nonstaining, nonabsorbent material compatible with preformed joint seals and surfaces adjacent to joints.

PART 3 - EXECUTION

3.1 EXAMINATION

- A. Examine joints indicated to receive preformed joint seals, with Installer present, for compliance with requirements for joint configuration, installation tolerances, and other conditions affecting preformed-joint seal performance.
- B. Proceed with installation only after unsatisfactory conditions have been corrected.

3.2 PREPARATION

- A. Surface Cleaning of Joints: Clean out joints immediately before installing preformed joint seals to comply with preformed joint seal manufacturer's written instructions and the following requirements:
 - 1. Remove all foreign material from joint substrates that could interfere with adhesion of preformed joint seal, including dust, paints (except for permanent protective coatings tested and approved for seal adhesion and compatibility by seal manufacturer), old joint sealants, oil, grease, waterproofing, water repellents, water, surface dirt, and frost.
 - 2. Clean porous joint substrate surfaces by brushing, grinding, mechanical abrading, or a combination of these methods to produce a clean, sound substrate capable of developing optimal bond with preformed joint seals. Remove loose particles remaining after cleaning operations above by vacuuming or blowing out joints with oil-free compressed air. Porous joint substrates include the following:
 - a. Concrete.
 - b. Masonry.
 - c. Unglazed surfaces of ceramic tile.
 - d. Exterior insulation and finish systems.
 - 3. Remove laitance and form-release agents from concrete.
 - 4. Clean nonporous joint substrate surfaces with chemical cleaners or other means that do not stain, harm substrates, or leave residues capable of interfering with adhesion of joint seals. Nonporous joint substrates include the following:
 - a. Metal.
 - b. Glass.
 - c. Porcelain enamel.
 - d. Glazed surfaces of ceramic tile.
- B. Joint Priming: Prime joint substrates where recommended by preformed joint seal manufacturer or as indicated by tests or prior experience. Apply primer to comply with joint seal manufacturer's written instructions. Confine primers to areas of joint seal bond; do not allow spillage or migration onto adjoining surfaces.
- C. Masking Tape: Use masking tape where required to prevent contact of adhesive or primer with adjoining surfaces that otherwise would be permanently stained or damaged by such contact or

by cleaning methods required to remove smears. Remove tape immediately after tooling without disturbing joint seal.

3.3 INSTALLATION

- A. General: Comply with preformed joint seal manufacturer's written installation instructions for products and applications indicated unless more stringent requirements apply.
- B. Installation of Preformed, Foam Joint Seals:
 - 1. Install each length of seal immediately after removing protective wrapping.
 - 2. Firmly secure compressed joint seals to joint gap side to obtain full bond using exposed pressure-sensitive adhesive or field-applied adhesive as recommended by manufacturer.
 - 3. Do not pull or stretch material. Produce seal continuity at splices, ends, turns, and intersections of joints.
 - 4. For applications at low ambient temperatures, heat foam joint seal material in compliance with manufacturer's written instructions.
- C. Installation of Precured, Extruded-Silicone Joint Seals:
 - 1. Apply masking tape to each side of joint, outside of area to be covered by seal system.
 - 2. Apply silicone sealant to each side of joint to produce a bead of size complying with preformed silicone seal system manufacturer's written instructions and covering a bonding area of not less than **3/8 inch**. Hold edge of sealant bead **1/4 inch** inside masking tape.
 - 3. Press silicone extrusion into sealant to wet extrusion and substrate. Use a roller to apply consistent pressure and ensure uniform contact with substrate.
 - 4. Complete installation of seal system in horizontal joints before installing in vertical joints. Lap vertical joints over horizontal joints. At ends of joints, cut silicone extrusion with a razor knife.

3.4 PROTECTION

- A. Protect preformed joint seals from damage resulting from construction operations or other causes so seals are without deterioration or damage at time of Substantial Completion. If, despite such protection, damage or deterioration occurs, cut out, remove, and repair damaged or deteriorated seals immediately so installations with repaired areas are indistinguishable from original work.

** END OF SECTION **

SECTION 241080 JOINT SEALANTS

PART 1 - GENERAL

1.1 SUMMARY

A. Section Includes:

1. Primary joint sealant.
2. Secondary joint sealant.
3. Wall expansion joints.
4. Floor expansion joints.
5. Concrete joints.

B. Related Sections:

1. Section 240020 "Cast-in-Place Concrete".
2. Section 241060 "Penetration Firestopping".
3. Section 240080 "Insulated Metal Wall Panels".
4. Section 241010 "Glazing" for glazing sealants.

1.2 PRECONSTRUCTION TESTING

A. Preconstruction Compatibility and Adhesion Testing: Submit to joint sealant Manufacturers, for testing indicated below, samples of materials that will contact or affect joint sealants.

1. Use Manufacturer's standard test method to determine whether priming and other specific joint preparation techniques are required to obtain rapid, optimum adhesion of joint sealants to joint substrates.
2. Submit not fewer than eight pieces of each kind of material, including joint substrates, shims, joint-sealant backings, secondary seals, and miscellaneous materials.
3. Schedule sufficient time for testing and analyzing results to prevent delaying the Work.
4. For materials failing tests, obtain joint-sealant Manufacturer's written instructions for corrective measures including use of specially formulated primers.
5. Testing will not be required if joint-sealant Manufacturers submit joint preparation data that are based on previous testing, not older than 24 months, of sealant products for adhesion to, and compatibility with, joint substrates and other materials matching those submitted.

B. Preconstruction Field Adhesion Testing: Before installing sealants, field test their adhesion to Project joint substrates as follows:

1. Conduct field tests for each application indicated below:
 - a. Each kind of sealant and joint substrate indicated.
2. Notify Architect seven days in advance of dates and times when test joints will be erected.

3. Arrange for tests to take place with joint-sealant Manufacturer's technical representative present.
 - a. Test Method: Test joint sealants according to Method A, Field Applied Sealant Joint Hand Pull Tab, in Appendix X1 in ASTM C 1193 or Method A, Tail Procedure, in ASTM C 1521.
 - 1) For joints with dissimilar substrates, verify adhesion to each substrate separately; extend cut along one side, verifying adhesion to opposite side. Repeat procedure for opposite side.
4. Report whether sealant failed to adhere to joint substrates or tore cohesively. Include data on pull distance used to test each kind of product and joint substrate. For sealants that fail adhesively, retest until satisfactory adhesion is obtained.
5. Evaluation of Preconstruction Field Adhesion Test Results: Sealants not evidencing adhesive failure from testing, in absence of other indications of noncompliance with requirements, will be considered satisfactory. Do not use sealants that fail to adhere to joint substrates during testing.

1.3 SUBMITTALS

- A. Product Data: For each joint-sealant product indicated.
- B. Samples for Initial Selection: Manufacturer's color charts consisting of strips of cured sealants showing the full range of colors available for each product exposed to view.
- C. Joint Sealant Schedule: Include the following information:
 1. Joint sealant application, joint location, and designation.
 2. Joint sealant Manufacturer and product name.
 3. Joint sealant formulation.
 4. Joint sealant color.
- D. Qualification Data: For qualified Installer.
- E. Product Certificates: For each kind of joint sealant and accessory, from Manufacturer.
- F. Sealant, Waterproofing, and Restoration Institute (SWRI) Validation Certificate: For each sealant specified to be validated by SWRI's Sealant Validation Program.
- G. Preconstruction Compatibility and Adhesion Test Reports: From sealant Manufacturer, indicating the following:
 1. Materials forming joint substrates and joint sealant backings have been tested for compatibility and adhesion with joint sealants.
 2. Interpretation of test results and written recommendations for primers and substrate preparation needed for adhesion.

- H. Preconstruction Field Adhesion Test Reports: Indicate which sealants and joint preparation methods resulted in optimum adhesion to joint substrates based on testing specified in "Preconstruction Testing" Article.
- I. Field Adhesion Test Reports: For each sealant application tested.
- J. Warranties: Sample of special warranties.

1.4 QUALITY ASSURANCE

- A. Installer Qualifications: Manufacturer's authorized representative who is trained and approved for installation of units required for this Project.
- B. Source Limitations: Obtain each kind of joint sealant from single source from single Manufacturer.
- C. Mockups: Install sealant in mockups of assemblies specified in other Sections that are indicated to receive joint sealants specified in this Section. Use materials and installation methods specified in this Section.

1.5 PROJECT CONDITIONS

- A. Do not proceed with installation of joint sealants under the following conditions:
 - 1. When ambient and substrate temperature conditions are outside limits permitted by joint sealant Manufacturer or are below 40 deg F.
 - 2. When joint substrates are wet.
 - 3. Where joint widths are less than those allowed by joint sealant Manufacturer for applications indicated.
 - 4. Where contaminants capable of interfering with adhesion have not yet been removed from joint substrates.

1.6 WARRANTY

- A. Special Installer's Warranty: Manufacturer's standard form in which Installer agrees to repair or replace joint sealants that do not comply with performance and other requirements specified in this Section within specified warranty period.
 - 1. Warranty Period: **Two years** from date of Substantial Completion.
- B. Special Manufacturer's Warranty: Manufacturer's standard form in which joint sealant Manufacturer agrees to furnish joint sealants to repair or replace those that do not comply with performance and other requirements specified in this Section within specified warranty period.
 - 1. Warranty Period: **Twenty years** from date of Substantial Completion.
- C. Special warranties specified in this article exclude deterioration or failure of joint sealants from the following:

1. Movement of the structure caused by structural settlement or errors attributable to design or construction resulting in stresses on the sealant exceeding sealant Manufacturer's written specifications for sealant elongation and compression.
2. Disintegration of joint substrates from natural causes exceeding design specifications.
3. Mechanical damage caused by individuals, tools, or other outside agents.
4. Changes in sealant appearance caused by accumulation of dirt or other atmospheric contaminants.

PART 2 - PRODUCTS

2.1 MATERIALS, GENERAL

- A. **Compatibility:** Provide joint sealants, backings, and other related materials that are compatible with one another and with joint substrates under conditions of service and application, as demonstrated by joint sealant Manufacturer, based on testing and field experience.
- B. **VOC Content of Interior Sealants:** Provide sealants and sealant primers for use inside the weatherproofing system that comply with the following limits for VOC content when calculated according to 40 CFR 59, Part 59, Subpart D (EPA Method 24):
 1. Architectural Sealants: 250 g/L.
 2. Sealant Primers for Nonporous Substrates: 250 g/L.
 3. Sealant Primers for Porous Substrates: 775 g/L.
- C. **Liquid Applied Joint Sealants:** Comply with ASTM C 920 and other requirements indicated for each liquid applied joint sealant specified, including those referencing ASTM C 920 classifications for type, grade, class, and uses related to exposure and joint substrates.
- D. **Stain Test-Response Characteristics:** Where sealants are specified to be non-staining to porous substrates, provide products that have undergone testing according to ASTM C 1248 and have not stained porous joint substrates indicated for Project.
- E. **Colors of Exposed Joint Sealants:** As selected by Owner from Manufacturer's full non-standard range to match adjacent materials. Provide actual samples in building joint for Owner inspection and approval matching adjacent material color for all material applications.

2.2 EXTERIOR SILICONE JOINT SEALANTS - **Primary Building Wall Joint 1 1/4" or less**

- A. **Ultra Low Modulus, High Performance, Non-sag, One Part, Moisture Curing Silicone Joint Sealant:** ASTM C 920, Type S, Grade NS, Class 100/50, for Use NT (non traffic), M, G, A, and O, ASTM C-1382.

1. Basis of Design Products:

- a. **Tremco Spectrem 1.**
- b. **Dow Corning 790.**
- c. **Pecora 890 NST.**

- B. Cylindrical Sealant Backer Rod: ASTM C 1330, Type C closed cell material with size and density to control sealant depth and otherwise contribute to producing optimum sealant curing, performance, and adhesion. Install Backer Rod behind all Primary Joint Sealants over Secondary Expanding Joint material at the proper depth (depth to be 1/2 of the joint width) to provide concave Primary Joint configuration allowing for expansion and contraction while permitting the sealant to cure properly and adhere to side wall material. Install Bond Breaker tape between Backer Rod and Primary Sealant to prevent sealant from adhering to backer Rod.
- C. Bond Breaker Tape: Polyethylene tape or other plastic tape recommended by sealant Manufacturer for preventing sealant from adhering to rigid, inflexible joint filler materials or joint surfaces at back of joint. Provide self adhesive tape where applicable

2.3 EXTERIOR JOINT SEALANT BACKING - **Secondary Building Wall Joint 1 1/4" or less**

- A. Install Secondary joint material behind Primary joint material.

- B. Basis of Design Product: **Backerseal** by **EMSEAL Joint Systems Ltd**, 23 Bridle Lane, Suite 3, Westborough, MA 01581-2603, Toll Free: 800-526-8365 or PH: 508-836-0280, FX: 508-836-0281, www.emseal.com. Provide secondary seal Joint Systems in vertical plane walls (above grade). Typical locations include, but are not limited to the following: applications in window perimeters, other façade penetrations such as doors, store fronts, vents, HVAC units etc, wall joints, aluminum framing, control joints, and between dissimilar materials. Seal shall be comprised of water-based, 100% acrylic, impregnated expanding foam sealant with internal laminations of closed cell (EVA) foam. Alternates containing wax or wax compounds shall not be permitted. Material to be supplied in sticks or rolls, pre-compressed to less than joint size at mean temperature for ease of installation. Material will contain pressure sensitive mounting adhesive on one side of the material to aide installation. Secondary seal to be installed recessed from substrate faces and to receive a field applied primary joint sealant not to exceed 1/4-inch, thick. Refer to Section 079100 "Preformed Joint Seals" for additional requirements.

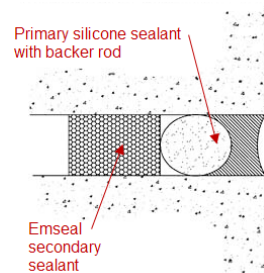

- C. Install in accordance with Manufacturer's installation recommendations and requirements.

2.4 WALL EXPANSION JOINT - **Primary Building Wall Joint 1 1/4" or greater**

- A. Basis of Design Product for Non-Rated Walls: **Colorseal** by **EMSEAL Joint Systems Ltd**, 23 Bridle Lane, Suite 3, Westborough, MA 01581-2603, Toll Free: 800-526-8365 or PH: 508-836-0280, FX: 508-836-0281, www.emseal.com.



- B. Factory applied and cured silicone bellows with a modified acrylic impregnated expanding foam sealant. Provides water-tightness, thermal insulation, 50% movement capability, and requires no mechanical anchors. Provide Manufacturer's pre-formed corners for all wall transitions.

Factory-Fabricated Transitions

COLORSEAL is manufactured in straight-run sticks which can be joined in the field to EMSEAL's patent-pending "Universal-90" transitions.

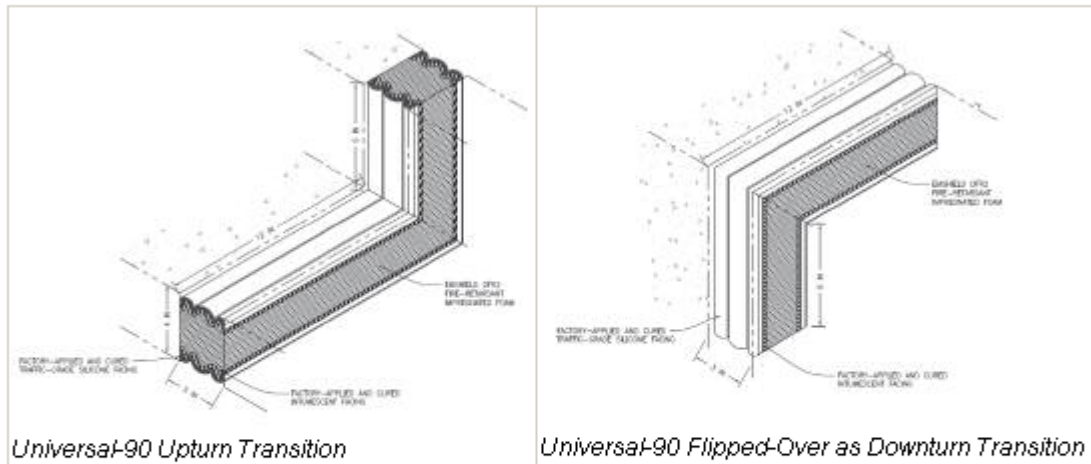

These factory-fabricated single-piece 90-degree units have a 12-inch long leg and a 6-inch vertical piece on each side of the elbow. The Universal-90 transition pieces are symmetrically coated on both faces. This allows them to be installed as an inside corner or as an outside corner.

In addition to guaranteeing watertightness, EMSEAL's "Universal-90's" allow for much faster and secure installation by eliminating field cutting or notching and bending, at angles.

- C. Basis of Design Product for Rated Walls: **WFR2** by **EMSEAL Joint Systems Ltd**, 23 Bridle Lane, Suite 3, Westborough, MA 01581-2603, Toll Free: 800-526-8365 or PH: 508-836-0280, FX: 508-836-0281, www.emseal.com. **WFR2** is a wall joint material with a 2 hour fire rating that is fire retardant impregnated with an intumescent coating.
- D. Install in accordance with Manufacturer's installation instructions and details. Prepare substrates as recommended by the Manufacturer.
- E. Provide Manufacturer's universal 90's to transition from floor to wall as required
- F. Color to be **selected by Owner** from Manufacturer's full range of colors.

2.5 CONCRETE SLAB FLOOR EXPANSION JOINT

- A. Basis of Design Product for Rated Floors: **DFR2 System** by **EMSEAL Joint Systems Ltd**, 23 Bridle Lane, Suite 3, Westborough, MA 01581-2603, Toll Free: 800-526-8365 or PH: 508-836-0280, FX: 508-836-0281, www.emseal.com. Install flush with finished floor surface.

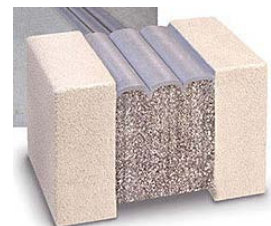

- B. 2 hour fire rated floor joint that is fire retardant impregnated with an intumescent coating.
- C. Install at concrete slabs to allow for traffic over concrete joints. Install in accordance with Manufacturer's installation instructions and details. Prepare substrates as recommended by the Manufacturer.
- D. For non-rated floor applications, Emseal **DSM** expansion joint material can be used.
- E. Provide Manufacturer's universal 90's to transition from floor to wall joint as required.
- F. Color to be **selected by Owner** from Manufacturer's full range of colors.

2.6 JOINT COVERS

- A. Basis of Design Product for Corridor Floor, Walls, and Ceiling installed over Emseal **DFR2** and **WFR2: Construction Specialties, Inc PC-300 Floor Cover** and **PCW-300 Wall Cover** to cover 3" expansion joints. Install covers in alignment for continuous application to cover Emseal joint material.

2.7 CONCRETE HORIZONTAL JOINT FILLER

- A. Non expansion joint applications.
- B. Exterior Joint Basis of design Product; **L&M Construction Chemicals Joint Tite 450** Polyurea in minimum 1" thickness with closed cell backer rod or Versiflex 45.
- C. Interior Joint Basis of design Product; **L&M Construction Chemicals Joint Tite 750** Polyurea in minimum 1" thickness with closed cell backer rod or Versiflex 75.
- D. Install Cylindrical Sealant Backer Rod below joint filler.
- E. ½" **Isolation Joints** at two work bays in Engineering Studio: **Tremco Vulkem 45SSL** one-part semi-self-leveling polyurethane sealant with closed cell or reticulated polyethylene backer rod between stainless steel angles with stainless steel studs at 12" o.c. embedded flush with the concrete floor.

2.8 MISCELLANEOUS MATERIALS

- A. Primer: Material recommended by joint-sealant Manufacturer where required for adhesion of sealant to joint substrates indicated, as determined from preconstruction joint sealant substrate tests and field tests.
- B. Cleaners for Non-porous Surfaces: Chemical cleaners acceptable to Manufacturers of sealants and sealant backing materials, free of oily residues or other substances capable of staining or harming joint substrates and adjacent nonporous surfaces in any way, and formulated to promote optimum adhesion of sealants to joint substrates.
- C. Masking Tape: Non-staining, nonabsorbent material compatible with joint sealants and surfaces adjacent to joints.

PART 3 - EXECUTION

3.1 EXAMINATION

- A. Examine joints indicated to receive joint sealants, with Installer present, for compliance with requirements for joint configuration, installation tolerances, and other conditions affecting joint-sealant performance.
- B. Proceed with installation only after unsatisfactory conditions have been corrected.

3.2 PREPARATION

- A. Surface Cleaning of Joints: Clean out joints immediately before installing joint sealants to comply with joint-sealant Manufacturer's written instructions and the following requirements:
 - 1. Remove all foreign material from joint substrates that could interfere with adhesion of joint sealant, including dust, paints (except for permanent, protective coatings tested and approved for sealant adhesion and compatibility by sealant Manufacturer), old joint sealants, oil, grease, waterproofing, water repellents, water, surface dirt, and frost.
 - 2. Clean porous joint substrate surfaces by brushing, grinding, mechanical abrading, or a combination of these methods to produce a clean, sound substrate capable of developing optimum bond with joint sealants. Remove loose particles remaining after cleaning operations above by vacuuming or blowing out joints with oil free compressed air.
 - 3. Remove laitance and form release agents from concrete.
 - 4. Clean nonporous joint substrate surfaces with chemical cleaners or other means that do not stain, harm substrates, or leave residues capable of interfering with adhesion of joint sealants.
- B. Joint Priming: Prime joint substrates where recommended by joint sealant Manufacturer or as indicated by preconstruction joint sealant substrate tests or prior experience. Apply primer to comply with joint-sealant Manufacturer's written instructions. Confine primers to areas of joint sealant bond; do not allow spillage or migration onto adjoining surfaces.
- C. Masking Tape: Use masking tape where required to prevent contact of sealant or primer with adjoining surfaces that otherwise would be permanently stained or damaged by such contact or by cleaning methods required to remove sealant smears. Remove tape immediately after tooling without disturbing joint seal.

3.3 INSTALLATION OF JOINT SEALANTS

- A. General: Comply with joint sealant Manufacturer's written installation instructions for products and applications indicated, unless more stringent requirements apply.
- B. Sealant Installation Standard: Comply with recommendations in ASTM C 1193 for use of joint sealants as applicable to materials, applications, and conditions indicated.

- C. Install sealant backings of kind indicated to support sealants during application and at position required to produce cross-sectional shapes and depths of installed sealants relative to joint widths that allow optimum sealant movement capability.
 - 1. Do not leave gaps between ends of sealant backings.
 - 2. Do not stretch, twist, puncture, or tear sealant backings.
 - 3. Remove absorbent sealant backings that have become wet before sealant application and replace them with dry materials.
- D. Install bond breaker tape behind sealants where sealant backings are not used between sealants and backs of joints.
- E. Install sealants using proven techniques that comply with the following and at the same time backings are installed:
 - 1. Place sealants so they directly contact and fully wet joint substrates.
 - 2. Completely fill recesses in each joint configuration.
 - 3. Produce uniform, cross-sectional shapes and depths relative to joint widths that allow optimum sealant movement capability.
- F. Tooling of Non-sag Sealants: Immediately after sealant application and before skinning or curing begins, tool sealants according to requirements specified in subparagraphs below to form smooth, uniform beads of configuration indicated; to eliminate air pockets; and to ensure contact and adhesion of sealant with sides of joint.
 - 1. Remove excess sealant from surfaces adjacent to joints.
 - 2. Use tooling agents that are approved in writing by sealant Manufacturer and that do not discolor sealants or adjacent surfaces.
 - 3. Provide concave joint profile per Figure 8A in ASTM C 1193, unless otherwise indicated.
 - 4. Provide flush joint profile where indicated per Figure 8B in ASTM C 1193.
 - 5. Provide recessed joint configuration of recess depth and at locations indicated per Figure 8C in ASTM C 1193.
 - a. Use masking tape to protect surfaces adjacent to recessed tooled joints.

3.4 FIELD QUALITY CONTROL

- A. Field Adhesion Testing: Field test joint sealant adhesion to joint substrates as follows:
 - 1. Extent of Testing: Test completed and cured sealant joints as follows:
 - a. Perform 10 tests for the first 1,000 feet of joint length for each kind of sealant and joint substrate.
 - b. Perform 1 test for each 1,000 feet of joint length thereafter or 1 test per each floor per elevation.
 - 2. Test Method: Test joint sealants according to Method A, Field-Applied Sealant Joint Hand Pull Tab, in Appendix X1 in ASTM C 1193 or Method A, Tail Procedure, in ASTM C 1521.

- a. For joints with dissimilar substrates, verify adhesion to each substrate separately; extend cut along one side, verifying adhesion to opposite side. Repeat procedure for opposite side.
3. Inspect tested joints and report on the following:
 - a. Whether sealants filled joint cavities and are free of voids.
 - b. Whether sealant dimensions and configurations comply with specified requirements.
 - c. Whether sealants in joints connected to pulled-out portion failed to adhere to joint substrates or tore cohesively. Include data on pull distance used to test each kind of product and joint substrate. Compare these results to determine if adhesion passes sealant Manufacturer's field-adhesion hand-pull test criteria.
 4. Record test results in a field adhesion test log. Include dates when sealants were installed, names of persons who installed sealants, test dates, test locations, whether joints were primed, adhesion results and percent elongations, sealant fill, sealant configuration, and sealant dimensions.
 5. Repair sealants pulled from test area by applying new sealants following same procedures used originally to seal joints. Ensure that original sealant surfaces are clean and that new sealant contacts original sealant.
- B. Evaluation of Field Adhesion Test Results: Sealants not evidencing adhesive failure from testing or non-compliance with other indicated requirements will be considered satisfactory. Remove sealants that fail to adhere to joint substrates during testing or to comply with other requirements. Retest failed applications until test results prove sealants comply with indicated requirements.

3.5 CLEANING

- A. Clean off excess sealant or sealant smears adjacent to joints as the Work progresses by methods and with cleaning materials approved in writing by Manufacturers of joint sealants and of products in which joints occur.

3.6 PROTECTION

- A. Protect joint sealants during and after curing period from contact with contaminating substances and from damage resulting from construction operations or other causes so sealants are without deterioration or damage at time of Substantial Completion. If, despite such protection, damage or deterioration occurs, cut out and remove damaged or deteriorated joint sealants immediately so installations with repaired areas are indistinguishable from original work.

** END OF SECTION **

**SECTION 242010
RESILIENT BASE AND ACCESSORIES**

PART 1 - GENERAL

1.1 SUMMARY

- A. Section Includes:
 - 1. Resilient base.

1.2 ACTION SUBMITTALS

- A. Product Data: For each type of product indicated.
- B. Samples for Verification: For each type of product indicated, in Manufacturer's standard size Samples but not less than 12 inches long, of each resilient product color, texture, and pattern required.
- C. Product Schedule: For resilient products.

1.3 MAINTENANCE MATERIAL SUBMITTALS

- A. Furnish extra materials that match products installed and that are packaged with protective covering for storage and identified with labels describing contents.
 - 1. Furnish not less than 10 linear feet for every 500 linear feet or fraction thereof, of each type, color, pattern, and size of resilient product installed.

1.4 QUALITY ASSURANCE

- A. Fire Test Response Characteristics: As determined by testing identical products according to ASTM E 648 or NFPA 253 by a qualified testing agency.
 - 1. Critical Radiant Flux Classification: Class I, not less than 0.45 W/sq. cm.

1.5 DELIVERY, STORAGE, AND HANDLING

- A. Store resilient products and installation materials in dry spaces protected from the weather, with ambient temperatures maintained within range recommended by Manufacturer, but not less than 50 deg F or more than 90 deg F.

1.6 PROJECT CONDITIONS

- A. Maintain ambient temperatures within range recommended by Manufacturer, but not less than 70 deg F or more than 95 deg F, in spaces to receive resilient products during the following time periods:
 - 1. 48 hours before installation.
 - 2. During installation.
 - 3. 48 hours after installation.
- B. Until Substantial Completion, maintain ambient temperatures within range recommended by Manufacturer, but not less than 55 deg F or more than 95 deg F.
- C. Install resilient products after other finishing operations, including painting, have been completed.

PART 2 - PRODUCTS

2.1 RESILIENT BASE

- A. Resilient Base:
 - 1. Manufacturers: Subject to compliance with requirements, available Manufacturers offering products that may be incorporated into the Work include, but are not limited to, the following:
 - a. Armstrong World Industries, Inc.
 - b. Johnsonite.
 - c. Musson, R. C. Rubber Co.
 - d. Roppe Corporation, USA.
- B. Resilient Base Standard: ASTM F 1861.
 - 1. Material: Type TV (vinyl, thermoplastic) or Type TP (rubber, thermoplastic).
 - 2. Manufacturing Method: Group I (solid, homogeneous).
 - 3. Style: Straight (flat or toeless).
- C. Minimum Thickness: 0.080 inch.
- D. Height: 4 inches with straight base.
- E. Lengths: Coils in Manufacturer's standard length.
- F. Outside Corners: Job formed.
- G. Inside Corners: Job formed.
- H. Finish: Matte.
- I. Colors and Patterns: To be **selected by Owner** from Manufacturer's full range of colors.

2.2 INSTALLATION MATERIALS

- A. Trowelable Leveling and Patching Compounds: Latex-modified, Portland cement based or blended hydraulic cement based formulation provided or approved by Manufacturer for applications indicated.
- B. Adhesives: Water-resistant type recommended by Manufacturer to suit resilient products and substrate conditions indicated.
- C. Stair Tread Nose Filler (Alternate A-1): Two-part epoxy compound recommended by resilient tread Manufacturer to fill nosing substrates that do not conform to tread contours.
- D. Metal Edge Strips: Extruded aluminum with mill finish, of height required to protect exposed edges of tiles, and in maximum available lengths to minimize running joints.

PART 3 - EXECUTION

3.1 EXAMINATION

- A. Examine substrates, with Installer present, for compliance with requirements for maximum moisture content and other conditions affecting performance of the Work.
- B. Verify that finishes of substrates comply with tolerances and other requirements specified in other Sections and that substrates are free of cracks, ridges, depressions, scale, and foreign deposits that might interfere with adhesion of resilient products.
- C. Proceed with installation only after unsatisfactory conditions have been corrected.

3.2 PREPARATION

- A. Prepare substrates according to Manufacturer's written instructions to ensure adhesion of resilient products.
- B. Concrete Substrates for Resilient Stair Treads and Accessories (Alternate A-1): Prepare according to ASTM F 710.
 - 1. Verify that substrates are dry and free of curing compounds, sealers, and hardeners.
 - 2. Remove substrate coatings and other substances that are incompatible with adhesives and that contain soap, wax, oil, or silicone, using mechanical methods recommended by Manufacturer. Do not use solvents.
 - 3. Alkalinity and Adhesion Testing: Perform tests recommended by Manufacturer.
 - 4. Moisture Testing: Perform tests recommended by Manufacturer and as follows. Proceed with installation only after substrates pass testing.
 - a. Perform anhydrous calcium chloride test, ASTM F 1869. Proceed with installation only after substrates have maximum moisture-vapor-emission rate of 3 lb of water/1000 sq. ft. in 24 hours.

- b. Perform relative humidity test using in situ probes, ASTM F 2170. Proceed with installation only after substrates have maximum 75 percent relative humidity level measurement.
- C. Fill cracks, holes, and depressions in substrates with trowelable leveling and patching compound and remove bumps and ridges to produce a uniform and smooth substrate.
- D. Do not install resilient products until they are same temperature as the space where they are to be installed.
 - 1. Move resilient products and installation materials into spaces where they will be installed at least 48 hours in advance of installation.
- E. Sweep and vacuum clean substrates to be covered by resilient products immediately before installation.

3.3 RESILIENT BASE INSTALLATION

- A. Comply with Manufacturer's written instructions for installing resilient base.
- B. Apply resilient base to walls, columns, pilasters, casework and cabinets in toe spaces, and other permanent fixtures in rooms and areas where base is required.
- C. Install resilient base in lengths as long as practicable without gaps at seams and with tops of adjacent pieces aligned.
- D. Tightly adhere resilient base to substrate throughout length of each piece, with base in continuous contact with horizontal and vertical substrates.
- E. Do not stretch resilient base during installation.
- F. On masonry surfaces or other similar irregular substrates, fill voids along top edge of resilient base with Manufacturer's recommended adhesive filler material.
- G. Job-Formed Corners:
 - 1. Outside Corners: Use straight pieces of maximum lengths possible. Form without producing discoloration (whitening) at bends.
 - 2. Inside Corners: Use straight pieces of maximum lengths possible.

** END OF SECTION **

SECTION 242020 RESINOUS FLOORING

PART 1 - GENERAL

1.1 SUMMARY

A. Section Includes:

1. High performance resinous flooring systems.

B. Related Sections:

1. Section 241080 "Joint Sealants" for sealants installed at joints in resinous flooring systems.

1.2 ACTION SUBMITTALS

- A. Product Data:** For each type of product indicated. Include Manufacturer's technical data, application instructions, and recommendations for each resinous flooring component required.

- B. Samples for Verification:** For each resinous flooring system required, 6 inches square, applied to a rigid backing by Installer for this Project.

1.3 INFORMATIONAL SUBMITTALS

- A. Installer Certificates:** Signed by Manufacturer certifying that installers comply with specified requirements.

- B. Material Certificates:** For each resinous flooring component, from Manufacturer.

- C. Material Test Reports:** For each resinous flooring system.

1.4 CLOSEOUT SUBMITTALS

- A. Maintenance Data:** For resinous flooring to include in maintenance manuals.

1.5 QUALITY ASSURANCE

- A. Installer Qualifications:** Manufacturer's authorized representative who is trained and approved for installation of flooring systems required for this Project.

1. Engage an installer who is certified in writing by resinous flooring Manufacturer as qualified to apply resinous flooring systems indicated.

- B. Source Limitations: Obtain primary resinous flooring materials, including primers, resins, hardening agents, grouting coats, and topcoats, from single source from single Manufacturer. Provide secondary materials, including patching and fill material, joint sealant, and repair materials, of type and from source recommended by Manufacturer of primary materials.
- C. Mockups: Apply mockups to verify selections made under sample submittals and to demonstrate aesthetic effects and set quality standards for materials and execution.
 - 1. Apply full thickness mockups on 48 inch square floor area selected by Owner.
 - a. Include 48 inch length of integral cove base with inside and outside corner.
 - 2. Simulate finished lighting conditions for Owner's review of mockups.
 - 3. Approved mockups may become part of the completed Work if undisturbed at time of Substantial Completion.
- D. Pre-installation Conference: Conduct conference at Project site.

1.6 DELIVERY, STORAGE, AND HANDLING

- A. Deliver materials in original packages and containers, with seals unbroken, bearing Manufacturer's labels indicating brand name and directions for storage and mixing with other components.

1.7 PROJECT CONDITIONS

- A. Environmental Limitations: Comply with resinous flooring Manufacturer's written instructions for substrate temperature, ambient temperature, moisture, ventilation, and other conditions affecting resinous flooring application.
- B. Lighting: Provide permanent lighting or, if permanent lighting is not in place, simulate permanent lighting conditions during resinous flooring application.
- C. Close spaces to traffic during resinous flooring application and for not less than 24 hours after application unless Manufacturer recommends a longer period.

PART 2 - PRODUCTS

2.1 MANUFACTURERS

- A. Basis-of-Design Product: Subject to compliance with requirements, provide the following basis-of design product or approved equal:
 - 1. Stonhard, Inc., **Stonblend GSI**, or equal.

2.2 MATERIALS

- A. VOC Content of Liquid Applied Flooring Components: Not more than 100 g/L when calculated according to 40 CFR 59, Subpart D (EPA Method 24):

2.3 HIGH PERFORMANCE RESINOUS FLOORING

- A. Resinous Flooring: Abrasion, impact, and chemical resistant, high performance aggregate filled, resin based, monolithic floor surfacing designed to produce a seamless floor and 4 inch integral cove base.
- B. System Characteristics:
 - 1. Color and Pattern: To be **selected by Architect** from Manufacturer's full range of colors and textures.
 - 2. Wearing Surface: Smooth, Manufacturer's standard wearing surface with moderate slip resistance.
 - 3. Overall System Thickness: 3/16 inch.
- C. Primer:
 - 1. **Stonblend Primer** or equal: Two component, penetrating, UV resistant epoxy primer.
 - 2. Eight (8) hours minimum curing time.
 - 3. Primer must be tacky during resinous flooring application. If primer becomes tack free, area must be re-primed prior to continuing application of resinous flooring system.
- D. Body Coats:
 - 1. **Stonblend GSI Base** or equal: Three component, troweled mortar consisting of epoxy resin, curing agent and colored quartz silica aggregate.
 - 2. Eight (8) hours minimum curing time.
- E. Topcoat:
 - 1. **Stonblend Grout Coat** or equal: Two component clear, UV resistant epoxy sealer.
 - 2. Squeegee application.
 - 3. Apply two coats with wet or wet application.
 - 4. Eight (8) hour minimum curing time.

F. Sealer:

1. **Stonshield Sealer** or equal: Two component, clear UV resistant, leveling epoxy sealer.
2. Squeegee application and back-rolled to uniform coating.
3. Twelve (12) hour minimum curing time.
4. After Stonshield sealer has cured, apply **Stonseal GS7 Clear Flat** (or equal) two component, non-reflective, waterborne, aliphatic polyurethane coating with medium nap roller. Apply second coat after six hours.

G. Apply resinous flooring system in accordance with Manufacturer's installation instructions for complete **Stonblend GSI** (or equal) system.

H. System Physical Properties: Provide resinous flooring system with the following minimum physical property requirements when tested according to test methods indicated:

1. Compressive Strength: 6000 psi per ASTM C 579.
2. Tensile Strength: 1500 psi per ASTM C 307.
3. Flexural Modulus of Elasticity: 2200 psi per ASTM C 580.
4. Water Absorption: 0.2% per ASTM C 413.
5. Coefficient of Thermal Expansion: $.18 \times 10^{-6}$ in./in.°F per ASTM C 531.
6. Impact Resistance: No chipping, cracking, or delamination and not more than 1/16-inch permanent indentation per MIL-D-3134, and >160 in./lbs per ASTM D 2794.
7. Resistance to Elevated Temperature: No slip or flow of more than 1/16 inch per MIL-D-3134.
8. Abrasion Resistance: 0.06 gm maximum weight loss per ASTM D 4060, CS-17.
9. Flammability: Self-extinguishing per ASTM D 635, Class 1 per ASTM E-648.
10. Hardness: 85 to 90, Shore D per ASTM D 2240.
11. Bond Strength: 250 psi per ASTM D 7234, 100 percent concrete failure per ACI 503R.
12. Heat Resistance: 140°F continuous exposure, 200°F for intermittent spills.
13. Cure Rate: 16 hours for foot traffic.

I. System Chemical Resistance: Test specimens of cured resinous flooring system are unaffected when tested according to ASTM D 1308 for 50 percent immersion in the following reagents for no fewer than seven days:

2.4 ACCESSORIES

- A. Patching and Fill Material: Resinous product of or approved by resinous flooring Manufacturer and recommended by Manufacturer for application indicated.

PART 3 - EXECUTION

3.1 PREPARATION

- A. General: Prepare and clean substrates according to resinous flooring Manufacturer's written instructions for substrate indicated. Provide clean, dry substrate for resinous flooring application.

- B. Concrete Substrates: Provide sound concrete surfaces free of laitance, glaze, efflorescence, curing compounds, form release agents, dust, dirt, grease, oil, and other contaminants incompatible with resinous flooring.
1. Roughen concrete substrates as follows:
 - a. Shot blast surfaces with an apparatus that abrades the concrete surface, contains the dispensed shot within the apparatus, and re-circulates the shot by vacuum pickup.
 - b. Comply with ASTM C 811 requirements unless Manufacturer's written instructions are more stringent.
 2. Repair damaged and deteriorated concrete according to resinous flooring Manufacturer's written instructions.
 3. Verify that concrete substrates are dry and moisture-vapor emissions are within acceptable levels according to Manufacturer's written instructions.
 - a. Perform anhydrous calcium chloride test, ASTM F 1869. Proceed with application of resinous flooring only after substrates have maximum moisture-vapor-emission rate of 3 lb of water/1000 sq. ft. of slab area in 24 hours.
 - b. Perform plastic sheet test, ASTM D 4263. Proceed with application only after testing indicates absence of moisture in substrates.
 - c. Perform relative humidity test using in situ probes, ASTM F 2170. Proceed with installation only after substrates have a maximum 75 percent relative humidity level measurement.
 4. Alkalinity and Adhesion Testing: Verify that concrete substrates have pH within acceptable range. Perform tests recommended by Manufacturer. Proceed with application only after substrates pass testing.
- C. Resinous Materials: Mix components and prepare materials according to resinous flooring Manufacturer's written instructions.
- D. Use patching and fill material to fill holes and depressions in substrates according to Manufacturer's written instructions.
- E. Treat control joints and other nonmoving substrate cracks to prevent cracks from reflecting through resinous flooring according to Manufacturer's written instructions.

3.2 APPLICATION

- A. General: Apply components of resinous flooring system according to Manufacturer's written instructions to produce a uniform, monolithic wearing surface of thickness indicated.
1. Coordinate application of components to provide optimum adhesion of resinous flooring system to substrate, and optimum intercoat adhesion.
 2. Cure resinous flooring components according to Manufacturer's written instructions. Prevent contamination during application and curing processes.
 3. At substrate expansion and isolation joints, comply with resinous flooring Manufacturer's written instructions.

- B. Apply primer over prepared substrate at Manufacturer's recommended spreading rate.
- C. 4 inch high Integral Cove Base: Apply cove base mix to wall surfaces before applying flooring. Apply according to Manufacturer's written instructions and details including those for taping, mixing, priming, troweling, sanding, and topcoating of cove base. Round internal and external corners.
- D. Apply self leveling slurry body coats in thickness indicated for flooring system.
 - 1. Broadcast aggregates at rate recommended by Manufacturer and, after resin is cured, remove excess aggregates to provide surface texture indicated.
- E. Apply troweled or screeded body coats in thickness indicated for flooring system. Hand or power trowel and grout to fill voids. When cured, remove trowel marks and roughness using method recommended by Manufacturer.
- F. Apply grout coat, of type recommended by resinous flooring Manufacturer, to fill voids in surface of final body coat and to produce wearing surface indicated.
- G. Apply topcoats in number indicated for flooring system and at spreading rates recommended in writing by Manufacturer.

3.3 FIELD QUALITY CONTROL

- A. Core Sampling: At the direction of Owner and at locations designated by Owner, take one core sample per 1000 sq. ft. of resinous flooring, or portion of, to verify thickness. For each sample that fails to comply with requirements, take two additional samples. Repair damage caused by coring and correct deficiencies.
- B. Material Sampling: Owner may at any time and any number of times during resinous flooring application require material samples for testing for compliance with requirements.
 - 1. **Owner will engage** an independent testing agency to take samples of materials being used. Material samples will be taken, identified, sealed, and certified in presence of Contractor.
 - 2. Testing agency will test samples for compliance with requirements, using applicable referenced testing procedures or, if not referenced, using testing procedures listed in Manufacturer's product data.
 - 3. If test results show applied materials do not comply with specified requirements, pay for testing, remove non-complying materials, prepare surfaces coated with unacceptable materials, and reapply flooring materials to comply with requirements.

3.4 PROTECTION

- A. Protect resinous flooring from damage and wear during the remainder of construction period. Use protective methods and materials, including temporary covering, recommended in writing by resinous flooring Manufacturer.

** END OF SECTION **

SECTION 242030 TILE CARPETING

PART 1 - GENERAL

1.1 SUMMARY

- A. Section includes modular, tufted textured loop carpet tile.
- B. Related Requirements:
 - 1. Section 242010 "Resilient Base and Accessories" for resilient wall base installed with carpet tile.

1.2 PREINSTALLATION MEETINGS

- A. Pre-installation Conference: Conduct conference at Project site.
 - 1. Review methods and procedures related to carpet tile installation including, but not limited to, the following:
 - a. Review delivery, storage, and handling procedures.
 - b. Review ambient conditions and ventilation procedures.
 - c. Review subfloor preparation procedures.

1.3 ACTION SUBMITTALS

- A. Product Data: For each type of product.
 - 1. Include Manufacturer's written data on physical characteristics, durability, and fade resistance.
 - 2. Include installation recommendations for each type of substrate.
- B. Shop Drawings: Show the following:
 - 1. Columns, doorways, enclosing walls or partitions, built-in cabinets, and locations where cutouts are required in carpet tiles.
 - 2. Carpet tile type, color, and dye lot.
 - 3. Type of subfloor.
 - 4. Type of installation.
 - 5. Pattern of installation.

6. Pattern type, location, and direction.
7. Pile direction.
8. Type, color, and location of insets and borders.
9. Type, color, and location of edge, transition, and other accessory strips.
10. Transition details to other flooring materials.

C. Samples: For each of the following products and for each color and texture required. Label each Sample with Manufacturer's name, material description, color, and pattern.

1. Carpet Tile: Full-size Sample.
2. Exposed Edge, Transition, and Other Accessory Stripping: 12-inch long Samples.

1.4 INFORMATIONAL SUBMITTALS

- A. Qualification Data: For Installer.
- B. Product Test Reports: For carpet tile, for tests performed by a qualified testing agency.
- C. Sample Warranty: For special warranty.

1.5 CLOSEOUT SUBMITTALS

- A. Maintenance Data: For carpet tiles to include in maintenance manuals. Include the following:
 1. Methods for maintaining carpet tile, including cleaning and stain removal products and procedures and Manufacturer's recommended maintenance schedule.
 2. Precautions for cleaning materials and methods that could be detrimental to carpet tile.

1.6 MAINTENANCE MATERIAL SUBMITTALS

- A. Furnish extra materials, from the same product run, that match products installed and that are packaged with protective covering for storage and identified with labels describing contents.
 1. Carpet Tile: Full-size units equal to **5 percent** of amount installed for each type indicated, but not less than one box of tile.

1.7 QUALITY ASSURANCE

- A. Installer Qualifications: An experienced installer who is certified by the International Certified Floor covering Installers Association at the Commercial II certification level.
- B. Fire-Test-Response Ratings: Provide carpet tile identical to those of assemblies tested for fire response according to NFPA 253 by a qualified testing agency.
- C. Mockups: Build mockups to verify selections made under Sample submittals and to demonstrate aesthetic effects and set quality standards for fabrication and installation.

1. Subject to compliance with requirements, approved mockups may become part of the completed Work if undisturbed at time of Substantial Completion.

1.8 DELIVERY, STORAGE, AND HANDLING

- A. Comply with CRI 104.

1.9 FIELD CONDITIONS

- A. Comply with CRI 104 for temperature, humidity, and ventilation limitations.
- B. Environmental Limitations: Do not deliver or install carpet tiles until spaces are enclosed and weather-tight, wet work in spaces is complete and dry, and ambient temperature and humidity conditions are maintained at occupancy levels during the remainder of the construction period.
- C. Do not install carpet tiles over concrete slabs until slabs have cured and are sufficiently dry to bond with adhesive and concrete slabs have pH and rH range recommended by carpet tile Manufacturer.
- D. Where demountable partitions or other items are indicated for installation on top of carpet tiles, install carpet tiles before installing these items.

1.10 WARRANTY

- A. Special Warranty for Carpet Tiles: Manufacturer agrees to repair or replace components of carpet tile installation that fail in materials or workmanship within specified warranty period.
 1. Warranty does not include deterioration or failure of carpet tile due to unusual traffic, failure of substrate, vandalism, or abuse.
 2. Failures include, but are not limited to, more than 10 percent edge raveling, snags, runs, dimensional stability, excess static discharge, loss of tuft bind strength, loss of face fiber, and delamination.
 3. Warranty: **15 year** non-prorated warranty from date of Substantial Completion.

PART 2 - PRODUCTS

2.1 CARPET TILE

- A. Products: Subject to compliance with requirements, provide the following:
 1. To be **selected by Owner** from Full line of **Interface** Modular Carpet Tile equal to (but not limited to) Architectural Plans Collection, Earth II and Wind II, Geometry II, Primary Stitch, Nagashi II, Extra Curricular, or Entropy.
- B. Color: As **selected by Owner** from Manufacturer's full range.
- C. Pattern: As **selected by Owner** from Manufacturer's full range.

- D. Fiber Content: 100 percent nylon 6, 6.
- E. Pile Characteristic: Cut-and-loop pile.
- F. Dye Method: 100% Solution Dye.
- G. Yarn Count: 10/in.
- H. Pile Height: .15 in.
- I. Pile Thickness: .103.
- J. Pile Density: 6291.
- K. Primary Backing / Backcoating: Glas Bac RE or equal by Interface Floor.
- L. Secondary Backing: Manufacturer's standard material.
- M. Size: 19.69 in. x 19.69 in.
- N. Applied Soil-Resistance Treatment: Manufacturer's standard material.
 - 1 Interface Floor **Protekt** or equal
- O. Antimicrobial Treatment: Manufacturer's standard material.
- P. Performance Characteristics: As follows:
 - 1. Appearance Retention Rating: Severe traffic, 3.5 minimum according to ASTM D 7330.
 - 2. Critical Radiant Flux Classification: Not less than 0.22 W/sq. cm.
 - 3. Dry Breaking Strength: Not less than 100 lbf according to ASTM D 2646.
 - 4. Tuft Bind: Not less than 10 lbf according to ASTM D 1335.
 - 5. Delamination: Not less than 4 lbf/in. according to ASTM D 3936.
 - 6. Dimensional Tolerance: Within 1/32 inch of specified size dimensions, as determined by physical measurement.
 - 7. Dimensional Stability: 0.2 percent or less according to ISO 2551 (Aachen Test).
 - 8. Resistance to Insects: Comply with AATCC 24.
 - 9. Colorfastness to Crocking: Not less than 4, wet and dry, according to AATCC 165.
 - 10. Colorfastness to Light: Not less than 4 after 60 AFU (AATCC fading units) according to AATCC 16, Option E.
 - 11. Antimicrobial Activity: Not less than 2-mm halo of inhibition for gram-positive bacteria, not less than 1-mm halo of inhibition for gram-negative bacteria, and no fungal growth, according to AATCC 174.
 - 12. Electrostatic Propensity: Less than 2 kV according to AATCC 134. Provide anti-static carpet tiles rated in Data Rooms and Computer Rooms.

2.2 INSTALLATION ACCESSORIES

- A. Trowelable Leveling and Patching Compounds: Latex-modified, hydraulic-cement-based formulation provided or recommended by carpet tile Manufacturer.

- B. Adhesives: Water-resistant, mildew-resistant, non-staining, pressure-sensitive type to suit products and subfloor conditions indicated, that complies with flammability requirements for installed carpet tile and is **recommended by carpet tile Manufacturer** for releasable installation. Do not use adhesive that has not been accepted by the Manufacturer for use with their carpet tiles.
- C. Metal Edge/Transition Strips: Stainless steel with profile to be **selected by Owner** from Manufacturer's full range of non-standard profiles, of height required to protect exposed edge of carpet, and of maximum lengths to minimize running joints. Provide trowelable leveling and patching compounds as required to align carpet tile with top of transition strip. Replace transition strip, at the direction of the Owner, where the transition strip creates a trip hazard.

PART 3 - EXECUTION

3.1 EXAMINATION

- A. Examine substrates, areas, and conditions, with Installer present, for compliance with requirements for maximum moisture content, alkalinity range, installation tolerances, and other conditions affecting carpet tile performance. Examine carpet tile for type, color, pattern, and potential defects.
- B. Concrete Subfloors: Verify that concrete slabs comply with ASTM F 710 and the following:
 1. Slab substrates are dry and free of curing compounds, sealers, hardeners, and other materials that may interfere with adhesive bond. Determine adhesion and dryness characteristics by performing bond and moisture tests recommended by carpet tile Manufacturer.
 2. Subfloor finishes comply with requirements specified in Section 240020 "Cast-in-Place Concrete" for slabs receiving carpet tile.
 3. Subfloors are free of cracks, ridges, depressions, scale, and foreign deposits.
 4. By installing carpet tile, installer accepts substrate and is responsible for carpet installation including all requirements from carpet tile Manufacturer for floor prep. Carpet tile installer is responsible to replacing tile for any defect associated with the concrete floor substrate including requirements associated with adhesive application.
- C. Proceed with installation only after unsatisfactory conditions have been corrected.

3.2 PREPARATION

- A. General: Comply with CRI 104, Section 6.2, "Site Conditions; Floor Preparation," and with carpet tile Manufacturer's written installation instructions for preparing substrates indicated to receive carpet tile installation.
- B. Use trowelable leveling and patching compounds, according to Manufacturer's written instructions, to fill cracks, holes, depressions, and protrusions in substrates. Fill or level cracks, holes and depressions 1/8 inch wide or wider and protrusions more than 1/32 inch unless more stringent requirements are required by Manufacturer's written instructions.

- C. Remove coatings, including curing compounds, and other substances that are incompatible with adhesives and that contain soap, wax, oil, or silicone, without using solvents. Use mechanical methods recommended in writing by carpet tile Manufacturer.
- D. Clean metal substrates of grease, oil, soil and rust, and prime if directed by adhesive Manufacturer. Rough sand painted metal surfaces and remove loose paint. Sand aluminum surfaces, to remove metal oxides, immediately before applying adhesive.
- E. Broom and vacuum clean substrates to be covered immediately before installing carpet tile.

3.3 INSTALLATION

- A. General: Comply with CRI 104, Section 14, "Carpet Modules," and with carpet tile Manufacturer's written installation instructions.
- B. Installation Method: Glue down; install every tile with full-spread, releasable, pressure-sensitive adhesive. Recommended by Manufacturer for carpet tile installed and substrate installed on.
- C. Maintain dye lot integrity. Do not mix dye lots in same area.
- D. Cut and fit carpet tile to butt tightly to vertical surfaces, permanent fixtures, and built-in furniture including cabinets, pipes, outlets, edgings, and thresholds. Bind or seal cut edges as recommended by carpet tile Manufacturer.
- E. Extend carpet tile into toe spaces, door reveals, closets, open-bottomed obstructions, removable flanges, alcoves, and similar openings.
- F. Maintain reference markers, holes, and openings that are in place or marked for future cutting by repeating on finish flooring as marked on subfloor. Use nonpermanent, non-staining marking device.
- G. Install pattern parallel to walls and borders unless noted otherwise by Owner.

3.4 CLEANING AND PROTECTION

- A. Perform the following operations immediately after installing carpet tile:
 1. Remove excess adhesive, seam sealer, and other surface blemishes using cleaner recommended by carpet tile Manufacturer.
 2. Remove yarns that protrude from carpet tile surface.
 3. Vacuum carpet tile using commercial machine with face-beater element.
- B. Protect installed carpet tile to comply with CRI 104, Section 16, "Protecting Indoor Installations."
- C. Protect carpet tile against damage from construction operations and placement of equipment and fixtures during the remainder of construction period. Use protection methods indicated or recommended in writing by carpet tile Manufacturer.

**** END OF SECTION ****

**SECTION 243010
ACOUSTICAL PANEL CEILINGS**

PART 1 - GENERAL

1.1 SUMMARY

- A. This Section includes, following:
 - 1. Suspension systems for acoustical panel ceilings.
 - 2. Acoustical panels.

1.2 PREINSTALLATION MEETINGS

- A. Pre-installation Conference: Conduct conference at Project site.

1.3 ACTION SUBMITTALS

- A. Product Data: For each type of product.
- B. Samples: For each exposed product and for each color and texture specified, 6 inches in size.
- C. Samples for Verification: For each component indicated and for each exposed finish required, prepared on Samples of size indicated below.
 - 1. Acoustical Panel: Set of 6-inch-square Samples of each type, color, pattern, and texture.
 - 2. Exposed Suspension system Members, Moldings, and Trim: Set of 6-inch long Samples of each type, finish, and color.

1.4 INFORMATIONAL SUBMITTALS

- A. Coordination Drawings: Reflected Ceiling Plans, drawn to scale, on which the following items are shown and coordinated with each other, using input from installers of the items involved:
 - 1. Suspended ceiling components.
 - 2. Structural members to which suspension systems will be attached.
 - 3. Items penetrating finished ceiling including the following:
 - a. Lighting fixtures.
 - b. Air outlets and inlets.
 - c. Access panels.
 - 4. Perimeter moldings.
- B. Qualification Data: For testing agency, qualified according to NVLAP for testing indicated.

- C. Product Test Reports: For each acoustical panel ceiling, for tests performed by a qualified testing agency.
- D. Evaluation Reports: For each acoustical panel ceiling suspension system and anchor and fastener type, from ICC-ES.
- E. Field quality control reports.

1.5 CLOSEOUT SUBMITTALS

- A. Maintenance Data: For finishes to include in maintenance manuals.

1.6 DELIVERY, STORAGE, AND HANDLING

- A. Deliver acoustical panels, suspension system components, and accessories to Project site in original, unopened packages and store them in a fully enclosed, conditioned space where they will be protected against damage from moisture, humidity, temperature extremes, direct sunlight, surface contamination, and other causes.
- B. Before installing acoustical panels, permit them to reach room temperature and maintain a stabilized moisture content.
- C. Handle acoustical panels carefully to avoid chipping edges or damaging units in any way.

1.7 FIELD CONDITIONS

- A. Environmental Limitations: Do not install acoustical panel ceilings until spaces are enclosed and weatherproof, wet work in spaces is complete and dry, work above ceilings is complete, and ambient temperature and humidity conditions are maintained at the levels indicated for Project when occupied for its intended use.

1.8 PERFORMANCE REQUIREMENTS

- A. Fire Performance Characteristics:
 - 1. Surface Burning Characteristics: Provide acoustical panels with the following surface-burning characteristics complying with ASTM E 1264 for Class A, when evaluated meeting requirements of ASTM E84:
 - a. Flame Spread: 25 maximum.
 - b. Smoke Developed: 50 maximum.

- B. Seismic Requirements:
 - 1. Seismic Category: **A**.
 - 2. Ceiling installation to conform to basic minimum standards in accordance with ASTM C636.

- C. Microbial and Mold Resistance: Provide acoustical panels treated with Manufacturer's standard antimicrobial formulation that inhibits fungus, mold, mildew, and gram-positive and gram-negative bacteria and showing no mold, mildew, or bacterial growth when tested according to ASTM D 3273 and evaluated according to ASTM D 3274 or ASTM G 21.

- D. Tolerances: Installed ceiling surfaces shall be within following:
 - 1. Location Variation: 1/8 inch.
 - 2. Level: Complete system with all supported loads, such as light fixtures, diffusers and like items associated with ceiling, shall be within tolerance of 1/8 inch in 12'-0", and not exceed 1/4 inch cumulatively, any direction, and deflection of any component shall not exceed L/360 of span.

1.9 QUALITY ASSURANCE

- A. Manufacturer Qualifications: Manufacturer shall specialize in production of primary product under this Section and have 3 years minimum documented experience in production of type and quality required for work.

- B. Installer Qualifications: Installer shall specialize in performing work of this Section and have 3 years minimum documented experience in detailing, installation and maintenance of type and quality required for work.

1.10 EXTRA MATERIALS

- A. Products: Furnish **5 percent** of amount installed of each acoustical unit and suspension system. Furnish full size units matching units installed, packaged with protective covering for storage, and identified with appropriate labels.

PART 2 - PRODUCTS

2.1 ACOUSTICAL CEILING PANELS

- A. Manufacturer's: Subject to compliance with requirements, provide products by one of the following:
 - 1. **Armstrong World Industries, Inc.**; Basis-of-Design
 - 2. CertainTeed Corp.
 - 3. Chicago Metallic Corporation.
 - 4. USG Interiors, Inc.; Subsidiary of USG Corporation.

- B. Standards: Comply with ASTM E 1264.
- C. Panel Colors and Patterns: To be **selected by Owner** from Manufacturer's full range of standard colors.
- D. Type and Form: Type III, mineral base with painted finish; Form 2, water felted.
- E. Pattern: To be **selected by Owner** from Manufacturer's full range of standard patterns.
- F. LR: 0.75 minimum.
- G. NRC: 0.55 minimum.
- H. CAC: 30 minimum.
- I. Thickness: 5/8 inch thick minimum.
- J. Edge Condition: To be **selected by Owner** from Manufacturer's full range of standard edge conditions..
- K. Modular Size: 24 by 48 inches.

2.2 METAL SYSPENSION SYSTEMS

- A. Manufacturer's: Subject to compliance with requirements, provide products by one of the following:
 - 1. **Armstrong World Industries, Inc.**; Basis-of-Design
 - 2. CertainTeed Corp.
 - 3. Chicago Metallic Corporation.
 - 4. USG Interiors, Inc.; Subsidiary of USG Corporation.
- B. Standards: Comply with ASTM C 636.
- C. Finishes and Colors:
 - 1. General: Comply with NAAMM's "Metal Finishes Manual for Architectural and Metal Products" for recommendations for applying and designating finishes. Provide Manufacturer's standard factory-applied finish for type of system indicated.
 - 2. Color: To be **selected by Owner** from Manufacturer's full range of standard suspension system colors.
- D. Materials:
 - 1. Attachment Devices - Concrete: Corrosion resistant, anchor or actuated type fasteners with means for attaching hangers and capable of sustaining, without failure, loads as follows, for required structural classification, imposed by actual ceiling hanger, including items supported by ceiling construction, as determined when evaluated, meeting requirements of ASTM E488 or ASTM E1190, as applicable, conducted by an independent testing agency.

- a. Anchor Fasteners: Load equal to 5 times load indicated in ASTM C635, Table 1, Direct Hung.
 - b. Actuated Fasteners: Load equal to 10 times load indicated in ASTM C635, Table 1, Direct Hung.
2. Wire Hangers, Braces, and Ties: ASTM A641, hot-dip zinc coated steel wire, Class 1 coating, soft temper, pre-stretched; yield stress load of 3 times minimum design load indicated in ASTM C635, Table 1, Direct Hung for required structural classification, but 0.106 in thick minimum.
 3. Hanger rods and Flat hangers: Mild steel, zinc coated or protected with rust-inhibitive paint.
 4. Angle Hangers: ASTM A653, hot-dip zinc coated sheet angles, G90 Coating Designation, 0.04 inch thick minimum.
 5. Metal Edge Moldings and Trim: Metal of types and profiles which provide finish edges at openings and penetrations in ceiling and which correspond with edge detail of acoustical units and suspension system, with hemmed edges and as selected by Owner. Provide square trim pieces as required to provide tight fit with adjacent finish surface.
 6. Suspension Grid: Provide the following:
 - a. Wide Face, Capped, Double-Web Steel: Cold rolled, hot-dip zinc coated steel (aluminum in wet areas); direct hung, exposed inverted tee shape, ASTM C635 Intermediate Duty System, with 15/16 inch wide flanges; Prelude 15/16”.
 - b. Narrow Face, Capped, Double-Web Steel for specific locations as indicated in the documents: Cold rolled, hot-dip zinc coated steel, direct hung, exposed inverted tee shape, ASTM C635 Intermediate Duty System, with 9/16 inch wide flanges; Suprafine 9/16”.

2.3 SOURCE LIMITATIONS

- A. Obtain products and materials from single source from a single Manufacturer.

2.4 ACCESSORIES

- A. Acoustical Sealants: Acoustical sealant, non-sag, paintable, and non-staining meeting instructions and recommendations of Manufacturer.

PART 3 - EXECUTION

3.1 EXAMINATION

- A. Examine substrates, areas, and conditions, including structural framing to which acoustical panel ceilings attach or abut, with Installer present, for compliance with requirements specified in this and other Sections that affect ceiling installation and anchorage and with requirements for installation tolerances and other conditions affecting performance of acoustical panel ceilings.

- B. Examine acoustical panels before installation. Reject acoustical panels that are wet, moisture damaged, or mold damaged.
- C. Proceed with installation only after unsatisfactory conditions have been corrected.

3.2 PREPARATION

- A. Measure each ceiling area and establish layout of acoustical panels to balance border widths at opposite edges of each ceiling. Avoid using less-than-half-width panels at borders, and comply with layout shown on reflected ceiling plans.

3.3 INSTALLATION

- A. General: Comply with ASTM C 636 and CISCA's "Ceiling Systems Handbook".
- B. Suspension Systems:
 - 1. Supported Loads: Light fixtures, diffusers or like items associated with ceiling shall not be supported from ceiling suspension system if weight of such items exceed capability of suspension system or if tolerances of suspension system will be exceeded. In such cases, load shall be supported by supplementary hangers or shall be independently supported.
 - 2. Hangers:
 - a. Spacing: 4'-0" maximum centers, with hangers 6 inches maximum from ends of carrying channels or main runners.
 - b. Support hangers directly from building structural members. Do not support hangers from metal deck, bracing; pipes, ducts, conduits and respective supports, and like items.
 - c. Install hangers plumb and free from contact with insulation or other objects within ceiling plenum that are not part of supporting structure or of ceiling suspension system.
 - d. Splay hangers only where required and to miss obstructions; offset resulting horizontal forces by bracing, countersplaying, or other equally effective means.
 - e. Where width of ducts and other construction within ceiling plenum produces hanger spacings that interfere with location of hangers at spacings required to support standard suspension system members, install supplemental suspension members and hangers in form of trapezes or equivalent devices.
 - f. Secure wire hangers to ceiling-suspension members and to supports above with a minimum of three tight turns. Connect hangers directly either to structures or to inserts, eye screws, or other devices that are secure and appropriate for substrate and that will not deteriorate or otherwise fail due to age, corrosion, or elevated temperatures.
 - g. Secure flat, angle, channel, and rod hangers to structure, including intermediate framing members, by attaching to inserts, eye screws, or other devices that are secure and appropriate for both the structure to which hangers are attached and the type of hanger involved. Install hangers in a manner that will not cause them to deteriorate or fail due to age, corrosion, or elevated temperatures.

- h. Do not support ceilings directly from permanent metal forms or floor deck. Fasten hangers to cast-in-place hanger inserts, post-installed mechanical or adhesive anchors, or power-actuated fasteners that extend through forms into concrete.
 - i. When steel framing does not permit installation of hanger wires at spacing required, install carrying channels or other supplemental support for attachment of hanger wires.
 - j. Size supplemental suspension members and hangers to support ceiling loads within performance limits established by referenced standards and publications.
- C. Secure bracing wires to ceiling suspension members and to supports with a minimum of four tight turns. Suspend bracing from building's structural members as required for hangers, without attaching to permanent metal forms, steel deck, or steel deck tabs. Fasten bracing wires into concrete with cast-in-place or post-installed anchors.
- D. Install edge moldings and trim of type indicated at perimeter of acoustical ceiling area and where necessary to conceal edges of acoustical panels.
 - 1. Apply acoustical sealant in a continuous ribbon concealed on back of vertical legs of moldings before they are installed.
 - 2. Screw attach moldings to substrate at intervals not more than 16 inches o.c. and not more than 3 inches from ends, leveling with ceiling suspension system to a tolerance of 1/8 inch in 12 feet. Miter corners accurately and connect securely.
 - 3. Do not use exposed fasteners, including pop rivets, on moldings and trim.
- E. Install suspension system runners so they are square and securely interlocked with one another. Remove and replace dented, bent, or kinked members.
- F. Install acoustical panels with undamaged edges and fit accurately into suspension system runners and edge moldings. Scribe and cut panels at borders and penetrations to provide a neat, precise fit.
 - 1. Arrange directionally patterned acoustical panels as follows:
 - a. Install panels with pattern running in one direction.
 - 2. For square edged panels, install panels with edges fully hidden from view by flanges of suspension system runners and moldings.
 - 3. For reveal edged panels on suspension system runners, install panels with bottom of reveal in firm contact with top surface of runner flanges.
 - 4. For reveal edged panels on suspension system members with box shaped flanges, install panels with reveal surfaces in firm contact with suspension system surfaces and panel faces flush with bottom face of runners.
 - 5. Paint cut edges of panel remaining exposed after installation; match color of exposed panel surfaces using coating recommended in writing for this purpose by acoustical panel Manufacturer.
 - 6. Protect lighting fixtures and air ducts to comply with requirements indicated for fire-resistance-rated assembly.
- G. Acoustical Panels:

1. Equipment Clips: Provide equipment clips at each corner of each light fixture and diffuser supported by suspension system.
2. Hold Down Clips: Provide hold down clips spaced 2 feet on center maximum for acoustical panels where following conditions occur, except do not exceed spacing required by governing authorities, fire resistance ratings, or by Manufacturer :
 - a. Weight of panel is less than 1 lb/ft².
 - b. Space above ceiling is used as an air plenum.
 - c. Ceiling is located in a high humidity space.
 - d. Ceiling is located in building entrance vestibule or outdoor location.
 - e. Required by governing regulations or for fire resistance ratings.
 - f. As instructed or recommended by panel Manufacturer.

3.4 FIELD QUALITY CONTROL

A. Testing and Special Inspections:

1. Provide for testing and special inspection of ceiling hangers, anchors and fasteners meeting requirements of codes and regulations of authorities having jurisdiction over the Work.
2. Perform testing and inspecting of completed installations of areas in successive stages. Do not proceed with installations of acoustical panel ceiling hangers for the next area until test results for previously completed installations show compliance with requirements.
3. Acoustical panel ceiling hangers and anchors and fasteners will be considered defective if they do not pass tests and inspections.
4. Prepare test and inspection reports.

3.5 CLEANING

- #### A.
- Clean exposed surfaces of acoustical panel ceilings, including trim, edge moldings, and suspension system members. Comply with Manufacturer's written instructions for cleaning and touchup of minor finish damage. Remove and replace ceiling components that cannot be successfully cleaned and repaired to permanently eliminate evidence of damage.

** END OF SECTION **

**SECTION 244010
EXTERIOR PAINTING**

PART 1 - GENERAL

1.1 SUMMARY

- A. Section includes surface preparation and the application of paint systems on exterior substrates:
 - 1. Steel.
 - 2. Galvanized metal.
- B. Related Requirements:
 - 1. Section 244020 "Interior Painting" for surface preparation and the application of paint systems on interior substrates.

1.2 DEFINITIONS

- A. Gloss Level 5: 35 to 70 units at 60 degrees, according to ASTM D 523.

1.3 ACTION SUBMITTALS

- A. Product Data: For each type of product. Include preparation requirements and application instructions.
- B. Samples for Verification: For each type of paint system and each color and gloss of topcoat.
 - 1. Submit Samples on rigid backing, 8 inches square.
 - 2. Step coats on Samples to show each coat required for system.
 - 3. Label each coat of each Sample.
 - 4. Label each Sample for location and application area.
- C. Product List: For each product indicated, include the following:
 - 1. Cross-reference to paint system and locations of application areas.
 - 2. Printout of current "MPI Approved Products List" for each product category specified, with the proposed product highlighted.
 - 3. VOC content.

1.4 MAINTENANCE MATERIAL SUBMITTALS

- A. Furnish extra materials, from the same product run, that match products installed and that are packaged with protective covering for storage and identified with labels describing contents.
 - 1. Paint: **5 percent**, but not less than 1 gal. of each material and color applied.

1.5 DELIVERY, STORAGE, AND HANDLING

- A. Store materials not in use in tightly covered containers in well ventilated areas with ambient temperatures continuously maintained at not less than 45 deg F.
 - 1. Maintain containers in clean condition, free of foreign materials and residue.
 - 2. Remove rags and waste from storage areas daily.

1.6 FIELD CONDITIONS

- A. Apply paints only when temperature of surfaces to be painted and ambient air temperatures are between 50 and 95 deg F.
- B. Do not apply paints in snow, rain, fog, or mist; when relative humidity exceeds 85 percent; at temperatures less than 5 deg F above the dew point; or to damp or wet surfaces.

PART 2 - PRODUCTS

2.1 MANUFACTURERS

- A. Manufacturers: Subject to compliance with requirements, available products that may be incorporated into the Work include, but are not limited to, the following:
 - 1. The Sherwin-Williams Company
 - 2. Tnemec

2.2 PAINT, GENERAL

- A. MPI Standards: Provide products that comply with MPI standards indicated and that are listed in its "MPI Approved Products List."
- B. Multiple Coats: Painting contractor to provide different color primer coat from finish coat for verification of proper application of each coat specified.
- C. Material Compatibility:
 - 1. Provide materials for use within each paint system that are compatible with one another and substrates indicated, under conditions of service and application as demonstrated by Manufacturer, based on testing and field experience.
 - 2. For each coat in a paint system, provide products recommended in writing by Manufacturers of topcoat for use in paint system and on substrate indicated.
- D. VOC Content: Provide materials that comply with VOC limits of authorities having jurisdiction.
- E. Colors: To **be selected by Owner** from Manufacturer's full range.

2.3 HIGH PERFORMANCE COATING

A. Steel:

1. Primer: **SW Macropoxy 646 Fast Cure Epoxy, B58-600 series**, 4-6 mil thickness, with SP3 Power Tool Cleaning. For galvanized members, see below for primer requirements.
Tnemec: Chembuild Series 135, 4-6 mil thickness, with SP3 Power Tool Cleaning. For galvanized members, see below for primer requirements.
2. Intermediate Coat: **SW Acrolon 218 HS Polyurethane Semi-Gloss, B65-650 series** or **Tnemec Endura-Shield Series 73**, 3-4 mil thickness.
3. Top Coat: **SW Acrolon 218 HS Polyurethane Semi-Gloss, B65-650 series** or **Tnemec Endura-Shield Series 73**, 3-4 mil thickness.

B. Galvanized Metal:

1. Surface Prep: Hot dip galvanized (see structural drawings) with surface preparation by cleaning surface and removing all contaminants (ie: chromates, passivating agents, oils, etc.). Solvent Clean in accordance with SSPC-SP 1. Apply a test-patch (2-4 sq. ft.) and check for adhesion per ASTM D3359 after one week of curing.
2. Primer: **SW Macropoxy 646 Fast Cure Epoxy, B58-600 series**, 4-6 mil thickness, with SP3 Power Tool Cleaning. For galvanized members, see below for primer requirements.
Tnemec: Chembuild Series 135, 4-6 mil thickness, with SP3 Power Tool Cleaning. For galvanized members, see below for primer requirements.
3. Intermediate Coat: **SW Acrolon 218 HS Polyurethane Semi-Gloss, B65-650 series** or **Tnemec Endura-Shield Series 73**, 3-4 mil thickness.
4. Top Coat SW: **Acrolon 218 HS Polyurethane Semi-Gloss, B65-650 series** or **Tnemec Endura-Shield Series 73**, 3-4 mil thickness.

2.4 SOURCE QUALITY CONTROL

A. Testing of Paint Materials: Owner reserves the right to invoke the following procedure:

1. **Owner will engage** the services of a qualified testing agency to sample paint materials. Contractor will be notified in advance and may be present when samples are taken. If paint materials have already been delivered to Project site, samples may be taken at Project site. Samples will be identified, sealed, and certified by testing agency.
2. Testing agency will perform tests for compliance with product requirements.
3. Owner may direct Contractor to stop applying paints if test results show materials being used do not comply with product requirements. Contractor shall remove non-complying paint materials from Project site, pay for testing, and repaint surfaces painted with rejected materials. Contractor will be required to remove rejected materials from previously painted surfaces if, on repainting with complying materials, the two paints are incompatible.

PART 3 - EXECUTION

3.1 EXAMINATION

- A. Examine substrates and conditions, with Applicator present, for compliance with requirements for maximum moisture content and other conditions affecting performance of the Work.
- B. Verify suitability of substrates, including surface conditions and compatibility with existing finishes and primers.
- C. Proceed with coating application only after unsatisfactory conditions have been corrected.
 - 1. Application of coating indicates acceptance of surfaces and conditions.

3.2 PREPARATION

- A. Comply with Manufacturer's written instructions and recommendations in "MPI Manual" applicable to substrates and paint systems indicated.
- B. Remove hardware, covers, plates, and similar items already in place that are removable and are not to be painted. If removal is impractical or impossible because of size or weight of item, provide surface-applied protection before surface preparation and painting.
 - 1. After completing painting operations, use workers skilled in the trades involved to reinstall items that were removed. Remove surface applied protection.
- C. Clean substrates of substances that could impair bond of paints, including dust, dirt, oil, grease, and incompatible paints and encapsulants.
 - 1. Remove incompatible primers and re-prime substrate with compatible primers or apply tie coat as required to produce paint systems indicated.
- D. Steel Substrates: Remove rust, loose mill scale, and shop primer if any. Clean using methods recommended in writing by paint Manufacturer but not less than the following:
 - 1. SSPC-SP 3, "Power Tool Cleaning."
- E. Shop-Primed Steel Substrates: Clean field welds, bolted connections, and abraded areas of shop paint, and paint exposed areas with the same material as used for shop priming to comply with SSPC-PA 1 for touching up shop-primed surfaces.
- F. Galvanized Metal Substrates: Remove grease and oil residue from galvanized sheet metal by mechanical methods to produce clean, lightly etched surfaces that promote adhesion of subsequently applied paints.

3.3 APPLICATION

- A. Apply paints according to Manufacturer's written instructions and recommendations in "MPI Manual."

1. Use applicators and techniques suited for paint and substrate indicated.
 2. Paint surfaces behind movable items same as similar exposed surfaces. Before final installation, paint surfaces behind permanently fixed items with prime coat only.
 3. Paint both sides and edges of exterior doors and entire exposed surface of exterior door frames.
 4. Paint entire exposed surface of window frames and sashes.
 5. Do not paint over labels of independent testing agencies or equipment name, identification, performance rating, or nomenclature plates.
 6. Primers specified in painting schedules may be omitted on items that are factory primed or factory finished if acceptable to topcoat Manufacturers.
- B. Tint undercoats same color as topcoat, but tint each undercoat a lighter shade to facilitate identification of each coat if multiple coats of same material are to be applied. Provide sufficient difference in shade of undercoats to distinguish each separate coat.
- C. If undercoats or other conditions show through topcoat, apply additional coats until cured film has a uniform paint finish, color, and appearance.
- D. Apply paints to produce surface films without cloudiness, spotting, holidays, laps, brush marks, roller tracking, runs, sags, ropiness, or other surface imperfections. Cut in sharp lines and color breaks.
- E. Painting exposed HVAC and Electrical Work:
1. Paint the following work where exposed to view:
 - a. Exposed mechanical equipment not factory finished as directed by the Owner.
 - b. Exposed steel including lintels, frames (not factory finished), doors (not factory finished), etc.

3.4 FIELD QUALITY CONTROL

- A. Dry Film Thickness Testing: Owner may engage the services of a qualified testing and inspecting agency to inspect and test paint for dry film thickness.
1. Contractor shall touch up and restore painted surfaces damaged by testing.
 2. If test results show that dry film thickness of applied paint does not comply with paint Manufacturer's written recommendations, Contractor shall pay for testing and apply additional coats as needed to provide dry film thickness that complies with paint Manufacturer's written recommendations.

3.5 CLEANING AND PROTECTION

- A. At end of each workday, remove rubbish, empty cans, rags, and other discarded materials from Project site.
- B. After completing paint application, clean spattered surfaces. Remove spattered paints by washing, scraping, or other methods. Do not scratch or damage adjacent finished surfaces.

- C. Protect work of other trades against damage from paint application. Correct damage to work of other trades by cleaning, repairing, replacing, and refinishing, as approved by Owner, and leave in an undamaged condition.
- D. At completion of construction activities of other trades, touch up and restore damaged or defaced painted surfaces.

3.6 EXTERIOR PAINTING SCHEDULE

A. Steel Substrates:

1. High Performance Coating:

- a. Apply in accordance with Manufacturers requirements and recommendations.
- b. Color to be **selected by Owner**.

B. Galvanized-Metal Substrates:

1. High Performance Coating:

- a. Apply in accordance with Manufacturers requirements and recommendations.
- b. Color to be **selected by Owner**.

**** END OF SECTION ****

SECTION 244020 INTERIOR PAINTING

PART 1 - GENERAL

1.1 RELATED DOCUMENTS

- A. Drawings and general provisions of the Contract, including General and Supplementary Conditions and Division 01 Specification Sections, apply to this Section.

1.2 SUMMARY

- A. Section includes surface preparation and the application of paint systems on interior substrates.

1. Concrete.
2. Concrete masonry units (CMU).
3. Steel.
4. Cast iron.
5. Galvanized metal.
6. Wood.
7. Gypsum board.

- B. Related Requirements:

1. Section 244010 "Exterior Painting" for surface preparation and the application of paint systems on exterior substrates.

1.3 DEFINITIONS

- A. Gloss Level 3: 10 to 25 units at 60 degrees and 10 to 35 units at 85 degrees, according to ASTM D 523.
- B. Gloss Level 5: 35 to 70 units at 60 degrees, according to ASTM D 523.

1.4 ACTION SUBMITTALS

- A. Product Data: For each type of product. Include preparation requirements and application instructions.
- B. Samples for Verification: For each type of paint system and in each color and gloss of topcoat.
 1. Submit Samples on rigid backing, 8 inches square.
 2. Step coats on Samples to show each coat required for system.
 3. Label each coat of each Sample.
 4. Label each Sample for location and application area.

- C. Product List: For each product indicated, include the following:
1. Cross reference to paint system and locations of application areas. Use same designations indicated on Drawings and in schedules.
 2. Printout of current "MPI Approved Products List" for each product category specified in Part 2, with the proposed product highlighted.
 3. VOC content.

1.5 MAINTENANCE MATERIAL SUBMITTALS

- A. Furnish extra materials, from the same product run, that match products installed and that are packaged with protective covering for storage and identified with labels describing contents.
1. Paint: **5 percent**, but not less than 1 gal. of each material and color applied.

1.6 DELIVERY, STORAGE, AND HANDLING

- A. Store materials not in use in tightly covered containers in well-ventilated areas with ambient temperatures continuously maintained at not less than 45 deg F.
1. Maintain containers in clean condition, free of foreign materials and residue.
 2. Remove rags and waste from storage areas daily.

1.7 FIELD CONDITIONS

- A. Apply paints only when temperature of surfaces to be painted and ambient air temperatures are between 50 and 95 deg F.
- B. Do not apply paints when relative humidity exceeds 85 percent; at temperatures less than 5 deg F above the dew point; or to damp or wet surfaces.

PART 2 - PRODUCTS

2.1 MANUFACTURERS

- A. Manufacturers: Subject to compliance with requirements, available Manufacturers offering products that may be incorporated into the Work include, but are not limited to, the following:
1. Behr Process Corporation.
 2. Benjamin Moore & Co.
 3. Duron, Inc.
 4. M.A.B. Paints.
 5. Pratt & Lambert.
 6. **Sherwin-Williams Company** (The), Basis-of-Design Products.

- B. Products: Subject to compliance with requirements, available products that may be incorporated into the Work include, but are not limited to products listed in other Part 2 articles for the paint category indicated.

2.2 PAINT GENERAL

- A. MPI Standards: Provide products that comply with MPI standards indicated and that are listed in its "MPI Approved Products List."
- B. Fire Walls: Painting contractor to paint fire rating designation on each fire wall above ceiling indicating design rating of wall. Template for text and location for designation of each sign and fire wall to be approved by Owner and Code Official in field.
- C. Multiple Coats: Painting contractor to provide different color primer coat from finish coat and for each coat of block filler for verification of proper application of each coat specified.
- D. Material Compatibility:
 - 1. Provide materials for use within each paint system that are compatible with one another and substrates indicated, under conditions of service and application as demonstrated by Manufacturer, based on testing and field experience.
 - 2. For each coat in a paint system, provide products recommended in writing by Manufacturers of topcoat for use in paint system and on substrate indicated.
- E. VOC Content: Products shall comply with VOC limits of authorities having jurisdiction.
- F. Colors: To be **selected by Owner** from Manufacturer's full range.

2.3 BLOCK FILLERS

- A. Block Filler, Latex, Interior/Exterior: **MPI #4.**
 - 1. **Sherwin Williams, PrepRite** Interior / Exterior Block Filler, **B25W25**
 - 2. Each coat to be applied in different color than previous coat.

2.4 PRIMERS/SEALERS

- A. Primer Sealer, Latex, Interior: **MPI #50.**
 - 1. **Sherwin Williams, ProMar 200** Zero VOC Interior Latex Primer, **B28W2600.**
- B. Primer, Alkali Resistant, Water Based: **MPI #3.**
 - 1. **Sherwin Williams, Loxon** Concrete and Masonry Interior/Exterior Primer, **A24W8300**
- C. Primer, Latex, for Interior Wood: **MPI #39.**
 - 1. **Sherwin Williams, PrepRite ProBlock** Latex Primer/Sealer, **B51W620** series.

- D. Wood Knot Sealer: Sealer recommended in writing by topcoat Manufacturer for use in paint systems indicated.

Sherwin Williams, White Shellac.

2.5 METAL PRIMERS

- A. Primer, Rust-Inhibitive, Water Based: **MPI #107.**
 - 1. **Sherwin Williams, Pro Industrial Pro-Cryl** Universal Primer, **B66-310** series.
- B. Primer, Galvanized, Water Based: **MPI #134.**
 - 1. **Sherwin Williams, DTM** Acrylic Primer Finish, **B66W1.**

2.6 WATER BASED PAINTS

- A. Latex, Interior, (Gloss Level 3): **MPI #52.**
 - 1. **Sherwin Williams, ProMar 200** Zero VOC Interior Latex Eg-Shel, **B20W2651** series.
- B. Latex, Interior, High Performance Architectural, (Gloss Level 3): **MPI #139.**
 - 1. **Sherwin Williams, Pro Industrial** Pre-Catalyzed Water based Epoxy Eg-Shel, **K45-150** series.
- C. Latex, Interior, High Performance Architectural, Semi-Gloss (Gloss Level 5): **MPI #141.**
 - 1. **Sherwin Williams, Pro Industrial** Pre-Catalyzed Water based Epoxy Semi-Gloss, **K46-150** series.

2.7 SOURCE QUALITY CONTROL

- A. Testing of Paint Materials: Owner reserves the right to invoke the following procedure:
 - 1. **Owner will engage** the services of a qualified testing agency to sample paint materials. Contractor will be notified in advance and may be present when samples are taken. If paint materials have already been delivered to Project site, samples may be taken at Project site. Samples will be identified, sealed, and certified by testing agency.
 - 2. Testing agency will perform tests for compliance with product requirements.
 - 3. Owner may direct Contractor to stop applying coatings if test results show materials being used do not comply with product requirements. Contractor shall remove non-complying paint materials from Project site, pay for testing, and repaint surfaces painted with rejected materials. Contractor will be required to remove rejected materials from previously painted surfaces if, on repainting with complying materials, the two paints are incompatible.

PART 3 - EXECUTION

3.1 EXAMINATION

- A. Examine substrates and conditions, with Applicator present, for compliance with requirements for maximum moisture content and other conditions affecting performance of the Work.
- B. Maximum Moisture Content of Substrates: When measured with an electronic moisture meter as follows:
 - 1. Concrete: 12 percent.
 - 2. Masonry (CMU): 12 percent.
 - 3. Wood: 15 percent.
 - 4. Gypsum Board: 12 percent.
- C. Gypsum Board Substrates: Verify that finishing compound is sanded smooth.
- D. Verify suitability of substrates, including surface conditions and compatibility with existing finishes and primers.
- E. Proceed with coating application only after unsatisfactory conditions have been corrected.
 - 1. Application of coating indicates acceptance of surfaces and conditions.

3.2 PREPARATION

- A. Comply with Manufacturer's written instructions and recommendations in "MPI Manual" applicable to substrates indicated.
- B. Remove hardware, covers, plates, and similar items already in place that are removable and are not to be painted. If removal is impractical or impossible because of size or weight of item, provide surface-applied protection before surface preparation and painting.
 - 1. After completing painting operations, use workers skilled in the trades involved to reinstall items that were removed. Remove surface-applied protection if any.
- C. Clean substrates of substances that could impair bond of paints, including dust, dirt, oil, grease, and incompatible paints and encapsulants.
 - 1. Remove incompatible primers and re-prime substrate with compatible primers or apply tie coat as required to produce paint systems indicated.
- D. Concrete Substrates: Remove release agents, curing compounds, efflorescence, and chalk. Do not paint surfaces if moisture content or alkalinity of surfaces to be painted exceeds that permitted in Manufacturer's written instructions.
- E. Masonry Substrates: Remove efflorescence and chalk. Do not paint surfaces if moisture content or alkalinity of surfaces or mortar joints exceed that permitted in Manufacturer's written instructions.

- F. Steel Substrates: Remove rust, loose mill scale, and shop primer, if any. Clean using methods recommended in writing by paint Manufacturer but not less than the following:
 - 1. SSPC-SP 3, "Power Tool Cleaning."
- G. Shop Primed Steel Substrates: Clean field welds, bolted connections, and abraded areas of shop paint, and paint exposed areas with the same material as used for shop priming to comply with SSPC-PA 1 for touching up shop-primed surfaces.
- H. Galvanized Metal Substrates: Remove grease and oil residue from galvanized sheet metal fabricated from coil stock by mechanical methods to produce clean, lightly etched surfaces that promote adhesion of subsequently applied paints.
- I. Wood Substrates:
 - 1. Scrape and clean knots, and apply coat of knot sealer before applying primer.
 - 2. Sand surfaces that will be exposed to view, and dust off.
 - 3. Prime edges, ends, faces, undersides, and backsides of wood.
 - 4. After priming, fill holes and imperfections in the finish surfaces with putty or plastic wood filler. Sand smooth when dried.

3.3 APPLICATION

- A. Apply paints according to Manufacturer's written instructions and to recommendations in "MPI Manual."
 - 1. Use applicators and techniques suited for paint and substrate indicated.
 - 2. Paint surfaces behind movable equipment and furniture same as similar exposed surfaces. Before final installation, paint surfaces behind permanently fixed equipment or furniture with prime coat only.
 - 3. Paint front and backsides of access panels, removable or hinged covers, and similar hinged items to match exposed surfaces.
 - 4. Do not paint over labels of independent testing agencies or equipment name, identification, performance rating, or nomenclature plates.
 - 5. Primers specified in painting schedules may be omitted on items that are factory primed or factory finished if acceptable to topcoat Manufacturers.
- B. Tint each undercoat a lighter shade to facilitate identification of each coat if multiple coats of same material are to be applied. Tint undercoats to match color of topcoat, but provide sufficient difference in shade of undercoats to distinguish each separate coat.
- C. If undercoats or other conditions show through topcoat, apply additional coats until cured film has a uniform paint finish, color, and appearance.
- D. Apply paints to produce surface films without cloudiness, spotting, holidays, laps, brush marks, roller tracking, runs, sags, ropiness, or other surface imperfections. Cut in sharp lines and color breaks.

E. Painting Plumbing, HVAC, and Electrical Work:

1. Paint the following work where exposed in equipment rooms:
 - a. Equipment, including panelboards.
 - b. Uninsulated metal piping.
 - c. Uninsulated plastic piping.
 - d. Pipe hangers and supports.
 - e. Metal conduit.
 - f. Metal ductwork.
 - g. Plastic conduit.
 - h. Tanks that do not have factory-applied final finishes.
 - i. Duct, equipment, and pipe insulation having cotton or canvas insulation covering or other paintable jacket material.
 - j. Exposed mechanical equipment or piping as directed by Owner.
2. Paint the following work where exposed in occupied spaces:
 - a. Equipment, including panelboards.
 - b. Uninsulated metal piping.
 - c. Uninsulated plastic piping.
 - d. Pipe hangers and supports.
 - e. Metal conduit.
 - f. Metal ductwork.
 - g. Plastic conduit.
 - h. Duct, equipment, and pipe insulation having cotton or canvas insulation covering or other paintable jacket material.
 - i. Other items as directed by Owner.
 - j. Exposed mechanical equipment or piping as directed by Owner.
3. Paint portions of internal surfaces of metal ducts, without liner, behind air inlets and outlets that are visible from occupied spaces.
4. Paint all exposed metal ductwork, color to be selected by Owner.

3.4 EXPOSED STRUCTURE PAINTING

- A. Contractor to paint all exposed structure (including painting over intumescent coating on structural steel), ductwork, conduit, metal decking, Homasote, and all exposed materials in all Rooms with no ceilings in **Messiah College** standard Sherwin Williams **SW-17W** off white color. Do not paint suspended baffles (or baffle cables and clips) and light fixtures.

3.5 FIELD QUALITY CONTROL

- A. Dry Film Thickness Testing: Owner may engage the services of a qualified testing and inspecting agency to inspect and test paint for dry film thickness.
 1. Contractor shall touch up and restore painted surfaces damaged by testing.

2. If test results show that dry film thickness of applied paint does not comply with paint Manufacturer's written recommendations, Contractor shall pay for testing and apply additional coats as needed to provide dry film thickness that complies with paint Manufacturer's written recommendations.

3.6 CLEANING AND PROTECTION

- A. At end of each workday, remove rubbish, empty cans, rags, and other discarded materials from Project site.
- B. After completing paint application, clean spattered surfaces. Remove spattered paints by washing, scraping, or other methods. Do not scratch or damage adjacent finished surfaces.
- C. Protect work of other trades against damage from paint application. Correct damage to work of other trades by cleaning, repairing, replacing, and refinishing, as approved by Owner, and leave in an undamaged condition.
- D. At completion of construction activities of other trades, touch up and restore damaged or defaced painted surfaces.

3.7 INTERIOR PAINTING SCHEDULE

- A. Concrete Substrates, Non-traffic Surfaces:
 1. Latex System:
 - a. Prime Coat: Primer sealer, latex, interior, **MPI #50**.
 - b. Prime Coat: Latex, interior, matching topcoat.
 - c. Intermediate Coat: Latex, interior, matching topcoat.
 - d. Topcoat: Latex, interior, (Gloss Level 3), **MPI #52**.
 - e. Color and finish level to **be selected by Owner**.
- B. CMU Substrates:
 1. High-Performance Architectural Latex System:
 - a. Block Filler: Block filler, latex, interior/exterior, **MPI #4**.
 - b. Intermediate Coat: Latex, interior, high performance architectural, matching topcoat.
 - c. Topcoat: Latex, interior, high performance architectural, (Gloss Level 3), **MPI #139**.
 - d. Color and finish level to be **selected by Owner**.
- C. Steel Substrates including exposed metal ductwork:
 1. High Performance Architectural Latex System:
 - a. Prime Coat: Primer, Rust Inhibitive Water Based, for metal, **MPI #107**.
 - b. Prime Coat: Shop primer specified in Division 05 Section where substrate is specified.

- c. Intermediate Coat: Latex, interior, high performance architectural, matching topcoat.
 - d. Topcoat: Latex, interior, high performance architectural, semi-gloss (Gloss Level 5), **MPI #141**.
 - e. Color and finish level to be **selected by Owner**.
- D. Galvanized Metal Substrates:
- 1. High Performance Architectural Latex System:
 - a. Prime Coat: Primer, galvanized, water based, **MPI #134**.
 - b. Intermediate Coat: Latex, interior, high performance architectural, matching topcoat.
 - c. Topcoat: Latex, interior, high performance architectural, semi-gloss (Gloss Level 5), **MPI #141**.
 - d. Color and finish level to be **selected by Owner**.
- E. Wood Substrates: Including exposed wood not stained.
- 1. Latex System:
 - a. Prime Coat: Primer, latex, for interior wood, **MPI #39**.
 - b. Intermediate Coat: Latex, interior, matching topcoat.
 - c. Topcoat: Latex, interior, (Gloss Level 3), **MPI #52**.
 - d. Color and finish level to be **selected by Owner**.
- F. Gypsum Board Substrates:
- 1. Latex System:
 - a. Prime Coat: Primer sealer, latex, interior, **MPI #50**.
 - b. Prime Coat: Latex, interior, matching topcoat.
 - c. Intermediate Coat: Latex, interior, matching topcoat.
 - d. Topcoat: Latex, interior, (Gloss Level 3), **MPI #52**.
 - e. Color and finish level to be **selected by Owner**.

** END OF SECTION **

**SECTION 245010
TOILET AND BATH ACCESSORIES**

PART 1 - GENERAL

1.1 SUMMARY

A. Section Includes:

1. Public and Private use washroom accessories.
2. High velocity warm air hand dryers.
3. Under lavatory guards.
4. Custodial accessories.

B. Owner Furnished Material: Owner supplied accessories are listed in Part 2 Products section for each individual accessory.

1. GC is required to install all Owner supplied accessories except for free standing accessories noted as installed by Owner.

1.2 ACTION SUBMITTALS

A. Product Data: For each type of product indicated. Include the following:

1. Construction details and dimensions.
2. Anchoring and mounting requirements, including requirements for cutouts in other work and substrate preparation.
3. Material and finish descriptions.
4. Features that will be included for Project.
5. Manufacturer's warranty.

B. Samples: Full size, for each accessory item to verify design, operation, and finish requirements.

1. Approved full size Samples will be returned and may be used in the Work.

C. Product Schedule: Indicating types, quantities, sizes, and installation locations by room of each accessory required.

1. Identify locations using room designations indicated.
2. Identify products using designations indicated.

1.3 INFORMATIONAL SUBMITTALS

A. Warranty: Sample of special warranty.

1.4 CLOSEOUT SUBMITTALS

- A. Maintenance Data: For toilet and bath accessories to include in maintenance manuals.

1.5 QUALITY ASSURANCE

- A. Source Limitations: For products listed together in the same Part 2 articles, obtain products from single source from single Manufacturer.
- B. Electrical Components, Devices, and Accessories: Listed and labeled as defined in NFPA 70, by a qualified testing agency, and marked for intended location and application.

1.6 COORDINATION

- A. Coordinate accessory locations with other work to prevent interference with clearances required for access by people with disabilities, and for proper installation, adjustment, operation, cleaning, and servicing of accessories.
- B. Deliver inserts and anchoring devices set into concrete or masonry as required to prevent delaying the Work.
- C. Provide fire retardant wood blocking for all accessories not anchored to masonry or concrete.

PART 2 - PRODUCTS

2.1 MATERIALS

- A. Stainless Steel: ASTM A 666, Type 304, 0.031-inch minimum nominal thickness unless otherwise indicated.
- B. Brass: ASTM B 19, flat products; ASTM B 16, rods, shapes, forgings, and flat products with finished edges; or ASTM B 30, castings.
- C. Steel Sheet: ASTM A 1008, Designation CS (cold rolled, commercial steel), 0.036 inch minimum nominal thickness.
- D. Galvanized Steel Sheet: ASTM A 653, with G60 (Z180) hot-dip zinc coating.
- E. Galvanized Steel Mounting Devices: ASTM A 153, hot-dip galvanized after fabrication.
- F. Fasteners: Screws, bolts, and other devices of same material as accessory unit and tamper and theft resistant where exposed, and of galvanized steel where concealed.
- G. Chrome Plating: ASTM B 456, Service Condition Number SC 2 (moderate service).
- H. ABS Plastic: Acrylonitrile butadiene styrene resin formulation.

2.2 PUBLIC AND PRIVATE USE WASHROOM ACCESSORIES

A. Basis-of-Design Products: Subject to compliance with requirements, provide products indicated or comparable products approved by Owner:

B. Grab Bars:

1. Supplied by GC and installed by GC.
2. American Specialties, Inc., 3'-6" Horizontal Grab Bar **AS 3701-42-P** mounted on side wall next to Water Closet.
3. American Specialties, Inc., 1'-6" Vertical Grab Bar **AS 3701-18-P** mounted on side wall next to Water Closet above 3'-6" Grab Bar.
4. American Specialties, Inc., 3'-0" Horizontal Grab Bar **AS 3701-36-P** mounted on back wall behind Water Closet.
5. Mounting: Flanges with concealed fasteners. Mount Grab Bars in accordance with ANSI A117.1 Figures 604.5.1 and 604.5.2.
6. Material: US32D Stainless steel, 0.05 inch thick.
 - a. Finish: Smooth, No. 4 finish (satin) on ends and slip resistant texture in grip area.
7. Outside Diameter: 1-1/2 inches.
8. Configuration and Length: Straight, 36 inches long horizontal, 42 inches long horizontal, and 18 inches long vertical.
9. Locations: As directed by Owner.

C. Mirrors:

1. Supplied by GC and installed by GC.
2. Refer to Division 08 Section 088000 "Glazing" for framed mirror requirements.
3. Size: As indicated on Drawings.
4. Mounting: Mount bottom edge of reflecting surface 40" maximum above floor surface in compliance with ANSI A117.1, Section 603.3.

D. High Velocity Warm Air Hand Dryer:

1. Supplied by GC and installed by GC.
2. Excel Dryer Inc., XLERATOR Model **XL-SB**.
3. Mounting: Surface mounted in compliance with ANSI A117.1.
4. Operation: Electronic auto sensor activated with timed power cut-off switch.



- a. Operation Time: 10 to 15 seconds.

5. Cover Material and Finish: Brushed Stainless steel, No. 4 finish (satin).
6. Size: 11 3/4" W x 12 11/16" H x 6 11/16" D.
7. Weight: 16 pounds.
8. Electrical Requirements: 120 V, 12.5 A, 60Hz, 1500 W. GC to provide power supply in wall as required.

E. Feminine Napkin Vendor:

1. Supplied by Owner and installed by GC.
2. Rochester Midland Corporation **J6-RC** Vendor.
3. Type: Sanitary napkin and tampon.
4. Description: Accessory has windows to easily see when product is empty. All-metal, all-welded construction with rounded corners, silk-screened graphics, and ADA compliant handles.
5. Mounting: Surface mounted in each Women's Restroom in compliance with ANSI A117.1.
6. Capacity: 17 Napkins, 26 Tampons.
7. Size: 10 ¾" W x 31 ¼" H x 5 ½" D.
8. Weight: 17.75 pounds.
9. Operation: Single die-cast coin mechanism (25 cents).
10. Exposed Material and Finish: White enamel factory finish.
11. Lockset: Tumbler type with separate lock and key for coin box

F. Feminine Napkin Disposal:

1. Supplied by GC and installed by GC.
2. Bobrick **B-270** Disposal.
3. Door or Cover: disposal opening cover with piano hinge.
4. Receptacle: Removable.
5. Size: 7 ½" W x 10" H x 3 13/16" D.
6. Material and Finish: Stainless steel, No. 4 finish (satin).
7. Mounting: Surface mounted in every Women's Restroom at Water Closet at 25" to 30" AFF to top of Accessory in compliance with ANSI A117.1.



G. Paper Towel Dispenser:

1. Supplied by Owner and installed by GC.
2. In-Sight Sanitouch **09990** Dispenser.
3. Description: High impact plastic with smoked transparent cover with gray back. Dispenser automatically advances and cuts a nominal 12" of towel when activated by pulling exposed towel with emergency feed knob.
4. Minimum Capacity: One 8 inch wide, 800-foot long roll.
5. Lockset: Tumbler type.
6. Mounting: Surface mounted at 52" AFF to towel pull in compliance with ANSI A117.1.

H. Paper Towel Disposal:

1. Supplied by Owner and installed by Owner (free standing Trash Cans).
2. No installation required.

I. Soap Dispenser for Public Restrooms:

1. Supplied by Owner and installed by GC.
2. Impact Products, Inc., ClearVu Encore **9330** Dispenser.
3. Description: Smooth curved design with large push bar, water resistant top, and removable back plate.
4. Capacity: 30 oz tank.
5. Dispenses: 1 cc per stroke depending on soap viscosity.
6. Size: 6 ¼" H x 4 ½" W x 4" D.

7. Color: White see thru.
8. Refill Indicator: Window type. No key required for re-filling.
9. Mounting: Vertically oriented, surface mounted at each Lavatory location in compliance with ANSI A117.1.

J. Toilet Tissue Holder:

1. Supplied by Owner and installed by GC.
2. In-Sight Coreless JRT **09608** Twin Dispenser.
3. Description: Smoked transparent high impact plastic. Sliding door on bottom prevents usage of one roll until the other roll is depleted. No operating door, no key required, and no disposable core.
4. Minimum Capacity: Two 9.38” diameter x 3.8” wide tissue rolls.
5. Mounting: Surface mounted at 30” AFF to tissue pull at each Water Closet on Toilet Partition in compliance with ANSI A117.1.

K. Facial Tissue Holder:

1. Supplied by Owner and installed by Owner (free standing tissue holders).
2. No installation required.

L. Robe Hooks:

1. Supplied by GC and installed by GC.
2. Franklin Brass **FB 5502SF** Century Collection Double Hook.
3. Material: US32D Stainless steel, smooth No. 4 finish (satin).
4. Mounting: Mount on back of Toilet Partition door facing water Closet when door is in closed position in compliance with ANSI A117.1. Mount two hooks on ADA doors.



2.3 UNDERLAVATORY GUARDS

A. Manufacturers: Subject to compliance with requirements, available Manufacturers offering products that may be incorporated into the Work include, but are not limited to, the following:

1. Plumberex Specialty Products, Inc.
2. Truebro by IPS Corporation.

B. Under Lavatory Guard:

1. Supplied by GC and installed by GC.
2. Insulating pipe covering for supply and drain piping assemblies that prevent direct contact with and burns from piping; allow service access without removing coverings.
3. Material and Finish: Antimicrobial, molded plastic, white.
4. Mounting: Mount on all exposed piping below ADA Accessible Lavatories in all Restrooms in compliance with ANSI A117.1.

2.4 CUSTODIAL ACCESSORIES

- A. Basis-of-Design Products: Subject to compliance with requirements, provide products indicated or comparable products approved by Owner:
- B. Utility Shelf:
1. Supplied by GC and installed by GC.
 2. Description: Exposed edges turned down not less than 1/2 inch and supported by two triangular brackets welded to shelf underside.
 3. Size: 16 inches long by 6 inches deep.
 4. Mounting: Mount one shelf in every Janitor's Room. Location to be determined by Owner.
 5. Material and Finish: Not less than nominal 0.05 inch thick stainless steel, No. 4 finish (satin).
- C. Mop and Broom Holder:
1. Supplied by GC and installed by GC.
 2. Description: Unit with shelf, hooks, holders, and rod suspended beneath shelf.
 3. Length: 36 inches.
 4. Hooks: Three.
 5. Mop / Broom Holders: Four, spring loaded, rubber hat, cam type.
 6. Material and Finish: Stainless steel, No. 4 finish (satin).
 - a. Shelf: Not less than nominal 0.05 inch thick stainless steel, No. 4 finish (satin).
 - b. Rod: Approximately 1/4 inch diameter stainless steel, No. 4 finish (satin).
- D. Paper Towel Dispenser:
1. Supplied by Owner and installed by GC.
 2. In-Sight Sanitouch **09990** Dispenser.
 3. Description: High impact plastic with smoked transparent cover with gray back. Dispenser automatically advances and cuts a nominal 12" of towel when activated by pulling exposed towel with emergency feed knob.
 4. Minimum Capacity: One 8 inch wide, 800-foot long roll.
 5. Lockset: Tumbler type.
 6. Mounting: Surface mounted at 48" AFF to towel pull.
- E. Soap Dispenser:
1. Supplied by Owner and installed by GC.
 2. Impact Products, Inc., ClearVu Encore **9330** Dispenser.
 3. Description: Smooth curved design with large push bar, water resistant top, and removable back plate.
 4. Capacity: 30 oz tank.
 5. Dispenses: 1 cc per stroke depending on soap viscosity.
 6. Size: 6 1/4" H x 4 1/2" W x 4" D.
 7. Color: White see thru.
 8. Refill Indicator: Window type. No key required for re-filling.

2.5 FABRICATION

- A. General: Fabricate units with tight seams and joints, and exposed edges rolled. Hang doors and access panels with full length, continuous hinges. Equip units for concealed anchorage and with corrosion resistant backing plates.
- B. Keys: Provide universal keys for internal access to accessories for servicing and re-supplying. Provide minimum of **six** keys to Owner's representative.

PART 3 - EXECUTION

3.1 INSTALLATION

- A. Install accessories according to Manufacturers' written instructions, using fasteners appropriate to substrate indicated and recommended by unit Manufacturer. Install units level, plumb, and firmly anchored in locations and at heights indicated.
- B. Grab Bars: Install to withstand a downward load of at least 250 lbf, when tested according to ASTM F 446.

3.2 ADJUSTING AND CLEANING

- A. Adjust accessories for unencumbered, smooth operation. Replace damaged or defective items.
- B. Remove temporary labels and protective coatings.
- C. Clean and polish exposed surfaces according to Manufacturer's written recommendations.

**** END OF SECTION ****

**SECTION 245020
FIRE PROTECTION SPECIALTIES**

PART 1 - GENERAL

1.1 SUMMARY

- A. Section Includes:
 - 1. Fire Extinguishers and Cabinets.
 - 2. Accessories.

1.2 REFERENCES

- A. NFPA 10 - Portable Fire Extinguishers

1.3 SUBMITTALS

- A. Submit product data which shall include physical dimensions, operational features, color and finish, anchorage details, rough-in measurements, location, and details.
- B. Submit Manufacturer's installation instructions.

1.4 QUALITY ASSURANCE

- A. National Fire Protection Association (NFPA) Publications:
 - 1. NFPA 10 - Portable Fire Extinguishers
- B. **2009** International Fire Code, Section 906.
- C. Underwriter's Laboratories, Inc. (UL) Standards:
 - 1. UL 4A-60BC classification

1.5 OPERATION AND MAINTENANCE DATA

- A. Do not install extinguishers when ambient temperatures may cause freezing.

PART 2 - PRODUCTS

2.1 ACCEPTABLE MANUFACTURERS

- A. Approved Manufacturers:

1. Larsen's Manufacturing Company (800-527-7367) Basis of Design.
2. J. L. Industries, Inc. (800-554-6077).

2.2 EXTINGUISHERS

- A. Multi-Purpose, Dry-Chemical Type: Steel Tank, pressurized, including hose and nozzle; 10-pound, ABC classification, UL 4A/60BC.
- B. Install extinguishers where shown on the Plans or as required by NFPA 10 and **2009** IFC Section 906 and as approved by AHJ.
- C. Owner has standardized with Amerex brand extinguishers which is the basis of design with no substitutions permitted. Provide Amerex #456, loop part #15363 (Brooks) / #14220 (Amerex) with converted mounting so unit can be hung on #1007 (Amerex) wall cabinet bracket.

2.3 CABINETS

- A. Items specified below are by Larsen's Manufacturing Co. Equivalent products by listed Manufacturer will be acceptable.

1. Fully Recessed Cabinet (FEC-1): "MP10" Extinguisher with Architectural Series "SS2409-R2" fully recessed cabinet for non-rated wall locations and Architectural Series "FSSS2409-R2" fully recessed cabinet for rated wall locations. Cabinets to have vertical Duo Clear Acrylic vertical vision panel with 304 Stainless Steel door with #4 finish. 
2. Rough Opening: 25" high x 10 1/2" wide x 6 1/4" deep for "SS2409-R2" cabinet. 26 1/8" high x 11 5/8" wide x 7 1/8" deep for "FSSS2409-R2" cabinet. GC to provide wall thickness required for each fully recessed cabinet shown on Floor Plans. Provide rated cabinets in all rated wall locations. Refer to Code Sheet for rated wall locations.
3. Mount cabinet with Fire Extinguisher handle 48" AFF with the top of the Fire Extinguisher no more than 60" AFF.

- B. Cabinet: 18 gauge fully recessed steel cabinet with Duo Acrylic vertical vision panel and 304 Stainless Steel door with #4 finish, flat trim type with continuous piano hinge.

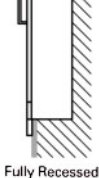
1. Color: Cabinet interior to be factory finished steel with white baked enamel finish. Cabinet exterior door to be 304 Stainless Steel with #4 finish and Duo Clear Acrylic vertical vision panel.
2. Provide factory applied lettering that reads "IN CASE OF FIRE ONLY - PULL FIRMLY ON HANDLE" on cabinet.
3. Maintain rated wall assembly requirements at all rated fire extinguisher cabinet locations. Extend rated wall beyond rated cabinet in each direction as approved by the AHJ. 

- C. Mounting Hardware: Appropriate to Cabinet.

D. Fabrication:

1. Form body of cabinet with tight inside corners and seams.
2. Pre-drill holes for anchorage.
3. Provide one piece stainless steel trim and door construction.
4. Hinge doors for 180 degree opening with continuous piano hinge. Provide pull handle and roller type catch. Handle type to be selected by Owner from Manufacturer's full range of handle types.

2.4 FINISHES

- A. Extinguishers: Red Enamel.
- B. Cabinet: Steel with factory applied white baked enamel finish.
- C. Door: 304 stainless steel with #4 finish.

PART 3 - EXECUTION

3.1 INSPECTION

- A. Verify rough openings for cabinet are correctly sized and located.
- B. Verify rated cabinets installed in rated wall locations.
- C. Beginning of installation means acceptance of existing conditions.

3.2 INSTALLATION

- A. Install cabinets plumb and level in wall openings. Secure rigidly in place in accordance with Manufacturer's instructions.

** END OF SECTION **

SECTION 245030 METAL LOCKERS

PART 1 - GENERAL

1.1 SUMMARY

- A. Included: This Section includes, following:
 - 1. All-Assembled Double Tier lockers.

1.2 PREINSTALLATION MEETINGS

- A. Pre-installation Conference: Conduct conference at Project site.

1.3 ACTION SUBMITTALS

- A. Product Data: For each type of metal locker.
 - 1. Include construction details, material descriptions, dimensions of individual components and profiles, and finishes for each type of metal locker.
- B. Shop Drawings: For metal lockers.
 - 1. Include plans, elevations, sections, details, and attachments to other work.
 - 2. Show locker trim and accessories.
 - 3. Include locker identification system and numbering sequence.
- C. Samples for Initial Selection: Manufacturer's color charts showing the full range of colors available.
- D. Samples for Verification: For the following products, in Manufacturer's standard size:
 - 1. Lockers and equipment.

1.4 INFORMATIONAL SUBMITTALS

- A. Qualification Data: For Installer.
- B. Sample Warranty: For special warranty.

1.5 CLOSEOUT SUBMITTALS

- A. Maintenance Data: For adjusting, repairing, and replacing locker doors and latching mechanisms to include in maintenance manuals.

1.6 MAINTENANCE MATERIAL SUBMITTALS

- A. Furnish extra materials that match products installed and that are packaged with protective covering for storage and identified with labels describing contents.
 - 1. Full-size units of the following metal locker hardware items equal to 10 percent of amount installed for each type and finish installed, but no fewer than five units:
 - a. Locks.
 - b. Identification plates.
 - c. Hooks.

1.7 DELIVERY, STORAGE, AND HANDLING

- A. Do not deliver metal lockers until spaces to receive them are clean, dry, and ready for their installation.
- B. Deliver master and control keys, combination control charts to Owner by registered mail or overnight package service, addressed as follows:
 - 1. **Kathie Shafer**
Vice President for Operations
Messiah College
P.O. Box 3035
One College Avenue
Mechanicsburg, PA 17055

1.8 FIELD CONDITIONS

- A. Field Measurements: Verify actual dimensions of recessed openings by field measurements before fabrication.

1.9 COORDINATION

- A. Coordinate sizes, locations and concrete bases for metal lockers.
- B. Coordinate sizes and locations of framing, blocking, furring, reinforcements, and other related units of work specified in other Sections to ensure that metal lockers can be supported and installed as required.

1.10 WARRANTY

- A. Special Warranty: Manufacturer agrees to repair or replace components of metal lockers that fail in materials or workmanship, excluding finish, within specified warranty period.
 - 1. Failures include, but are not limited to, the following:
 - a. Structural failures.

- b. Faulty operation of latches and other door hardware.
2. Damage from deliberate destruction and vandalism is excluded.
3. Warranty Period for Welded Metal Lockers: Lifetime from date of Substantial Completion.

1.11 PERFORMANCE REQUIREMENTS

- A. Performance: Work shall meet most stringent requirements for design, dimensions, performance, details, construction, accessibility and installation required by codes and regulations of public authorities having jurisdiction over the Work including, but not limited to, ADA and ANSI A117.1 for accessibility and usability for physically handicapped people.
- B. Surface Burning Characteristics: Work shall have flame spread rating and smoke developed rating meeting requirements of public authorities having jurisdiction over the Work.
- C. Accessibility: In accordance with IBC 1109.8.1, provide a minimum of 5% of the lockers to be handicap accessible or a total of **3** units minimum. Accessible unit locations to be approved by the Owner.

PART 2 - PRODUCTS

2.1 MATERIALS

- A. Steel Sheet - General: ASTM A1008, cold-rolled and leveled steel for doors and door frames. Cold-rolled steel or annealed, specially treated steel for other parts. Steel shall be free from buckle, scale and surface imperfections.
- B. Fasteners: Corrosion resistant fasteners standard of Manufacturer. Exposed bolt heads shall be slotless type. Provide self-locking nuts or lock washers for nuts on moving parts, or otherwise prevent loosening of nuts.
- C. Equipment: Furnish hooks and hang rods of cadmium or zinc coated steel or cast aluminum.
- D. Source Limitations: Obtain metal lockers, locker benches, and accessories from single source from single locker Manufacturer.
 1. Obtain locks from single lock Manufacturer.

2.2 LOCKERS

- A. Products: Subject to compliance with requirements, provide products by one of the following:
 1. Lyon Workspace Products, LLC; Heavy Duty.
 2. Penco Products, Inc; Guardian Plus.
 3. Republic Storage Systems Company; Heavy Duty.
 4. Salsbury Industries; Heavy Duty.

- B. All Assembled Construction: Fabricate metal lockers for pre-assembly at Manufacturer's facility using factory welds. Factory weld frame members together to form a rigid, one-piece assembly.
- C. No legs.
- D. Heavy Duty Body:
 - 1. Body: 24 gauge steel and double flanged connections extending full height.
 - 2. Door Frame: 16 gauge formed steel channels. Vertical members to have an additional flange to form continuous door strike. Corners to be lapped and welded into rigid assembly. Bottom cross members to have tang at each end that fits through slot in rear flange of upright frame member to prevent twisting out of alignment.
 - 3. Recessed Trim: End and top recess trim for lockers to be placed in wall recesses to be 18 gauge formed steel with 2 3/4" wide face to be bolted to lockers.
 - 4. Top: 16 gauge sloping formed steel in minimum 5'-0" lengths attached to top of lockers in line with concealed fasteners approved by the Manufacturer.
- E. Double Tier Locker Ventilation: Six 6" louvers top and bottom.
- F. Heavy Duty Door:
 - 1. Sheet Steel: One-piece 16 gauge steel with hinge side formed into channel shaped formation with other three sides flanged at 90 degree angle. Fabricate to swing 180 degrees.
 - 2. Reinforcing: Provide extra bracing or reinforcing on inside of doors over 15 inches wide.
 - 3. Hinges: Heavy duty, full loop, five knuckle, tight pin, 2 inches high minimum. Weld to inside of frame and secured to door with concealed and tamperproof fasteners.
 - 4. Coat Hooks: One double prong hook and three single prong wall hooks, 5/8" diameter, zinc plated.
 - 5. Number Plates: Aluminum number plates with etched figures, 3/8" high. All lockers to have number plate attached near the top of the door. Number sequence to be determined by Owner.
 - 6. Handle and Latch:
 - a. Recessed Handle and Latch: Recessed housing of one-piece stainless steel with staple and eye for padlock, and with required latching action as follows:
 - 1) Double Tier Lockers: Two point minimum latching for each door.
 - b. Accessible Handle and Latch: Provide ADA designated locker units with ADA compliant lever handle with chromium plated finish or recessed housing of one-piece stainless steel. Latching shall have ADA compliant action and activation not requiring tight grasping, pinching, or twisting of the wrist and that operates with maximum 5 pound force; shall be heavy duty, positive automatic, prelocking vandal proof and pry resistant mechanism with staple and eye for padlock, and with latching as required. Provide synthetic rubber silencers secured in frame at each latch point.
 - 1) Double Tier Lockers: Two point minimum latching for each door.

7. Locking - Padlock: Provide handle and latch mechanism with staple and eye for padlock.
 8. Anchoring: Wall anchoring to cmu with expansion type anchors approved by the Manufacturer. Floor anchoring to concrete base with anchor type approved by the Manufacturer.
- G. Accessible Lockers: Lockers shall meet applicable requirements of this Section, except lockers shall be configured for disabled people. Accessible configuration shall include:
1. General: lower opening of a double tier locker.
 2. Bottom: Locker bottom shall be 15 inches minimum off floor for forward reach units and 15 inches minimum off floor for parallel reach units.
 3. Handle: ADA compliant handle and latch.
 4. Symbol: Lockers indicated for disabled people shall have accessibility symbol affixed to door.

2.3 ACCESSORIES

- A. Concrete Base: Continuous 4" concrete base for full length of lockers and for full recess of lockers.
- B. Sloping Tops: Continuous 16 gauge steel at approximately 25 degrees pitch; Full length of locker opening in cmu recess.
- C. Filler Panels: 16 gauge steel sheet for closure to adjacent construction or surfaces or other like conditions, factory fabricated, of, with concealed fasteners. Filler panels to close cmu recess entirely. No gaps in cmu recess will be permitted.

2.4 FINISH

- A. Baked Enamel Finish: Thermal cured enamel coating system, standard of Manufacturer.
- B. Color: Color as **selected by Owner** from standard colors.

PART 3 -

PART 4 - EXECUTION

4.1 EXAMINATION

- A. Examine walls, floors, and support concrete bases, with Installer present, for compliance with requirements for installation tolerances and other conditions affecting performance of the Work.
- B. Prepare written report, endorsed by Installer, listing conditions detrimental to performance of the Work.
- C. Proceed with installation only after unsatisfactory conditions have been corrected.

4.2 INSTALLATION

- A. General: Install lockers level, plumb, and true; shim as required, using concealed shims.
- B. Fasteners: Install lockers with concealed fasteners.
- C. Locker Anchorage: Anchor lockers to supporting construction at 36 inches maximum centers, except as otherwise instructed and recommended by Manufacturer. Install anchors through back-up reinforcing plates where necessary to avoid metal distortion.
- D. Accessories: Install concrete bases, sloping tops and other accessories to provide a flush, hairline joint against adjacent surfaces.
 - 1. Attach hooks with at least two fasteners.
 - 2. Attach door locks on doors using security-type fasteners.
 - 3. Identification Plates: Identify metal lockers with identification selected by Owner.
 - a. Attach plates to each locker door, near top, centered, with at least two aluminum rivets.

4.3 ADJUSTING

- A. Clean, lubricate, and adjust hardware. Adjust doors and latches to operate easily without binding. Verify that integral locking devices operate properly.

4.4 PROTECTION

- A. Protect metal lockers from damage, abuse, dust, dirt, stain, or paint. Do not permit use during construction.
- B. Touch up marred finishes, or replace metal lockers that cannot be restored to factory-finished appearance. Use only materials and procedures recommended or furnished by locker Manufacturer.

** END OF SECTION **

SECTION 245040
HORIZONTAL LOUVER BLINDS

PART 1 - GENERAL

1.1 SUMMARY

- A. Section Includes:
 - 1. Horizontal louver blinds with aluminum slats.

1.2 ACTION SUBMITTALS

- A. Product Data: For each type of product.
- B. Shop Drawings: Show fabrication and installation details for horizontal louver blinds.
- C. Samples: For each exposed product and for each color and texture specified, 12 inches long.
- D. Samples for Verification: For each type and color of horizontal louver blind indicated.
 - 1. Horizontal Louver Blind: Full-size unit, 32 inches wide by 36 inches long.

1.3 INFORMATIONAL SUBMITTALS

- A. Product Certificates: For each type of horizontal louver blind.
- B. Product Test Reports: For each type of horizontal louver blind, for tests performed by manufacturer and witnessed by a qualified testing agency.

1.4 CLOSEOUT SUBMITTALS

- A. Maintenance Data: For horizontal louver blinds to include in maintenance manuals.

1.5 MAINTENANCE MATERIAL SUBMITTALS

- A. Furnish extra materials that match products installed and that are packaged with protective covering for storage and identified with labels describing contents.
 - 1. Horizontal Louver Blinds: Full-size units equal to 5 percent of quantity installed but no fewer than two units.

1.6 QUALITY ASSURANCE

- A. Mockups: Build mockups to verify selections made under Sample submittals and to demonstrate aesthetic effects and set quality standards for fabrication and installation.
 - 1. Subject to compliance with requirements, approved mockups may become part of the completed Work if undisturbed at time of Substantial Completion.

1.7 DELIVERY, STORAGE, AND HANDLING

- A. Deliver horizontal louver blinds in factory packages, marked with manufacturer, product name, and location of installation.

1.8 FIELD CONDITIONS

- A. Environmental Limitations: Do not install horizontal louver blinds until construction and wet and finish work in spaces, including painting, is complete and dry and ambient temperature and humidity conditions are maintained at the levels indicated for Project when occupied for its intended use.
- B. Field Measurements: Where horizontal louver blinds are indicated to fit to other construction, verify dimensions of other construction by field measurements before fabrication and indicate measurements on Shop Drawings. Allow clearances for operating hardware of operable glazed units through entire operating range. Notify Owner of installation conditions that vary from Drawings. Coordinate fabrication schedule with construction progress to avoid delaying the Work.

PART 2 - PRODUCTS

2.1 MANUFACTURERS

- A. Source Limitations: Obtain horizontal louver blinds from single source from single manufacturer.

2.2 HORIZONTAL LOUVER BLINDS, ALUMINUM SLATS

- A. Manufacturers: Subject to compliance with requirements, available manufacturers offering products that may be incorporated into the Work include, but are not limited to, the following:
 - 1. Hunter Douglas Contract.
 - 2. Levolor Contract; a Newell Rubbermaid company.
- B. Slats: Aluminum; alloy and temper recommended by producer for type of use and finish indicated; with crowned profile and radius corners.
 - 1. Width: 2 inches.

2. Thickness: Manufacturer's standard, not less than 0.008 inch.
 3. Spacing: Manufacturer's standard.
 4. Finish: Ionized antistatic, dust-repellent, baked polyester finish.
 5. Features:
 - a. Lift-Cord Rout Holes: Minimum size required for lift cord and located near back (outside) edge of slat to maximize slat overlap and minimize light gaps between slats.
- C. Headrail: Extruded aluminum; long edges returned or rolled. Headrails fully enclose operating mechanisms on three sides.
1. Capacity: One blind per headrail unless otherwise indicated.
 2. Ends: Manufacturer's standard, capped or plugged.
 3. Manual Lift Mechanism:
 - a. Lift-Cord Lock: Variable; stops lift cord at user-selected position within blind full operating range.
 - b. Operator: Extension of lift cord(s) through lift-cord lock mechanism to form cord pull.
 4. Manual Tilt Mechanism: Enclosed worm-gear mechanism and linkage rod that adjusts ladders.
 - a. Tilt: Full.
 - b. Operator: Clear-plastic wand.
 - c. Over-Rotation Protection: Manufacturer's detachable operator or slip clutch to prevent over rotation of gear.
 5. Manual Lift-Operator and Tilt-Operator Lengths: Full length of blind when blind is fully closed.
 6. Manual Lift-Operator and Tilt-Operator Locations: Right side of headrail unless otherwise indicated, or otherwise selected by Owner.
- D. Bottom Rail: Extruded-aluminum tube that secures and protects ends of ladders and lift cords and has plastic- or metal-capped ends.
1. Type: Top contoured to match crowned shape of slat.
- E. Lift Cords: Manufacturer's standard braided cord.
- F. Ladders: Evenly spaced across headrail at spacing that prevents long-term slat sag.
1. Type: Braided cord.
- G. Mounting Brackets: With spacers and shims required for blind placement and alignment indicated.
1. Type: Overhead.
 2. Intermediate Support: Provide intermediate support brackets to produce support spacing recommended by blind manufacturer for weight and size of blind.

- H. Hold-Down Brackets and Hooks or Pins: Manufacturer's standard.
- I. Side Channels and Perimeter Light Gap Seals: Manufacturer's standard.
- J. Colors, Textures, Patterns, and Gloss:
 - 1. Slats: **As selected by Owner** from manufacturer's full range.
 - 2. Components: Provide rails, cords, ladders, and materials exposed to view matching or coordinating with slat color.

2.3 HORIZONTAL LOUVER BLIND FABRICATION

- A. Product Safety Standard: Fabricate horizontal louver blinds to comply with WCMA A 100.1 including requirements for corded, flexible, looped devices; lead content of components; and warning labels.
- B. Unit Sizes: Fabricate units in sizes to fill window and other openings as follows, measured at 74 deg F:
 - 1. Outside of Jamb Installation: Width and length as indicated, with terminations between blinds of end-to-end installations at centerlines of mullion or other defined vertical separations between openings.
- C. Concealed Components: Noncorrodible or corrosion-resistant-coated materials.
 - 1. Lift-and-Tilt Mechanisms: With permanently lubricated moving parts.
- D. Mounting and Intermediate Brackets: Designed for removal and reinstallation of blind without damaging blind and adjacent surfaces, for supporting blind components, and for bracket positions and blind placement indicated.
- E. Installation Fasteners: No fewer than two fasteners per bracket, fabricated from metal noncorrosive to brackets and adjoining construction; type designed for securing to supporting substrate; and supporting blinds and accessories under conditions of normal use.
- F. Color-Coated Finish:
 - 1. Metal: For components exposed to view, apply manufacturer's standard baked finish complying with manufacturer's written instructions for surface preparation including pretreatment, application, baking, and minimum dry film thickness.

PART 3 - EXECUTION

3.1 EXAMINATION

- A. Examine substrates, areas, and conditions, with Installer present, for compliance with requirements for installation tolerances, operational clearances, and other conditions affecting performance.
 - 1. Proceed with installation only after unsatisfactory conditions have been corrected.

3.2 INSTALLATION

- A. Install horizontal louver blinds level and plumb, aligned and centered on openings, and aligned with adjacent units according to manufacturer's written instructions.
 - 1. Locate so exterior slat edges are not closer than 2 inches from interior faces of glass and not closer than 1/2 inch from interior faces of glazing frames through full operating ranges of blinds.
 - 2. Install mounting and intermediate brackets to prevent deflection of headrails.
 - 3. Install with clearances that prevent interference with adjacent blinds, adjacent construction, and operating hardware of glazed openings, other window treatments, and similar building components and furnishings.

3.3 ADJUSTING

- A. Adjust horizontal louver blinds to operate free of binding or malfunction through full operating ranges.

3.4 CLEANING AND PROTECTION

- A. Clean horizontal louver blind surfaces after installation according to manufacturer's written instructions.
- B. Provide final protection and maintain conditions in a manner acceptable to manufacturer and Installer and that ensures that horizontal louver blinds are without damage or deterioration at time of Substantial Completion.
- C. Replace damaged horizontal louver blinds that cannot be repaired in a manner approved by Owner before time of Substantial Completion.

3.5 DEMONSTRATION

- A. Engage a factory-authorized service representative to train Owner's maintenance personnel to adjust, operate, and maintain systems.

** END OF SECTION **

The MechoShade® Manual Drive System

Mecho/5

Mecho/5, MechoShade's latest patented design featuring an overrunning clutch, self lubricating components and larger diameter sprocket, providing 67% more lift capacity. As a result, Mecho/5 increases the shade size range that a manual drive system can lift before motorization is required. Plus, the Mecho/5 carries a Lifetime* Limited Warranty on the hardware and shadecloth.

Mecho/5 requires no adjustments, resulting in faster, easier installation. Mecho/5 has been field tested and performance proven on hundreds of thousands of shades installed worldwide. Available in Standard, PocketExtended, Extended and DoubleShade' bracket sizes.

The Mecho/5 can accommodate shades up to 126" (320cm) wide by 180" (457cm) high.

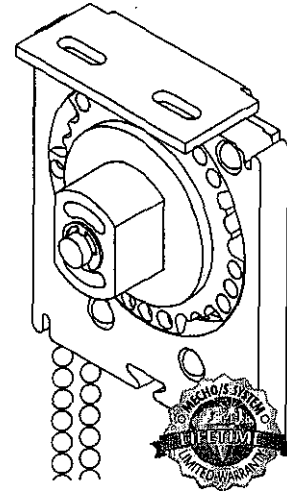

MechoID Slimline™

Slimline™ is MechoShade's compact heavy-duty bracket system designed for small shades in narrow spaces, uses the MechoID/3 operating system and carries a 10-Year Limited Warranty* on the hardware and shadecloth.

MechoShade' brackets are available in a variety of sizes:

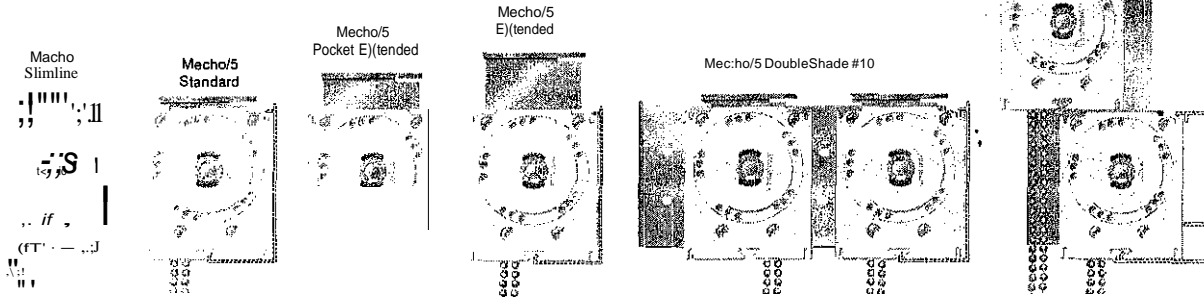

Bracket Type	Max. Roll Diameter With Fascia	Max. Roll Diameter Without Fascia	Bracket Dimensions Without Optional Fascia, Roll Up Diameter or Wall Mount Bracket
Mecho ^{III} SlimLine™	2-11/4" (57mm)	2-3/4" (?Omm)	2-3/8" (60mm) W x 3-3/4" (95mm) H
Mecho ^{III} /5 Standard	2-3/4" (70mm)	2-3/4" (?Omm)	3" (76mm) W x 3-3/4" (95mm) H
Mecho/5 Pocket Extended	N/A	4" (102mm)	3" (76mm) W x 4-3/8" (111mm) H
Mecho/5 Extended	3-7/16" (87mm)	5" (127mm)	2-3/4" (70mm) W x 4-7/8" (124mm) H
Mecho ^{III} /5 DoubleShades ^{III}			
#10 Rear shade Blackout	2-3/4" (70mm)	2-3/4" (70mm)	7-1/2" (191mm) W x 3-3/4" (95mm) H
#10 Front shade Sunscreen	2-3/4" (70mm)	2-3/4" (70mm)	
#15 Top shade Blackout	2-3/4" (70mm)	-3-3/8" (86mm)	2-3/4" (70mm) W x 7-5/16" (194mm) H
#15 Bottom shade SunScreen	2-3/4" (70mm)	4-5/16" (110mm)	

*Mecho/5 Lifetime Limited Warranty: for the life of the interior project, not to exceed 25 years. See pages 2.26 - 2.28 for specific details.

† See pages 2.26 - 2.28 for details.

MechoShade Systems, Inc.

42-03 35th Street, Long Island City, NY 11101

Telephone: 718-729-2020

Fax: 718-729-2941 1800-899-8081

E-mail: irm@mechoshadesystems.com
Internet Vi

Ray & Sons, inc. System JDS.
Sbadinl
Coverings
The Competitive Window Treatment
Since 1911 instown, PA 19401
56 Buttonwood Street • Fax #: (610) 277-2721
Phone t: (610) 277-2720 •



MechoShade® Parts, Components and Optional Accessories

Multiband MechoShade® exploded view and edge clearances

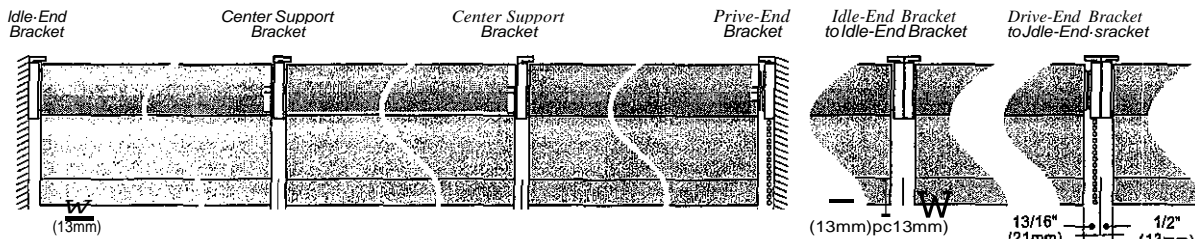
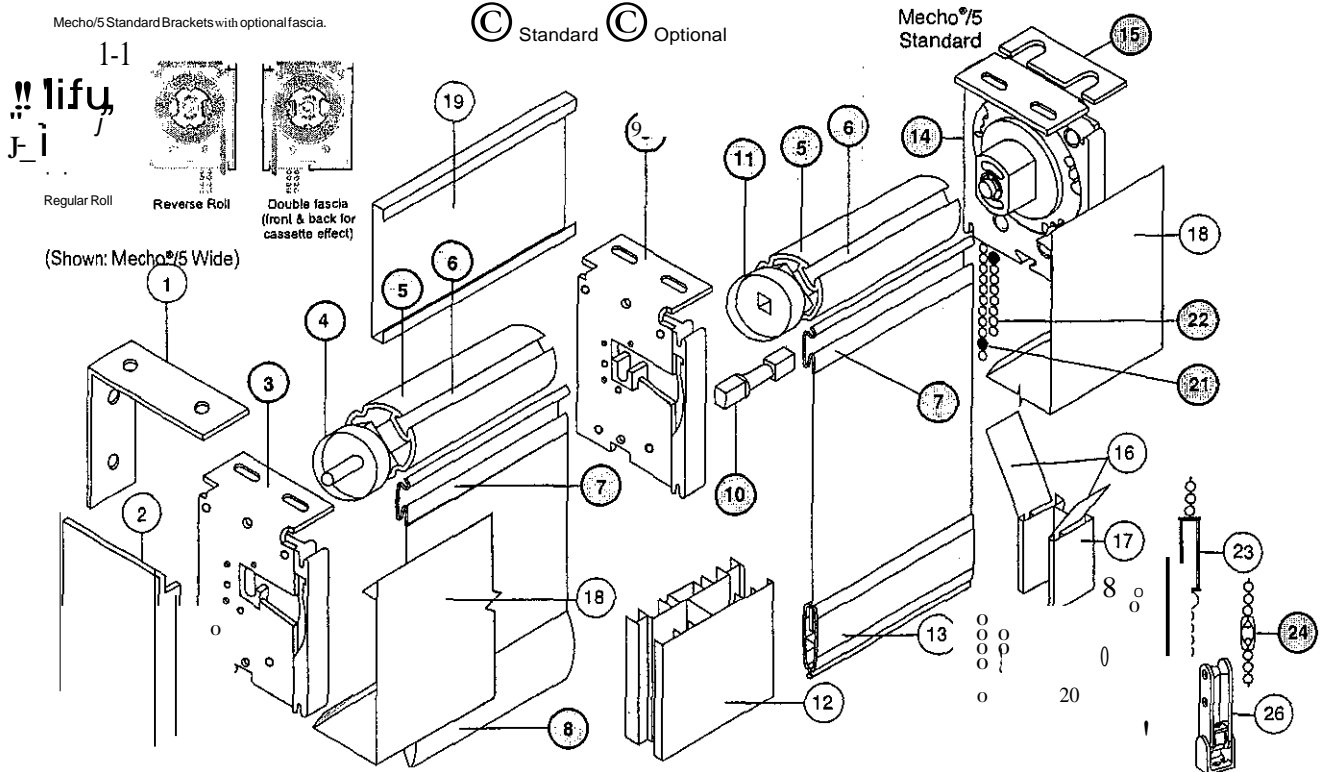

Edge clearances 1/8" (3mm). Shown: A Mecho/5 3-banded shade, right-hand drive, regular roll, no fascia. Mecho Slimline is the same except the Drive-End clearance is 1 1/16" (17.5mm)

MechoShades are available in a choice of two drive systems in multiple bracket sizes.

19. Tube Plug (Be: 1te1 3opp61£r'

20. Heavy Duty Bumper

21. Upper and Lower Bead Chain Stops

22. Drive Chain (stainless-steel bead chain)

23. Bead Chain Connector

24. Aluminum Accessory Finishes: Clear Anodized, White, Grey, Black, Quaker Bronze (Ouranodic color) and Colonial White (fascia only)

25. Child-Safe Chain Retainers included for all residential and public facilities.

26. Optional Regular-Roll Fascia available for: Mecho/S Standard and Extended brackets and Mecho Slimline brackets.

Optional Reverse-Roll Fascia available for: Mecho/5 Standard brackets. •No Fascia Available: Mecho/5 Pocket brackets.

For Edge Clearances of specific brackets see the last section of this binder.

MechoShade Systems, Inc.

42-03 35th Street, Long Island City, NY 11101

Telephone: 718-729-2541 • 800-899-8081

E-mail: info@InternetWe

Kay & Sons, inc.

The Competitive Advantage in Shading Systems, Window Treatments & Wall Coverings

Since 1922

56 Buttonwood Street • Norristown, PA 19401

Phone #: (610) 277-2720 • Fax #: (610) 277-2721

MechoShade® Details

Mecho® Slimline™ Bracket

Maximum roll up diameter:
 2-1/4" (57mm) with optional fascia,
 2-3/4" (70mm) without fascia.

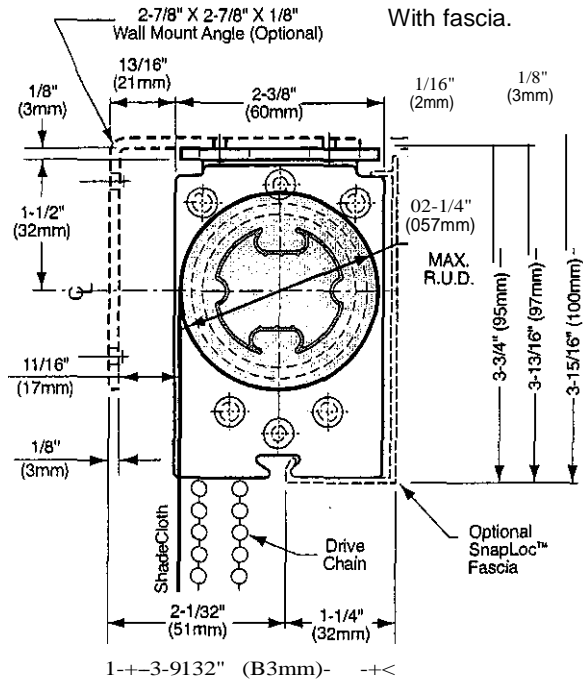

Mecho®/5 Standard Bracket

Maximum roll up diameter:
 2-3/4" (70mm) with or without optional fascia.

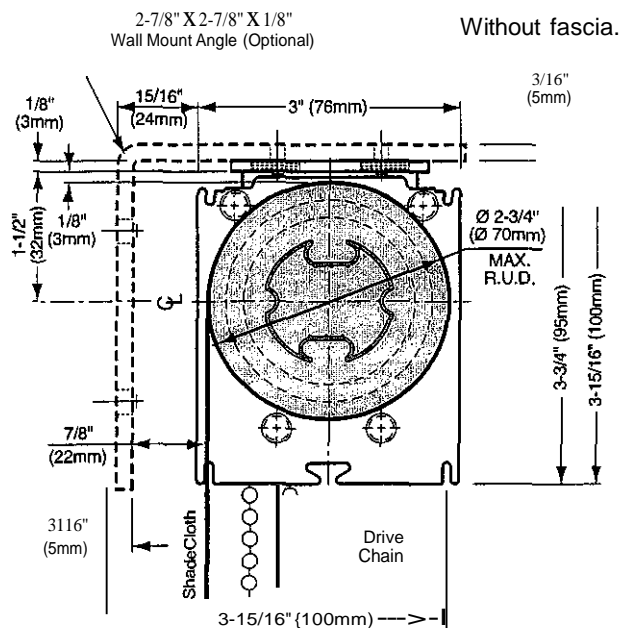
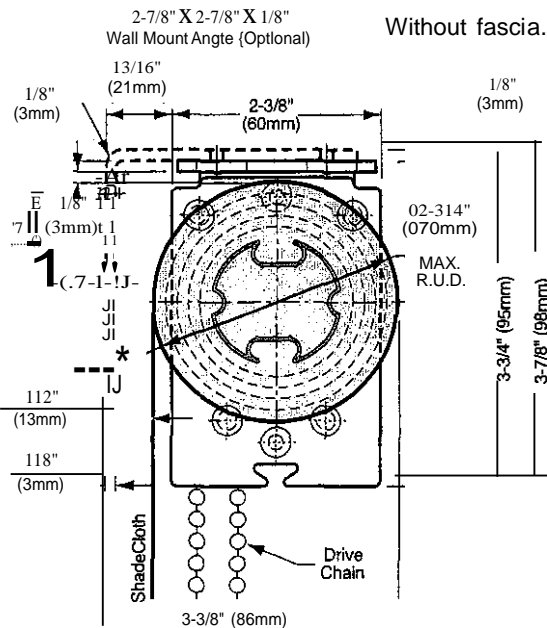
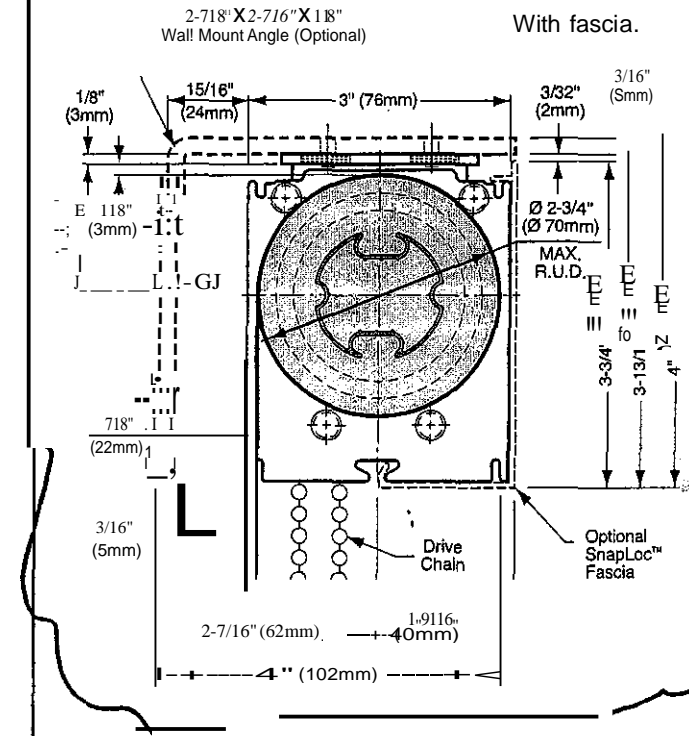

See the MechoShade® Bracket Selection Guide on pages 2.7 - 2.11.

MechoShade Systems, Inc.
 42-03 35th Street, Long Island City, NY 11101
 Telephone: 718-729-2020
 Fax: 718-729-2941 1800-899-8081

E-mail: info@
 Internet Wet

Kay & Sons, inc.
 The Competitive Advantage in Shading Systems,
 Window Treatments & Wall Coverings
 Since 1922

56 Buttonwood Street • Norristown, PA 19401
 Phone #: (610) 277-2720 • Fax #: (610) 277-2721

Other MechoShade® Components & Optional Accessories

Guide Cables are used when shades are sloped or the width to height ratio (1:6) needs assistance in keeping the shade tracking correctly.

1" (25mm) diameter aluminum Hemtube sealed inside the shadecloth with Gulde Cable Finials.

1" x 1-1/4" x 112" (25mm x 32mm x 13mm) Aluminum Mounting Block (Mill Finish)

SHOWN: OPTIONAL SIAPLOC™ FASCIA MOUNTED TO STANDARD BRACKET REGULAR ROLL

SHOWN: OPTIONAL SIAPLOC™ FASCIA MOUNTED TO DOUBLES HADE BRACKET REGULAR ROLL

Ik.

FASCIA FOR SLIMLINE
REGULAR ROLL
MFAA SL15 AL

FASCIA FOR STANDARD BRACKETS
BRACKETS REGULAR ROLL
MFAA RG15 AL

FASCIA FOR STANDARD
REVERSE ROLL
MFAARR15 AL

FASCIA FOR EXTENDED BRACKETS
UFAA 4715 AL

FASCIA FOR DOUBLESHADE #15
REGULAR ROLL
UFAA 7321 AL

SLIMLINE FASCIA END CAPS (PAIRS)
MFAA2336 AL

MECHO5 OR 3 WIDE FASCIA END CAPS (PAIRS)
MFAA 3036 AL

MECHO5 OR 3 EXTENDED FASCIA END CAPS (PAIRS)
MFAA 3346 AL

MECHO DOUBLESHADES #15 FASCIA ENO CAPS (PAIRS)
MFAA 3170 AL

SINGLE WALL-MOUNT ANGLE
5" K5" x 1-1/4" (127 x 127 x 32mm)
FOR EXTENDED & DOUBLESHADE #15 BRACKETS
UWBX 5050 ST PL

SINGLE WALL-MOUNT ANGLE
4" x 4" x 1-1/4" (102 x 102 x 32mm)
FOR SLIMLINE, WIDE, POCKET & EXTENDED BRACKETS
EWBX 4040 ST ZP

DOUBLE WALL-MOUNT ANGLE
4" x 4" x 3" (102 x 102 x 76mm)
FOR SLIMLINE, WIDE, POCKET & EXTENDED BRACKETS
EWBX4145 ST ZP

SINGLE WALL-MOUNT ANGLE
FOR SLIMLINE, WIDE, POCKET
MWBX 2727 ST ZP

Back-to-Back Brackets

1" (25.40mm) Between Brackets

MechoShade Systems, Inc.
42-03 35th Street, Long Island City, NY 11101
Telephone: 718-729-2020
Fax: 718-729-2941 1800-899-8081

E-mail: info@m1
Internet Web Site

Kay & Sons, inc.
The Competitive Advantage in Shading Systems
Window Treatments & Wall Coverings
Since 1922
66 Buttonwood Street • Norristown, PA 19401
Phone #: (610) 277-2720 • Fax #: (610) 277-2721

MechoShade® Hardware Features and Specifications

MECH05

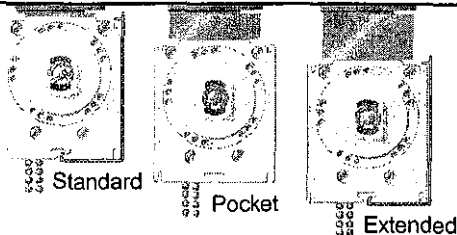

4. Mounting Plates

The drive assembly, idle-end assembly, and center support systems are attached to an 1/8 in. (3mm) steel universal mounting bracket.

2. No Adjustment Necessary
Mecho®/5 drive-end bracket requires no adjustment, resulting in faster installations.

3. Overrunning Clutch Design
An overrunning clutch design that disengages to 90° during the raising and lowering of the shade and can withstand a pull force of 40 lbs. (18 kg). Recommended maximum lift shade-band 20 lbs. (9 kg).

4. Braking Surface

The patented self-lubricating oil impregnated steel hub, on which the brake system is mounted, includes an articulated brake assembly which assures smooth, non-jerky operation in raising and lowering the shades.

5. Sprocket

A one-piece molded Delrin® chain sprocket.

6. Hardware

All hardware is available with a universal offset drive and left-hand or right-hand operations. The offset-drive chain assembly places both operating chains at the same location or to the rear of the shade cloth out of sight. The distance between the center line of the operating chain shall not exceed 1/2 in. (13mm).

7. Tube Support

A Delrin® cover plate provides protection from the tube being dislocated. In the event the tube should be pushed out of

place, the Delrin end

of the mounting plates contains the tube which may prevent the tube from falling out of the bracket.

8. Wide Spans

Depending on the height, weight and shade cloth specified, MechoShades can be made up to 12 feet wide or more. Call your local representative or MechoShade Systems technical support.

9. Interchange or replacement

Bracket components can be interchanged or replaced without having to remove the brackets from the walls or ceilings. This feature is included in both inside and outside mountings.

10. Component Quality

Plastic components are made of strong, dimensionally stable DuPont Delrin®. Not ABS/polystyrene or nylon.

11. Bracket Metal

Support brackets are plated 1/8 in. (3mm) steel. Custom colors are available on special order.

12. Narrow-Edge Clearances

Drive-end: 13/16 in. (21mm), idle-end: 1/2 in. (13mm), and center support 5/16 in. (8mm).

• Multiple Operators

A single drive bracket can handle two or more shade bands permitting a single operator to operate the shade, assuring simultaneous alignment of all the bands (within MSS recommended weight limits).

14. Faceted Window Installations

The offset drive permits up to a 12-degree (6°+6°) angle between any two shades with a single operator. By special

order only, up to six shades each side maximum. Contact MechoShade Systems, Inc. for details.

15. Optional SnapLoc Fascia
Snaploc® fascia shall be provided for standard and extended height brackets and center support brackets. Each bracket assembly permits the fascia to extend past the brackets, creating wall-to-wall fascia, with the brackets mounted inboard from the end of the fascia. Snaploc fascia can be installed as a single unit over two or more shade band assemblies without exposed joints in lengths up to 15ft. (457cm). Snaploc fascia snaps on to the brackets without the use of glue, magnetic strips or any exposed fastening.

The fascia is made of extruded aluminum (hardness/alloy 6063T5) with an average thickness of .062 in. (1.6mm). The fascia is finished in PPG Ouracon™ baked enamel in six standard colors plus clear aluminum.

16. Offset Chain, No-Notch Fascia

The operating chain drops behind the return edge of the fascia without the necessity of notching or otherwise defacing the return leg of the fascia. The MechoShade® Wide, and Extended brackets accommodate fascia returns no less than 1-1/2 in. (38mm) (50%) from the front of the hardware fully concealing the roll and tube.

17. Shade Mounting

The Snaploc® spline permits positive Snaploc mounting and demounting of the shade cloth from the tube without having to remove the hardware, the tube or brackets and without the use of two-sided tape, staples or other fasteners.

Continued < iW

The Competitive Advantage in Shading Systems

42-0335111 Street, Long Island City, NY 11101
Telephone: 718-729-2020

E-mail: info

56 Buttonwood Street • Norristown PA 19401

Window Treatments & Wall Coverings
Since 1922
Phone #: (610) 277-2720 • Fax #: (610) 277-2721

© Copyright 2004, MaehnShade Systems, Inc., Long Island City, NY. Mae/lo, MerlmShada and Snaploe are registered trademarks DIM "*****", ,g,..... "v--
their respective companies. Specifications subject to change without notice.

emarks of

MechoShade® Hardware Features and Specifications

18. Non-Binding Regressed End Plug

The idle-end plug is fitted with a recess which prevents oversized tubes from being forced between brackets. This arrangement assures proper sizing and clearance between the tube and the brackets and minimizes light leaks.

19. End Brackets

Consist of 1/8 in. (3mm) thick sheet steel. Wall, jamb or ceiling mounted as required and permanently installed.

20. Center Support Brackets

For ceiling or wall mounted multibanded shades. Center support brackets shall accept continuous lengths of fascia, which will span two or more MechoShade bands. Minimum length 15ft. (457cm).

21. Aluminum Bars

Mill-finished aluminum bars in single lengths as appropriate for the size shade, concealed in a fabric hem pocket.

22. Painted and Baked PPG Finishes

In painted and baked PPG finishes with key way for shades.

23. DualShade System

The patented DualShade system; by MechoShade Systems, Inc., for installing both a ThermoVeil® sun screen together with either a room darkening shade cloth or MirroFilm™ attached to the same roller tube by means of the Snaploc spline. The shade cloth and film shall be separated by 1/2 in. (13mm) of insulating air space.

24. DoubleShades®

A master mounting bracket assembly for drive-end, idle-end and center

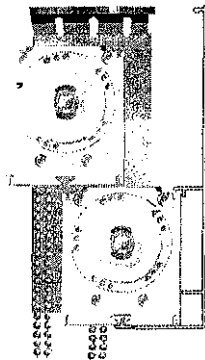

MECHO® SLIMLINE

SLIMLINE™ is available in the Mecho/3 design and shares the features of the Mecho/5 except on the following:

1. Mounting Brackets

At 2-3/8 in. (60mm) W X 3-3/4 in. (95mm) H, the drive-end, idle-end and center supports become the smallest heavy-duty system available.

2. Variable Adjustment

Adjustments can be made in the static mode (free-falling adjustment) or in the dynamic mode (infinite-stop adjustment).

3.

A linear disc brake, as opposed to a flat-steel backing plate, consists of a compression spring with two friction-absorbing nylon washers on a 1/4 in. (6mm) steel shaft. This design provides continuous uniform compensating brake pressure on the one-piece



sprocket-brake drive component. The compression spring also acts as a vibration absorber.

3.1. Shake-Proof

A shake-proof steel and nylon vibration resistant lining nut is employed to maintain the desired braking friction. On the desired brake force is applied, the adjustment nut will not require readjustment when slippage of the adjustment nut from vibration and weakening of the braking surfaces occurs. The concealed brake-tension adjustment is not accessible to unauthorized personnel.

4. Braking Surface

The linear disc-brake system utilizes a minimum of 2.89 sq. in. braking surface.

12. Narrow-Flange Clearances

Drive-end: 1/16 in. (1.7mm), idle-end: 1/2 in. (13mm), and center support: 5/16 in. (8mm).

25. Warranty

Failure of any part or component shall be replaced at no charge, subject to warranty conditions. The drive chain is a fail safe component that is designed to break in two at 60-90 lbs. (27-41 kg) of shock and is not covered by the warranty. The chain may be quickly repaired or spliced on site by maintenance personnel in minutes. (Contact MechoShade Systems for warranty terms and conditions.)

alignment and minimum installation labor. DoubleShade® brackets have all the same features of the standard Mecho/5 bracket, plus allow both sun screen and blackout shades on a single bracket. DoubleShade's compact size allow two shades to fit in a smaller room projection than two individually installed shades on the same window.

25. Warranty

Failure of any part or component shall be replaced at no charge, subject to warranty conditions. The drive chain is a fail safe component that is designed to break in two at 60-90 lbs. (27-41 kg) of shock and is not covered by the warranty. The chain may be quickly repaired or spliced on site by maintenance personnel in minutes. (Contact MechoShade Systems for warranty terms and conditions.)

Ka" & Sons, inc.

The Competitive Advan... in Shading Systems, Wall Coverings Window Treatment... Since 1922
 1000 Street, Norristown, PA 19401
 Phone: (610) 277-2200 Fax: (610) 277-2721

MechoShade Systems, Inc.
 42-03 35th Street, Long Island City, NY 11101

Telephone: 718-729-2020
 Fax: 718-729-2941 1800-899-8081

E-mail: info@mech
 Internet Web Site: www.mech.com

**SECTION 245060
PLASTIC-LAMINATE-CLAD COUNTERTOPS**

PART 1 - GENERAL

1.1 SUMMARY

- A. Section includes plastic-laminate countertops.

1.2 ACTION SUBMITTALS

- A. Product Data: For each type of product, including panel products, high-pressure decorative laminate, adhesive for bonding plastic laminate and fire-retardant-treated materials.
 - 1. Include data for fire-retardant treatment from chemical-treatment manufacturer and certification by treating plant that treated materials comply with requirements.
- B. Shop Drawings: Show location of each item, dimensioned plans and elevations, large-scale details, attachment devices, and other components.
 - 1. Show locations and sizes of cutouts and holes for plumbing fixtures, faucets, soap dispensers, and other items installed in plastic-laminate countertops.
 - 2. Apply AWI Quality Certification Program label to Shop Drawings.
- C. Samples for Verification:
 - 1. Plastic laminates, **12 by 12 inches**, for each type, color, pattern, and surface finish, with one sample applied to core material and specified edge material applied to one edge.
 - 2. Wood-grain plastic laminates, **24 by 24 inches**, for each type, pattern and surface finish, with one sample applied to core material and specified edge material applied to one edge.

1.3 INFORMATIONAL SUBMITTALS

- A. Qualification Data: For Installer and fabricator.
- B. Product Certificates: For the following:
 - 1. Composite wood and agrifiber products.
 - 2. High-pressure decorative laminate.
 - 3. Chemical-resistant, high-pressure decorative laminate.
 - 4. Adhesives.
- C. Woodwork Quality Standard Compliance Certificates: AWI Quality Certification Program certificates.
- D. Evaluation Reports: For fire-retardant-treated materials, from ICC-ES.

1.4 QUALITY ASSURANCE

- A. Fabricator Qualifications: Shop that employs skilled workers who custom fabricate products similar to those required for this Project and whose products have a record of successful in-service performance. Shop is a certified participant in AWI's Quality Certification Program.
- B. Installer Qualifications: Fabricator of products and certified participant in AWI's Quality Certification Program.
- C. Testing Agency Qualifications: For testing agency providing classification marking for fire-retardant-treated material, an inspection agency acceptable to authorities having jurisdiction that periodically performs inspections to verify that the material bearing the classification marking is representative of the material tested.

1.5 DELIVERY, STORAGE, AND HANDLING

- A. Do not deliver countertops until painting and similar operations that could damage countertops have been completed in installation areas. If countertops must be stored in other than installation areas, store only in areas where environmental conditions comply with requirements.

1.6 FIELD CONDITIONS

- A. Environmental Limitations: Do not deliver or install countertops until building is enclosed, wet work is complete, and HVAC system is operating and maintaining temperature between **60 and 90 deg F** and relative humidity between 43 and 70 percent during the remainder of the construction period.
- B. Field Measurements: Where countertops are indicated to fit to other construction, verify dimensions of other construction by field measurements before fabrication, and indicate measurements on Shop Drawings. Coordinate fabrication schedule with construction progress to avoid delaying the Work.
- C. Established Dimensions: Where countertops are indicated to fit to other construction, establish dimensions for areas where countertops are to fit. Provide allowance for trimming at site, and coordinate construction to ensure that actual dimensions correspond to established dimensions.

PART 2 - PRODUCTS

2.1 PLASTIC-LAMINATE COUNTERTOPS

- A. Quality Standard: Unless otherwise indicated, comply with the "Architectural Woodwork Standards" for grades indicated for construction, installation, and other requirements.
 - 1. Provide labels and certificates from AWI certification program indicating that countertops, including installation, comply with requirements of grades specified.

2. The Contract Documents contain selections chosen from options in the quality standard and additional requirements beyond those of the quality standard. Comply with those selections and requirements in addition to the quality standard.
- B. Grade: Premium.
- C. High-Pressure Decorative Laminate: NEMA LD 3, Grade HGS.
1. Manufacturers: Subject to compliance with requirements, available manufacturers offering products that may be incorporated into the Work include, but are not limited to, the following:
 - a. Formica Corporation.
 - b. Lamin-Art, Inc.
 - c. Nevamar Decorative Surfaces.
 - d. Panolam Industries International, Inc.
 - e. Wilsonart International; Div. of Premark International, Inc.
- D. Chemical-Resistant, High-Pressure Decorative Laminate: NEMA LD 3, Grade HGP, and as follows:
1. Laminate has the following ratings when tested with indicated reagents according to NEMA LD 3, Test Procedure 3.9.5:
 - a. Nitric Acid (30 Percent): Moderate effect.
 - b. Sulfuric Acid (77 Percent): Moderate effect.
 - c. Hydrochloric Acid (37 Percent): Moderate effect.
 - d. Phosphoric Acid (75 Percent): No effect.
 - e. Acetic Acid (98 Percent): No effect.
 - f. Formaldehyde: No effect.
 - g. Ethyl Acetate: No effect.
 - h. Ethyl Ether: No effect.
 - i. Phenol (85 Percent): Moderate effect.
 - j. Benzene: No effect.
 - k. Xylene: No effect.
 - l. Butyl Alcohol: No effect.
 - m. Furfural: No effect.
 - n. Methyl Ethyl Ketone: No effect.
 - o. Sodium Hydroxide (25 Percent): No effect.
 - p. Sodium Sulfide (15 Percent): No effect.
 - q. Ammonium Hydroxide (28 Percent): No effect.
 - r. Zinc Chloride: No effect.
 - s. Gentian Violet: No effect.
 - t. Methyl Red: No effect.
 2. Products: Subject to compliance with requirements, available products that may be incorporated into the Work include, but are not limited to, the following:
 - a. Formica Corporation; Lab Grade 840 Black.
 - b. Panolam Industries International, Inc.; Pionite Chemguard.
 - c. Wilsonart International, Div. of Premark International, Inc.; Chemsurf.

- E. Colors, Patterns, and Finishes: Provide materials and products that result in colors and textures of exposed laminate surfaces complying with the following requirements:
1. As **selected by Owner** from manufacturer's full range in the following categories:
 - a. Solid colors, matte finish.
 - b. Solid colors with core same color as surface, matte finish.
 - c. Wood grains, matte finish.
 - d. Patterns, matte finish.
 2. Grain Direction: Parallel to cabinet fronts.
- F. Edge Treatment: Same as laminate cladding on horizontal surfaces.
- G. Core Material: Particleboard.
- H. Core Material at Sinks: Particleboard made with exterior glue.
- I. Core Thickness: **3/4 inch**.
1. Build up countertop thickness to **1-1/2 inches** at front, back, and ends with additional layers of core material laminated to top.
- J. Backer Sheet: Provide plastic-laminate backer sheet, NEMA LD 3, Grade BKL, on underside of countertop substrate.
- K. Paper Backing: Provide paper backing on underside of countertop substrate.

2.2 FIRE-RETARDANT-TREATED MATERIALS

- A. Fire-Retardant Particleboard: Panels complying with the following requirements, made from softwood particles and fire-retardant chemicals mixed together at time of panel manufacture to achieve flame-spread index of 25 or less and smoke-developed index of 25 or less per ASTM E 84.
1. For panels **3/4 inch** thick and less, comply with ANSI A208.1 for Grade M-2 except for the following minimum properties: modulus of rupture, **1600 psi**; modulus of elasticity, **300,000 psi**; internal bond, **80 psi**; and screw-holding capacity on face and edge, **250 and 225 lbf**, respectively.
 2. Products: Subject to compliance with requirements, available products that may be incorporated into the Work include, but are not limited to, the following:
 - a. Flakeboard Company Limited; Duraflake FR.
 - b. SierraPine; Encore FR.

2.3 ACCESSORIES

- A. Grommets for Cable Passage through Countertops: **1-1/4-inch** OD, brown, molded-plastic grommets and matching plastic caps with slot for wire passage.

1. Product: Subject to compliance with requirements, provide "SG series" by Doug Mockett & Company, Inc.

2.4 MISCELLANEOUS MATERIALS

- A. Adhesives: Do not use adhesives that contain urea formaldehyde.
- B. Adhesives: Use adhesives that meet the testing and product requirements of the California Department of Health Services' "Standard Practice for the Testing of Volatile Organic Emissions from Various Sources Using Small-Scale Environmental Chambers."
- C. Adhesive for Bonding Plastic Laminate: Unpigmented contact cement.
 1. Adhesive for Bonding Edges: Hot-melt adhesive or adhesive specified above for faces.
- D. VOC Limits for Installation Adhesives and Sealants: Use products that comply with the following limits for VOC content when calculated according to 40 CFR 59, Subpart D (EPA Method 24):
 1. Wood Glues: 30 g/L.
 2. Multipurpose Construction Adhesives: 70 g/L.
 3. Structural Wood Member Adhesive: 140 g/L.
 4. Architectural Sealants: 250 g/L.

2.5 FABRICATION

- A. Sand fire-retardant-treated wood lightly to remove raised grain on exposed surfaces before fabrication.
- B. Fabricate countertops to dimensions, profiles, and details indicated. Provide front and end overhang of **1 inch** over base cabinets.
- C. Complete fabrication, including assembly, to maximum extent possible before shipment to Project site. Disassemble components only as necessary for shipment and installation. Where necessary for fitting at site, provide ample allowance for scribing, trimming, and fitting.
 1. Notify Owner seven days in advance of the dates and times woodwork fabrication will be complete.
 2. Trial fit assemblies at fabrication shop that cannot be shipped completely assembled. Install dowels, screws, bolted connectors, and other fastening devices that can be removed after trial fitting. Verify that various parts fit as intended and check measurements of assemblies against field measurements before disassembling for shipment.
- D. Shop cut openings to maximum extent possible to receive appliances, plumbing fixtures, electrical work, and similar items. Locate openings accurately and use templates or roughing-in diagrams to produce accurately sized and shaped openings. Sand edges of cutouts to remove splinters and burrs.
 1. Seal edges of openings in countertops with a coat of varnish.

PART 3 - EXECUTION

3.1 PREPARATION

- A. Before installation, condition countertops to average prevailing humidity conditions in installation areas.
- B. Before installing countertops, examine shop-fabricated work for completion and complete work as required, including removal of packing and backpriming.

3.2 INSTALLATION

- A. Grade: Install countertops to comply with same grade as item to be installed.
- B. Assemble countertops and complete fabrication at Project site to the extent that it was not completed in the shop.
 - 1. Provide cutouts for appliances, plumbing fixtures, electrical work, and similar items.
 - 2. Seal edges of cutouts by saturating with varnish.
- C. Field Jointing: Where possible, make in the same manner as shop jointing, using dowels, splines, adhesives, and fasteners recommended by manufacturer. Prepare edges to be joined in shop so Project-site processing of top and edge surfaces is not required. Locate field joints where shown on Shop Drawings.
 - 1. Secure field joints in plastic-laminate countertops with concealed clamping devices located within **6 inches** of front and back edges and at intervals not exceeding **24 inches**. Tighten according to manufacturer's written instructions to exert a constant, heavy-clamping pressure at joints.
- D. Install countertops level, plumb, true, and straight. Shim as required with concealed shims. Install level and plumb to a tolerance of **1/8 inch in 96 inches**.
- E. Scribe and cut countertops to fit adjoining work, refinish cut surfaces, and repair damaged finish at cuts.
- F. Fire-Retardant-Treated Wood: Handle, store, and install fire-retardant-treated wood to comply with chemical treatment manufacturer's written instructions, including those for adhesives used to install woodwork.
- G. Countertops: Anchor securely by screwing through corner blocks of base cabinets or other supports into underside of countertop.
 - 1. Install countertops with no more than **1/8 inch in 96-inch** sag, bow, or other variation from a straight line.
 - 2. Secure backsplashes to tops with concealed metal brackets at **16 inches** o.c. and to walls with adhesive.
 - 3. Seal junctures of tops, splashes, and walls with mildew-resistant silicone sealant or another permanently elastic sealing compound recommended by countertop material manufacturer.

3.3 ADJUSTING AND CLEANING

- A. Repair damaged and defective countertops, where possible, to eliminate functional and visual defects; where not possible to repair, replace woodwork. Adjust joinery for uniform appearance.
- B. Clean countertops on exposed and semiexposed surfaces. Touch up shop-applied finishes to restore damaged or soiled areas.

** END OF SECTION **

SECTION 245070

SIMULATED STONE COUNTERTOPS

PART 1 - GENERAL

1.1 SUMMARY

A. Section Includes:

1. Quartz agglomerate countertops and backsplashes.

1.2 ACTION SUBMITTALS

A. Product Data: For countertop materials.

B. Shop Drawings: For countertops. Show materials, finishes, edge and backsplash profiles, methods of joining, and cutouts for plumbing fixtures.

C. Samples for Verification: For the following products:

1. Countertop material, 6 inches square.

1.3 PROJECT CONDITIONS

A. Field Measurements: Verify dimensions of countertops by field measurements after base cabinets are installed but before countertop fabrication is complete.

1.4 COORDINATION

A. Coordinate locations of utilities that will penetrate countertops or backsplashes.

PART 2 - PRODUCTS

2.1 QUARTZ AGGLOMERATE COUNTERTOPS

A. Configuration: Provide countertops with the following front and backsplash style:

1. Front: Straight, slightly eased at top.
2. Backsplash: Straight, slightly eased at corner.
3. Endsplash: Matching backsplash.

B. Countertops: 3/4-inch- thick, quartz agglomerate with front edge built up with same material.

C. Backsplashes: 1/2-inch- thick, quartz agglomerate.

- D. Fabrication: Fabricate tops in one piece with shop-applied edges unless otherwise indicated. Comply with quartz agglomerate manufacturer's written instructions for adhesives, sealers, fabrication, and finishing.

- 1. Fabricate with loose backsplashes for field assembly.

2.2 COUNTERTOP MATERIALS

- A. Particleboard: ANSI A208.1, Grade M-2.
- B. Adhesives: Adhesives shall not contain urea formaldehyde.
- C. Adhesives: Adhesives shall comply with the testing and product requirements of the California Department of Health Services' "Standard Practice for the Testing of Volatile Organic Emissions from Various Sources Using Small-Scale Environmental Chambers."
- D. Quartz Agglomerate: Solid sheets consisting of quartz aggregates bound together with a matrix of filled plastic resin and complying with the "Physical Characteristics of Materials" Article of ANSI SS1.
 - 1. Manufacturers: Subject to compliance with requirements, available manufacturers offering products that may be incorporated into the Work include, but are not limited to, the following:
 - a. Cambria.
 - b. Cosentino USA.
 - c. E. I. du Pont de Nemours and Company.
 - d. LG Chemical, Ltd.
 - e. Meganite Inc.
 - f. Samsung Chemical USA, Inc.
 - g. Technistone USA, Inc.
 - h. Transolid, Inc.
 - 2. Colors and Patterns: As **selected by Owner** from manufacturer's full range.

PART 3 - EXECUTION

3.1 INSTALLATION

- A. Install countertops level to a tolerance of **1/8 inch in 8 feet**.
- B. Fasten countertops by screwing through corner blocks of base units into underside of countertop. Pre-drill holes for screws as recommended by manufacturer. Align adjacent surfaces and, using adhesive in color to match countertop, form seams to comply with manufacturer's written instructions. Carefully dress joints smooth, remove surface scratches, and clean entire surface.
 - 1. Install backsplashes and endsplashes to comply with manufacturer's written instructions for adhesives, sealers, fabrication, and finishing.

2. Seal edges of cutouts in particleboard subtops by saturating with varnish.

**** END OF SECTION ****

2000 SERIES DATA SHEET



TYPE	AAMA RATING & TEST SIZE	AR (cfm/ft ² @ 50 mph)	WATER (pcf)	DESIGN PRESSURE (psf)	STRUCTURAL OVERLOAD (psf)	U-VALUE (BTU/h ² /ft ² /°F)	CTF	STC	OTC
SINGLE HUNG SIDE LOAD	AW-PG55 60 x 99	0.20	11.07	60.15	90.23	0.40 - 0.61	55	32 - 37	27 - 29
	AW-PG45 60 x 99	0.20	10.03	45.11	67.67	0.40 - 0.61	55	32 - 37	27 - 29
	HHC45 60 x 99	0.07	10.03	45.11	67.67	0.40 - 0.61	55	32 - 37	27 - 29

¹U-values will vary depending upon glazing selected

2000 SERIES QUICK VIEW:

A versatile single hung window. Radius tops and arches available. Historic and institutional applications. Easily removed sash with take-out clips to prevent unauthorized sash removal. Flange Frame.

STANDARD FEATURES

- Block & tackle balances for superior operation
- Mulls to 3 1/4" frame fixed and operable products
- Sash easily removes from frame for maintenance & cleaning
- Removable take-out clips to prevent unauthorized sash removal
- Full-length extruded lift handles
- Auto-sill locks

OPTIONAL FEATURES

- True muntins
- Applied-profile muntin grids
- Class 5 balance to 120 lb. sash
- 2" and extended-flange frame
- Integral transom
- Impost for double window utilizing continuous head and sill
- White bronze lock at meeting rail
- Sloped exterior optional
- Custom nail fins for commercial new construction
- Blast-resistant (B2000) model available
- Historic Bevel (2000H) model available

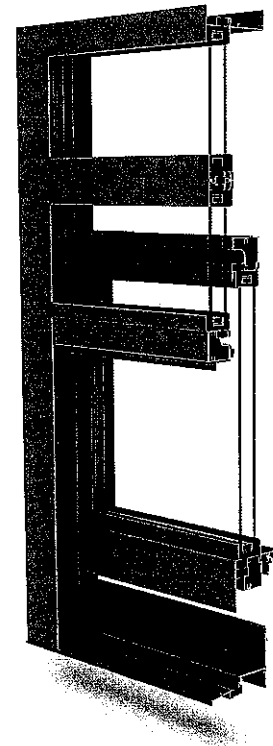

Window series: 2000 Single Hung — General Specifications & Details

- Nominal Frame/Sill Wall Thickness: 0.062/0.094"
- Applications: Industrial, Educational, Hospitals, and Historic
- Mulls to operable and fixed units with 3 1/4" and 4" frame depths
- Max. Test size: 5'0" x 8'3"
- Glazing: Single lite to 1/4"; insulating to 1" (2000 model) & 3/4" (2000H model); bead glazed
- Muntins: Grids between lites of IG unit or exterior-applied or true divided sash options
- Curved Shapes: Radius tops and arches available with mull fixed units
- Maximum Sash Weight: Optional 120 lbs. with larger jamb sightline

- Finish Options:
 - AAMA 2603 — Standard acrylic or polyester
 - AAMA 2604 — 2 coat 50% fluoropolymer
 - AAMA 2605 — 2 coat fluoropolymer 70% kynar
 - Powder Coat
 - Anodized
- Hardware:
 - Spring-loaded latch at sill
- Accessories:
 - Frame Family: 3 1/4"
 - Fixed Lite Option System: 1200
 - Mullions:
 - Stacking: Integral & fixed-stack mull
 - Side: 3-piece-mull
 - Panning: Available
 - Trims: Available
 - Receptor Systems: Available
 - Screen: Security/vandal screen available
- Exceptions: Call Graham sales rep or see website for more information.

Our products are tested to the standards of and certified by the American Architectural Manufacturer's Association and the National Fenestration Rating Council.



SECTION 260010
EXTERIOR BUILDING ID SIGNAGE

GENERAL

Cast aluminum letters with a satin finish, Roffe font.

**SECTION 280010
SITE CLEARING AND CONSTRUCTION LAYOUT**

PART 1 - GENERAL

1.1 SUMMARY

- A. This Section includes the following:
 - 1. Protection of existing trees indicated to remain.
 - 2. Removal of trees and other vegetation indicated to be removed.
 - 3. Stripping and stockpiling of topsoil.
 - 4. Clearing and grubbing.
 - 5. Removing above and below-grade improvements.
 - 6. Layout of required site improvements.
 - 7. Protection of existing underground and overhead utilities, structures and improvements to remain.

- B. Related Sections:
 - 1. Section 280030 “Erosion and Sedimentation Control” for ESC requirements and regulatory compliance.
 - 2. Section 280020 “Earthwork”.

1.2 SUBMITTALS

- A. Surveyor Qualifications.

- B. Permits for Disposal of Debris.
 - 1. Arrange for off-site recycling and/or disposal of debris resulting from clearing and grubbing in accordance with all applicable local, state and federal regulations. Obtain written agreements with each recycling facility, property owner or disposal facility releasing the Owner from responsibility in connection with the recycling and/or disposal of debris.
 - 2. Submit two (2) copies of the agreements with each property owner; recycling and disposal facility.

- C. Test Pit Data: Top and bottom elevations and horizontal location of underground obstructions to be located by a test pit.

1.3 QUALITY ASSURANCE

- A. Land Surveyor Qualifications: A Professional Land Surveyor who is registered in Pennsylvania and who is experienced in providing land-surveying services of the kind indicated.
- B. Pre-Installation Conference: Conduct a meeting between the Prime/General Contractor, Sub-Contractors, Owner and the Design Professional to review the scope of work in this section, coordination with other work, special project conditions and quality standards. Notify all parties and schedule the meeting a minimum of two (2) weeks prior to the anticipated start of the work specified under this Section.

1.4 PROJECT CONDITIONS

- A. Site Information: Prior to beginning construction investigate existing underground utility locations, research available utility records and dig test pits to the extent necessary to verify existing utility depths and locations and to verify that storm drainage and utility systems piping, excavation, filling and grading may be installed in compliance with original design and referenced standards. If the original design is in conflict with the existing utilities, notify the Design Professional of such conflict immediately.
- B. Burning is not permitted on site.
- C. Traffic: Conduct site-clearing operations to ensure minimum interference with roads, streets, walks, and other adjacent occupied or used facilities. Do not close or obstruct streets, walks, or other occupied or used facilities without permission from the Owner and authorities having jurisdiction.
- D. Control dust caused by the work. Dampen surfaces as required. Comply with pollution control regulations of governing authorities.
- E. Protect existing improvements on site and adjacent to the site from damage caused by site work operations. Repair damages at no additional cost to the Owner.
- F. Protection of Existing Improvements: Provide protections necessary to prevent damage to existing improvements indicated to remain in place.
 - 1. Protect improvements on adjoining properties and on Owner's property.
 - 2. Restore damaged improvements to their original condition, as acceptable to property owners.
- G. Protection of Existing Trees and Vegetation: Protect existing trees and other vegetation indicated to remain in place against unnecessary cutting, breaking or skinning of roots, skinning or bruising of bark, smothering of trees by stockpiling materials within drip line, excess foot or vehicular traffic, or parking of vehicles within drip line.
 - 1. General: Review all trees within contract limit line that may be saved with the Design Professional. Do not remove trees designated to remain without written consent of the Design Professional.
 - 2. Equipment Operation and Storage: Do not permit heavy equipment, vehicular traffic, or stockpiles of any construction material (including soil) within the drip line of any tree to be retained. Do not fell trees to be removed into trees being

retained. Do not use trees to be retained for cleaning off excavator buckets by slamming against them.

3. Storage and Disposal of Toxic Materials: Do not store toxic material closer than 100 feet to the drip line of any trees to be retained. Toxic materials include but are not limited to: paint, cement and concrete waste, acid, gypsum board, nails, wire, chemicals, fuels and lubricants.
4. Fencing: Instruct all trades present on site to honor protective devices.
5. Water trees and other vegetation to remain within limits of contract work as required maintaining their health during course of construction operations.
6. Provide protection for roots over one and one-half inch (1 - ½") in diameter that are cut during construction operations. Coat cut faces with emulsified asphalt or other acceptable coating formulated to use on damaged plant tissues. Temporarily cover exposed roots with wet burlap to prevent roots from drying out; cover with earth as soon as possible.
7. Repair or replace trees and vegetation indicated to remain that are damaged by construction operations in a manner acceptable to the Design Professional. Employ a licensed arborist to repair damage to trees and shrubs.
8. Replace trees that cannot be repaired and restored to full-growth status, as determined by the arborist.

H. Relocation of Existing Trees: Move trees under the supervision of an experienced landscape contractor.

1. Do not dig or re-plant trees between July 1st and August 31st.
2. Verify proposed locations for trees to be transplanted.
3. Excavate pits to receive trees prior to removal from existing locations. Provide excavations one and one-half (1 ½) times as wide as standard ball size for size of tree to be transplanted. Minimum ball size shall be eighty (80) inches diameter and minimum of three (3) feet deep.
4. Carefully remove trees from existing locations by mechanical tree spade or manually ball and burlap for transplanting. Do not crack or break ball.
5. Tree spade must be equipped with hydraulic levelers for setting tree level/plumb. Prior to filling tree must be flush with proposed finish grade and level. Adjust position of tree by handling the rootball only – do not push or pull trunk of tree.
6. If trees are moved in full leaf, spray with anti-desiccant prior to moving and again two (2) weeks after transplanting.
7. Carefully place tree(s) in prepared pit. Backfill and water in accordance with Specification Section 285010, Exterior Plants.
8. Stake and guy trees in accordance with Section 285010.

I. Temporary Transplanting of Existing Vegetation:

1. Do not dig or re-plant trees between July 1st and August 31st.
2. If plant material is not immediately transplanted to permanent locations, move to an approved temporary storage area on-site or off-site. Heel in material in accordance with standard practices of the industry. Provide water for a temporary irrigation system.
3. Massed group of salvaged plants in one area as close as practicable for maintenance, security and protection from damage.
4. Do not crack or break ball.

5. Maintain plants in storage area by bracing plants in vertical position and setting balls in an enclosed berm of topsoil or bark mulch. Water trees as needed to maintain a plant in a vigorous condition.
 6. Prune excess growth from crown to reduce transpiration.
- J. Salvable Improvements: Carefully remove items indicated to be salvaged and store on Owner's premises where indicated or directed.

1.5 EXISTING UTILITY SERVICES

- A. Existing utilities and equipment: The existence and location of underground and other utilities indicated as existing are not guaranteed. Before beginning site work, investigate and verify the existence and location of public and private underground and overhead utilities and other construction.
1. Prior to construction, verify the location and invert elevation at points of connection of sanitary sewer, storm sewer and water service piping.
 2. Perform test pits at locations indicated and report utility conflicts prior to ordering structures and pipe materials.
- B. Prior to any excavation or filling activities, contact PA One-Call System (1-800-242-1776) to notify utility companies to field verify underground utility locations within the contract limit work areas. Provide adequate means of protection of utilities and services designated to remain. Should damage occur, repair at no additional cost to Owner.
- C. Arrange for disconnecting, sealing or capping all utilities and services designated to be removed before start of site work operations. Perform all work in accordance with the requirements of the applicable utility company or agency involved.
- D. When uncharted or incorrectly charted underground piping or other utilities and services are encountered during the site work operations, notify the Design Professional, the Owner, and the applicable utility company immediately to obtain procedure directions. Cooperate with the applicable utility company in maintaining active services in operation.
- E. Protect and maintain utility poles and services, curb boxes, valves and other services where required to maintain facilities and services in operation during construction work.
- F. Place markers to indicate location of disconnected services. Identify service lines and capping locations on Project Record Documents.

PART 2 - PRODUCTS

2.1 EROSION CONTROL

- A. Refer to Section 280030 Erosion and Sedimentation Control for specifications of silt fence and erosion control mats.

2.2 PROTECTIVE FENCING

- A. Plastic Fencing – 48-inch high orange polyethylene web fencing secured to conventional steel “T” or “U” posts driven into the ground.
- B. Portable Chain link fence – Minimum 2-inch, 0.148-inch- thick, galvanized-steel, chain-link fabric fencing; minimum 6 feet high with galvanized-steel pipe posts; minimum 2-3/8-inch- OD line posts and 2-7/8-inch- OD corner and pull posts, with 1-5/8-inch- OD top and bottom rails. Provide galvanized steel bases for supporting posts.

PART 3 - EXECUTION

3.1 PREPARATION

- A. Employ a Professional Land Surveyor to perform construction stakeout.
- B. Examine the areas and conditions under which site work is performed. Do not proceed with the work until unsatisfactory conditions are corrected.
- C. Consult the records and drawings of adjacent work and of existing services and utilities which may affect site work operations.
- D. Verify layout information and existing benchmarks before proceeding to lay out the work. Locate and protect existing benchmarks and control points. Preserve permanent reference points during construction.
 - 1. Do not change or relocate benchmarks or control points without prior written approval from the Design Professional. Promptly report lost or destroyed reference points, or requirements to relocate reference points because of necessary changes in grades or locations.
 - 2. Promptly replace lost or destroyed project control points and provide data on new points to the Design Professional. Base replacements on the original survey control points.
- E. Establish and maintain a minimum of two (2) permanent benchmarks of the site, reference to data established by survey control points.
 - 1. Record benchmark locations, with horizontal and vertical data, on Project Record Documents.

3.2 PERFORMANCE

- A. Project Layout Information: Upon request, the Design Professional will provide to the Contractor one digital copy of CADD file in .DWG format of the project as bid, including addenda. The Contractor is responsible for generating geometry for any subsequent layout changes to the Contract drawings. The Design Professional will not provide updated CADD files.

- B. Working from lines and levels established by the property survey, establish benchmarks and markers to set lines and levels as needed to properly locate each element of the Project. Calculate and measure required dimensions within indicated or recognized tolerances.
 - 1. Advise entities engaged in construction activities, of marked lines and levels provided for their use.
 - 2. As construction proceeds, check every major element for line, level and plumb.
- C. Surveyor's Log: Maintain a surveyor's log of control and other survey work. Make this log available for reference.
 - 1. Record deviations from required lines and levels, and advise the Design Professional when deviations that exceed indicated or recognized tolerances are detected. On Project Record Drawings, record deviations that are accepted and not corrected.
 - 2. The project record drawings should indicate as built site conditions including, but not limited to: roadway and parking lot layouts, walk locations, top and inverts of all storm, water and sanitary structures, cross sections of detention basins at a minimum of fifty foot (50') intervals and detention basin top of embankment and spillway and elevations.

3.3 SITE CLEARING

- A. Preparation: Mark areas to be cleared and grubbed and items to be saved with stakes, flags, paint or plastic colored ribbon for approval.
 - 1. Protect benchmarks, utilities, existing trees, shrubs and other landscape features designed for preservation with temporary fencing or barricades satisfactory to the Design Professional.
- B. General: Remove trees, shrubs, grass, and other vegetation, improvements, or obstructions, as required, to permit installation of new construction. Remove similar items elsewhere on site or premises as specifically indicated. Removal includes digging out and off-site disposal of stumps and roots.
 - 1. Carefully and cleanly cut minor roots and branches of trees indicated to remain in a clean and careful manner where such roots and branches obstruct installation of new construction.
- C. Clearing and Grubbing: Clear site of trees, shrubs and other vegetation, except for those indicated to be left standing.
 - 1. Confine clearing to within the limits of the Owner's property.
 - 2. Fell trees in a manner that will avoid damage to vegetation and other improvements which are to be retained.
 - 3. Completely remove stumps, roots, and other debris protruding through ground surface to a depth of eighteen inches (18") below finish grade.
 - 4. Use only hand methods for grubbing inside drip line of trees indicated to remain.

5. Fill depressions caused by clearing and grubbing operations with satisfactory soil material, unless further excavation or earthwork is indicated.
 - a. Place fill material in horizontal layers not exceeding eight inches (8") loose depth, and thoroughly compact each layer to a density equal to adjacent original ground.
- D. Removal of Improvements: Remove existing above-grade and below-grade improvements as indicated to facilitate new construction.
 1. Remove underground pipes where indicated and backfill excavation in accordance with Section 280020 Earthwork.
 2. Saw cut clean edges of concrete and asphalt to be removed. Remove paving and subbase to existing clean earth.

3.4 TOPSOIL STRIPPING

- A. Topsoil is defined as the top layer of the soil profile consisting of existing native surface topsoil or existing in-place surface soil and is the zone where plant roots grow. Its appearance is generally friable, pervious, and black or a darker shade of brown, gray, or red than underlying subsoil; reasonably free of subsoil, clay lumps, gravel, and other objects more than 1 inch in diameter; and free of subsoil and weeds, roots, toxic materials, or other non-soil materials. Acceptable topsoil structure content consists of sand (50%-75%), silt (15%-50%), clay (10%-25%). A list of herbicides applied during the past year should be provided.
 1. Verify depth of topsoil with core samples conducted by a qualified soils scientist.
 2. Do not handle topsoil in a wet or frozen condition. If when squeezed by hand it forms a cohesive mass, as opposed to crumbling and loose, it is too wet.
 3. Strip topsoil to whatever depths encountered in a manner to prevent intermingling with underlying subsoil or other objectionable material.
 - a. Remove heavy growths of grass from areas before stripping.
 - b. Where existing trees are indicated to remain, leave existing topsoil in place within drip lines to prevent damage to root system.
 4. Stockpile topsoil in storage piles in areas indicated on the drawings or as directed by the Design Professional. Construct storage piles to provide complete free drainage of surface water. Cover storage piles to prevent wind erosion and saturation. Seed stockpiles with a temporary seed mix.

3.5 DISPOSAL OF WASTE MATERIALS

- A. Trees, logs, branches, brush, stumps, concrete, asphalt and other debris resulting from clearing and grubbing operations are the property of the Contractor. Remove, recycle or dispose of waste materials in a legal manner.

- B. Do not deposit or bury on the project site debris including asphalt or concrete resulting from the clearing and grubbing work.

** END OF SECTION **

SECTION 280020 EARTHWORK

PART 1 - GENERAL

1.1 SUMMARY

- A. This Section includes the following:
1. Field and Laboratory soil testing.
 2. General excavation and grading to bring the project site to the subgrade elevations.
 3. Supply and placement of required borrow materials from off-site or removal of excess or unacceptable excavated materials off the site.
 4. Preparing and grading subgrades for footings, slabs-on-grade, walks, pavements, landscaping, athletic fields and tennis courts.
 5. Base course for walks and pavements.
 6. Subsurface drainage backfill for walls and trenches.
 7. Excavating and backfilling for footings, underground utilities and appurtenant structures.
 8. Providing satisfactory backfill material, if necessary, by treatment of existing and/or removal of existing and importing of satisfactory materials.
 9. Final subgrading and placement of topsoil for lawns and planting.
- B. Related Sections:
1. Section 280010 "Site Clearing" for site stripping, grubbing, topsoil removal, and protection, and tree protection.
 2. Section 280030 "Erosion and Sedimentation Control for ESC requirements, regulatory compliance.
 3. Section 280040 "Excavation Support and Protection" for trench and excavation support.
 4. Section 286010 "Storm Utility Drainage Piping and Structures" for pipe conveyance, drainage structures and trenching.
 5. Section 284010 "Seeded Turf and Grasses" for finish grading, including placing and preparing topsoil for lawns and planting.
 6. Section 285010 "Exterior Plants" for structural soil requirements, excavation, backfilling and tree installation.
 7. Section 240020 "Cast-in-Place Concrete" for concrete encasings, cradles, and appurtenances for utility systems.
 8. Sections 12, 16 and 18 "Plumbing, Mechanical and Electrical Work" for backfill requirements relative to underground mechanical and electrical utilities.

1.2 UNIT PRICES

- A. Unit Prices:
1. Total price for rock excavation, including removal of rock from the site and backfill with approved materials.

2. Total price for unsuitable soils excavation, including removal of soil from the site and backfill with approved materials.

B. Refer to Paragraph 3.3 for Rock measurement criteria.

1.3 WORK NOT INCLUDED

1.4 DEFINITIONS

A. Excavation consists of the removal of soil and rock encountered to subgrade elevations indicated on drawings and the reuse or disposal of materials removed.

B. Rock: as defined in paragraph 3.3 of this Section.

C. Subgrade: (1) The soil prepared and compacted to support a structure or a pavement system. (2) The elevation of the bottom of a trench in which a sewer or pipeline is laid. (3) The uppermost surface of an excavation or the top surface of a fill or backfill immediately below subbase, drainage fill, or topsoil materials.

D. Borrow: Soil material obtained off-site when sufficient approved soil material is not available from excavations.

E. Aggregate Course: A layer of stone aggregate of specified thickness constructed on the subgrade to support a pavement system, providing drainage or minimize frost action.

F. Subbase Course: The layer placed between the subgrade and base course in a paving system or the layer placed between the subgrade and surface of a pavement or walk.

G. Base Course: The layer placed between the subbase and surface pavement in a paving system.

H. Drainage Fill: Course of washed granular material supporting slab-on-grade placed to cut off upward capillary flow of pore water.

I. Unauthorized excavation consists of removing materials beyond indicated subgrade elevations or dimensions without direction by the Design Professional. Unauthorized excavation, as well as remedial work directed by the Design Professional, shall be at the Contractor's expense.

J. Additional Excavation: Additional excavation consists of removal of materials beyond indicated subgrade or natural subgrade elevations or payment lines with specific direction by the Design Professional.

K. Structures: Buildings, footings, foundations, retaining walls, slabs, tanks, curbs, mechanical and electrical appurtenances, or other man-made stationary features constructed above or below ground surface.

L. Utilities include on-site underground pipes, conduits, ducts, and cables, as well as underground services within building lines.

- M. Test Pits: Excavation in specified locations to verify the horizontal and/or vertical location of existing utilities to verify that no conflict exists with the design.

1.6 SUBMITTALS

- A. Imported Topsoil Source Verification Letter.
- B. Test Pit Data: Top and bottom elevations and horizontal location of pipes, conduits, etc., specified to be located by a test pit.

1.7 QUALITY ASSURANCE

- A. Codes and Standards: Perform earthwork complying with applicable requirements of governing authorities having jurisdiction.
- B. Imported Topsoil Source: Before delivery of topsoil, furnish the Design Professional with written statement giving location of properties from which topsoil is to be obtained, names and addresses of owners, depth to be stripped and herbicide applications during past two (2) years.
- C. Testing and Inspection Service: The Owner shall employ a qualified independent geotechnical engineering testing agency to classify proposed on-site and borrow soils to verify that soils comply with specified requirements and to perform required field and laboratory testing.
- D. Pre-Installation Conference: Conduct a meeting between the Prime/General Contractor, Sub-Contractors, Owner, Geotechnical Engineer and the Design Professional to review the scope of work in this section, coordination with other work, special project conditions and quality standards. Notify all parties and schedule the meeting a minimum of two (2) weeks prior to the anticipated start of the work specified under this Section.
 - 1. Review earthwork procedures and responsibilities including testing and inspection procedures and requirements.
 - 2. Record discussions and agreements and furnish a copy to each participant.

1.8 PROJECT CONDITIONS

- A. Site Information: Prior to beginning earthwork operations, investigate existing underground utility locations, research public and site utility records, and excavate test pits in areas indicated on the construction drawings to verify existing utility depths and locations and to the extent necessary to verify that proposed improvements may be installed in compliance with original design and referenced standards. If the original design is in conflict with the existing utilities, immediately notify the Design Professional of such conflict.
- B. Review and confirm construction access route to all areas of construction with the Owner prior to beginning earthwork operations.
- C. Existing Utilities:

1. Locate existing underground utilities in all areas of work. If utilities are to remain in place, provide adequate means of support and protection during earthwork operations.
 2. Should uncharted, or incorrectly charted, piping or other utilities be encountered during excavation, consult utility owner immediately for directions. Cooperate with Owner and utility companies in keeping respective services and facilities in operation. Repair damaged utilities to satisfaction of utility owner.
 3. Do not interrupt existing utilities serving facilities occupied and used by Owner or others, during occupied hours, except when permitted in writing by the Design Professional and then only after acceptable temporary utility services have been provided.
 4. Provide a minimum forty-eight (48) hours notice to the Design Professional and receive written notice to proceed before interrupting any utility.
- D. Demolish and completely remove from site existing underground utilities indicated to be removed. Coordinate with utility companies to shut off services if lines are active.
- E. Blasting: The use of explosives is prohibited.
- F. Protection of Persons and Property: Barricade open excavations occurring as part of this work and post with warning lights.
1. Operate warning lights as recommended by authorities having jurisdiction.
- G. Protect existing improvements from damage caused by settlement, lateral movement, undermining, washout and other hazards created by earthwork operations.
1. Perform excavation within dripline of large trees in accordance with Section 280010.

PART 2 - PRODUCTS

2.1 SOIL MATERIALS

- A. General: Provide approved satisfactory non-contaminated borrow soil materials from off-site when sufficient approved soil materials are not available from excavations, at no additional cost to the Owner.
1. Satisfactory Off-Site Borrow and Backfill Materials: ASTM D 2487 Soil Classification Groups GW, GM, SW, CL, ML and SM; free of rock or gravel larger than four inches (4") in any dimension, debris, waste, frozen materials, vegetation and other deleterious matter.
 2. Unsatisfactory Off-Site Borrow and Backfill Materials: ASTM D 2487 Soil Classification Groups GP, GC, MH, CH, OL, OH, and PT.
- B. Satisfactory On-Site Borrow, Backfill and Fill Materials: Naturally occurring, non-contaminated soils of the site free of rock, or gravel larger than 4 inches in any dimension, debris, waste, frozen material, vegetation and other deleterious matter, providing required compaction densities can be achieved, which may include approved methods of modification with amendments and moisture control.

- C. Product and source are required to be currently approved by PennDOT for the following: Specified Subbase Material, Engineered Fill, Bedding Material, Drainage Fill, Filtering Material, Pipe Bedding Material and Other Aggregate Stone Materials.
- D. Subbase Material: Crushed aggregate meeting the requirements of PennDOT 2A Coarse Aggregate, and produced from a Type A source stone, as specified in PennDOT Publication 408.
- E. Engineered Fill: Crushed aggregate meeting the requirements of PennDOT 2A Coarse Aggregate, and produced from a Type A source stone, as specified in PennDOT Publication 408.
- F. Drainage Fill: AASHTO No. 57 Aggregate meeting the requirements of PennDOT Publication 408 will be acceptable.
- G. Filter Material: Type A Concrete Sand meeting the requirements of PennDOT Publication 408.
- H. Pipe Bedding Material: AASHTO No. 8 Aggregate meeting the requirements of PennDOT Publication 408, and produced from a Type A source stone.
- I. Utility Trench Backfill Beneath Paving or Structures: Crushed aggregate meeting the requirements of PennDOT 2A Coarse Aggregate, and produced from a Type A source stone, as specified in PennDOT Publication 408.
- J. Impervious Fill: Clay and silty clays, fine grained sandy clays capable of compacting to a dense state under optimum moisture conditions, matching soil groups CL or CH, ML or SC of the Unified Soil Classification.
- K. Topsoil: Uppermost layer of on-site soil which is fertile, friable and naturally loamy.
- L. Imported Topsoil:
 - 1. Naturally occurring soil which is fertile, friable, naturally loamy and reasonably free of subsoil, clay lumps, brush, weeds, roots, stumps, stones larger than one inch (1”) in any dimension, and other extraneous or toxic matter harmful to plant growth.
 - 2. The particle gradation of the topsoil shall be within the following range as a percentage of the total mix:
 - Sand (0.500 MM to 0.050 MM) up to 50 – 75%
 - Silt (0.050 MM to 0.005 MM) up to 15- 50%
 - Clay (0.005 MM and smaller) up to 10 – 25%
 - 3. Organic matter content by weight:
 - 4% minimum
 - 10% maximum

2.2 CONCRETE FLOW FILL MIX

- A. PennDOT Type A or B.

2.3 GEOTEXTILE FABRIC

- A. Manufacturer's standard woven or non-woven pervious geotextile fabric of polypropylene, nylon or polyester fibers, or a combination.
 - 1. Provide filter fabrics that meet or exceed the listed minimum physical properties determined according to ASTM D 4759 and the referenced standard test method in parentheses following:
 - a. Puncture (ASTM D4833) 160 lbs.
 - b. Mullen Burst (ASTM D 3786) 600 psi
 - c. Grab Tensile Strength (ASTM D 4632): 300 Lb.
 - d. Apparent Opening Size (ASTM D 4751): #100 U.S. Standard Sieve
 - e. Flow Rate (ASTM D 4491): 50 Gallons Per Minute Per Sq. Ft.

2.4 DETECTABLE WARNING TAPE

- A. Acid- and alkali-resistant, polyethylene film warning tape manufactured for marking and identifying underground utilities, a minimum of 6 inches (150 mm) wide and 4 mils (0.1 mm) thick, continuously inscribed with a description of the utility, with metallic core encased in a protective jacket for corrosion protection, detectable by metal detector when tape is buried up to 30 inches (750 mm) deep; colored in accordance with authorities having jurisdiction.

PART 3 - EXECUTION

3.1 PREPARATION

- A. Prior to commencement of any excavation on the project site, excavate the test pits in the areas indicated, to verify the location of existing utilities. Comply with Pennsylvania Act 287 as amended by Act 38; contact Pennsylvania One Call at 800-242-1776 at least three days before digging, drilling, etc. Prior to excavation of test pits, notify the utility authority having jurisdiction and allow them the opportunity to be present to witness the excavation.
 - 1. Excavate adjacent to the utility by hand.
 - 2. Document elevations and horizontal locations.
 - 3. Upon completion, backfill and compact excavation to the satisfaction of the authority having jurisdiction.
- B. Protect subgrades and foundation soils against freezing temperatures or frost. Provide protective insulating materials as necessary.
- C. Topsoil stripping and tree protection is specified in the Section 280010 "Site Clearing and Construction Layout".

3.2 DEWATERING

- A. Prevent surface water and subsurface or ground water from entering excavations, from ponding on prepared subgrades, and from flooding Project Site and surrounding area.
- B. Protect subgrades and foundation soils from softening and damage by rain or water accumulation.
 - 1. Direct drainage away from building sites.
 - 2. Do not allow water to accumulate in excavations. Remove water to prevent softening of foundation bottoms, undercutting footings, and soil changes detrimental to stability of subgrades and foundations. Provide and maintain pumps, well points, sumps, suction and discharge lines, and other dewatering system components necessary to convey water away from excavations and building sites, and to suppress groundwater levels to at least 2 feet below working subgrades.
 - 3. Establish and maintain temporary drainage ditches and other diversions outside excavation limits to convey rain water and water removed from excavations to catch basins or run-off areas. Do not use trench excavations as temporary drainage ditches.

3.3 EXCAVATION

- A. Excavation is CLASSIFIED and includes excavation to the natural subgrade elevations indicated or required for construction and shall be classified as earth and rock.
 - 1. Earth: Earth Excavation includes excavation of pavements and other obstructions visible on surface; underground structures, utilities, and other items indicated to be demolished and removed; together with earth and other materials encountered that are not classified as rock or unauthorized excavation. Earth Excavation shall mean necessary removal of all necessary earth type materials including sand, gravel, silt, clay, quicksand, shale, loam and all other earth type materials as they are encountered.
 - 2. Rock: Rock Excavation includes removal and disposal of both Bulk and Trench rock materials encountered that cannot be dislodged and excavated with modern, track-mounted, heavy-duty excavating equipment described in Paragraph 3.5.C. and 3.5.D without drilling, blasting, ram hammering or ripping.
 - 3. Typical of materials classified as rock are boulders one (1) cubic yard or more in volume, solid rock, rock in ledges, and rock-hard cementitious aggregate deposits. Boulders smaller than one (1) cubic yard in volume shall be considered as earth excavation. Intermittent drilling, blasting, or ripping performed to increase production and not necessary to permit excavation or material encountered will be classified as earth excavation.
 - 4. Do not perform rock excavation work until material to be excavated has been cross-sectioned and classified by Design Professional. Such excavation will be paid on basis of contract conditions relative to changes in work.
 - 5. Rock payment lines are limited to the following:
 - a. Two feet outside of concrete work for which forms are required, except footings.

- b. One (1) foot outside perimeter of footings and twenty-four (24) inches below bottom (unless shown to rest on rock).
 - c. In pipe trenches, six (6) inches below invert elevation of pipe and two (2) feet wider than inside diameter of pipe, but not less than three (3) feet minimum trench width.
 - d. Under slabs on grade, six inches below bottom of concrete slab.
 - e. Boulders which can be removed with specified equipment but extend beyond limits of responsibility and/or rock payment lines shall be considered within rock payment lines.
- 6. When a question arises concerning classification of material to be excavated, Design Professional shall be notified and their decision shall be final. No extra payment will be allowed unless a formal construction change directive or a change order is prepared.
 - 7. Contractor shall keep a running account of all rock excavation completed. A plan shall be kept noting location, quantity, type of excavation and date of removal for all rock excavation, and each quantity shall be initialed by Design Professional or his official field representative directly on this plan signifying agreement to its removal. When all excavation work is completed, this rock excavation report shall be submitted to serve as a permanent record or rock excavation work completed.

B. Earth Excavation Types: Earth Excavation includes bulk and trench earth excavation:

- 1. **Bulk Earth Excavation:** Bulk earth excavation includes excavation of subsoil required to accommodate building foundations, slabs-on-grade, paving, site structures, final site contours and other construction operations by one of the following methods.
 - a. **Hand Excavation:** Hand excavation is defined as digging soil by hand shoveling, including loosening with a pick and no more than a total lift of six (6) feet. Unit prices shall include labor, materials and platforms and shoring if required, and disposal.
 - b. **Machine Excavation:** Machine excavation is defined as excavation requiring power equipment and includes transportation, set-up/unrigging and disposal.
- 2. **Trench Earth Excavation:** Earth excavation for trenches and pits includes removal and disposal of earth material not defined as rock excavation, required to accommodate footings utilities, sanitary storm and waste water piping, culverts and other subgrade site work. Trenches in excess of 10'-0" wide and pits in excess of 30'-0" in either length or width are classified as bulk excavation.
 - a. **Hand Excavation:** Hand excavation is defined as digging soil by hand shoveling, including loosening with a pick and no more than a total lift of six (6) feet. Unit prices shall include labor, materials and platforms and shoring if required, and disposal.

- b. Machine Excavation: Machine excavation is defined as excavation requiring power equipment and includes transportation, set-up/unrigging and disposal.
- C. Rock Excavation Types: Rock excavation includes bulk and trench rock excavation.
 - 1. Bulk Rock Excavation: Bulk rock excavation includes removal and disposal of materials and obstructions, except boulders, which are encountered and cannot be removed with heavy-duty excavating equipment without drilling, blasting, ram hammering or ripping. Excavation equipment equal to Caterpillar Model No. 973 or equivalent track-mounted loader, rated at not less than 54,000 pounds operating weight, 210 HP rated power and developing minimum of 44,000-pound bucket breakout force (measured in accordance with SAE J732). Excavation which can be accomplished with this equipment or equivalent shall be considered as Earth Excavation. Comply with any of the following methods for removal of rock.
 - a. Ripping: Rock Excavation by Ripping Methods shall mean removal of rock type materials using tractors equipped with rock ripping mechanisms such as No. D-8 and No. D-9 Ripper Tractors by Caterpillar Company. Rock ripping methods shall be attempted for all bulk rock excavation and shallow (4'-0" ±) trench rock excavation, as it is encountered at the site. Existing site rock which cannot be ripped with ripper tractors, and this fact is established after trial ripping, shall be excavated by rock excavation methods employing ram hammering.
 - b. Hand Method: Rock excavation by hand method shall mean removal of rock type materials by a worker using pneumatic vibrating chippers.
 - c. Ram Hammer: Rock excavation by ram hammer method shall mean removal of rock type materials using boom mounted pneumatic, impact hammer equipment.
 - d. Boulders: Boulder excavation shall mean removal of free floating rock by excavation equipment at least equal to Caterpillar Model No. 973 or No. 320 track mounted equipment. Boulders which cannot be removed with the above equipment shall be removed and compensated for by hand method or ram-hammer. Boulders encountered shall be set aside for measurement, then removed from the site, including those not qualified as rock. Large boulders shall be split into smaller units as required for disposal at no additional cost.
 - 2. Trench Rock Excavation:
 - a. Rock excavation for footings trenches and pits includes removal and disposal of materials and obstructions encountered that cannot be excavated with a 1.0 cubic yard (SAE heaped) capacity, Type T, 36 inch side bucket on a track-mounted power excavator, equivalent to Caterpillar Model No. 320, and rated at not less than 128 HP flywheel and 44,000-pound weight with a short stick.
 - b. Trenches in excess of 10 feet in width and pits in excess of 30 feet in either length or width are classified as bulk rock excavation.

- c. Ripping, hand method, ram hammer, and boulder rock removal methods may be used for trench rock removal. Reference Bulk Rock Excavation for description and definition of these methods.
- D. Excavation to Bedrock:
 - 1. Where rock and/or bedrock is encountered at proposed subgrade elevations, undercut and replace with suitable fill material, regardless of the character of the rock/bedrock to the following depths:
 - a. Utility Trenches: 6 inches.
 - b. Lawn Areas: 18 inches
 - c. Building Footings: 6 inches.
 - 2. Backfill for Undercut:
 - a. For lawn areas: Satisfactory fill.
 - b. For building footings: Engineered fill.

3.4 STABILITY OF EXCAVATIONS

- A. General: Comply with applicable requirements of Section 280040 Excavation Support and Protection.
- B. Comply with local, state and federal codes, ordinances, and requirements of authorities having jurisdiction to maintain stable excavations.
 - 1. Slope sides of excavations to comply with local codes and ordinances having jurisdiction. Shore and brace where sloping not feasible because of space restrictions or stability of material excavated, at no additional cost to Owner.
 - 2. Maintain sides and slopes of excavations in safe condition until completion of backfilling.
- C. Shoring and Bracing: Where shoring or bracing is required, provide materials for shoring and bracing, such as sheet piling, uprights, stringers and cross-braces, in good serviceable condition.
 - 1. Establish requirements for trench shoring and bracing to comply with all codes and authorities having jurisdiction.
 - 2. Maintain shoring and bracing in excavations, regardless of time period excavations remain open. Carry down shoring and bracing as excavation progresses.
 - 3. Provide permanent steel sheet piling or pressure-creosoted timber sheet piling wherever subsequent removal of sheet piling might permit lateral movement of soil under adjacent structures.

3.5 SINKHOLES

- A. Should sinkholes or other peculiar subsurface conditions be encountered during grading or construction, the contractor shall immediately notify the Owner by telephone, and within 24 hours in writing, and take steps necessary to prevent surface runoff from entering the sinkhole until a remedy is provided by a registered Geo-technical Consultant.

3.6 EXCAVATION FOR STRUCTURES

- A. Conform to elevations and dimensions shown within a tolerance of plus or minus 0.10 foot, and extending a sufficient distance from footings and foundations to permit placing and removal of concrete formwork, installation of services, and other construction and for inspection.
- B. Excavations for Footings and Foundations: Minimize disturbance to bottom of excavation. In soil subgrades, remove any material loosened by excavation; thoroughly compact underlying soil, and backfill to the specified subgrade elevation with engineered fill. Trim bottoms to required lines and grades to leave solid base to receive other work. Whether indicated or not, bottom of footings shall be a minimum of 3'-0" below finish grade. Undercut footings by 6 inches minimum and backfill with Engineered Fill. Adjust as required including excavation and backfill at no additional cost to Owner.
- C. Excavation for Underground Tanks, Basins, and Mechanical or Electrical Structures: Conform to elevations and dimensions indicated within a tolerance of plus or minus 0.10 foot; plus a sufficient distance to permit placing and removal of concrete formwork, installation of services, and other construction and for inspection. Do not disturb bottom of excavations, intended for bearing surface.

3.7 EXCAVATION FOR WALKS AND PAVEMENTS

- A. Excavate surfaces under walks and pavements to indicated cross sections, elevations, and grades. Unless noted otherwise, maintain subgrade with same slope and pitch as indicated for finish surface.

3.8 EXCAVATION FOR UTILITY TRENCHES

- A. Excavate trenches to indicated slopes, lines, depths, and invert elevations.
 - 1. Beyond building perimeter, excavate trenches for water lines to allow installation of top of pipe below frost line.
- B. Excavate trenches to uniform widths to provide a working clearance on each side of pipe or conduit. Excavate trench walls vertically from trench bottom to twelve inches (12") higher than top of pipe or conduit.
 - 1. Clearance: A minimum of twelve inches (12") each side of pipe or conduit.
- C. Trench Bottoms: Excavate and shape trench bottoms as required to place bedding material and to provide uniform bearing and support of pipes and conduit. Shape subgrade to provide continuous support for bells, joints, and barrels of pipes and for

joints, fittings, and bodies of conduits. Remove large stones and sharp objects to avoid point loading.

1. Remove unstable, soft and unsuitable materials at or below the bottom of the trench upon which bedding material is to be laid.
2. Where encountering rock or another unyielding bearing surface, carry trench excavation six inches (6") below outside surface of pipe to receive bedding course.
3. Refer to article, "Utility Trench Backfill" for bedding and backfill requirements.

3.10 APPROVAL OF SUBGRADE

- A. Notify Design Professional when excavations have reached required subgrade.
- B. Proof-roll prepared subgrade surface to check for unstable areas and areas requiring additional compaction. Perform proof-rolling with a ten ton minimum roller or loaded tandem-axle dump truck as directed. Do not proof roll wet or saturated subgrades, or subgrades occurring within two to three feet of the water table. Do not proof-roll subgrades intended for subsurface stormwater infiltration beds.
- C. Do not backfill trenches until tests and inspections have been made and the Design Professional has been informed in writing of the test results and authorizes proceeding with the backfill. Do not damage or displace pipe systems.
- D. Place and compact specified backfill material upon remaining bedrock that was undercut. Refer to Article 3.3.D for undercut and backfill requirements.
- E. When Design Professional determines that unforeseen unsatisfactory soil is present at and below subgrade, undercut and replace with compacted backfill or fill material as directed.
 1. Unforeseen additional excavation and replacement material will be paid according to the contract provisions for changes in work. No such payment will be made, however, if the subgrade material became saturated and soft as a result of the contractor's failure to properly protect the excavation or properly divert surface runoff away from excavations.
- F. Reconstruct subgrades damaged by freezing temperatures, frost, rain, accumulated water, or construction activities, at the contractor's expense.
- G. No stone aggregate base course or subbase course shall be placed until the subgrade of the entire section or portion of the project under preparation is approved for line, grade and stability.
- H. No topsoil is to be placed until the subgrade of an entire sub-area or portion of project under preparation is brought to an even plane and uniform depth consistent with the proposed finish grade as required by the drawings. See Paragraph Re: Topsoiling.

3.11 UNAUTHORIZED EXCAVATION

- A. Unauthorized excavation consists of removal of materials beyond indicated subgrade elevations or dimensions without specific direction of Design Professional. Unauthorized excavation, as well as remedial work shall be at contractor's expense.
- B. Fill unauthorized excavation in rock under foundations or wall footings by extending indicated bottom elevation of concrete foundation or footing to excavation bottom, without altering required top elevation. Lean concrete fill may be used to bring subgrades to proper elevation. Fill unauthorized excavations in soil under foundations or wall footings with engineered fill.
 - 1. Elsewhere, backfill and compact unauthorized excavations as specified for authorized excavations of the same classification.

3.12 ADDITIONAL EXCAVATION:

- A. When excavation has reached required subgrade elevations:
 - 1. If unsuitable or excessively fractured bearing materials are encountered at required subgrade elevations, carry excavations to the level decided by the Design Professional and replace excavated material as authorized by the Design Professional.
 - 2. Removal of unsuitable material and its replacement as authorized will be paid on basis of contract conditions relative to changes in work.

3.13 STORAGE OF SOIL MATERIAL

- A. Stockpile excavated materials acceptable for use as backfill and fill soil materials, including acceptable borrow materials.
 - 1. Stockpile soil materials without intermixing.
 - 2. Place, grade and shape stockpiles to drain surface water.
 - 3. Provide protection to prevent wind-blown dust, and accumulation of excessive moisture that may preclude use of material as intended for use on the project.
 - 4. Stockpile soil materials away from edge of excavations. Do not store within drip line of remaining trees.
 - 5. Dispose of excess soil material and waste materials as specified herein.

3.14 BACKFILL

- A. Prior to placing backfill contractor is to provide Owner's representative with the written anticipated Schedule of Backfill Operations a minimum of forty-eight (48) hours in advance. No backfill shall be placed without the Owner's representative or geo-technical testing agent at the site.
- B. Backfill excavations promptly, but not before completing the following:
 - 1. Acceptance of construction below finish grade including, where applicable, damp-proofing, water-proofing, and perimeter insulation, pipe bedding and joints.

2. Surveying locations of underground utilities for record documents.
3. Testing, inspecting, and approval of underground utilities.
4. Removal of all concrete form-work from excavation.
5. Removal of trash and debris from excavation.
6. Removal of temporary shoring and bracing, and sheeting.
7. Installing permanent or temporary horizontal bracing on horizontally supported walls.
8. Testing and inspection of subgrade beneath building foundations.

3.15 UTILITY TRENCH BACKFILL

- A. Prior to placing backfill contractor is to provide Owner's representative with the written anticipated Schedule of Backfill Operations a minimum of forty-eight (48) hours in advance. No bedding or backfill shall be placed without the Owner's representative or geo-technical testing agent at the site.
- B. Refer to Article "Excavation for Utility Trenches" for trench subgrade preparation.
- C. Bedding material: for pipes and conduit place AASHTO No. 8 bedding material upon prepared specified subgrade.
 1. Carefully compact bedding material under pipe haunches to 95 percent modified proctor (ASTM D -1557) and bring backfill evenly up on both sides and along the full length of utility piping or conduit to avoid damage or displacement of utility system.
- D. Place and compact pipe bedding course on rock and other unyielding bearing surfaces and to fill unauthorized excavations. Shape pipe bedding material to provide continuous support for bells, joints, and barrels of pipes and for joints, fittings, and bodies of conduits.
- E. Haunch Zone: Place and shape bedding material to support haunch zone of pipe circumference as detailed.
- F. Initial Backfill: Place and compact initial backfill using crushed stone conforming to AASHTO No. 8 aggregate, to a height of twelve inches (12") over the utility pipe or conduit.
- G. Final Backfill:
 1. Under paved areas, backfill above Initial backfill in 4" layers with PENNDOT 2A stone to subgrade, compact each layer to 95 percent modified proctor. (100 percent of standard proctor is acceptable for 2A course aggregate only).
 2. Under unpaved areas, backfill above Initial backfill, final backfill shall be satisfactory earth containing no rock larger than four (4") inches in any dimension placed in 4" layers and compacted to 95 percent Modified Proctor.

- H. Backfill trenches with concrete where trench excavations pass within eighteen inches (18") of column or wall footing and which are carried below bottom of such footings, or which pass under wall footings. Place concrete to level of bottom of adjacent footing.
- I. Install warning tape directly above utilities, 12 inches below finished grade, except 6 inches below subgrade under pavements and slabs.
- J. Coordinate backfilling with utilities testing.
- K. Fill voids with approved backfill materials concurrently with the removal of shoring and bracing, and sheeting.
- L. Place backfill and fill materials in layers not more than four inches (4") in loose depth.
 - 1. Rock larger than four (4) inches in any dimension is prohibited.
- M. Backfill narrow trenches of fifteen inches (15") and less in width that traverse roads, paved areas, running tracks, etc. with concrete flow-fill. Fill trench completely full with flowable fill under the entire pavement cross-section. Outside the limits of the paved area, taper flowable fill at forty-five degrees (45°) between pavement subgrade and the bottom of the trench.

3.16 SUBSURFACE DRAINAGE BACKFILL

- A. Subsurface Drain: Place a layer of filter fabric around perimeter of drainage trench or at footing, as indicated. Place a six inch (6") compacted course of filtering material on filter fabric to support drainage pipe. After installing and testing, encase drainage pipe in a minimum of six inches (6") of compacted filtering material and wrap in filter fabric, overlapping edges at least six inches (6").
- B. Drainage Backfill: Place and compact drainage backfill of filtering material over subsurface drain, in width indicated, to within twelve inches (12") of final subgrade. Overlay drainage backfill with one (1) layer of filter fabric, overlapping edges at least six inches (6").
- C. Impervious Fill: Place and compact impervious fill material over drainage backfill to final subgrade.

3.17 FILL

- A. Prior to placing fill contractor is to provide Owner's representative with the written anticipated Schedule of Fill Operations a minimum of forty-eight (48) hours in advance. No fill shall be placed without the Owner's representative or geo-technical testing agent at the site.
- B. Preparation: Remove vegetation, topsoil, debris, wet and unsatisfactory soil materials, obstructions, and deleterious materials from ground surface prior to placing fills.

1. Plow, strip, or break up sloped surfaces steeper than one (1) vertical to four (4) horizontal so fill material will bond with existing surface.
- C. When existing ground surface has a density less than that specified under “Compaction” for pavements or structures, break up ground surface, pulverize, moisture-condition to optimum moisture content, and compact the top twelve (12) inches to required percentage of maximum density. Refer to other Paragraphs re: “Fill” and “Moisture Control”.
- D. Proof Rolling: Proof roll the natural subgrade under all walls, pavements and concrete slabs prior to placing subbase or compacted fill material. Do not proof roll wet or saturated subgrades. Proof roll after clearing and grubbing and prior to fill placement in areas to receive fill, and after excavation to specified subgrade elevation in cut areas.
- E. Place acceptable On-Site Fill Material in layers not more than eight inches (8”) in loose depth for material compacted by medium to heavy (4-ton or larger) compaction equipment, and not more than four inches (4”) in loose depth for material compacted by hand-operated tampers.
1. Rock larger than four (4) inches in any dimension is prohibited within the top two (2) lifts (loose depth) of the subgrade.
 2. Below the top two (2) lifts, rock larger than six (6) inches in any dimension is prohibited.
 3. Adjacent to structures, piping or conduit, place acceptable on-site material (2.1.B) evenly to required elevations. Take care to prevent wedging action of backfill against structures or displacement of piping or conduit by carrying material uniformly around structure, piping or conduit to approximately same elevation in each lift.
- F. Materials encountered during site operations which are unsatisfactory for reuse or are too wet shall:
1. Be excavated and hauled off site to an approved spoils area,
 2. If satisfactory but too wet, be scarified and dried out until adequate moisture conditions, as defined by the geo-technical representative, is achieved,
 3. Be treated with amendments such as limestone products to achieve optimum conditions,
 4. Be replaced with approved satisfactory material.

3.18 ABANDONMENT OF PIPES AND STRUCTURES

- A. Abandoned Pipes:
1. Corrugated metal pipe (CMP) and terra cotta pipe twelve inches (12”) and above shall be filled with flowable concrete fill via manual or pump method. Pipes shall be completely sealed at points of connections and joints to prevent infiltration of water and entry by rodents or insects.
 2. Plastic pipe (PVC, PE) of any size shall be filled with flowable concrete fill via the manual or pump method.
 3. Concrete, ductile iron, steel or other rigid wall pipe twelve inches and above shall be closed at open ends as follows:

- a. Provide sufficiently strong closures to withstand hydrostatic or earth pressure that may result after ends of abandoned utilities have been closed.
 - b. Close open ends of concrete or masonry utilities indicated to remain in place with not less than eight inch (8") thick brick masonry bulkheads.
 - c. Close open ends of ductile iron and steel piping with threaded metal caps, plastic plugs, or other acceptable methods suitable for size and type of material being closed. Wood plugs are not acceptable. Pipes shall be completely sealed at points of connection and joints to prevent infiltration of water and entry by rodents or insects.
- B. Abandoned Structures: Remove structure and close open ends of the remaining piping, or remove top of structure down to not less than three feet (3') below final grade; punch or drill holes in bottom slab or base of side walls to allow drainage through structure, fill structure with AASHTO NO.8 stone to the top of structure remaining, and backfill the excavation with compacted earth fill.

3.19 MOISTURE CONTROL

- A. Uniformly moisten or aerate subgrade and each subsequent fill or backfill lift before compaction to within two percent (2%) of optimum moisture content as determined by ASTM D1557.
- 1. Do not place backfill or fill material on surfaces that are muddy or frozen.
 - 2. Remove and replace, or scarify and air-dry satisfactory soil material that is too wet to compact to specified density.
 - a. Stockpile or spread and air dry removed wet satisfactory soil material.

3.20 COMPACTION

- A. Place backfill and fill materials in lifts not more than eight inches (8") in loose depth for material compacted by heavy (10 ton or larger) compaction equipment, and not more than four inches (4") in loose depth for material compacted by hand-operated tampers.
- B. Before compaction, moisten or aerate each lift as necessary to provide moisture content indicated under Moisture Control.
- C. Control soil compaction during construction providing the minimum number of tests for each area indicated under Field Quality Control. The exposed subgrade should be proof rolled, tested and observed by the testing agency prior to fill placement.
- D. Percentage of Maximum Dry Density Requirements: Compact soil to not less than the following percentages of maximum dry density according to ASTM D1557 (Modified Proctor):
- 1. Subbase and base courses: Compact to not less than 100 percent (100%).
 - 2. Under structures, building slabs, steps, heavy duty pavements, and running tracks: Compact the top twelve inches (12") below subgrade and each lift of backfill or fill material at ninety-five percent (95%).

3. Under walkways and pedestrian pavements: Compact the top twelve inches (12") below subgrade and each lift of backfill or fill material to at least ninety-five percent (95%).
4. Under lawn or unpaved areas: Compact the top twelve (12) inches below subgrade and each lift of backfill or fill material to ninety percent (90%).
5. Utility trenches under lawn or unpaved areas: Compact each layer of backfill or fill material to ninety-five percent (95%).
6. Utility trenches under roads or paved areas: Compact each layer of backfill or fill material to not less than one hundred percent (100%).

3.21 GRADING

- A. General: Uniformly grade areas to a smooth surface, free from irregular surface changes. Comply with compaction requirements and grade to cross sections, lines, and elevations indicated.
 1. Provide a smooth transition between existing adjacent grades and new grades.
 2. Cut out soft spots, fill low spots, and trim high spots to conform to required surface tolerances.

- B. Site Grading: Slope grades to direct water away from buildings and to prevent ponding. Finish subgrades to required elevations within the following tolerances.
 1. Swales: Grade swale bottoms to line and grade as per plan and as directed. Swale bottoms shall be free of undulations and permit free, complete drainage to collection points. At stormwater inlets, grade swales with gradual approach and without abrupt sumps unless specifically detailed. Should field conditions differ from contract documents, the contractor shall advise the Owner prior to proceeding, for direction and resolution. Maintain accurate grade line and cross-section of swales during placement of topsoil and seeding operations. The Owner reserves the right to reject and require remedial measures to work which is in noncompliance.
 2. Lawn or Unpaved Areas: Finish subgrades to receive topsoil to within not more than 0.05' above or below required subgrade elevations.
 3. Walks: Shape surface of areas under walks, to line, grade and cross-section, with finish surface not more than 0.10' above or below required subgrade elevation.
 4. Pavements: Shape surface of areas under pavement to line, grade and cross-section, with finish surface not more than 0.10' above or below required subgrade elevation, compacted as specified, and graded to prevent ponding of water after rains. Include such operations as plowing, disking, and any moisture or aerating required to provide optimum moisture content for compaction. Fill low areas resulting from removal of unsatisfactory soil materials, obstructions, and other deleterious materials, using satisfactory soil material. Shape in line, grade and cross-section as indicated. Degree of finish required will be that ordinarily obtainable from either blade grader or scraper operations.

- C. Grading Surface within Building Lines: Grade smooth and even, free of voids, compacted as specified, and to required elevation. Provide final grades within a tolerance of one-half inch ($\frac{1}{2}$ ") when tested with a ten foot (10') straightedge.

3.22 SUBBASE AND BASE COURSES

- A. Under pavements, walks, steps, and ramps, place subbase or base course on approved subgrade. Place base course material over subbases of pavements where applicable.
 - 1. Under walks and pavements, use subbase or base material, or satisfactory excavated or borrow soil material or combination of both.
 - 2. Under steps and ramps, use subbase material.
 - 3. Under building slabs, use subbase material, unless specified otherwise.
 - 4. Under footings and foundations, use engineered fill.
 - 5. In excavations, use satisfactory excavated borrow material, except where otherwise specified.
 - 6. Under grass, use satisfactory excavated or borrow soil material.
 - 7. Shape subbase and base to required crown elevations and cross-slope grades.
 - 8. When thickness of compacted subbase or base course is six inches (6") or less, place materials in a single layer.
 - 9. When thickness of compacted subbase or base course exceeds six inches (6"), place materials in equal layers, with no layer more than six inches (6") thick or less than three inches (3") thick when compacted.
 - 10. Proof-roll prepared subbase surface to check for unstable areas and areas requiring additional compaction.
- B. Pavement Shoulders: Place shoulders along edges of subbase and base course to prevent lateral movement. Construct shoulders at least twelve inches (12") wide of acceptable soil materials and compact simultaneously with each subbase and base layer.

3.23 DRAINAGE FILL

- A. Under slabs-on-grade, place drainage fill course on prepared subgrade for support of building slabs.
 - 1. When compacted thickness of drainage fill is six inches (6") or less, place materials in a single layer.
 - 2. When compacted thickness of drainage fill exceeds six inches (6") thick, place materials in equal layers, with no layer more than six inches (6") thick or less than three inches (3") thick when compacted. Maintain optimum moisture content for compacting material during placement operations.

3.24 TOPSOILING

- A. General: Stockpile on-site topsoil for re-use. If quantity of stockpiled topsoil is insufficient, provide additional topsoil at no additional cost to the Owner. Obtain topsoil from local sources or from areas having similar soil characteristics to those found at site of work. Obtain topsoil from naturally well-drained sites where topsoil occurs in depth of not less than six inches (6"), do not obtain from bogs or marshes.
- B. After the areas required to be topsoiled have been brought to subgrade, and immediately prior to placing the topsoil, loosen the subgrade, wherever excessively compacted by

traffic or other causes, to a depth of 4" – 5" inches, to permit bonding of the topsoil to the subgrade.

1. Scarify with a vibrating tine cultivator or similar equipment. Course, lumpy subsoil resulting after cultivation shall receive secondary tillage with disc or rototilling. Tilled subsoil shall be conditioned to a loose, granular texture prior to spreading topsoil. The plane of the subgrade must reflect the proposed finish surface grade. Using the teeth of a backhoe, front end loader or other such equipment is unacceptable.
 2. Prior to and following scarification, remove all stones, stumps, roots, brush, wire, grade stakes, or other objects larger than one inch (1") in thickness or diameter and legally dispose.
- C. Spread topsoil uniformly on all areas not covered by paving or other construction and evenly spread to a minimum thickness of **six inches** (6"). Should excess topsoil remain after meeting the minimum thickness requirement, notify the Owner for direction. Spread topsoil in such a manner that seeding can proceed with little additional soil preparation or tillage. Adjacent to paved surfaces, place topsoil at one inch (loose depth) above edge of pavement.
- D. Correct irregularities in the surface resulting from topsoiling or other operation in order to prevent the formation of depressions where water will stand. Do not place when subgrade is excessively wet, extremely dry, or in a condition otherwise detrimental to proper grading.
- E. Remove from full depth of topsoil all stones, stumps, roots, weeds, brush, wire, grade stakes, or other objects larger than one inch (1") in thickness or diameter.
- F. Rock-picking equipment shall be operated at a controlled speed to allow thorough, efficient removal of all rocks and stones.
- G. Minimize excessive traffic over topsoil. Repair areas of topsoil damaged from traffic or erosion.

3.25 FIELD QUALITY CONTROL

- A. Testing Agency Services: The Owner shall engage a qualified Testing Agency to perform testing and inspections. Allow Testing Agency full access to site to perform required tests and inspections. Do not proceed until test results for previously completed work verify compliance with requirements.
- B. When testing agency reports that subgrades, fills, or backfills are below specified density, scarify and moisten or aerate, or remove and replace soil to the depth required, re-compact and retest until required density is obtained. Provide additional compaction and testing at no additional cost to the Owner.
- C. Frequency of Field Density Tests:

1. Subgrade and Engineered Fill under structures: One test per 5,000 square feet of lift surface; once every 25 lineal feet of foundation fill or backfill; and a minimum of 3 tests per lift.
2. Paved Areas: At subgrade and at each compacted fill and backfill lift, one (1) field in-place density test for every two thousand five hundred square feet (2500 SF) or less of paved area or building slab, but in no case fewer than three (3) tests, or greater frequency as directed.
3. Trench Backfill: In each compacted backfill lift, one (1) field in-place density test for each fifty feet (50') or less of trench, but no fewer than three (3) tests.
4. Lawn Areas: In each compacted backfill lift, one (1) field in-place density test for each two thousand five hundred square feet (2500 SF), but no fewer than three (3) tests.

3.26 PROTECTION

- A. Protecting Graded Areas: Protect newly graded areas from flooding, accumulation of water, freezing, erosion and traffic. Keep free of trash and debris.
- B. Repair and re-establish grades to specified tolerances where completed or partially completed surfaces become eroded, rutted, settled, or lose compaction due to subsequent construction operations or weather conditions.
 1. Scarify or remove and replace material to depth directed by the Owner; reshape and re-compact at optimum moisture content to the required density prior to further construction.
- C. Settlement: Where settlement is measurable or observable at excavated areas during the Project correction Period, remove finished surfacing, backfill with additional approved material, compact, and reconstruct surfacing prior to further construction.
 1. Restore appearance, quality, and condition of finished surfacing to match adjacent work, and eliminate evidence of restoration to the greatest extent possible.

3.27 DISPOSAL OF SURPLUS SOIL AND WASTE MATERIALS

- A. Waste Material:
 1. Remove unsatisfactory soil, trash, and debris, and legally dispose off the Owner's property.
- B. Surplus Satisfactory Soil:
 1. Remove satisfactory soil, and legally dispose of it off the owner's property.
- C. Surplus Topsoil:
 1. Transport surplus topsoil to designated storage areas on the Owner's property, stockpile or spread topsoil as directed by the Owner.

- a. If stockpiled, the stockpile shall be neatly and uniformly graded with maximum 2:1 side slopes.
- b. The stockpile shall be seeded with a temporary grass cover crop at a minimum rate of four (4) pounds per 1000 square feet.

** END OF SECTION **

SECTION 280030 EROSION AND SEDIMENTATION CONTROL

PART 1 - GENERAL

1.1 SUMMARY

- A. This Section includes the following:
 - 1. Installation, maintenance and removal of temporary soil erosion and sedimentation control measures.
 - 2. Installation and maintenance of permanent soil erosion and sedimentation control measures.
- B. Related Sections:
 - 1. Section 280010 “Site Clearing and Construction Layout”
 - 2. Section 280020 “Earthwork”
 - 3. Section 286010 “Storm Utility Drainage Piping and Structures”
 - 4. Section 284010 “Seeded Turf and Grasses”

1.2 SUBMITTALS

- A. Product data for erosion control mats and filter socks.
- B. Copies of correspondence with Department of Environmental Protection (DEP).

1.3 REGULATORY COMPLIANCE

- A. The Clean Streams Law, Act of June 22, 1937, P.L.1987, as amended 35 P.S. 691.1 et. seq. and Chapters 73, 91, 95, 99, 101, and 102 of Department of Environmental Resources regulations promulgated thereunder. Comply with the Federal NPDES (National Pollution Discharge Elimination System) regulations, including permit acquisition and permit renewal. Ensure spoil and / or borrow sites are permitted under NPDES.
- B. Environmental Compliance: Comply with applicable portions of federal, state and local environmental agency regulations pertaining to storm drainage and erosion/ sedimentation control systems.
- C. Municipal Compliance: Comply with local municipal regulations and standards pertaining to storm drainage and erosion/sedimentation control systems.

1.4 QUALITY ASSURANCE

- A. Provide erosion control methods in accordance with the approved ESC Plan and in accordance with requirements of authorities having jurisdiction and as described in these Specifications.

PART 2 – PRODUCTS

2.1 EROSION MATS

A. Products/Manufacturers: Provide products by one of the following:

1. East Coast Erosion Control, Tel. 1-800-582-4005, www.erosionblankets.com

2.2 COMPOST FILTER SOCK

A. Products/Manufacturers: Provide products by one of the following:

1. Siltsoxx by Filtrexx Tel: 440-926-8041, www.filtrexx.com .
2. Biosock by BioSolutions, Tel. 800-913-2420, www.newbiosolutions.com

PART 3 – EXECUTION

3.1 CONSTRUCTION SEQUENCE

A. Refer to Erosion and Sedimentation Control Plans for project Construction Sequence.

3.2 EROSION MATS

A. Install erosion mats as indicated on the drawings and in accordance with manufacturer's recommendations.

3.3 COMPOST FILTER SOCK

A. Install compost filter sock in accordance with manufacturer's recommendations.

3.4 SEEDING AND MULCHING

A. Upon completion of any earth disturbance activity or any stage or phase of an activity, apply seed and mulch.

B. Mulch: Place straw mulch on seeded areas immediately after seeding. Place straw mulch uniformly in a continuous blanket at a rate of 3 tons per acre. On steep slopes, straw may be crimped into soil by mechanical means. Thoroughly water mulch immediately after application.

C. Fertilization Required: Apply lime and fertilizer for all of the listed mixes as required to obtain a uniform erosion resistant perennial vegetative coverage. Lime and fertilizer should be applied at the following rates:

2 tons of agricultural limestone per acre
100 lbs. of nitrogen per acre
200 lbs. of P₂O₅ per acre

200 lbs. of K_2O per acre

1. Test soils per section 284010 Lawns and Grasses and the rates for limestone and fertilizer will be verified based upon the results of those tests prior to seeding and fertilization.

D. Hydroseeding - Apply mixture at the following rates:

1. Seed: 175 lbs./acre
2. Starter fertilizer: 220 lbs./acre
3. Wood cellulose fiber mulch: 4,000 - 6,000 lbs./acre
4. Limestone: Rate determined by soil test

** END OF SECTION **

SECTION 280040 EXCAVATION SUPPORT AND PROTECTION

PART 1 - GENERAL

1.1 SUMMARY

- A. This Section includes the following:
 - 1. Steel H-section (soldier) piles.
 - 2. Timber lagging.
 - 3. Steel sheet piles.
 - 4. Underpinning.
 - 5. Trench Boxes.

- B. Related Sections:
 - 1. Section 280030 “Erosion and Sedimentation Control for ESC requirements and regulatory compliance.
 - 2. Section 280020 “Earthwork” for utility trenching and backfill.

1.2 SUBMITTALS

- A. Layout drawings for excavation support system and other data prepared by, or under the supervision of a Professional Engineer registered in the Commonwealth of Pennsylvania. System design and calculations must be acceptable to the design professional and local authorities having jurisdiction.

1.3 QUALITY ASSURANCE

- A. Engineer Qualifications: A Professional Engineer legally authorized to practice in the Commonwealth of Pennsylvania, and experienced in designing and in providing engineering services for excavation support systems similar in extent required for this project.

- B. Supervision: Engage and assign supervision for the design and installation of excavation support systems to a Professional Engineer registered in the commonwealth of Pennsylvania.
 - 1. Submit name of engaged consultant and qualifying technical experience.

- C. Regulations: Comply with codes and ordinances of governing authorities having jurisdiction including, but not limited to, the Federal Construction Safety Act.

1.4 JOB CONDITIONS

- A. Before starting work, verify governing dimensions and elevations. Verify condition of adjoining properties. Take photographs to record any existing settlement or cracking of

structures, pavements, and other improvements. Prepare a list of such damages, verified by dated photographs, and signed by Contractor and others conducting investigation.

- B. Survey adjacent structures and improvements, employing a Licensed Land Surveyor or Professional Engineer licensed in the Commonwealth of Pennsylvania, establishing exact elevations at fixed points to act as benchmarks. Clearly identify benchmarks and record existing elevations. Locate datum level used to establish benchmark elevations sufficiently distant so as not to be affected by movement resulting from excavation operations.
- C. During excavation, re-survey benchmarks weekly, employing a licensed Land Surveyor or Professional Engineer licensed in the Commonwealth of Pennsylvania. Maintain an accurate daily log of surveyed elevations for comparison with original elevations. Promptly notify the design professional if changes in elevations occur or if cracks, sags, or other damage is evident.

1.5 EXISTING UTILITIES

- A. Protect existing active sewerage, drainage, water, gas, electricity and other utility services and structures. Pay for damages occurring as a result of non-compliance to this section.
- B. Notify municipal agencies and service utility companies having jurisdiction. Comply with requirements of governing authorities and agencies for protection, relocation, removal, and discontinuing of services, as affected by this work.

PART 2 - PRODUCTS

2.1 MATERIALS

- A. General: Provide adequate shoring and bracing materials which will support loads imposed. Materials need not be new, but should be in serviceable condition.
- B. Structural Steel: ASTM A 36.
- C. Steel Sheet Piles: ASTM A 328 or ASTM A 572.
- D. Timber lagging: Any species, rough-cut, mixed hardwood, nominal 3 inches thick, unless otherwise indicated. If wood is part of a shoring system near existing structures, use pressure treated materials or remove before placement of backfill.
- E. Trench Boxes: ASTM A 36 steel designed specifically for utility installation and able to withstand lateral earth and hydrostatic pressures.

PART 3 - EXECUTION

3.1 SHORING

- A. Protect structures, utilities, sidewalks, pavements, and other facilities from damage caused by settlement, lateral movement, undermining, washout, and other hazards that could develop during excavation support and protection system operations.
 - 1. Shore, support, and protect utilities encountered.
- B. Install excavation support and protection systems to ensure minimum interference with roads, streets, walks, and other adjacent occupied and used facilities.
 - 1. Do not close or obstruct streets, walks, or other adjacent occupied or used facilities without permission from Owner and authorities having jurisdiction. Provide alternate routes around closed or obstructed traffic ways if required by governing regulations.
- C. Wherever shoring is required, locate the system to clear permanent construction and to permit forming and finishing of concrete surfaces. Provide shoring system adequately anchored and braced to resist earth and hydrostatic pressures.
- D. Shoring systems retaining earth on which the support or stability of existing structures is dependent must be left in place at completion of work.
- E. Monitor excavation support and protection systems daily during excavation progress and for as long as excavation remains open. Promptly correct bulges, breakage, or other evidence of movement to ensure excavation support and protection systems remain stable.

3.2 SOLDIER BEAMS AND LAGGING

- A. Install steel soldier piles before starting excavation. Space soldier piles at intervals indicated. Accurately align exposed faces of flanges to vary not more than 2 inches (50 mm) from a horizontal line and not more than 1:120 out of vertical alignment.
- B. Install wood lagging within flanges of soldier piles as excavation proceeds. Trim excavation as required to install lagging. Fill voids behind lagging with soil, and compact.
- C. Install wales horizontally at centers indicated and secure to soldier piles.

3.3 SHEET PILING

- A. Install one-piece sheet piling and tightly interlock to form a continuous barrier. Accurately align exposed faces of sheet piling to vary not more than 2 inches (50 mm) from a horizontal line and not more than 1:120 out of vertical alignment. Cut tops of sheet piling to uniform elevation at top of excavation.

3.4 TIEBACKS

- A. Drill for, install, tension, and grout tiebacks into position. Test load-carrying capacity of each tieback and replace and retest deficient tiebacks.

3.5 BRACING

- A. Locate bracing to clear pipes, utility structures, and other permanent work. If necessary to move a brace, install new bracing prior to removal of original brace.
- B. Do not place bracing where it will be cast into or included in permanent concrete work, except as otherwise acceptable to the design professional.
- C. Install internal bracing, if required, to prevent spreading or distortion of braced frames.
- D. Maintain bracing until structural elements are supported by other bracing or until permanent construction is able to be backfilled and to withstand lateral earth and hydrostatic pressures.
- E. Remove sheeting, shoring, and bracing in stages to avoid disturbance to underlying soils and damage to structures, pavements, facilities, and utilities.
- F. Repair or replace, as acceptable to the design professional, adjacent work damaged or displaced through installation or removal of shoring and bracing work.

3.6 TRENCH BOXES

- A. Provide trench boxes of adequate size and configuration to provide proper support and protection for the particular utility installation.
- B. Do not use stacked trench boxes unless they are specifically designed to be staked and to withstand lateral earth and hydrostatic pressures in a stacked configuration.
- C. Boxes may be advanced in the trench only after utilities have been properly compacted and backfilled at least one (1) foot above the top of the pipe. Take care in sliding the box forward so as to not disturb completed utility installations and to prevent the trench from collapsing.

3.7 REMOVAL AND REPAIRS

- A. Remove excavation support and protection systems when construction has progressed sufficiently to support excavation and bear soil and hydrostatic pressures. Remove in stages to avoid disturbing underlying soils and damaging structures, pavements, facilities, and utilities.
 - 1. Remove excavation support and protection systems to a minimum depth of 48 inches (1200 mm) below overlying construction and abandon remainder.
 - 2. Repair or replace, adjacent work damaged or displaced by removing excavation support and protection systems.
- B. Leave excavation support and protection systems permanently in place.

** END OF SECTION **

**SECTION 281010
HOT-MIX ASPHALT PAVING**

PART 1 - GENERAL

1.1 SUMMARY

- A. This Section includes the following:
 - 1. Proof rolling of prepared base.
 - 2. Hot-mixed asphalt paving.

- B. Related Sections:
 - 1. Section 280010 “Site Clearing and Construction Layout” for general construction layout and demolition of existing paving.
 - 2. Section 280030 “Erosion and Sedimentation Control” for ESC requirements and regulatory compliance.
 - 3. Section 280020 “Earthwork” for subgrade preparation.

1.2 SUBMITTALS

- A. Contractor Qualifications.

- B. Manufacturer Qualifications.

- C. Material Certificates signed by material producer and Contractor, certifying that each material item meets specified requirements.

1.3 QUALITY ASSURANCE

- A. Installer Qualifications: Engage an experienced installer who has completed hot-mix asphalt paving similar in material, design, and extent to that indicated for this Project and with a record of successful in-service performance of not less than five (5) years.

- B. Manufacturer Qualifications: Engage a firm experienced in manufacturing hot-mix asphalt similar to that indicated for this Project and with a record of successful in-service performance of not less than five (5) years.

- C. PennDOT Specifications: Comply with PennDOT Form 408 Specifications latest edition unless otherwise specified.

- D. Pre-Installation Conference: Conduct a meeting between the Prime/General Contractor, Sub-Contractors, Owner, Testing Agency and the Design Professional to review the scope of work in this section, coordination with other work, special project conditions and quality standards. Notify all parties and schedule the meeting a minimum of two (2) weeks prior to the anticipated start of the work specified under this Section.

1. Review proposed sources of paving materials, including capabilities and location of plant that will manufacture hot-mix asphalt.
2. Review condition of substrate and preparatory work performed by other trades.
3. Review requirements for protecting paving work, including restriction of traffic during installation period and for remainder of construction period.
4. Review and finalize construction schedule for paving and related work. Verify availability of materials, paving Installer's personnel, and equipment required to execute the Work without delays.
5. Review inspection and testing requirements, governing regulations, and proposed installation procedures.
6. Review forecasted weather conditions and procedures for complying with unfavorable conditions.

1.4 SITE CONDITIONS

- A. Apply prime and tack coats when ambient temperature is above 40 deg F (4 deg C) and when temperature has not been below 35 deg F (1 deg C) for 12 hours immediately prior to application. Do not apply when base is wet or contains an excess of moisture.
- B. Place hot-mixed base course when the atmospheric temperature is above 35 deg F (1 deg C) and when the aggregate base is dry. Do not place hot-mixed base course between October 31 and April 1.
- C. Place hot-mixed asphalt surface course when atmospheric temperature is above 40 deg F (4 deg C) and when base is dry. Do not place hot-mixed surface between October 31 and April 1.
- D. Grade Control: Establish and maintain required lines and elevations.
- E. Asphalt Paving: Paving work shall be limited to normal working hours of construction at the project.

PART 2 - PRODUCTS

2.1 MATERIALS

- A. General: Use locally available materials and gradations that exhibit a satisfactory record of previous installations. Product and source are required to be currently approved by PennDOT. The use of blast furnace slag as outlined in PennDOT Form 408 is prohibited.
- B. Coarse Aggregate: Sound, angular crushed stone, crushed gravel, complying with ASTM D 692-88 and PennDOT Publication 408, Section 703.2.
- C. Fine Aggregate: Sharp-edged natural sand or sand prepared from stone, gravel, or combinations thereof, complying with ASTM D 1073 and PennDOT Publication 408, Section 703.1.

- D. Mineral Filler: Rock or slag dust, hydraulic cement, or other inert material complying with ASTM D 242.
- E. Asphalt Cement: ASTM D 3381 for viscosity-graded material: ASTM D 946 for penetration-graded material and PennDOT Publication 408, Section 702.
- F. Tack Coat: Emulsified Asphalt; ASTM D 977 and PennDOT Publication 408, Section 460.
- G. Asphalt Sealer (Hot applied): Asphalt Cement AC-20, AASHTO 226-80 for viscosity-graded material.
- H. Asphalt Sealer (Cold Applied): Quikrete Blacktop Repair No. 8630.

2.2 ASPHALT-AGGREGATE MIXTURE

- A. Provide plant-mixed, hot-laid asphalt-aggregate mixture complying with ASTM D 3515 and as indicated on the contract drawings.
- B. The asphalt mix shall be in accordance with PennDOT Publication 408, Section 305 and Section 401.
 - 1. Superpave Asphalt Mixtures.
- C. The asphalt mix design and material certificates shall be submitted for approval prior to mixing and delivery of Asphalt-Aggregate mixture to the job site.

PART 3 - EXECUTION

3.1 SURFACE PREPARATION

- A. General: Fine grade and remove loose material from compacted base surface immediately before applying herbicide treatment.
- B. Proof-roll prepared base surface to check for unstable areas and areas requiring additional compaction. Perform proof-rolling with a ten ton minimum roller or loaded tandem-axle dump truck, as directed. Do not proofroll subgrades occurring within two to three feet of the water table.
- C. Notify Design Professional of unsatisfactory conditions. Do not begin paving work until deficient subbase areas have been corrected and are ready to receive paving.

- D. The contact area between existing and new pavements shall be saw cut full depth of wearing course and binder course so as to be smooth and straight prior to commencement of paving. The contact area of the surface layer shall be a minimum of eighteen (18) inches wider than the base or as indicated in the construction details. The horizontal distance between concrete curbing shall be sufficient to allow room for compaction equipment to be used on all layers.
- E. Tack Coat: Apply to newly constructed base courses, existing oxidized asphalt and milled asphalt.
1. Distribute Rates:
 - a. New Hot-mix asphalt base : 0.02 gallons per square yard
 - b. Existing oxidized asphalt: 0.04 gallons per square yard
 - c. Existing milled asphalt: 0.08 gallons per square yard
- F. Asphalt Sealer: Apply to surfaces at joints of previously constructed asphalt or Portland cement concrete and at surfaces abutting or projecting into hot-mixed asphalt pavement.
1. Apply asphalt sealer to top surfaces of new hot-mixed asphalt abutting existing asphalt pavement. Apply uniform coat 6" wide centered over joint extending 3" parallel either side of joint, with neat edges.
 2. Apply asphalt sealer to top surfaces of joints formed by hot-mixed asphalt paving and rims of manholes, catch basins, water valves, etc.
 3. Apply uniform coat of sand or stone dust to exposed asphalt sealer upon completion.
 4. Exercise care in application of asphalt sealer to avoid smearing or staining of adjoining concrete and other surface and appurtenances.

3.2 PLACING MIX

- A. General: Place hot-mixed asphalt mixture on prepared surface, spread, and strike off. Comply with PennDOT requirements for minimum temperature in spreading the mixture. Place areas inaccessible to equipment by hand. Place each course to required grade, cross-section, and compacted thickness.
- B. Begin applying mix along centerline of crown for crowned sections and on high side of one-way slopes, unless otherwise indicated.
- C. Paving Placement: Place in strips in widest strip practical. After first strip has been placed and rolled, place succeeding strips and extend rolling to overlap previous strips. Complete base course for an entire section before placing surface course.
- D. Regulate paver machine speed to obtain smooth, continuous surface free of pulls and tears in asphalt-paving mat.
- E. Correct irregularities in base course by placing leveling material or removing excess material forming high spots where required. Prior to placing the wearing course, examine the binder course for depressions, high spots and unstable areas. Fill depressions with bituminous leveling material. The Owner reserves the right to order

proof-rolling of binder course under his observation. Unstable areas shall be reconstructed including removal, replacement and compaction of unstable material.

- F. Immediately correct surface irregularities in finish course behind paver. Remove excess material forming high spots with shovel or lute. Fill depressions with hot-mix and smooth surface. Finish paving shall be free and even, and free of low spots or bumps. All areas must drain to established drainage points. No puddles will be permitted.
- G. Patching: Remove and replace paving areas mixed with foreign materials and defective areas. Cut out such areas and fill with fresh, hot-mixed asphalt. Compact by rolling to specified surface density and smoothness. The faces and surface edges of all patches adjacent to the existing pavement shall be sealed with hot applied asphalt joint sealer conforming to ASTM D 3405 within 5 working days. The cross-section of the patch shall be finished to match the existing cross-section of the roadway.

3.3 JOINTS

- A. Construct joints to ensure continuous bond between adjoining paving sections. Construct joints free of depressions with same texture and smoothness as other sections of hot-mix asphalt course.
 - 1. Clean contact surfaces and apply tack coat.
 - 2. Offset longitudinal joints in successive courses a minimum of 6 inches (150 mm).
 - 3. Offset transverse joints in successive courses a minimum of 24 inches (600 mm).
 - 4. Construct transverse joints by bulkhead method or sawed vertical face method.
 - 5. Compact joints as soon as hot-mix asphalt will bear roller weight without excessive displacement.
 - 6. Compact asphalt at joints to a density within 2 percent of specified course density.
 - 7. If cold joints occur, provide appropriate heating apparatus to heat existing asphalt to provide continuous bond.

3.4 COMPACTION

- A. General: Begin rolling when mixture will bear roller weight without excessive displacement. Complete compaction before mix temperature cools to 185 deg F (85 deg C).
- B. Compact mixture with hot-hand tampers or vibrating plate compactors in areas inaccessible to rollers.
- C. Breakdown Rolling: Accomplish breakdown or initial rolling immediately following rolling of joints and outside edge. Check surface after breakdown rolling and repair displaced areas by loosening and filling, if required, with hot material.

- D. Second Rolling: Follow breakdown rolling as soon as possible, while mixture is hot. Continue second rolling until mixture has been evenly compacted to the following density requirements: 92% -95% of laboratory density.
- E. Finish Rolling: Perform finish rolling while mixture is still warm enough for removal of roller marks. Continue rolling until roller marks are eliminated and course has attained 95 percent laboratory density.
- F. Patching: Remove and replace paving areas mixed with foreign materials and defective areas. Cut out such areas and fill with fresh, hot-mixed asphalt. Compact by rolling to specified surface density and smoothness.
- G. Protection: After final rolling, do not permit vehicular traffic on pavement until it has cooled and hardened.
- H. Erect barricades to protect paving from traffic until mixture has cooled enough not to become marked.

3.5 FIELD QUALITY CONTROL

- A. Thickness: In-place compacted thickness, tested in accordance with ASTM D 3549, will not be acceptable if exceeding following allowable variations:
 - 1. Base Course: Plus or minus ½ inch.
 - 2. Surface Course: Plus or minus ¼ inch.
- B. Surface Smoothness: Test finished surface of each hot-mixed asphalt course for smoothness, using 10-foot straightedge applied parallel with and at right angles to centerline of paved area unless specified otherwise. Surfaces will not be acceptable if exceeding the following tolerances for smoothness:
 - 1. Base Course Surface: ¼ inch.
 - 2. Wearing Course Surface: 3/16 inch
- C. Check surface areas at intervals.

** END OF SECTION **

**SECTION 282010
CEMENT CONCRETE PAVEMENT**

PART 1 - GENERAL

1.1 SUMMARY

- A. This Section includes the following:
 - 1. Concrete Curbs.
 - 2. Concrete Walkways and Pavements.

- B. Related Sections:
 - 1. Section 280010 "Site Clearing and Construction Layout" for layout and coordination.
 - 2. Section 280030 "Erosion and Sedimentation Control for ESC requirements and regulatory compliance.
 - 3. Section 280020 "Earthwork" for subgrade preparation, grading and subbase course.
 - 4. Section 240020 "Cast-in-Place Concrete" for general applications of concrete.

1.2 SUBMITTALS

- A. Contractor's Qualifications.

- B. Product data and/or samples for proprietary materials and items.

- C. Design mixes for each class of concrete. Include revised mix proportions when characteristics of materials, project conditions, weather, test results, or other circumstances warrant adjustments.

- D. Laboratory test reports for evaluation of concrete materials and mix design tests.

1.3 QUALITY ASSURANCE

- A. Concrete Standards: Comply with provisions of the following standards, except where more stringent requirements are indicated.
 - 1. All applicable ACI Publications.
 - 2. Concrete Reinforcing Steel Institute (CRSI) "Manual of Concrete Practice".

- B. Concrete Manufacturer Qualifications: Manufacturer of ready-mixed concrete products complying with ASTM C94 requirements for production facilities and equipment.

- C. Concrete Contractor's Qualifications: Firm regularly engaged in installing concrete pavement projects of similar size and scope as this project, with a minimum of seven (7) years experience. Provide a minimum of five (5) references of previous projects of like size and scope.

- D. Provide a sample pour showing all details such as finish, texture/pattern, color, joints, etc., for pavements and curbs. Provide a minimum of 100 square feet of walks and 20 LF of curbing. Upon approval, preserve the samples as the minimal standard for the project. The samples may be poured as part of the finished work, however, re-work will include all affected adjacent improvements at no additional cost to the owner.
- E. Pre-Installation Conference: Conduct a meeting between the Prime/General Contractor, Sub-Contractors, Owner, Testing Agency and the Design Professional to review the scope of work in this section, coordination with other work, special project conditions and quality standards. Notify all parties and schedule the meeting a minimum of two (2) weeks prior to the anticipated start of the work specified under this Section.
 - 1. Review requirements for submittals, status of coordinating work, availability of materials.
 - 2. Review detailed requirements for preparing concrete design mixes and determining procedures for satisfactory concrete operations.
 - 3. Establish preliminary work progress schedule and procedures for materials inspection, testing, and certifications.
 - 4. Review methods of assuring quality control will conform to contract documents.
 - 5. Require representatives of each entity directly concerned with cast-in-place concrete to attend conference.
- F. Make all provisions necessary, prior to placing of concrete, to assure adequate time for proper placing, finishing and curing based on the existing conditions at the job site.

1.4 PROJECT CONDITIONS

- A. Traffic Control: Maintain access for vehicular and pedestrian traffic as required for other construction activities.
- B. Utilize flagmen, barricades, warning signs, and warning lights as required to protect concrete installations from damage and to assure the safety of vehicular and pedestrian traffic.

PART 2 - PRODUCTS

2.1 FORMS

- A. Steel or other suitable material of size and strength to resist movement during concrete placement and to retain horizontal and vertical alignment until removal. Use straight forms, free of distortion and defects.
 - 1. Use flexible or curved forms for curves of a one hundred foot (100') or less radius. Straight, non-flexible forms are not permitted for use in providing smooth, continuous curves.

- B. Form Release Agent: Provide commercial formulation form-release agent with a maximum of 350 mg/l volatile organic compounds (VOCs) that will not bond with, stain, or adversely affect concrete surfaces and will not impair subsequent treatments of concrete surfaces.

2.2 REINFORCING MATERIALS

- A. Reinforcing Bars and Tie Bars: plain steel bars, ASTM A 775/A 775M based on ASTM A615 & AASHTO M 31, Grade 60, Deformed
- B. Plain, Cold-Drawn Steel Tie Wire: ASTM A 82 and AASHTO M 32.
- C. Welded Steel Wire Reinforcement: ASTM A 185 and AASHTO M 55.
 - 1. Furnish in flat sheets, not rolls.
- D. Supports for Reinforcement: Use wire bar-type supports complying with CRSI Specifications.
- E. Dowel Bars: ASTM A 775/A 775M; with ASTM A 615/A 615M, Grade 60 round bars; epoxy coated or galvanized (Class I coating after fabrication).
- F. Dowel Sleeves: Speed Dowel by Sika Greenstreak or approved equal.

2.3 JOINT MATERIALS

- A. Joint Filler: Provide preformed resilient bituminous per ACI 504R, AASHTO M 213.
- B. Joint Sealer:
 - 1. Applicable Standards: For Elastomeric Sealants: Federal Specification TT-S-00227E, Class A, Type II; ASTM C-920, Type S, Grade NS, Class 50, Use T,NT; ASTM C719; ASTM C 794.
 - a. Dynatrol II by Pecora Corporation.
 - b. Sikaflex – 2c NS TG, NS/SL by Sika.
 - c. Sonneborn NP-2, by Chemrex Inc.
 - 2. Color to match concrete.
- C. Backing Material:
 - 1. Provide sealant backings of material and type that are non-staining; are compatible with joint substrates, sealants, primers, and other joint fillers; and are approved for applications indicated by sealant manufacturer based on field experience and laboratory testing.
 - 2. Elastomeric Tubing Sealant Backings: Neoprene, butyl, EPDM, or silicone tubing complying with ASTM D 1056, nonabsorbent to water and gas, and capable of remaining resilient at temperatures down to minus 26 deg F (minus 32

deg C). Provide products with low compression set and of size and shape to provide a secondary seal, to control sealant depth, and to otherwise contribute to optimum sealant performance.

- D. Expansion Joint Cap: Provide pre-formed plastic expansion joint cap, Sealtight snap-cap as manufactured by W.R. Meadows, or approved equal.

2.4 CONCRETE MATERIALS

- A. Portland Cement: ASTM C150, ACI 325.9R.
 - 1. Use one brand of cement and same ready-mix supplier throughout Project.
- B. Normal-Weight Aggregates: ASTM C-33 and as follows. Provide aggregates from a single source. Product and source are also required to be currently approved by PADOT.
 - 1. Fine Aggregates: Type A per PADOT Publication 408, Section 703.1.
 - 2. Course Aggregates: Type A, AASHTO No. 57 per PADOT Publication 408, Section 703.2 and per PADOT Publication 408, Section 720.
 - 3. Do not use fine or coarse aggregates that contain substances that cause spalling.
 - 4. Course Aggregates for slip-form curb machines: maximum ½ inch.
- C. Water: Potable.

2.5 ADMIXTURES

- A. Provide concrete admixtures that contain not more than 0.1 percent by weight chloride ions.
- B. Air-entraining Admixture: ASTM C 260 and AASHTO M 154, certified by manufacturer to be compatible with other admixtures.
- C. Water-Reducing Admixture: ASTM C494, Type A and AASHTO M 194, Type A.
- D. High-Range Water-Reducing Admixture: ASTM C494, Type F or G and AASHTO M 194, Type F or Type G.
- E. Water-Reducing and Accelerating Admixture: ASTM C494, Type E and AASHTO M 194, Type E.
- F. Water-Reducing and Retarding Admixture: ASTM C494, Type D and AASHTO M 194, Type D.

2.6 CONCRETE MIX

- A. Prepare design mixes for each type and strength of normal-weight concrete by either laboratory trial batch or field experience methods as specified in applicable ACI 211.1, ASTM C 94 and AASHTO-M157. For the trial batch method, use a qualified independent testing agency for preparing and reporting proposed mix designs.

1. Do not use the Owner's field quality-control testing agency as the independent testing agency.
 2. Limit use of fly ash to twenty percent (20%) of cement content by weight.
- B. Proportion mixes to provide normal - weight concrete with the following minimum properties:
1. Compressive Strength (28-Day): Class AA 3750 psi for exposed concrete.
 2. Maximum Water-Cement Ratio at Point of Placement: 0.50.
 3. Slump Limit at Point of Placement: Four inches (4") for Class AA Concrete.
- C. Add air-entraining admixture at manufacturer's prescribed rate to result in concrete at point of placement having an air content as follows with a tolerance of plus or minus one and one-half percent (1- ½ %): ASTM C-260
1. Air Content: Six and one-half percent (6.5%) for one inch (1") maximum aggregate.

2.7 CONCRETE MIXING

- A. Ready-Mixed Concrete: ASTM C 94 and AASHTO M 157.
1. When air temperature is between eighty-five and ninety degrees Fahrenheit (85° - 90° F.), reduce mixing and delivery time from one and one-half (1- ½) hours to seventy-five (75) minutes; when air temperature is above ninety degrees Fahrenheit (90° F.), reduce mixing and delivery time to sixty (60) minutes.

2.8 CONCRETE EVAPORATION RETARDANT

- A. Water-based evaporation retardant: ACI 302.
1. Aquafilm by Conspec Marketing and Manufacturing Co., Inc.
 2. Evapre by W.R. Meadows
 3. Eucobar by Euclid Chemical Company

2.9 CONCRETE CURING MATERIALS

- A. Water-Based Membrane-Forming Curing Compound: ASTM C 309, Type 1, Classes A & B; ASTM C 1315; ACI 308; and AASHTO M 148, Type I, Classes A & B.
1. Kure-N-Seal WB by Sonneborn Building Products, Chemrex, Inc.
 2. Vocomp 25 by W.R. Meadows
 3. Cure & Seal WB by Conspec Marketing and Manufacturing Co., Inc.

2.10 MISCELLANEOUS MATERIALS

- A. Concrete bonding agent: ASTM C-1059, Type 1 or 2.
1. Strong Bond by Conspec Marketing and Manufacturing Co., Inc.

2. Intralok by W.R. Meadows
 3. Liquid Adhesive Bond by Euclid Chemical Company
- B. Epoxy Adhesive: ASTM C 881 and AASHTO M 235, two-component material suitable for dry or damp surfaces. Provide material type, grade, class and color to suit requirements.

PART 3 - EXECUTION

3.1 SURFACE PREPARATION

- A. Proof-roll prepared subbase surface to check for unstable areas and verify need for additional compaction to meet requirements specified in 280020, Earthwork. Do not begin placing concrete until such conditions have been corrected and are ready to receive the concrete.
- B. Remove loose material from compacted subbase surface immediately before placing concrete.

3.2 EDGE FORMS AND SCREED CONSTRUCTION

- A. Set, brace, and secure edge forms, bulkheads, and intermediate screed guides for paving to required lines, grades, and elevations. Install forms to allow continuous progress of work and so that forms can remain in place at least twenty-four (24) hours after concrete placement.
- B. Check completed formwork and screeds for grade and alignment to following tolerances:
 1. Top of Forms: Not more than one-eighth inch (1/8") in ten feet (10').
 2. Vertical Face on Longitudinal Axis: Not more than three-sixteenth inch (3/16") in ten feet (10').
- C. Clean forms after each use and coat with form release agent as required ensuring separation from concrete without damage.

3.3 PLACING REINFORCEMENT

- A. General: Comply with Concrete Reinforcing Steel Institute's recommended practice for "Placing Reinforcing Bars" for placing and supporting reinforcement.
- B. Clean reinforcement of loose rust and mill scale, earth, ice, or other bond-reducing materials.
- C. Arrange, space, and securely tie bars and bar supports to hold reinforcement in position during concrete placement. Maintain minimum cover of reinforcement.

- D. Install welded wire reinforcement sheets in lengths as long as practicable. Lap adjoining pieces at least one full mesh and lace splices with wire. Offset laps of adjoining widths to prevent continuous laps in either direction.
- E. Install fabricated bar mats in lengths as long as practicable. Handle units to keep them flat and free of distortions. Straighten bends, kinks, and other irregularities or replace units as required before placement. Set mats for a minimum two inch (2") overlap to adjacent mats.

3.4 JOINTS

- A. General: Construct control, construction, and expansion joints true to line with faces perpendicular to surface plane of concrete. Construct transverse joints at right angles to the centerline, unless indicated otherwise.
 - 1. Provide control joints in the patterns indicated. In absence of details, uniform panels should not exceed four feet by four feet.
 - 2. When joining existing paving, place transverse joints to align with previously placed joint, unless indicated otherwise.
- B. Contraction Joints: Provide weakened-plane control joints as follows:
 - 1. Tooled Joints: Form control joints in fresh concrete by grooving and finishing each edge of joint with a ¼ inch radius groover.
 - 2. Saw cut Joints: For concrete curb, cut contraction joints in fresh concrete within six to eight (6-8) hours of placement. Saw cut 1/8" inch wide and one inch deep at ten foot (10') intervals. Saw cut joints are not permitted in concrete sidewalks and other flat work.
- C. Construction Joints: Set construction joints at side and end terminations of concrete and at locations where concrete operations are stopped for more than one-half (½) hour, unless concrete terminates at expansion joints.
 - 1. Continue new pour from score line location or isolation joint. Remove excess from previous pour that extends between designated joint lines.
 - 2. Use a bonding agent at locations where fresh concrete is placed against hardened or partially hardened and existing concrete surfaces.
- D. Expansion Joints: Form expansion joints of pre-formed joint filler strips abutting concrete curbs, catch basins, manholes, inlets, structure, utility poles, foundation walls, columns and where indicated.
 - 1. Locate expansion joints at maximum intervals of 50 feet in curb, and at 20 feet in flatwork unless indicated otherwise. Provide isolated expansion joints in slabs-on-grade at points of contact between slab and vertical surfaces such as utility poles, foundation walls, columns, etc., and as indicated.
 - 2. Furnish joint fillers in one-piece lengths for full width being placed wherever possible, where more than one length is required, and lace or clip joint filler sections together.

4. Extend joint fillers to full depth of joint, not less than 1/2 inch or more than 3/4 inch below finished surface where joint sealant is indicated.
5. Protect top edge of joint filler during concrete placement with an expansion joint cap. Remove cap after concrete has been placed on both sides of joint, providing not less than 1/2 inch or more than 3/4 inch below finished surface. Clean joint of all foreign debris, particles, etc. with compressed air or similar method.
6. At non-supported edges of pavement, provide a temporary form to support full, uniform depth of sealant.
7. Install dowel and sleeve assembly where indicated. Grease one end of dowel to be inserted into sleeve.

E. Joint Sealants:

1. Employ only proven installation techniques which will ensure that sealants are deposited in uniform, continuous ribbons without gaps or air pockets, with complete “wetting” of joint bond surfaces equally on opposite sides. Except as otherwise indicated, fill sealant rabbet to a slightly concave surface, slightly below adjoining surfaces. Where horizontal joints are between a horizontal surface and vertical surfaces, fill joint to form a slight cove, so that joint will not trap moisture and dirt.
2. Cure sealants and caulking compounds in compliance with manufacturer’s instructions and recommendations, to obtain high early body strength, internal cohesive strength and surface durability. Cure and protect sealants, concrete, etc. from damage during construction activities, so that they will be without deterioration or damage (other than normal wear and weathering) at time of substantial completion. Replace or restore sealants which are damaged or deteriorated during construction period.

3.5 CONCRETE PLACEMENT

- A. Inspection: Before placing concrete, inspect and complete formwork installation, reinforcing steel, and items to be embedded or cast in. Notify other trades to permit installation of their work.
- B. Remove snow, ice, or frost from subbase surface and reinforcing before placing concrete. Do not place concrete on surfaces that are frozen.
- C. Moisten subbase to provide a uniform dampened condition at the time concrete is placed. Do not place concrete around manholes or other structures until they are at the required finish elevation and alignment.
- D. Comply with requirements of AASHTO M 157, ACI 325.9R for measuring, mixing, transporting, and placing concrete.
- E. Deposit and spread concrete in a continuous operation between transverse joint. Do not push or drag concrete into place or use vibrators to move concrete into place.
 1. When concrete placing is interrupted for more than one-half (1/2) hour, place a construction joint.

2. Support expansion joint filler with temporary rigid backerboard on the opposite side from the pour, capable of maintaining straight joint lines, in proper alignment with adjacent joint lines of the slab.
- F. Use a bonding agent at locations where fresh concrete is placed against hardened or partially hardened concrete surfaces.
- G. Use equipment and procedures to consolidate concrete complying with AASHTO M 157, ACI 325.9R.
1. Consolidate concrete along face of forms and adjacent to transverse joints with an internal vibrator. Keep vibrator away from joint assemblies, reinforcement, or side forms. Use only square-faced shovels for hand-spreading consolidation. Consolidate with care to prevent dislocating reinforcing, dowels, and joint devices.
- H. Screed paved surfaces with a straightedge and strike off. Use bull floats or darbies to form a smooth surface plane before excess moisture or bleed water appears on the surface. Do not further disturb concrete surfaces prior to beginning finishing operations.
- I. Slip-form Curbs: When automatic machine placement is used for curbs, submit revised mix design and laboratory test results that meet or exceed requirements. Design revised mix in accordance with ACI 211.1 and 211.2, specifically for slip-form curb machines while producing a curb which holds its shape, grade, strength and finish as required. Maximum size of course aggregates for slip-form curb machines is one-half (1/2) inch. Produce curbs and gutters to required cross section, lines, grades, finish, and jointing as specified for formed concrete. If results are not acceptable, remove and replace with formed concrete.
- J. Cold-Weather Placement: Comply with provisions of ACI 306R, and AASHTO M 157, and as follows: Protect concrete work from physical damage or reduced strength that could be caused by frost, freezing actions, or low temperatures.
1. Do not use calcium chloride, salt, or other materials containing antifreeze agents or chemical accelerators unless otherwise accepted in mix designs.
- K. Hot-Weather Placement: Comply with provisions of ACI 305R and AASHTO M 157, when hot weather conditions exist.
1. Cover reinforcing steel with water-soaked burlap if it becomes too hot, so that steel temperature will not exceed the ambient air temperature immediately before embedding in concrete.
 2. Fog spray forms, reinforcing steel, and subgrade just before placing concrete. Keep subgrade moisture uniform without standing water, soft spots, or dry areas.

3.6 CONCRETE FINISHING

- A. Do not begin finishing operations until all free water has been evaporated or removed.

- B. Float Finish: Begin floating when bleed water sheen has disappeared and the concrete surface has stiffened sufficiently to permit operations. Float surface with power-driven floats, or by hand-floating if area is small or inaccessible to power units. Finish surfaces to true planes within a tolerance of one-eighth inch (1/8") in ten feet (10') as determined by a ten foot (10') long straightedge placed anywhere on the surface in any direction. Cut down high spots and fill low spots. Re-float surface immediately to a uniform granular texture.
 - 1. Medium-to-Fine-Textured Broom Finish: Draw a soft bristle broom across concrete surface perpendicular to line of traffic to provide a uniform fine line texture finish.
- C. Final Tooling: Tool edges of paving, gutters, curbs, and joints formed in fresh concrete with a one-fourth inch (1/4") radius jointing tool. Repeat tooling of edges and joints after applying surface finishes. Eliminate tool marks on concrete surfaces.

3.7 PAVEMENT TOLERANCES

- A. Comply with tolerances of ACI 117, ACI 330.1 and as follows:
 - 1. Elevation: 1/4 inch.
 - 2. Thickness: Plus 3/8 inch, minus 1/4 inch.
 - 3. Surface: Gap below 10-foot- long, unleveled straightedge not to exceed 1/4 inch.
 - 4. Joint Spacing: 3 inches.
 - 5. Contraction Joint Depth: Plus 1/4 inch, no minus.
 - 6. Joint Width: Plus 1/8 inch, no minus.

3.8 CONCRETE PROTECTION AND CURING

- A. General: Protect freshly placed concrete from premature drying and excessive cold or hot temperatures. Comply with the recommendations of ACI 306R for cold weather protection and ACI 305R for hot weather protection during curing. Be prepared to protect freshly placed concrete from rain.
- B. Evaporation Control: In hot, dry, and windy weather, protect concrete from rapid moisture loss before and during finishing operations with an evaporation-control material. Apply according to manufacturer's instructions after screeding and bull floating, but before floating.
- C. Begin curing after finishing concrete but not before free water has disappeared from concrete surface.
- D. Curing Methods: Cure concrete using one of the following methods or a combination thereof:
 - 1. Moisture Curing: Keep surfaces continuously moist for not less than seven (7) days with the following materials:
 - a. Water
 - b. Continuous Water-Fog Spray

- c. Absorptive cover, water saturated, and kept continuously wet. Cover concrete surfaces and edges with a twelve inch (12”) lap over adjacent absorptive covers.
 - 2. Moisture-Retaining-Cover Curing: Cover concrete surfaces with moisture-retaining cover, placed in widest practicable width, with sides and ends lapped at least 12 inches and sealed by waterproof tape or adhesive. Immediately repair any holes or tears occurring during installation or curing period using cover material and waterproof tape.
 - 3. Curing Compound: Apply uniformly in continuous operation by power spray or roller according to manufacturer’s directions. Recoat areas subjected to heavy rainfall within three (3) hours after initial application. Maintain continuity of coating and repair damage during curing period. Do not use curing compound where concrete surface is intended for mortar setting beds – provide alternate curing methods.
- E. Protect freshly placed concrete from accidental traffic and from deliberate damage such as initials and graffiti.

3.9 BACKFILLING

- A. After curing, remove debris from pavement edges and backfill the adjoining areas with topsoil. Grade topsoil flush with finished concrete surface and conform to the surrounding area in accordance with the lines and grades indicated.

3.10 FIELD QUALITY CONTROL TESTING

- A. The Owner reserves the right to sample and test concrete using a qualified Testing Agency.
- B. Provide notice to Owner of dates when concrete work will commence and allow access for sampling.

3.11 REPAIRS AND PROTECTION

- A. Remove and replace concrete paving that is broken, damaged, or defective, or does not meet the requirements of this Section.
- B. Protect concrete from damage. Exclude traffic from paving for at least twenty-eight (28) days after placement. When construction traffic is permitted, maintain paving as clean as possible by removing surface stains and spillage of materials as they occur.
- C. Maintain concrete paving free of stains, discoloration, dirt, and other foreign material. Sweep concrete paving just prior to final inspection.

** END OF SECTION **

**SECTION 283010
UNIT PAVERS**

PART 1 - GENERAL

1.1 SUMMARY

- A. This Section includes the following:
 - 1. Unit pavers on sand setting bed.
- B. Related Sections:
 - 1. Section 280030 “Erosion and Sedimentation Control for ESC requirements and regulatory compliance.
 - 2. Section 280020 “Earthwork” for compacted sub-grade under unit pavers.
 - 3. Section 282010 “Cement Concrete Paving” for cast-in-place concrete curbs and gutters serving as edge restraint for unit pavers.

1.2 SUBMITTALS

- A. Material certificates:
 - 1. Setting bed sand.
 - 2. Joint sand.
- B. Installer’s Qualifications.

1.3 QUALITY ASSURANCE

- A. Installer Qualifications: Engage an installer having skilled craftsmen or individuals with a minimum of seven (7) years experience who has successfully completed paver installations similar in material, design, and extent to that indicated for Project.

1.4 DELIVERY, STORAGE, AND HANDLING

- A. Protect unit pavers and aggregate during storage and construction against wetting by rain, snow, or ground water and against contamination from earth and other materials.

1.5 PROJECT CONDITIONS

- A. Cold-Weather Protection: Do not use frozen materials or materials mixed or coated with ice or frost. Do not build on frozen sub-grade or setting beds. Remove and replace unit paver work damaged by frost or freezing.

PART 2 - PRODUCTS

2.1 UNIT PAVERS

- A. Salvage, clean and re-use existing pavers where indicated. Stockpile and cover until re-setting. Provide matching unit pavers if existing quantity is not sufficient. Replace broken, chipped or otherwise damaged pavers with matching units.

2.2 SETTING MATERIALS

- A. Sand for Leveling Course: Fine, sharp, non-plastic aggregate complying with ASTM C33.
- B. Sand for Joints: Fine, sharp, non-plastic aggregate complying with ASTM C33 or ASTM C144.

2.3 EDGE RESTRAINTS

- A. Concrete Curb: Refer to Section 282010 Cement Concrete Paving.

PART 3 - EXECUTION

3.1 EXAMINATION

- A. Examine surfaces indicated to receive paving, with installer present, for compliance with requirements for installation tolerances and other conditions affecting performance of unit pavers. Do not proceed with installation until unsatisfactory conditions have been corrected.

3.2 PREPARATION

- A. Clean substrates to remove dirt, dust, debris, and loose particles.

3.3 INSTALLATION - GENERAL

- A. Do not use unit pavers with chips, cracks, voids, discolorations, and other defects that might be visible in finished work.
- B. Cut unit pavers with motor-driven masonry saw equipment to provide clean, sharp, un-chipped edges. Cut units to provide pattern indicated and to fit adjoining work neatly. Use full units without cutting where possible. Hammer cutting is not acceptable.
- C. Joint Pattern: Match joint pattern of existing unit pavers.
- D. Tolerances: Do not exceed 1/16-inch unit-to-unit offset from flush and a tolerance of 1/8 inch in 2'-0" and 1/4 inch in 10'-0" from level or slope as indicated, for finished surface of paving.

3.4 SETTING PAVERS

- A. Place leveling course sand and screed to uniform thickness, taking care that sand remains dry density is loose and constant until concrete pavers are set.
- B. Set pavers with hand-tight joints, being careful not to disturb leveling base. If pavers have spacer bars, then place pavers hand tight against spacer bars. Use string lines to keep straight lines and maintain pattern. Fill gaps between units that exceed 3/16 inch with pieces cut to fit from full-size unit pavers.
- C. Vibrate pavers into leveling course with a low amplitude plate vibrator capable of a 3,500 to 5,000 pound compaction force. Perform at least 3 passes across paving with vibrator. Place protective mats or membrane over paver surface prior to operating plate vibrators to prevent scuffing. Vibrate under the following conditions:
 - 1. After edge pavers are installed and there is a completed surface or before surface is exposed to rain.
 - 2. Before ending each day's work, fully compact installed concrete pavers within 3 feet of the laying face. Cover the open layers with non-staining plastic sheets overlapped 4 feet on each side of laying face to protect it from rain.
- D. Spread dry joint sand and fill joints immediately after vibrating pavers into leveling course. Brush and vibrate sand until joints are completely filled, then remove surplus sand.
- E. Do not allow any traffic on installed concrete pavers until sand has been vibrated into joints.
- F. Provide final protection and maintain conditions in a manner acceptable to installer, which ensures unit paver work being without damage or deterioration at time of Substantial Completion.

** END OF SECTION **

**SECTION 284010
SEEDED TURF AND GRASSES**

PART 1 - GENERAL

1.1 SUMMARY

- A. This Section includes the following:
 - 1. Topsoil Testing.
 - 2. Fine grading and preparing of turf areas.
 - 3. Furnishing and applying soil amendments.
 - 4. Furnishing and applying fertilizers.
 - 5. Seeding new turf areas.
 - 6. Replanting unsatisfactory or damaged turf.
 - 7. Maintenance.

- B. Related Sections:
 - 1. Section 280010 “Site Clearing” for protection of existing trees and plantings, topsoil stripping and stockpiling, and site clearing.
 - 2. Section 280030 “Erosion and Sedimentation Control” for ESC requirements and regulatory compliance, erosion control mats and silt fence.
 - 3. Section 280020 “Earthwork” for excavation, filling, rough grading, subsurface aggregate drainage, drainage backfill, and placement of topsoil.
 - 4. Section 285010 “Exterior Plants” for coordination.

1.2 WORK NOT INCLUDED

- A. Items of work excluded from this Section:
 - 1. Topsoil placement
 - 2. Excavation and grading to the subgrade.
 - 3. Fine grading and compaction of subgrade.

1.3 SUBMITTALS

- A. Installer’s Qualifications.

- B. Certification of Grass Seed: Submit seed vendor’s certified statement for each grass seed mixture required, stating botanical and common name, percentage by weight, and percentages of purity, germination, and weed seed for each grass seed species.

- C. Topsoil Analysis Report: Test on-site topsoil and imported topsoil using a qualified agronomist. Furnish soil analysis by a qualified soil-testing laboratory stating percentages of organic matter; gradation of sand, silt, and clay content; cation exchange capacity; deleterious material; pH; and mineral and plant-nutrient content of topsoil.

1. Report suitability of topsoil for turf growth. State recommended quantities of nitrogen, phosphorus, potash nutrients, other essential elements, and soil amendments to be added to produce satisfactory turfgrass growth.
2. Submit copies of test results and recommended soil amendments to the Design Professional for review and written response a minimum of 10 days prior to commencing work.
3. Essential Topsoil Nutrients: All topsoil (both on-site and new) for turf shall receive proper amendments so the following nutrients fall within the ideal range based on fertility tests of the topsoil receiving the turf seed:

Macronutrients	Micronutrients
pH	B
N	Fe
P	Mn
K	Cu
Ca	Mo
Mg	Zn
S	

- D. Imported Topsoil: Before delivery of imported topsoil, furnish the Design Professional with a written statement meeting the requirements of Article 2.1.
- E. Soil Amendments: Submit vendor's certification for each fertilizer, dry material, liquid and wettable amendment required. See Schedule of Soil Amendments and Fertilizers at the end of this section. Submit a minimum of ten (10) days prior to beginning work.
- F. Maintenance Instructions: Submit typewritten instructions recommending procedures to be established by Owner for maintenance of turf following substantial completion and subsequent acceptance of turf. Submit prior to expiration of the required maintenance period(s) when specified herein.
- G. Record Drawings: At Substantial Completion, provide a plan of the project site with an accompanying log depicting the following:
 1. Areas of seeding
 2. Soils analysis reports including date of test and locations
 3. Type of seed mixture
 4. Amendments applied
 5. Dates of application and seeding
 6. Dates and type of maintenance activities performed including mowing

1.4 QUALITY ASSURANCE

- A. Installer Qualifications.

1. The Installer shall have been actively and directly engaged in installing and maintaining turf for a period of five (5) years or more, and provide proof of ten (10) or more installations completed by them which have been in use for three (3) or more years.
 - a. Include evidence and experience of skilled craftsmen or individuals who specialize in the handling, placement, and finishing the materials and products required for turf installation.
- B. Soil-Testing Laboratory: An independent laboratory, with the experience and capability to conduct the testing indicated and that specializes in types of tests to be performed.
- C. General: Ship landscape materials with certificates of inspection required by governing authorities. Comply with regulations applicable to landscape materials.
- D. Substitutions: Do not make unauthorized substitutions of materials. If specified material is not obtainable, submit proposal for use of equivalent material for approval.
- E. Analysis and Standards: Package standard products with manufacturer's certified analysis. For other materials, provide analysis by recognized laboratory made in accordance with methods established by the Association of Official Agriculture Chemists, wherever applicable.
- F. Pre-Installation Conference: Conduct a meeting between the Prime/General Contractor, Sub-Contractors, the Owner and the Design Professional to review the scope of work in this section, coordination with other work, special project conditions and quality standards. Notify all parties and schedule the meeting a minimum of two (2) weeks prior to the anticipated start of the work specified under this Section.
- G. Prior to initiating work, conduct whatever investigations necessary, including timely site visits, to ensure that areas are in compliance with requirements and other conditions affecting performance of work under this Section.
 1. Refer to Section 280020 Earthwork for such interfacing activities as establishment of grades, preparation of subsoil and provision of topsoil. Verify that subsoil and topsoil condition complies with requirements to the extent that no adverse growing conditions are present. Adverse conditions may include, but are not limited to, presence of construction debris, rock, toxic substances; overly compacted soils; shallow bedrock, improper grades, and/or inadequate depth of topsoil.
 2. Refer to Section 286010 Storm Utility Drainage Piping for implementation of stormwater controls. Verify that conditions comply with requirements to the extent that no adverse growing conditions are present. Adverse conditions may include, but are not limited to, improperly graded swales or channels, clogged inlets or subdrains or other factors contributing to standing water or poorly drained soils.
 3. Do not proceed with work until deficiencies are corrected. By proceeding, the installer is agreeing that conditions are acceptable for performance of the work covered under this Section.

1.5 DELIVERY, STORAGE AND HANDLING

- A. Packaged Materials: Deliver packaged materials in undamaged containers showing weight, analysis and name of manufacturer. Protect materials from deterioration during delivery, and while stored at site.

1.6 JOB CONDITIONS

- A. Planting Time: Sow turf seed only during normal planting seasons for each type of turf work required. Correlate planting time with maintenance schedule to provide required maintenance up to date of "Substantial Completion of turf".
- B. Proceed with and complete seeding work as rapidly as portions of site become available, working within seasonal limitations for each kind of seeding work required.
 - 1. Planting Time: Permanent grass to be seeded no later than May 15th for Spring seeding and only between August 1 and October 15 for Fall planting.
 - 2. Temporary grass seeding is required if areas are exposed for longer than 20 days or areas are not permanently established prior to the Winter season.
- C. Utilities: Determine locations of underground utilities and perform work in a manner which will avoid possible damage. Hand excavate, as required. Maintain grade stakes set by others until removal is mutually agreed upon by all parties concerned.
- D. Excavation: When conditions detrimental to plant growth are encountered, such as rubble fill, adverse drainage conditions, or obstructions, notify the Owner before seeding.
- E. Coordination with Turf: Trees and shrubs should be planted after final grades are established and prior to planting of turf, unless otherwise acceptable to the Owner. If planting of trees and shrubs occurs after turf work, protect turf areas and promptly repair damage to turf resulting from planting operations.

1.7 PROJECT MAINTENANCE

- A. Provide maintenance in accordance with Part 3 of this Section beginning immediately after planting and continuing until an acceptable lawn is established but not less than 60 days.

PART 2 - PRODUCTS

2.1 Topsoil:

- A. Stripping, storage, bulk placement of topsoil and imported topsoil is provided for in Sections 280030 and 280020. If depth of topsoil is not as specified notify Owner for directions prior to proceeding.
- B. Topsoil may be stockpiled for re-use in landscape work. If quantity or quality of stockpiled topsoil is insufficient, provide additional topsoil as required to complete landscape work at no additional cost to owner. Refer to 280020 Earthwork for imported topsoil requirements.

2.2 INORGANIC SOIL AMENDMENTS

- A. Commercially prepared products for specific use in the development of turf and grasses. Amendments to be incorporated into topsoil per soil analysis tests and recommendations by a qualified agronomist or testing agency may include but are not limited to the following: lime, sulfur, iron sulfate, perlite, agricultural gypsum, diatomaceous earth.
- B. Provide not less than the amendment quantities as determined by topsoil analysis test by a certified laboratory or agronomist.

2.3 FERTILIZER

- A. Commercially prepared products consisting of nitrogen, potassium and phosphorous for the purpose of providing essential levels of these elements for optimum growth and development of turf and grasses, as determined by topsoil analysis tests and recommendations of a qualified agronomist or testing agency; including but not limited to:
 - 1. Commercial fertilizer: Commercial-grade complete fertilizer of neutral character, consisting of fast- and slow-release nitrogen, 50 percent derived from natural organic sources of urea formaldehyde, phosphorous, and potassium in composition determined by qualified agronomist.
 - 2. Starter fertilizer: Granular or pelletized fertilizer consisting of 50 percent water-insoluble nitrogen, phosphorus, and potassium in composition determined by qualified agronomist.
 - 3. Superphosphate: Commercial, phosphate mixture, soluble; a minimum of 20 percent available phosphoric acid.
- B. Apply fertilizer in accordance with the recommendations of an experienced certified agronomy testing service hired by the contractor, and based upon site soil sample tests. Submit lab recommendations to the Owner for review.

2.4 SCHEDULE OF TURF GRASS SEED MIXTURES

- A. Grass Seed: Provide fresh, clean, new-crop seed complying with tolerance for purity and germination established by Official Seed Analysis of North America. Provide certified

seed of specified grass species, with proportions to meet minimum percentage of purity and germination.

- B. Full Sun – Verify seed mixture for site specific environmental and soil conditions:

Proportion By Weight	Common Name	Min. % Germ.
44.10%	Gateway Kentucky Bluegrass	85%
44.10%	Rendition RX Tall Fescue	85%
9.7%	Palmer III Perennial Ryegrass	90%
.02%	Other Crop Seed	
2.07%	Inert Matter	
.01%	Weed Seed	

Rate: 6.50 lbs./1,000 sq. ft.

- C. Temporary Cover Crop: Cutter or Sunshine Perennial Ryegrass or annual rye, dependent upon project conditions. Apply at the rate of six (6) pounds per 1,000 sq. ft.

- D. Shade Seed Mix – Available Genesis Turf Grass.

Proportion By Weight	Common Name	Min. % Germ.
24.25%	Ambrose Chewings Fescue	85%
19.40%	Viking H20 Hard Fescue	85%
14.55%	Epic Red Fescue	85%
14.55%	Red Fescue, Creeping Type	85%
14.55%	Wizard Perennial Ryegrass	90%
9.80%	Brooklawn Kentucky Bluegrass	85%
.03%	Other Crop Seed	
3.54%	Inert Matter	
.05%	Weed Seed	

Rate: 6 lbs/1000 sq. ft.

2.5 MISCELLANEOUS MATERIALS

- A. Wood Cellulose Fiber Mulch: Degradable green dyed wood cellulose fiber or 100% recycled long fiber pulp, free from weeds or other foreign matter toxic to seed germination and suitable for hydro-mulching.
- B. Straw Mulch: Provide clean, seed-free, threshed straw of wheat, rye, oats or barley.
- C. Tackifier: Liquid concentrate diluted with water forming a transparent 3-dimensional film-like crust permeable to water and air and containing no agents toxic to seed germination.

PART 3 - EXECUTION

3.1 SOIL PREPARATION AND GRADING

- A. Limit preparation to areas that will be planted in immediate future.
- B. Avoid any excessive heavy traffic over topsoil.
- C. If topsoil is hardened, loosen to a minimum depth of 4 inches. Mechanically and/or manually, remove stones larger than 1 inch in any dimension, sticks, roots, rubbish, and other extraneous matter throughout process of preparation prior to seeding.
- D. Clean topsoil of roots, plants, sods, stones, clay lumps, weeds, and other extraneous materials harmful or toxic to plant growth and legally dispose of such materials off- site.
- E. Operate rock-picking equipment at a controlled speed to allow thorough, efficient removal of all rocks and stones.
- F. Mix soil amendments and fertilizers with topsoil at rates specified by soil analysis. Delay mixing of fertilizer if planting will not follow placing of topsoil mixture within two days. Apply soil amendments on surface of spread topsoil and mix thoroughly into top 4 inches of topsoil before planting.
 - 1. Mix lime with dry soil before mixing in fertilizer.
 - 2. Apply phosphoric acid fertilizer (other than that constituting a portion of complete fertilizers) directly to subgrade before tilling.
- G. Re-grade, re-firm and rake the soil surface to establish the final surface so that it is uniform and free of irregularities.
- H. Fine grade turf areas to smooth, even surface with loose, uniformly fine texture. Roll, rake, and drag turf areas, remove ridges and fill depressions, as required to meet finish grades. Remove stones and extraneous matter and objects larger than 1" in any dimension and dispose. Limit fine grading to areas, which can be planted immediately after grading. Do not over-compact seeding media.
- I. Adjacent to paved surfaces and top edges of curbs, finish topsoil flush with edge of pavement or curb, within one-quarter inch, plus or minus.
- J. Restore turf areas to specified condition if eroded or otherwise disturbed after fine grading prior to planting.
- K. Preparation of Unchanged Grades: Where turf are to be planted in areas that have not been altered or disturbed by excavating, grading, or stripping operations, prepare soil for turf and grass planting as follows: Till to a depth of at least 6 inches. Apply soil amendments and initial fertilizers as specified and mix thoroughly into top 6 inches of soil. Remove high areas and fill in depressions eliminating irregularities. Till soil to a homogenous mixture of fine texture, free of lumps, clods, stones, roots, and other extraneous matter.

1. Before preparing of unchanged areas, remove existing grass, vegetation, and turf. Legally dispose of such material off of Owner's property; do not turn over into soil being prepared for turf.

3.2 SEEDING AND MULCHING NEW TURF

- A. Sow seed with a broadcast spreader or a seeding drill. When broadcasting, do not seed when wind velocity exceeds 5 miles per hour. Distribute seed evenly over entire area by sowing equal quantity in 2 directions at right angles to each other.
 1. Do not use wet seed or seed that is moldy or otherwise damaged in transit or storage.
 2. Sow no less than the quantity of seed specified.
- B. Protect seeded areas against erosion by spreading specified turf mulch after completion or in combination with seeding operations. Spread uniformly to form a continuous blanket. Spread by hand, blower, or other suitable equipment.
 1. Anchor mulch by application of a tackifier in accordance with manufacturer's recommendations. Take precautions to prevent damage or staining of structures or other plantings adjacent to mulched areas. Immediately clean such areas where damage occurs.
 2. Do not allow mulch to accumulate in concentrated areas ie. ponding from rain, wind, etc, throughout maintenance period.

3.3 RECONDITIONING TURF

- A. Recondition existing turf areas damaged by construction activity and where settlement or washouts occur or where minor regrading is required.
- B. Provide fertilizer, seed or sod, and soil amendments as specified for new turf and as required to provide satisfactorily reconditioned turf. Provide new planting soil as required to fill low spots and meet new finish grades.
- C. Cultivate bare and compacted areas to provide a planting bed depth of 6 inches.
- D. Remove diseased or unsatisfactory turf areas; do not bury into soil. Remove topsoil containing foreign materials resulting from construction activity including oil drippings, concrete and masonry waste, stone, gravel, and other construction materials; replace with new topsoil. Legally dispose of removed material off site.
- E. Where substantial turf remains (but is thin), mow, rake, aerate if compacted, fill low spots, remove humps, cultivate soil, fertilize, and seed. Remove weeds before seeding. If weeds are extensive, apply selective herbicides as required. Apply seedbed mulch, if required, to maintain moist condition.

3.4 PROTECTION

- A. Erect barricades and warning signs as required to protect newly planted areas from pedestrian and vehicular traffic. Maintain barricades throughout maintenance period until turf is accepted.

3.5 MAINTENANCE BY CONTRACTOR

- A. Begin maintenance of turf immediately after each area is planted and continue for the periods required to establish an acceptable turf, but no less than the following:
 - 1. Seeded turf: Provide a minimum of 3 mowings or, as many as necessary, and maintain as necessary until the day of Substantial Completion.
 - a. If seeded in Fall and not considered acceptable at that time, continue maintenance during following Spring until an acceptable turf is established.
- B. Provide the equipment and labor necessary to mow and irrigate all seeded areas until Acceptance. The Owner shall provide a source of water for irrigation.
- C. Maintain all turf by fertilizing, weeding, mowing and other operations such as rolling, regrading, re-seeding as required to establish a smooth, acceptable turf, free of eroded or bare areas. Remove all stones 1" and larger in any dimension and legally dispose of offsite.
- D. Re-mulch with new mulch in areas where mulch has been disturbed by wind, rain or maintenance operations sufficiently to nullify its purpose. Anchor as required to prevent displacement.
- E. Replant bare areas with same materials specified for turf.
- F. Mow turf as soon as there is enough top growth to cut with mower and as required to maintain specified height. Remove no more than 35 percent of grass leaf growth in initial or subsequent mowings. Do not delay mowing until grass blades bend over and become matted. Do not mow when grass is wet. Time initial and subsequent mowings to maintain grass height of 2½ inches to 3 inches high. Do not mow to less than 2½ inches in height.
- G. Apply second fertilizer application 3 to 4 weeks after seeding emergence and when grass is dry.
 - 1. Use fertilizer that will provide at least 1.0 lb.of actual nitrogen per 1,000 sq.ft. of turf area.

3.7 ACCEPTANCE

- A. When work is complete, including maintenance requirements, notify the Owner. The Owner will then make an inspection to determine acceptability.

- B. Replant rejected work and continue specified maintenance until re-inspected by the Owner and deemed to be acceptable.
- C. Criteria for Acceptance: An acceptable turf is one which is full, even, healthy, uniform stand of specified grass established at least two and one half (2 ½) inches in height. Turf must be free of weeds, stones, surface irregularities, disease, or bare spots greater than 10 x10 square inches.

3.8 CLEANUP AND PROTECTION

- A. During preparation and seeding work, keep pavements clean and work areas in an orderly condition.
- B. Promptly remove soil and debris created by turf work from paved area. Clean wheels of vehicles before leaving site to avoid tracking soil onto surface of roads, walks, or other paved areas.
- C. Protect seeding work and materials from damage due to landscape operations, by other contractors, trades, and trespassers. Maintain protection during installation and maintenance periods. Treat, repair and replace damaged landscape work as directed.
- D. Remove all debris i.e., stones, roots, construction materials, as well as excess soil and legally disposed of off site.

** END OF SECTION **

**SECTION 285010
EXTERIOR PLANTS**

PART 1 - GENERAL

1.1 SUMMARY

- A. This Section includes the following:
 - 1. Topsoil testing.
 - 2. Preparation of planting pits and beds.
 - 3. Furnishing and planting plant material.

- B. Related Sections:
 - 1. Section 280010 “Site Clearing” for protection of existing trees and planting, topsoil stripping and stockpiling, and site clearing.
 - 2. Section 280020 “Earthwork” for preparation of subgrade, subsurface aggregate drainage and drainage backfill and topsoil placement.
 - 3. Section 284010, “Seeded Turf and Grasses”.

1.2 SUBMITTALS

- A. Installer qualifications.

- B. Product certificates of inspection as may be required by governing authorities to accompany shipments. For standard products, submit manufacturer’s certified analysis. For other materials, submit analysis by a recognized laboratory made in accordance with methods established by Association of Official Agricultural Chemists, wherever applicable.

- C. Planting schedule indicating anticipated dates and locations for each type of planting.

- D. Topsoil Analysis Report.

1.3 QUALITY ASSURANCE

- A. General: Comply with applicable federal, state, county, and local regulations governing landscape materials and work.

- B. Installer Qualifications: A qualified landscape Installer whose work has resulted in successful establishment of plants.
 - 1. Professional Membership: Installer shall be a member in good standing of either the Professional Landcare Network or the American Nursery and Landscape Association.
 - 2. Experience: The Installer shall have been actively and directly engaged in planting installations for a period of five (5) years or more, and provide proof of

ten (10) or more successful installations completed by them which have been in use for three (3) or more years.

- C. Substitutions: Do not make unauthorized substitutions of materials. If specified material is not obtainable, submit proposal for use of equivalent material for approval.
- D. Source Quality Control:
 - 1. General: Ship landscape materials with certificates of inspection required by governing authorities. Comply with regulations applicable to landscape materials.
 - 2. Analysis and Standards: Package standard products with manufacturer's certified analysis. For other materials, provide analysis by recognized laboratory made in accordance with methods established by the Association of Official Agriculture Chemists, wherever applicable.
 - 3. Trees, Shrubs and Other Plants: Provide trees, shrubs, and other plants of quantity, size, genus, species, and variety shown and scheduled for landscape work and complying with recommendations and requirements of ANSI Z60.1 "American Standard for Nursery Stock. Provide healthy, vigorous stock, grown in recognized nursery in accordance with good horticultural practice and free of disease, insects, eggs, larvae, mold, mildew, and defects such as knots, sun-scale, injuries, abrasions, or disfigurement. Provide plants grown in USDA Hardiness Zone 5.
 - 4. Label one of each tree and shrub species and variety with securely attached waterproof tag bearing legible designation of botanical and common name.
 - a. Where formal arrangements or consecutive order of trees or shrubs are shown, select stock for uniform height and spread, and label with number to assure symmetry in planting.
 - 5. Provide plant material in compliance with requirements before they are prepared for transplanting.
 - 6. Measurements: Measure trees and shrubs with branches and trunks or canes in their normal position. Do not prune to obtain required sizes. Take caliper measurements 6 inches above ground for trees up to 4 inches caliper size, and 12 inches above ground for trees larger than 4 inches. Measure main body of tree or shrub for height and spread dimensions; do not measure from branch or root tip-to-tip.
 - 7. Inspection: Owner reserves the right to inspect trees and shrubs either at place of growth or at site before planting for compliance with requirements for genus, species, variety, size and quality, size and condition of balls and root systems, insects, injuries, and latent defects and to reject unsatisfactory or defective material at any time during progress of work. Remove rejected trees or shrubs immediately from project site.
- E. Comply with topsoil analysis reports provided for recommended soil amendments and nutrients.
- F. Pre-Installation Conference: Conduct a meeting between the Prime/General Contractor, Sub-Contractors, Owner and the Design Professional to review the scope of work in this section, coordination with other work, special project conditions and quality standards.

- G. Prior to initiating work, conduct whatever investigations necessary, including timely site visits, to ensure that areas are in compliance with requirements and other conditions affecting performance of work under this Section.
1. Refer to Section 280020 Earthwork for such interfacing activities as establishment of grades, preparation of subsoil and provision of topsoil. Verify that subsoil and topsoil condition complies with requirements to the extent that no adverse growing conditions are present. Adverse conditions may include, but are not limited to, presence of construction debris, rock, toxic substances; overly compacted soils; shallow bedrock, improper grades, and/or inadequate depth of topsoil.
 2. Refer to Section 286010 Storm Utility Drainage Piping for implementation of stormwater controls. Verify that conditions comply with requirements to the extent that no adverse growing conditions are present. Adverse conditions may include, but are not limited to, improperly graded swales or channels, clogged inlets or subdrains or other factors contributing to standing water or poorly drained soils.
 3. Do not proceed with work until deficiencies are corrected. By proceeding, the installer is agreeing that conditions are acceptable for performance of the work covered under this Section.

1.4 DELIVERY, STORAGE, AND HANDLING

- A. Delivery of Trees and Shrubs: Provide freshly dug trees and shrubs to the greatest extent possible. Do not prune before delivery. Provide adequate protection of root systems and balls from drying winds and sun. Do not bend or bind-tie trees or shrubs in such a manner as to damage bark, break branches, or destroy natural shape. Provide protective covering during delivery. Do not drop balled and burlapped stock during delivery.
- B. Deliver trees and shrubs after preparations for planting have been completed and plant immediately. If planting is delayed more than 6 hours after delivery, set trees and shrubs in shade, protect from weather and mechanical damage, and keep roots moist as follows:
1. Set balled stock on ground and cover ball with soil, peat moss, sawdust or other acceptable material.
 2. Do not remove container-grown stock from containers before time of planting.
 3. Periodically water root systems of trees and shrubs stored on site with a fine mist spray. Water as often as necessary to maintain root systems in a moist condition.

1.5 JOB CONDITIONS

- A. Planting Time: Proceed with, and complete landscape work as soon as portions of the site become available, working within seasonal limitations for each kind of landscape work required.

1. Plant or install materials during normal planting seasons for each type of plant material required. Correlate planting with specified maintenance periods to provide maintenance from date of substantial completion.
- B. Coordination with Turf: Plant trees and shrubs after final grades are established and before planting of turf. If planting of trees and shrubs occurs after turf work, protect turf areas and promptly repair damage to turf resulting from planting operations.
- C. Utilities: Determine location of underground utilities and perform work in a manner which will avoid possible damage. Hand excavate, as required. Maintain grade stakes set by others until removal is mutually agreed upon by parties concerned.
- D. Excavation: When conditions detrimental to plant growth are encountered, such as rubble fill, adverse drainage conditions, or obstructions, notify Owner before planting for instructions to proceed.

1.6 WARRANTY

- A. Warrant trees and shrubs, for a period of one year after date of substantial completion, against defects including death and unsatisfactory growth, but excepting defects resulting from neglect by Owner, abuse or damage by others, or unusual phenomena or incidents beyond Installer's control.
- B. Remove and replace trees, shrubs, or other plants found to be dead or in unhealthy condition during warranty period. Make replacements during growth season following end of warranty period. Replace trees and shrubs which are more than 25% dead at end of warranty period; unless, it is advisable to extend warranty period for a full growing season.
 1. Another warranty inspection will be conducted at end of extended warranty period, if any, to determine acceptance or rejection. Only one replacement (per tree, shrub or plant) will be required at end of warranty period, except for losses or replacements due to failure to comply with specified requirements.

PART 2 - PRODUCTS

2.1 TREE AND SHRUB MATERIAL

- A. General: Provide nursery grown trees and shrubs, except as otherwise indicated, grown in a recognized nursery in accordance with good horticultural practice, with healthy root systems developed by transplanting or root pruning. Provide only healthy, vigorous stock free of disease, insects, eggs, larvae, mildew, mold and defects such as knots, sun scale, injuries, abrasions, and disfigurement.
- B. Size: Provide trees and shrubs of the sizes indicated in planting list and in accordance with dimensional relationship requirements of ANSI Z60.1 for kind and type of trees and shrubs required. Trees and shrubs of larger size than specified may be used in that case, increase size of roots or balls proportionately.

C. Label at least one tree and one shrub of each variety with a securely attached waterproof tag bearing legible designation of botanical and common name.

1. Where formal arrangements or consecutive order of trees or shrubs are shown, select stock for uniform height and spread, and label with number to assure symmetry in planting.

2.2 DECIDUOUS TREES

A. Size: Provide trees of height and caliper indicated.

1. Take caliper measurements 6 inches above ground level if 4 inches or less. If greater than 4 inches, take measurement at 12 inches above ground level.

B. Where shade trees are required, provide single-stem trees with straight trunk and intact leader, free of branches to a point about 50 percent of their height, as recommended by ANSI Z60.1 for size and kind of trees required.

C. Where small trees of upright or spreading type are required, provide trees with single stem, branched or pruned naturally according to species and type, and with relationship of caliper and branching recommended by ANSI Z60.1, unless otherwise indicated.

1. Where shown as “brush form”, provide trees with branching starting close to ground in manner of a shrub.
2. Where shown as “clump”, provide trees with 3 or more main stems starting from ground.

D. Except as otherwise indicated, provide balled and burlapped trees.

1. Container-grown deciduous trees will be acceptable in lieu of balled and burlapped deciduous trees, subject to the specified limitations for container stock.

2.3 DECIDUOUS SHRUBS

A. Size: Dimensions shown or listed indicate required size. (as it commonly pertains to plant character)

B. Form: Provide deciduous shrubs with not less than minimum number of canes required by ANSI Z60.1 for type and height of shrub required.

C. Provide balled and burlapped deciduous shrubs.

1. Container-grown deciduous shrubs will be acceptable in lieu of balled and burlapped deciduous shrubs subject to specified limitations for container-grown stock.

2.4 CONIFEROUS AND BROADLEAF EVERGREENS

- A. Size: Provide evergreens of the sizes shown. Dimensions indicate minimum spread for spreading and semi-spreading evergreens and height for other types, such as globe, dwarf, cone, pyramidal, broad upright, and columnar. Provide evergreens with well-balanced form that comply with requirements for other size relationships to the primary dimension indicated.
- B. Form: Provide normal quality evergreens unless indicated as “specimen”.
- C. Provide balled and burlapped evergreens.
 - 1. Container-grown evergreens will be acceptable subject to specified limitations for container grown stock.

2.5 REQUIREMENTS FOR B&B STOCK

- A. General: Where indicated to be balled and burlapped, provide trees and shrubs dug with firm, natural ball of earth in which they are grown.
- B. Provide ball size of not less than diameter and depth recommended by ANSI Z60.1 for type and size of tree or shrub required. Increase ball size or modify ratio of depth to diameter as required to encompass fibrous and feeding root system necessary for full recovery of trees and shrubs subject to unusual or non-typical conditions of growth, soil conditions, or horticultural practice.
- C. Wrap and tie earth ball as recommended by ANSI Z60.1 for size of balls required. Drum-lace balls with a diameter of 30 inches or greater.

2.6 REQUIREMENTS FOR CONTAINER GROWN-STOCK

- A. General: Where specified as acceptable, provide healthy, vigorous, well-rooted trees or shrubs established in container in which they are sold. Provide balled and burlapped stock when required trees or shrubs exceed maximum size recommended by ANSI Z60.1 for container-grown stock.
- B. Established container stock is defined as a tree or shrub transplanted into container and grown in container for a length of time sufficient to develop new fibrous roots, so that root mass will retain its shape and hold together when removed from container.
- C. Containers: Use rigid containers that will hold ball shape and protect root mass during shipping. Provide trees and shrubs established in containers of not less than minimum sizes recommended by ANSI Z60.1 for kind, type, and size of trees and shrubs required.

2.7 GROUND COVER

- A. Provide plants established and well rooted in removable containers or integral peat pots and with not less than minimum number and length of runners required by ANSI Z60.1 for the pot size shown or listed. Provide plants free of disease, mildew, mold and insects.
- B. Provide full-bodied plants in No. SP3 (1 Pt.) containers, one (1) year plants.

- C. Provide full-bodied plants in No. SP4 (1 Qt.) containers, two (2) year plants.

2.8 PERENNIALS AND ORNAMENTAL GRASSES

- A. Provide healthy, vigorous, well rooted container grown or field potted plants of sizes indicated in accordance with ANSI Z60.1 Provide plants free of disease, mildew, mold and insects.

2.9 TOPSOIL

- A. Stripping, storage, bulk placement of topsoil and imported topsoil is provided for in Sections 280010 and 280020. If depth of topsoil is not as specified notify Owner for directions prior to proceeding.
- B. Topsoil may be stockpiled for re-use in landscape work. If quantity or quality of stockpiled topsoil is insufficient, provide additional topsoil as required to complete landscape work at no additional cost to owner.

2.10 SOIL AMENDMENTS

- A. General: Fertilizers and soil amendments application shall be based upon topsoil analysis report.
- B. Aluminum Sulfate: Commercial-grade.
- C. Bonemeal: Commercial-grade, raw, finely ground; 4 percent nitrogen and 20 percent phosphoric acid.
- D. Fertilizers: Commercial-grade controlled release fertilizer, of neutral character, with some elements derived from organic sources, containing at least 10 percent available phosphoric acid, 3 percent to 5 percent total nitrogen, and 3 percent to 5 percent soluble potash.
- E. Agricultural Gypsum: Pelletized gypsum (90% percent calcium sulfate).
- F. Green Sand: Glauconite.
- G. Lime: Pulverized Dolomitic limestone containing not less than 85 percent of total carbonates with a minimum of 30 percent magnesium carbonates. Lime shall be ground so that not less than 90 percent passes a 10-mesh sieve.
- H. Peat Moss: Composed of mosses (other than sphagnum) or reed-sedge peat of a coarse fibrous texture and with pH of 6.0 to 7.5.
 - 1. For acid-loving trees and shrubs, provide peat moss with pH of 3.2 to 4.5, coarse, fibrous texture, medium-divided sphagnum moss peat or reed-sedge moss peat.
- I. Organic Matter:
 - a. Manure

- b. Well-rotted compost comprised primarily of vegetable matter.
- c. Well-rotted leafmold.
- J. Perlite: Conforming to National Bureau of Standard PS 23.
- K. Sand: Clean, washed sand, free of toxic materials.
- L. Superphosphate: Soluble mixture of treated minerals; 20 percent available phosphoric acid.
- M. Vermiculite: Horticultural grade, free of toxic substances.

2.11 PERENNIAL BED SOIL MIX

- A. Soil mix components:
 1. Topsoil.
 2. Organic matter.
 3. Ground limestone.
 4. Complete fertilizer, 5-10-5

2.12 TREE AND SHRUB PLANTING PIT SOIL MIX

- A. Soil mix components:
 1. Satisfactory excavated native soil (topsoil and subsoil).
 2. Organic matter or peat moss.

2.13 MISCELLANEOUS MATERIALS

- A. Anti-Dessicant: Emulsion type, film-forming agent designed to permit transpiration, but retard excessive loss, of moisture from plants.
- B. Bark Mulch: Double-shredded and cured hardwood bark of varying particle sizes uniformly blended, free of large chunks, pieces or slabs. Mulch containing chipped lumber products is not acceptable. Color to be natural (free of dyes).
- C. Herbicides: EPA registered and approved.
 1. Pre-emergent herbicide: Treflan EC or approved equal (active ingredient: trifluralin).
 2. Non-selective herbicide: Roundup or approved equal (active ingredient: glyphosate).
- D. Stakes and Guys: Provide stakes of sound hardwood, free of knot holes and other defects. Provide wire ties and guys of 12 gage, 2-strand, twisted, pliable galvanized steel wire. Provide rubber hose at least ½ inch diameter, cut to required lengths to protect tree trunks from damage by wires.

- E. Separation Fabric: Non-woven polypropylene fabric. Product No. 1120N as manufactured by Nicolon MIRAFI Group or approved equal.
- F. Stakes and Guys: Provide stakes of sound hardwood, free of knot holes and other defects. Provide wire ties and guys of 12 gauge, 2-strand, twisted, pliable galvanized steel wire. Provide rubber hose at least ½ inch diameter, cut to required lengths to protect tree trunks from damage by wires.

PART 3 - EXECUTION

3.1 PREPARATION FOR PLANT MATERIAL - GENERAL

- A. Cooperate with other contractors and trades working in and adjacent to landscape work areas. Examine drawings that show development of entire site and become familiar with scope of other work required.
- B. Stake out individual tree and shrub locations for approval. Spray paint planting bed outlines for approval. Make adjustments as directed by Owner. Do not begin plant installation until the layout has been approved by the Owner.
- C. Excavation: Excavate planting pits and beds to the dimensions shown. Dispose of unsatisfactory subsoil or construction debris removed from landscape excavations. Do not mix with planting soil or use as backfill.
- D. Obstructions: If rock, underground construction or other obstructions are encountered in excavation for planting of trees or shrubs, notify Owner immediately.
- E. Hardpan Layer: If hardpan layer is encountered, drill 6-inch diameter holes into free-draining strata or to a depth of 10 feet, whichever is less, and backfill with ½ inch stone (AASHTO No. 8).
- F. Drainage: Fill excavations with water and allow to percolate out before setting trees and shrubs. If subsoil conditions indicate retention of water in planting areas, notify Owner immediately.
- G. Thoroughly and uniformly roto-till all topsoil. Before mixing, clean topsoil of roots, plants, sod, stones, clay lumps, and other extraneous materials harmful to plant growth.
- H. Treat all planting beds with pre-emergent herbicide prior to planting.
- I. Mix fertilizers with topsoil at rates specified by the topsoil analysis report. Delay mixing of fertilizer if planting will not follow placing of planting soil within a few days.
- J. For planting pit backfill, prepare soil mixes before backfilling.

3.2 PREPARATION OF PERENNIAL PLANT BEDS

- A. Soil Preparation: Place soil mix to a uniform depth of twelve inches (12”) upon scarified subgrade.

- B. Combine one part organic matter to four parts topsoil.
- C. Spread lime over surface at rate required by topsoil analysis report for specified pH of soil and thoroughly till into full depth of prepared mix. Final pH shall range from 5.5 to 7.5.
- D. Apply fertilizer to prepared bed at rate required by topsoil analysis report results and thoroughly incorporate into soil.

3.3 INSTALLATION OF PLANT MATERIAL

- A. Setting and Backfilling:
 1. Set balled and burlapped stock plumb and in center of pit or trench. Remove all twine and top one third of burlap from root ball. Remove pallets, if any, and wire baskets completely before setting. Replace plant material if ball is cracked or broken before or during planting operation.
 2. Set container-grown stock as specified for balled and burlapped stock, except that containers shall be cut away from the root ball completely. Carefully remove containers so that root ball is not damaged. Lightly tease away roots which are girdling around the edge of the root ball.
 3. When root ball is set, place additional backfill around base and sides of ball, and work each layer to settle backfill and eliminate air pockets. When excavation is approximately 2/3 full, water thoroughly before placing remainder of backfill. Repeat watering until no more is absorbed. Water again after placing final layer of backfill. Do not place backfill against trunk or cover the root crown.
 4. Trees and shrubs in native backfill: Backfill with four parts satisfactory native soil to one part organic matter.
 5. When backfilling is complete, form saucer as indicated.
- B. Apply anti-dessicant to provide an adequate film over trunks, branches, stems twigs, and foliage.
 1. If deciduous trees or shrubs are moved in full-leaf, spray with anti-dessicant at nursery before moving and again two weeks after planting.
- C. Prune, thin out, and shape trees and shrubs in accordance with standard horticultural practice. Prune trees to retain required height and spread. Do not cut tree leaders, and remove only injured or dead branches from trees. Prune shrubs to retain natural character. Required shrub sizes indicated are size after pruning.
- D. Guy and stake trees immediately after planting.
 1. Stake trees of two inch through five inch caliper as shown on the drawings. Stake trees of less than two inch caliper only as required to prevent wind tip-out. Set stakes vertical and space to avoid penetrating balls or root masses. Support trees with wire encased in hose sections at contact points with tree trunk. Allow enough slack to avoid rigid restraint of tree. Provide not less than one stake for trees 10 ft. to 12 ft. high and two inches or less in caliper, except no fewer than

two shorter stakes may be used for low-branched trees. Use no fewer than 2 stakes for trees over 12 ft. high and less than four inch caliper size and use no fewer than three stakes for trees of four inch to five inch caliper size. Space stakes equally around trees.

3.4 PLANTING GROUNDCOVER, PERENNIAL PLANTS AND ORNAMENTAL GRASSES

- A. Space plants as directed by Owner.
- B. Dig holes large enough to allow spreading of roots, and backfill with planting soil. Work soil around roots to eliminate air pockets, taking care not to cover plant crowns with soil. Water thoroughly after planting.

3.5 MULCHING

- A. Mulch backfilled surfaces of planting pits, planting beds.
 - 1. Thickness: 3 inches.
- B. Do not place mulch against trunk or cover the root crown of trees and shrubs.
- C. Where mulch edge abuts turf, provide crisp, well-defined edge between mulch and turf.

3.6 MAINTENANCE

- A. Begin maintenance immediately after planting.
- B. Maintain trees, shrubs, and other plants until final acceptance, but in no case, less than the following period:
 - 1. 60 days after substantial completion of planting.
- C. General: Prune, water, cultivate, and weed during maintenance period as required for healthy growth. Restore planting saucers. Tighten and repair stake and guy supports, but not to the point of rigidity, and reset trees and shrubs to proper grades or vertical position as required. Restore or replace damaged wrappings. Spray as required to keep trees and shrubs free of insects and disease using organic insect and disease control products.
- D. Remove and replace trees and shrubs found to be dead or unhealthy during warranty period. Make replacements during growth season following end of warranty period. Replace trees and shrubs that are in doubtful condition at end of warranty period unless it is advisable to extend warranty period for a full growing season.
- E. Removal of stakes and guy wires will be the responsibility of the landscape contractor upon final acceptance of the plant material after warranty period.

3.7 CLEANUP AND PROTECTION

- A. During landscape work, keep pavements clean and work area in an orderly condition.
- B. Protect landscape work and materials from damage due to landscape operations, operations by other contractor and trades, and trespassers. Maintain protection during installation and maintenance periods. Treat, repair, or replace damaged landscape work as directed.

3.8 DISPOSAL OF SURPLUS SOIL AND WASTE MATERIALS

- A. Disposal: Remove surplus soil and waste material, including excess subsoil, trash and debris, and legally dispose of it off the Owner's property.

3.9 INSPECTION AND ACCEPTANCE

- A. When landscape work is complete, including maintenance, notify Owner who will, make an inspection to determine acceptability.
- B. When inspected landscape work does not comply with requirements, replace rejected work and continue specified maintenance until re-inspected by Owner and found to be acceptable. Remove rejected plants and materials promptly from project site.

** END OF SECTION **

SECTION 286010
STORM UTILITY DRAINAGE PIPING

PART 1 - GENERAL

1.1 SUMMARY

- A. This Section includes the following:
 - 1. Site storm water system piping and appurtenant drainage structures from a point 5 feet outside any building to the point of disposal.
- B. Related Sections:
 - 1. Section 280010 “Site Clearing and Construction Layout” for storm drainage system layout and coordination.
 - 2. Section 280030 “Erosion and Sedimentation Control for ESC requirements and regulatory compliance.
 - 3. Section 280020 “Earthwork” for Trench excavation and backfill required for installation of the storm drainage system piping and appurtenant drainage structures.
 - 4. Section 12 “Plumbing” for storm sewer systems within buildings.

1.2 SUBMITTALS

- A. Product data for drainage piping and piping specialties.
- B. Shop drawings for storm drainage structures; including frames, covers, and grates.
- C. Test Pit Data: Provide drawings indicating relationships of utilities discovered including top and bottom elevations, horizontal locations of pipes, conduits, etc., and elevations / locations of all adjacent utility lines within area specified to be located or confirmed by a test pit.
- D. Record drawings at project closeout of installed storm sewer system piping and products. Provide all information required by municipality or authority in jurisdiction. Information to include (but is not limited to) the following:
 - 1. Plans indicating all final locations of storm sewer lines, structures, inverts, sizes, length and slopes of all pipes, etc.
 - 2. Provide dimensions from faces of curb, buildings and other adjacent utilities.
 - 3. Provide depths of lines and indicate at a maximum 50-foot interval.
 - 4. Provide digital as-built drawings and provide to authority having jurisdiction where required.
 - 5. Provide signature and seal of registered surveyor responsible for the as-built drawings. Provide benchmark and datum consistent with project documents.

1.3 QUALITY ASSURANCE

- A. Environmental Compliance: Comply with applicable portions of federal, state and local environmental agency regulations pertaining to storm drainage systems.
- B. Municipal Compliance: Comply with local municipal regulations and standards pertaining to storm drainage systems.
- C. Structural Design Loading: Unless otherwise noted, utilities, structures and underground conveyance systems shall be constructed to withstand traffic loading designation A-16 (HS-20) per ASTM C 890-91.
- D. Pre-Installation Conference: Conduct a meeting between the Prime/General Contractor, Sub-Contractors, Owner, Testing Agency and the Design Professional to review the scope of work in this section, coordination with other work, special project conditions and quality standards. Notify all parties and schedule the meeting a minimum of two (2) weeks prior to the anticipated start of the work specified under this Section.

1.4 PROJECT CONDITIONS

- A. Site Information: Prior to beginning the installation of the storm drainage system, the contractor shall: Investigate existing underground utility locations, research public and site utility records, and dig test pits in areas specified on the construction drawings to verify existing utility depths and locations and to verify that storm drainage system piping may be installed in compliance with original design and referenced standards. If the contractor determines that the original design is in conflict with the existing utilities, he shall immediately notify the Owner of such conflict.
 - 1. Locate existing storm drainage system piping and structures that are to be abandoned and closed.
- B. Existing Utilities: Do not interrupt utilities serving facilities occupied by Owner or others unless permitted under the following conditions and then only after arranging to provide temporary utility services according to requirements indicated. Follow the requirements of the governing authority where applicable.
 - 1. Notify Owner not less than two days in advance of proposed utility interruptions.
 - 2. Notify the governing authority per authority's advanced notice requirements. Do not proceed with utility interruptions without Owner's /and governing utility authority's written permission.

1.5 SEQUENCING AND SCHEDULING

- A. Coordinate connection to public drainage system with the municipality or agency having jurisdiction.
- B. Coordinate connection of interior building storm drainage piping with the plumbing contractor.

- C. Coordinate with other utility work.

1.6 DELIVERY, STORAGE AND HANDLING

- A. Do not store plastic structures, pipe, and fittings in direct sunlight.
- B. Protect pipe, pipe fittings and seals from dirt and drainage.
- C. Handle precast concrete structures according to manufacturer's rigging instructions.

PART 2 - PRODUCTS

2.1 PIPE AND FITTINGS

- A. General: Provide pipe and pipe fitting materials compatible with each other and of the type of pipe and size specifically called out and indicated on the drawings. Where more than one type of materials or products is indicated or noted for specific locations on the drawings, selection is Installer's option. Pipe and joint materials for the type of pipe indicated on the drawings shall, unless otherwise indicated, conform to the material requirements herein specified.
- C. PVC (Polyvinyl Chloride) Gravity Sewer Pipe and Fittings (4-inch through 15-inch diameters): Type PSM SDR-35, ASTM D 3034, for solvent cement or elastomeric gasket joints; ASTM D 3212.
 - 1. Solvent Cement: Solvent cement per ASTM D 2564.
 - 2. Elastomeric gasket joints: Gaskets per ASTM F 477.
- G. Smooth-Lined Corrugated High Density Polyethylene (SLHDPE) Solid and Slotted Pipe and Fittings, Gravity Flow Storm Drainage Application 12-inch diameter and larger:
 - 1. References:
 - a AASHTO M 294-98: Standard Specification for Corrugated Polyethylene Pipe, 12" to 48" Diameter.
 - b AASHTO MP7-97 Standard Specification for Corrugated Polyethylene Pipe, 60".
 - c ASTM D2321-89: Standard Practice for Underground Installation of Thermoplastic Pipe for Sewers and Other Gravity-Flow Applications.
 - d ASTM D3350: Standard Specification for Polyethylene Plastic Pipe and Fittings Materials.
 - e ASTM F477-93: Specifications for Elastomeric Seals (Gaskets) for Joining Plastic Pipe.
 - 2. Material Properties:
 - a Pipe and fitting materials shall be made from virgin high-density polyethylene compounds which conform with the requirements of

ASTM D3350 resin cell classification 335420C or ASTM 01248 Type III, Class C, Category 4, Grade P33.

3. Joints and Fittings:
 - a Joint Requirements: Joints shall consist of a bell and spigot type joint with an o-ring rubber gasket meeting ASTM F477 placed on the spigot end. The bell end shall engage a minimum of two (2) corrugations to provide sufficient longitudinal strength, preserve pipe alignment, and prevent separation at the joints.
 - b Fittings Requirements: Pipe fittings shall be manufactured to conform to AASHTO M294. They shall not reduce or impair the overall integrity of function of the pipe line. Only fittings supplied or recommended by the pipe manufacturer shall be used.
4. Slotted pipe shall be factory wrapped with geotextile filter fabric.

2.2 MANHOLES

- A. Precast Concrete Manholes: ASTM C 478 or ASTM 913 and AASHTO M 199, precast reinforced concrete, of depth indicated with provision for rubber gasket joints. Top section and grade rings shall match the frame and cover specified.
 1. Base Section: 6-inch minimum thickness for floor slab and 5 inch minimum thickness for walls and base riser section, and having a separate base slab or base section with integral floor.
 2. Riser Sections: 5 inch minimum thickness, 48 inch diameter, and lengths required to provide depth indicated.
 3. Top Section: Eccentric cone type, unless concentric cone or flat-slab-top type is indicated. Top of cone to match grade rings.
 4. Grade Rings: Provide reinforced concrete rings as necessary to match 24 inch diameter frame and cover.
 5. Pipe Connection Types: ASTM C 270-91a, "Standard Specification for Mortar for Unit Masonry" requirements. Mortar joints shall be smooth and flush with manhole walls.
 6. Channel and Bench: Concrete.
- B. Manhole Steps: Copolymer polypropylene "press fit" by M.A. Industries, Inc. conforming with ASTM C 478, installed into the sidewall of base, riser and top sections, or approved equal. Wide enough for an adult to place both feet on one step and designed to prevent feet from slipping forward, backward or sideward off the step. Steps shall be provided in all structures of three (3) feet or more in depth between top of cover or grate and invert elevation.
 1. Material: Plastic manhole steps shall be in conformance with ASTM C 478 and shall be of copolymer polypropylene conforming to ASTM D 4101-92B (PP200B33454202) compound, shall encase a ½ inch Grade 60 Steel reinforcing rod conforming to ASTM A 615.
 2. Manhole Steps: Shall be inserted as per manufacturer's recommendations into manhole walls and elsewhere as indicated, and shall be aligned to form a continuous ladder with rungs equally spaced vertically at a maximum distance of

12 inches apart. The top step should be a maximum of 16 inches below the manhole cover. Steps shall be embedded in the manhole wall a minimum distance of 3 inches and rungs or cleats shall project a minimum clear distance of 5 inches from the interior manhole wall, measured from the point of embedment.

- C. Manhole Frames and Covers: ASTM A 536, Grade 60-40-18, heavy-duty ductile iron, or ASTM A 48-83 class 35 cast iron, 24 inch inside diameter by 5 to 8 inch riser with 4 inch minimum width flange, and 26 inch diameter cover, indented top design, with lettering "STORM DRAIN" cast into cover.

2.3 CLEANOUTS

- A. PVC Cleanouts: PVC female fitting with PVC threaded brass plug. Include PVC sewer pipe fitting and riser to cleanout of same material as sewer piping. Provide risers and fittings as necessary to meet differential inverts at the cleanout.
- B. Heavy duty cover: For cleanouts in paved areas exposed to automobile traffic, round cast-iron access frame and heavy-duty, secured, scoriated cast-iron cover.
- C. Concrete Encasement for Riser: For cleanouts in paved areas exposed to automobile traffic, provide 3000 P.S.I. minimum concrete encasement around riser as shown on drawings.

2.4 INLETS

- A. Precast Concrete Inlets: ASTM C 478 or ASTM C 913, precast reinforced concrete, of depth indicated, with provision for rubber gasket joints. The top section and grade rings shall match the frame and grate for the inlet type specified.
 - 1. Base Section: 6-inch minimum thickness for floor slab and 6-inch minimum thickness of walls and base riser section for rectangular structures and 5-inch minimum thickness of walls and base riser section for 48 inch circular structures and having a separate base slab or a base section with integral floor.
 - 2. Riser Sections: 6-inch minimum thickness for rectangular structures and 5-inch minimum thickness for 48 inch circular structures and lengths required to provide the depth indicated.
 - 3. Top Section: Flat slab type with opening to match grade rings and frame and grate.
 - 4. Eccentric cone type where indicated for circular lawn inlets, with top of cone to match grade rings.
 - 5. Grade Rings: Provide reinforced concrete rings, as necessary to match dimensions of frame and grate.
 - 6. Gaskets: ASTM C 443, rubber.
 - 7. Pipe Connectors: ASTM C 270-91a, "Standard Specification for Mortar for Unit Masonry" requirements. Mortar joints shall be smooth and flush with manhole walls.
 - 8. Channel and Bench: Concrete.
 - 9. Corner intersections of pipes and structures are prohibited.

- B. Inlet Steps: Wide enough for an adult to place both feet on one step and designed to prevent feet from slipping forward, backward or sideward off the step. Steps shall be provided in all structures of three (3) feet or more in depth between top of grate and invert elevation.
 - 1. Material: Plastic manhole steps shall be in conformance with ASTM C 478 and shall be of copolymer polypropylene conforming to ASTM D 4101 (PP200B33454202) propylene copolymers. The copolymer polypropylene compound shall encase a ½ inch Grade 60 Steel reinforcing rod conforming to ASTM A 615.
 - 2. Inlet Steps: Shall be inserted as per manufacturer's recommendations into inlet walls and elsewhere as indicated, and shall be aligned to form a continuous ladder with rungs equally spaced vertically at a maximum distance of 12 inches apart. The top step should be a maximum of 16 inches below the manhole cover. Steps shall be embedded in the manhole wall a minimum distance of 3 inches and rungs or cleats shall project a minimum clear distance of 5 inches from the interior manhole wall, measured from the point of embedment.
- D. Rectangular Inlet Frames and Grates: ASTM A 536 Grade 60-40-10, heavy-duty ductile iron PENNDOT Type M frames with 3 ¼ inch riser, 4 inch minimum width flange and PENNDOT Structural Steel Bicycle Safe Grates, all conforming to PENNDOT Publication 72, RC-34 and PENNDOT Publication 408, Section 1105.03.
- E. Drain Basins: Advanced Drainage Systems, Inc. (ADS), 3300 Riverside Drive, Columbus, OH 43221, Tel: 800-821-6710.

2.5 CONCRETE AND REINFORCEMENT

- A. Concrete: Portland cement mix, 4,000 psi, 5.5% Air Entrained.
 - 1. Cement: ASTM C 150, Type II.
 - 2. Fine Aggregate: ASTM C 33, sand.
 - 3. Coarse Aggregate: ASTM C 33, crushed gravel.
 - 4. Water: Potable.
- B. Reinforcement: Steel conforming to the following:
 - 1. Fabric: ASTM A 185, welded wire fabric, plain.
 - 2. Reinforcement Bars: ASTM A 615, Grade 60, deformed.

2.6 TRENCH DRAIN

- A. Precast polymer concrete trench drain system, PolyDrain, as manufactured by ABT, Inc., PO Box 837 / 259 Murdoct Road, Troutman, NC 28166 Tel 800-438-6057. System to include the following:
 - 1. Drain Trench: 6.1"W, 4" I.D. with radiused bottom, sloped at 0.6%, per 39.19" length.
 - 2. Beginning minimum depth 12.2 inches.
 - 3. Provide continuous slope on each run.
 - 4. Slotted Grate in-lay type, No.502 ductile iron, with locking slots and toggles.

5. Provide PolyDrain catch basin / junction box with side panel minimum depth of 30" and minimum width of 24".

PART 3 - EXECUTION

3.1 EARTHWORK

- A. Excavation, trenching, backfilling and abandonment of pipes shall be as specified in Section 280020, "Earthwork", and Section 280040 "Excavation Support and Protection".

3.2 PIPE APPLICATIONS FOR UNDERGROUND STORM DRAINAGE SYSTEMS

- A. PVC Solvent Cement or Elastomeric Gasket Joint Pipe and Fittings: Pipe sizes 4-inch through 15-inch diameters.
- B. PVC Elastomeric Gasket Joint Pipe and Fittings: 18-inch through 27-inch diameters.
- C. Corrugated Polyethylene Pipe and Fittings: Pipe sizes 6-inch diameter and larger.

3.3 INSTALLATION, GENERAL

- A. General: Install the piping as indicated, to the extent practical. Any proposed variation of locations, invert or pipe slope requires prior approval of the Owner.
- B. Install piping beginning at low point of systems, true to grades and alignment indicated with unbroken continuity of invert. Place bell ends of piping facing upstream. Install gaskets, seals, sleeves, and couplings in accordance with manufacturer's recommendations for use of lubricants, cements, and other installation requirements. Maintain swab or drag in line and pull past each joint as it is completed.
- C. Use manholes or inlets for changes in direction. Use fittings for branch connections, except where direct tap into existing pipe is specifically indicated.
- D. Use proper size increasers, reducers, and couplings, where different size or material of pipes and fittings are to be connected. Reduction of the size of piping in the direction of flow is prohibited.
- E. Install piping pitched down in direction of flow, at minimum slope of 2 percent.
- F. Extend storm drainage system piping to connect to building storm drains, of sizes and in locations indicated.
- G. Pipe trench backfilling shall comply with requirements of Earthwork Section 280020.
- H. Tunneling: Install pipe under streets or other obstructions that cannot be disturbed, by tunneling, jacking, or a combination of both, subject to the approval of and in accordance with the requirements of the municipality or agency having jurisdiction.

- I. Provide casing pipe for protection of internal carrier pipe when pass through walls, foundations, etc. Fill the space between the casing and carrier pipes with grout 90 percent full. Seal ends of casing pipe with brick and mortar block.

3.4 PIPE JOINT CONSTRUCTION AND INSTALLATION

- A. PVC (Polyvinyl Chloride) Gravity Sewer Pipe and Fittings (4-inch through 15-inch diameters): Type PSM SDR-35, ASTM D 3034, for solvent cement or elastomeric gasket joints; ASTM D 3212.
 1. Solvent Cement Joints: Assembly per ASTM D 2855.
 2. Elastomeric Gasket Joints: Assembly per ASTM D 3212.
- B. Join and install Corrugated Polyethylene Pipe as follows:
 1. Pipe and gasketed coupling in accordance with ASTM F 667 and AASHTO M 294.
 2. Installation shall be in accordance with ASTM D 2321.

3.5 MANHOLES

- A. General: Install manholes complete with accessories as indicated on the drawings. Form continuous concrete or split pipe section channel and benches at the level indicated between inlets and outlet of the manhole. Set tops of frames and covers flush with finish surface where manholes occur in pavements. Elsewhere, set tops flush with finish surface.
- B. Place precast concrete manhole sections as indicated, and install in accordance with ASTM C 891.
- C. Provide rubber joint gasket complying with ASTM C 443 at joints of sections.

3.6 CLEANOUTS

- A. Install cleanouts and extension from drain pipe to cleanout at grade as indicated on the plans. Set cleanout frame and cover in concrete block 18 by 18 by 12 inches deep, except where location is in concrete paving. Set top of cleanout 1 inch above surrounding earth grade or flush with grade when installed in paving. Encase in concrete where indicated.

3.7 INLETS

- A. Install inlets of sizes and shapes indicated with accessories as indicated.
- B. Set frames and grates to elevations indicated.
- C. Provide protection for Inlets from heavy equipment and traffic during construction period.

3.8 TRENCH DRAIN

- A. Install trench drain to top elevation indicated. Encase bottom and sides in concrete.

3.9 FIELD QUALITY CONTROL

- A. Cleaning: Clear interior of piping and structures of dirt and other superfluous material as work progresses. Maintain swab or drag in piping and pull past each joint as it is completed.
 - 1. Place plugs in ends of uncompleted pipe at end of day or wherever work stops.
 - 2. Flush piping between manholes to remove collected debris.

- B. Interior Inspection: Inspect piping to determine whether line displacement or other damage has occurred.
 - 1. Make inspections after pipe between manholes and manhole locations has been installed and approximately 2 feet of backfill is in place, and again at completion of project.
 - 2. If inspection indicates poor alignment, debris, displaced pipe, sagging, deflection, infiltration, or other defects, correct such defects to the satisfaction of the Design Professional and re-inspect.
 - 3. Perform soil compaction testing at minimum 100 ft. intervals after approximately 2 feet of initial backfill in place over the top of the pipe and on every lift thereafter up to the subgrade elevation. Where the compaction fails to meet the level required under Section 280020 Earthwork, the backfill material shall be removed and replaced in properly compacted lifts until the specified degree of compaction is reached for the full backfill depth.

** END OF SECTION **

SECTION 286020 SUBDRAINAGE

PART 1 - GENERAL

1.1 SUMMARY

- A. Section Includes:
1. Perforated-wall pipe and fittings.
 2. Drainage panels.
 3. Geotextile filter fabrics.

1.2 ACTION SUBMITTALS

- A. Product Data:
1. Drainage panels, including rated capacities.
 2. Geotextile filter fabrics.

PART 2 - PRODUCTS

2.1 PERFORATED-WALL PIPES AND FITTINGS

- A. Perforated PE Pipe and Fittings:
1. **NPS 6 (DN 150)** and Smaller: ASTM F 405 or AASHTO M 252, Type CP; corrugated, for coupled joints.
 2. Couplings: Manufacturer's standard, band type.
- B. Perforated PVC Sewer Pipe and Fittings: ASTM D 2729, bell-and-spigot ends, for loose joints.

2.2 DRAINAGE PANELS

- A. Molded-Sheet Drainage Panels: Prefabricated geocomposite, **36 to 60 inches** wide with drainage core faced with geotextile filter fabric.
1. Drainage Core: Three-dimensional, nonbiodegradable, molded PP.
 - a. Minimum Compressive Strength: **21,000 lbf/sq. ft.** when tested according to ASTM D 1621.
 - b. Minimum In-Plane Flow Rate: **7 gpm/ft.** of unit width at hydraulic gradient of 1.0 and compressive stress of **25 psig** when tested according to ASTM D 4716.

2. Filter Fabric: Woven geotextile fabric, manufactured for subsurface drainage, made from polyolefins or polyesters; with elongation less than 50 percent; complying with the following properties determined according to AASHTO M 288:
 - a. Survivability: Class 2.
 - b. Apparent Opening Size: **No. 60** sieve, maximum.
 - c. Permittivity: 0.2 per second, minimum.
3. Film Backing: Polymeric film bonded to drainage core surface.

2.3 SOIL MATERIALS

- A. Soil materials are specified in Section 280020 "Earth Moving."

2.4 WATERPROOFING FELTS

- A. Material: Comply with ASTM D 226, Type I, asphalt or ASTM D 227, coal-tar-saturated organic felt.

2.5 GEOTEXTILE FILTER FABRICS

- A. Description: Fabric of PP or polyester fibers or combination of both, with flow rate range from **110 to 330 gpm/sq. ft.** when tested according to ASTM D 4491.
- B. Structure Type: Nonwoven, needle-punched continuous filament.
 1. Survivability: AASHTO M 288 Class 2.
 2. Styles: Flat and sock.

PART 3 - EXECUTION

3.1 EXAMINATION

- A. Examine surfaces and areas for suitable conditions where subdrainage systems are to be installed.
- B. Verify that drainage panels installed as part of foundation wall waterproofing is properly positioned to drain into subdrainage system.
- C. Proceed with installation only after unsatisfactory conditions have been corrected.

3.2 EARTHWORK

- A. Excavating, trenching, and backfilling are specified in Section 280020 "Earth Moving."

3.3 FOUNDATION DRAINAGE INSTALLATION

- A. Place impervious fill material on subgrade adjacent to bottom of footing after concrete footing forms have been removed. Place and compact impervious fill to dimensions indicated, but not less than **6 inches** deep and **12 inches** wide.
- B. Lay flat-style geotextile filter fabric in trench and overlap trench sides.
- C. Place supporting layer of drainage course over compacted subgrade and geotextile filter fabric, to compacted depth of not less than **4 inches**.
- D. Encase pipe with sock-style geotextile filter fabric before installing pipe. Connect sock sections with adhesive or tape.
- E. Install drainage piping as indicated in Part 3 "Piping Installation" Article for foundation subdrainage.
- F. Add drainage course to width of at least **6 inches** on side away from wall and to top of pipe to perform tests.
- G. After satisfactory testing, cover drainage piping to width of at least **6 inches** on side away from footing and above top of pipe to within **12 inches** of finish grade.
- H. Install drainage course and wrap top of drainage course with flat-style geotextile filter fabric.
- I. Place layer of flat-style geotextile filter fabric over top of drainage course, overlapping edges at least **4 inches**.
- J. Install drainage panels on foundation walls as follows:
 - 1. Coordinate placement with other drainage materials.
 - 2. Lay perforated drainage pipe at base of footing. Install as indicated in Part 3 "Piping Installation" Article.
 - 3. Separate **4 inches** of fabric at beginning of roll and cut away **4 inches** of core. Wrap fabric around end of remaining core.
 - 4. Attach panels to wall beginning at subdrainage pipe. Place and secure molded-sheet drainage panels, with geotextile facing away from wall.
- K. Place backfill material over compacted drainage course. Place material in loose-depth layers not exceeding **6 inches**. Thoroughly compact each layer. Final backfill to finish elevations and slope away from building.

3.4 RETAINING-WALL DRAINAGE INSTALLATION

- A. Lay flat-style geotextile filter fabric in trench and overlap trench sides.
- B. Place supporting layer of drainage course over compacted subgrade to compacted depth of not less than **4 inches**.
- C. Encase pipe with sock-style geotextile filter fabric before installing pipe. Connect sock sections with adhesive or tape.

- D. Install drainage piping as indicated in Part 3 "Piping Installation" Article for retaining-wall subdrainage.
- E. Add drainage course to width of at least **6 inches** on side away from wall and to top of pipe to perform tests.
- F. After satisfactory testing, cover drainage piping to width of at least **6 inches** on side away from footing and above top of pipe to within **12 inches** of finish grade.
- G. Place drainage course in layers not exceeding **3 inches** in loose depth; compact each layer placed and wrap top of drainage course with flat-style geotextile filter fabric.
- H. Place layer of flat-style geotextile filter fabric over top of drainage course, overlapping edges at least **4 inches**.
- I. Install drainage panels on wall as follows:
 - 1. Coordinate placement with other drainage materials.
 - 2. Lay perforated drainage pipe at base of footing as described elsewhere in this Specification. Do not install aggregate.
 - 3. Mark horizontal chalk line on wall at a point **6 inches** less than panel width above footing bottom. Before marking wall, subtract footing width.
 - 4. Separate **4 inches** of fabric at beginning of roll and cut away **4 inches** of core. Wrap fabric around end of remaining core.
 - 5. Attach panel to wall at horizontal mark and at beginning of wall corner. Place core side of panel against wall. Use concrete nails with washers through product. Place nails from **2 to 6 inches** below top of panel, approximately **48 inches** apart. Construction adhesives, metal stick pins, or double-sided tape may be used instead of nails. Do not penetrate waterproofing. Before using adhesives, discuss with waterproofing manufacturer.
 - 6. If another panel is required on same row, cut away **4 inches** of installed panel core and wrap fabric over new panel.
 - 7. If additional rows of panel are required, overlap lower panel with **4 inches** of fabric.
 - 8. Cut panel as necessary to keep top **12 inches** below finish grade.
 - 9. For inside corners, bend panel. For outside corners, cut core to provide **3 inches** for overlap.
- J. Fill to Grade: Place satisfactory soil fill material over compacted drainage course. Place material in loose-depth layers not exceeding **6 inches**. Thoroughly compact each layer. Fill to finish grade.

3.5 PIPING INSTALLATION

- A. Install piping beginning at low points of system, true to grades and alignment indicated, with unbroken continuity of invert. Bed piping with full bearing in filtering material. Install gaskets, seals, sleeves, and couplings according to manufacturer's written instructions and other requirements indicated.
 - 1. Foundation Subdrainage: Install piping level on max 1/8 inch per foot slope and with a minimum cover of **36 inches** unless otherwise indicated.

2. Retaining-Wall Subdrainage: When water discharges at end of wall into stormwater piping system, install piping level on max 1/8 inch per foot slope and with a minimum cover of 36 inches unless otherwise indicated.
- B. Use increasers, reducers, and couplings made for different sizes or materials of pipes and fittings being connected. Reduction of pipe size in direction of flow is prohibited.
- C. Install thermoplastic piping according to ASTM D 2321.

3.6 PIPE JOINT CONSTRUCTION

- A. Join perforated PE pipe and fittings with couplings according to ASTM D 3212 with loose banded, coupled, or push-on joints.
- B. Join perforated PVC sewer pipe and fittings according to ASTM D 3212 with loose bell-and-spigot, push-on joints.
- C. Special Pipe Couplings: Join piping made of different materials and dimensions with special couplings made for this application. Use couplings that are compatible with and fit materials and dimensions of both pipes.

3.7 CLEANOUT INSTALLATION

- A. Comply with requirements for cleanouts specified in Section 286010 "Storm Utility Drainage Piping."
- B. Cleanouts for foundation and retaining-wall Subdrainage:
 1. Install cleanouts from piping to grade. Locate cleanouts at beginning of piping run and at changes in direction. Install fittings so cleanouts open in direction of flow in piping.
 2. In nonvehicular-traffic areas, use NPS 4 (DN 100) PVC pipe and fittings for piping branch fittings and riser extensions to cleanout. Set cleanout frames and covers in a cast-in-place concrete anchor, 12 by 12 by 4 inches deep. Set top of cleanout 2 inches above grade.
 3. Comply with requirements for concrete specified in Section 240020 "Cast-in-Place Concrete."

3.8 CONNECTIONS

- A. Comply with requirements for piping specified in Section 286010 "Storm Utility Drainage Piping." Drawings indicate general arrangement of piping, fittings, and specialties.
- B. Connect low elevations of subdrainage system to building's solid-wall-piping storm drainage system.

3.9 IDENTIFICATION

- A. Arrange for installation of green warning tapes directly over piping. Comply with requirements for underground warning tapes specified in specified in Section 280620 "Earth Moving."
 - 1. Install PE warning tape or detectable warning tape over ferrous piping.
 - 2. Install detectable warning tape over nonferrous piping and over edges of underground structures.

3.10 FIELD QUALITY CONTROL

- A. Tests and Inspections:
 - 1. After installing drainage course to top of piping, test drain piping with water to ensure free flow before backfilling.
 - 2. Remove obstructions, replace damaged components, and repeat test until results are satisfactory.
- B. Drain piping will be considered defective if it does not pass tests and inspections.
- C. Prepare test and inspection reports.

3.11 CLEANING

- A. Clear interior of installed piping and structures of dirt and other superfluous material as work progresses. Maintain swab or drag in piping and pull past each joint as it is completed. Place plugs in ends of uncompleted pipe at end of each day or when work stops.

** END OF SECTION **

**SECTION 300010
DEMONSTRATION AND TRAINING**

PART 1 - GENERAL

1.1 SUMMARY

- A. This Section includes administrative and procedural requirements for instructing Owner's personnel, including the following:
 - 1. Demonstration of operation of systems, subsystems, and equipment.
 - 2. Training in operation and maintenance of systems, subsystems, and equipment.

1.2 SUBMITTALS

- A. Instruction Program: Submit two copies of outline of instructional program for demonstration and training, including a schedule of proposed dates, times, length of instruction time, and instructors' names for each training module. Include learning objective and outline for each training module.
 - 1. At completion of training, submit two complete Training Manual for Owner's use.
- B. Qualification Data: For instructor.
- C. Attendance Record: For each training module, submit list of participants and length of instruction time.
- D. Evaluations: For each participant and for each training module, submit results and documentation of performance-based test.

1.3 QUALITY ASSURANCE

- A. Instructor Qualifications: A factory-authorized service representative, experienced in operation and maintenance procedures and training.

1.4 COORDINATION

- A. Coordinate instruction schedule with Owner's operations. Adjust schedule as required to minimize disrupting Owner's operations.
- B. Coordinate instructors, including providing notification of dates, times, length of instruction time, and course content.
- C. Coordinate content of training modules with content of approved emergency, operation, and maintenance manuals.

PART 2 - PRODUCTS

2.1 INSTRUCTION PROGRAM

- A. Program Structure: Develop an instruction program that includes individual training modules for each system and equipment not part of a system, as required by individual Specification Sections, and as follows:
1. Motorized doors, including overhead sectional doors.
 2. Equipment.
 3. HVAC systems.
 4. HVAC instrumentation and controls.
 5. Electrical service and distribution, including transformers, switchboards, panelboards, uninterruptible power supplies and motor controls.
 6. Lighting equipment and controls.
- B. Training Modules: Develop a learning objective and teaching outline for each module. Include a description of specific skills and knowledge that participant is expected to master. For each module, include instruction for the following:
1. Basis of System Design, Operational Requirements, and Criteria: Include the following:
 - a. System, subsystem, and equipment descriptions.
 - b. Performance and design criteria if Contractor is delegated design responsibility.
 - c. Operating standards.
 - d. Regulatory requirements.
 - e. Equipment function.
 - f. Operating characteristics.
 - g. Limiting conditions.
 - h. Performance curves.
 2. Documentation: Review the following items in detail:
 - a. Emergency manuals.
 - b. Operations manuals.
 - c. Maintenance manuals.
 - d. Project Record Documents.
 - e. Identification systems.
 - f. Warranties and bonds.
 - g. Maintenance service agreements and similar continuing commitments.
 3. Emergencies: Include the following, as applicable:
 - a. Instructions on meaning of warnings, trouble indications, and error messages.
 - b. Instructions on stopping.
 - c. Shutdown instructions for each type of emergency.
 - d. Operating instructions for conditions outside of normal operating limits.
 - e. Sequences for electric or electronic systems.
 - f. Special operating instructions and procedures.

4. Operations: Include the following, as applicable:
 - a. Startup procedures.
 - b. Equipment or system break-in procedures.
 - c. Routine and normal operating instructions.
 - d. Regulation and control procedures.
 - e. Control sequences.
 - f. Safety procedures.
 - g. Instructions on stopping.
 - h. Normal shutdown instructions.
 - i. Operating procedures for emergencies.
 - j. Operating procedures for system, subsystem, or equipment failure.
 - k. Seasonal and weekend operating instructions.
 - l. Required sequences for electric or electronic systems.
 - m. Special operating instructions and procedures.

5. Adjustments: Include the following:
 - a. Alignments.
 - b. Checking adjustments.
 - c. Noise and vibration adjustments.
 - d. Economy and efficiency adjustments.

6. Troubleshooting: Include the following:
 - a. Diagnostic instructions.
 - b. Test and inspection procedures.

7. Maintenance: Include the following:
 - a. Inspection procedures.
 - b. Types of cleaning agents to be used and methods of cleaning.
 - c. List of cleaning agents and methods of cleaning detrimental to product.
 - d. Procedures for routine cleaning
 - e. Procedures for preventive maintenance.
 - f. Procedures for routine maintenance.
 - g. Instruction on use of special tools.

8. Repairs: Include the following:
 - a. Diagnosis instructions.
 - b. Repair instructions.
 - c. Disassembly; component removal, repair, and replacement; and reassembly instructions.
 - d. Instructions for identifying parts and components.
 - e. Review of spare parts needed for operation and maintenance.

PART 3 - EXECUTION

3.1 PREPARATION

- A. Assemble educational materials necessary for instruction, including documentation and training module. Assemble training modules into a combined training manual.
- B. Set up instructional equipment at instruction location.

3.2 INSTRUCTION

- A. Engage qualified instructors to instruct Owner's personnel to adjust, operate, and maintain systems, subsystems, and equipment not part of a system.
- B. Scheduling: Provide instruction at mutually agreed on times. For equipment that requires seasonal operation, provide similar instruction at start of each season.
 1. Schedule training with Owner with at least seven days' advance notice.
- C. Evaluation: At conclusion of each training module, assess and document each participant's mastery of module by use of a demonstration performance-based test.
- D. Cleanup: Collect used and leftover educational materials and give to Owner. Remove instructional equipment. Restore systems and equipment to condition existing before initial training use.

** END OF SECTION **

SECTION 320010 GENERAL COMMISSIONING REQUIREMENTS

PART 1 - GENERAL

1.1 SUMMARY

- A. Section includes general requirements that apply to implementation of commissioning without regard to specific systems, assemblies, or components.

1.2 DEFINITIONS

- A. **BoD: Basis of Design.** A document that records concepts, calculations, decisions, and product selections used to meet the OPR and to satisfy applicable regulatory requirements, standards, and guidelines. The document includes both narrative descriptions and lists of individual items that support the design process.
- B. **Commissioning Plan:** A document that outlines the organization, schedule, allocation of resources, and documentation requirements of the commissioning process.
- C. **CxA: Commissioning Authority.**
- D. **OPR: Owner's Project Requirements.** A document that details the functional requirements of a project and the expectations of how it will be used and operated. These include Project goals, measurable performance criteria, cost considerations, benchmarks, success criteria, and supporting information.
- E. **Systems, Subsystems, Equipment, and Components:** Where these terms are used together or separately, they shall mean "as-built" systems, subsystems, equipment, and components.

1.3 COMMISSIONING TEAM

- A. **Members Appointed by Contractor(s):** Individuals, each having the authority to act on behalf of the entity he or she represents, explicitly organized to implement the commissioning process through coordinated action. The commissioning team shall consist of, but not be limited to, representatives of Contractor, including Project superintendent and subcontractors, installers, suppliers, and specialists deemed appropriate by the CxA.
- B. **Members Appointed by Owner:**
 - 1. **CxA:** The designated person, company, or entity that plans, schedules, and coordinates the commissioning team to implement the commissioning process. Owner will engage the CxA under a separate contract.
 - 2. Representatives of the facility user and operation and maintenance personnel.
 - 3. Architect and Engineering design professionals.

1.4 OWNER'S RESPONSIBILITIES

- A. Provide the OPR documentation to the CxA and Contractor for information and use.
- B. Assign operation and maintenance personnel and schedule them to participate in commissioning team activities.
- C. Provide the BoD documentation, prepared by the Design Team and approved by Owner, to the CxA and Contractor for use in developing the commissioning plan, systems manual, and operation and maintenance training plan.

1.5 CONTRACTOR'S RESPONSIBILITIES

- A. Contractor shall assign representatives with expertise and authority to act on its behalf and shall schedule them to participate in and perform commissioning process activities including, but not limited to, the following:
 - 1. Evaluate performance deficiencies identified in test reports and, in collaboration with entity responsible for system and equipment installation, recommend corrective action.
 - 2. Cooperate with the CxA for resolution of issues recorded in the Issues Log.
 - 3. Attend commissioning team meetings held on a monthly basis.
 - 4. Integrate and coordinate commissioning process activities with construction schedule.
 - 5. Review and accept construction checklists provided by the CxA.
 - 6. Complete paper construction checklists as Work is completed and provide to the Commissioning Authority on a weekly basis.
 - 7. Review and accept commissioning process test procedures provided by the Commissioning Authority.
 - 8. Complete commissioning process test procedures.

1.6 CxA'S RESPONSIBILITIES

- A. Organize and lead the commissioning team.
- B. Provide commissioning plan.
- C. Convene commissioning team meetings.
- D. Provide Project-specific construction checklists and commissioning process test procedures.
- E. Verify the execution of commissioning process activities using random sampling. The sampling rate may vary from 1 to 100 percent. Verification will include, but is not limited to, equipment submittals, construction checklists, training, operating and maintenance data, tests, and test reports to verify compliance with the OPR. When a random sample does not meet the requirement, the CxA will report the failure in the Issues Log.
- F. Prepare and maintain the Issues Log.
- G. Prepare and maintain completed construction checklist log.
- H. Witness systems, assemblies, equipment, and component startup.

- I. Compile test data, inspection reports, and certificates; include them in the systems manual and commissioning process report.

PART 2 - PRODUCTS (Not Used)

- A. EXECUTION (Not Used)

** END OF SECTION **

SECTION 340010 CLOSEOUT PROCEDURES

PART 1 - GENERAL

1.1 Summary

- A. This Section includes administrative and procedural requirements for contract closeout, including, but not limited to, the following:
 - 1. Inspection procedures.
 - 2. Project Record Documents.
 - 3. Operation and Maintenance Manuals.
 - 4. Warranties.
 - 5. Instructions of Owner's personnel.
 - 6. Final Cleaning.

1.2 Substantial Completion

- A. Preliminary Procedures: Before requesting inspection for determining date of Substantial Completion, complete the following. List items below that are incomplete in request.
 - 1. Prepare a list of items to be completed and corrected (punch list), the value of items on the list, and reasons why the Work is not complete.
 - 2. Advise Owner of pending insurance changeover requirements.
 - 3. Submit specific warranties, workmanship bonds, maintenance service agreements, final certifications, and similar documents.
 - 4. Obtain and submit releases permitting Owner unrestricted use of the Work and access to services and utilities. Include occupancy permits, operating certificates, and similar releases.
 - 5. Prepare and submit Project Record Documents, operation and maintenance manuals, Final Completion construction photographs, damage or settlement surveys, property surveys, and similar final record information.
 - 6. Deliver tools, spare parts, extra materials, and similar items to location designated by Owner. Label with Manufacturer's name and model number where applicable.
 - 7. Make final changeover of permanent locks and deliver keys to Owner. Advise Owner's personnel of changeover in security provisions.
 - 8. Complete startup testing of systems.
 - 9. Submit test/adjust/balance records.
 - 10. Terminate and remove temporary facilities from Project site, along with mockups, construction tools, and similar elements.
 - 11. Advise Owner of changeover in heat and other utilities.
 - 12. Submit changeover information related to Owner's occupancy, use, operation, and maintenance.
 - 13. Complete final cleaning requirements, including touchup painting.
 - 14. Touch up and otherwise repair and restore marred exposed finishes to eliminate visual defects.

- B. Inspection: Submit a written request for inspection for Substantial Completion. On receipt of request, Owner will either proceed with inspection or notify Contractor of unfulfilled requirements. Owner will prepare the Certificate of Substantial Completion after inspection or will notify Contractor of items, either on Contractor's list or additional items identified by Owner, that must be completed or corrected before certificate will be issued.
 - 1. Re-inspection: Request re-inspection when the Work identified in previous inspections as incomplete is completed or corrected.
 - 2. Results of completed inspection will form the basis of requirements for Final Completion.

1.3 Final Completion

- A. Preliminary Procedures: Before requesting final inspection for determining date of Final Completion, complete the following:
 - 1. Submit certified copy of Owner's Substantial Completion inspection list of items to be completed or corrected (punch list), endorsed and dated by Owner. The certified copy of the list shall state that each item has been completed or otherwise resolved for acceptance.
 - 2. Submit evidence of final, continuing insurance coverage complying with insurance requirement.
 - 3. Submit pest-control final inspection report and warranty.
 - 4. Instruct Owner's personnel in operation, adjustment, and maintenance of products, equipment, and systems.
- B. Inspection: Submit a written request for final inspection for acceptance. On receipt of request, Owner will either proceed with inspection or notify Contractor of unfulfilled requirements. Owner will prepare a final Certificate for Payment after inspection or will notify Contractor of construction that must be completed or corrected before certificate will be issued.
 - 1. Re-inspection: Request re-inspection when the Work identified in previous inspections as incomplete is completed or corrected.

1.4 List of Incomplete Items (Punch List)

- A. Preparation: Submit three (3) copies of list. List to include items from GC's Punch List Inspection as well as all items from Owner's Punch List Inspections. Include name and identification of each space and area affected by construction operations for incomplete items and items needing correction including, if necessary, areas disturbed by Contractor that are outside the limits of construction.
 - 1. Organize list of spaces in sequential order starting with exterior areas first and proceeding from lowest floor to highest floor.
 - 2. Organize items applying to each space by major element, including categories for ceiling, individual walls, floors, equipment, and building systems.
 - 3. Include the following information at the top of each page:

- a. Project name.
- b. Date.
- c. Name of Contractor.
- d. Page Number.

1.5 Project Record Documents

- A. General: Do not use Project Record Documents for construction purposes. Protect Project Record Documents from deterioration and loss. Provide access to Project Record Documents for Owner's reference during normal working hours.
- B. Record Drawings: Maintain and submit one set of black line white prints of Shop Drawings.
 1. Mark Record Prints to show the actual installation where installation varies from that shown originally. Require individual or entity who obtained record data, whether individual or entity is Installer, subcontractor, or similar entity, to prepare the marked-up Record Prints.
 - a. Give particular attention to information on concealed elements that cannot be readily identified and recorded later.
 - b. Accurately record information in an understandable drawing technique.
 - c. Record data as soon as possible after obtaining it. Record and check the markup before enclosing concealed installations.
 - d. Mark Shop Drawings, showing actual physical conditions, completely and accurately.
 2. Mark record sets with erasable, red-colored pencil. Use other colors to distinguish between changes for different categories of the Work at the same location.
 3. Mark important additional information that was either shown schematically or omitted from original Drawings.
 4. Note Construction Change Directive numbers, Change Order numbers, alternate numbers, and similar identification where applicable.
 5. Identify and date each Record Drawing; include the designation "PROJECT RECORD DRAWING" in a prominent location. Organize into manageable sets; bind each set with durable paper cover sheets. Include identification on cover sheets.
- C. Record Specifications: Submit one copy of Project's Specifications, including addenda and contract modifications. Mark copy to indicate the actual product installation where installation varies from that indicated in Specifications, addenda, and contract modifications.
 1. Give particular attention to information on concealed products and installations that cannot be readily identified and recorded later.
 2. Mark copy with the proprietary name and model number of products, materials, and equipment furnished, including substitutions and product options selected.

3. Note related Change Orders, Record Drawings and Product Data, where applicable.
- D. Record Product Data: Submit one copy of each Product Data submittal. Mark one set to indicate the actual product installation where installation varies substantially from that indicated in Product Data.
1. Give particular attention to information on concealed products and installations that cannot be readily identified and recorded later.
 2. Include significant changes in the product delivered to Project site and changes in Manufacturer's written instructions for installation.
 3. Note related Change Orders, Record Drawings where applicable.
- E. Miscellaneous Record Submittals: Assemble miscellaneous records required by other Specification Sections for miscellaneous record keeping and submittal in connection with actual performance of the Work. Bind or file miscellaneous records and identify each, ready for continued use and reference.

1.6 Operation and Maintenance Manuals

- A. Assemble a complete set of operation and maintenance data indicating the operation and maintenance of each system, subsystem, and piece of equipment not part of a system. Include operation and maintenance data required in individual Specification Sections and as follows:
1. Operation Data:
 - a. Emergency instructions and procedures.
 - b. System, subsystem, and equipment descriptions, including operating standards.
 - c. Operating procedures, including startup, shutdowns, seasonal, and weekend operations.
 - d. Description of controls and sequence of operations.
 - e. Piping diagrams.
 2. Maintenance Data:
 - a. Manufacturer's information, including list of spare parts.
 - b. Name, address, and telephone number of Installer or supplier.
 - c. Maintenance procedures.
 - d. Maintenance and services schedules for preventive and routine maintenance.
 - e. Maintenance record forms.
 - f. Sources of spare parts and maintenance materials.
 - g. Copies of maintenance service agreements.
 - h. Copies of warranties and bonds.
- B. Organize operation and maintenance manuals into suitable sets of manageable size. Bind and index data in heavy-duty, 3-ring, vinyl-covered, loose-leaf binders, in thickness necessary to accommodate contents, with pocket inside the covers to receive folded

oversized sheets. Identify each binder on front and spine with the printed title "OPERATION AND MAINTENANCE MANUAL," Project name, and subject matter of contents.

1.7 Warranties

- A. Submittal Time: Submit written warranties for designated portions of the Work where commencement of warranties other than date of Substantial Completion is indicated.
- B. Partial Occupancy: Submit properly executed warranties within fifteen (15) days of completion of designated portions of the Work that are completed and occupied or used by Owner during construction period by separate agreement with Contractor.
- C. Organize warranty documents into an orderly sequence based on the table of contents of the Project Manual.
 - 1. Bind warranties and bonds in heavy-duty, 3-ring, vinyl-covered, loose-leaf binders, thickness as necessary to accommodate contents, and sized to receive 8-1/2-by-11-inch paper.
 - 2. Provide heavy paper dividers with plastic-covered tabs for each separate warranty. Mark tab to identify the product or installation. Provide a typed description of the product or installation, including the name of the product and the name, address, and telephone number of Installer.
 - 3. Identify each binder on the front and spine with the typed or printed title "WARRANTIES," Project Name, and name of Contractor.
- D. Provide additional copies of each warranty to include in operation and Maintenance Manuals.

PART 2 - PRODUCTS

2.1 Materials

- A. Cleaning Agents: Use cleaning materials and agents recommended by Manufacturer or fabricator of the surface to be cleaned. Do not use cleaning agents that are potentially hazardous to health or property or that might damage finished surfaces.

PART 3 - EXECUTION

3.1 Demonstration and Training

- A. Instruction: Instruct Owner's personnel to adjust, operate, and maintain systems, subsystems, and equipment not part of a system.
 - 1. Provide instructors experienced in operation and maintenance procedures.
 - 2. Provide instruction at mutually agreed-on times. For equipment that requires seasonal operation, provide similar instruction at the start of each season.
 - 3. Schedule training with Owner with at least fourteen (14) days' advance notice.
 - 4. Coordinate instructors, including providing notification of dates, times, length of instruction, and course content.
- B. Program Structure: Develop an instruction program that includes individual training modules for each system and equipment not part of a system, as required by individual Specification Sections. For each training module, develop a learning objective and teaching outline. Include instruction for the following:
 - 1. System design and operational philosophy.
 - 2. Review of documentation.
 - 3. Operations.
 - 4. Adjustments.
 - 5. Troubleshooting.
 - 6. Maintenance.
 - 7. Repair.

3.2 Final Cleaning

- A. General: Provide final cleaning. Conduct cleaning and waste-removal operations to comply with local laws and ordinances and Federal and local environmental and antipollution regulations.
- B. Cleaning: Employ experienced workers or professional cleaners for final cleaning. Clean each surface or unit to condition expected in an average commercial building cleaning and maintenance program. Comply with Manufacturer's written instructions.
 - 1. Complete the following cleaning operations before requesting inspection for certification of Substantial Completion for entire Project or for a portion of Project:

- a. Clean Project site, yard, and grounds, in areas disturbed by construction activities, including landscape development areas, of rubbish, waste material, litter, and other foreign substances.
- b. Sweep paved areas broom clean. Remove petrochemical spills, stains, and other foreign deposits.
- c. Rake grounds that are neither planted nor paved to a smooth, even-textured surface.
- d. Remove tools, construction equipment, machinery, and surplus material from Project site.
- e. Remove snow and ice to provide safe access to building.
- f. Clean exposed exterior and interior hard-surfaced finishes to a dirt-free condition, free of stains, films, and similar foreign substances. Avoid disturbing natural weathering of exterior surfaces. Restore reflective surfaces to their original condition.
- g. Remove debris and surface dust from limited access spaces, including roofs, plenums, shafts, trenches, equipment vaults, manholes, attics, and similar spaces.
- h. Sweep concrete floors broom clean in unoccupied spaces.
- i. Clean transparent materials, including mirrors and glass in doors and windows. Remove glazing compounds and other noticeable, vision-obscuring materials. Replace chipped or broken glass and other damaged transparent materials. Polish mirrors and glass, taking care not to scratch surfaces.
- j. Remove labels that are not permanent.
- k. Touch up and otherwise repair and restore marred, exposed finishes and surfaces. Replace finishes and surfaces that cannot be satisfactorily repaired or restored or that already show evidence of repair or restoration.
 - 1) Do not paint over "UL" and similar labels, including mechanical and electrical nameplates.
- l. Wipe surfaces of mechanical and electrical equipment, and similar equipment. Remove excess lubrication, paint and mortar droppings, and other foreign substances.
- m. Replace parts subject to unusual operating conditions.
- n. Clean plumbing fixtures to a sanitary condition, free of stains, including stains resulting from water exposure.
- o. Replace disposable air filters and clean permanent air filters. Clean exposed surfaces of diffusers, registers, and grills.
- p. Clean ducts, blowers, and coils if units were operated without filters during construction.
- q. Clean light fixtures, lamps, globes, and reflectors to function with full efficiency. Replace burned-out bulbs, and those noticeably dimmed by hours of use, and defective and noisy starters in fluorescent and mercury vapor fixtures to comply with requirements for new fixtures.
- r. Leave Project clean and ready for occupancy.

- C. Comply with safety standards for cleaning. Do not burn waste materials. Do not bury debris or excess materials on Owner's property. Do not discharge volatile, harmful, or dangerous materials into drainage systems. Remove waste materials from Project site and dispose of lawfully.

** END OF SECTION **

**SECTION 340020
OPERATION AND MAINTENANCE DATA**

PART 1 - GENERAL

1.1 SUMMARY

- A. This Section includes administrative and procedural requirements for preparing operation and maintenance manuals, including the following:
 - 1. Operation and maintenance documentation directory.
 - 2. Emergency manuals.
 - 3. Operation manuals for systems, subsystems, and equipment.
 - 4. Maintenance manuals for the care and maintenance of products, materials, and finishes and systems and equipment.

1.2 DEFINITIONS

- A. System: An organized collection of parts, equipment, or subsystems united by regular interaction.
- B. Subsystem: A portion of a system with characteristics similar to a system.

1.3 SUBMITTALS

- A. Final Submittal: Submit two copies of each manual in final form at least 15 days before final inspection.

1.4 COORDINATION

- A. Where operation and maintenance documentation includes information on installations by more than one factory-authorized service representative, assemble and coordinate information furnished by representatives and prepare manuals.

PART 2 - PRODUCTS

2.1 OPERATION AND MAINTENANCE DOCUMENTATION DIRECTORY

- A. Organization: Include a section in the directory for each of the following:
 - 1. List of documents.
 - 2. List of systems.
 - 3. List of equipment.
 - 4. Table of contents.

- B. List of Systems and Subsystems: List systems alphabetically. Include references to operation and maintenance manuals that contain information about each system.
- C. List of Equipment: List equipment for each system, organized alphabetically by system. For pieces of equipment not part of system, list alphabetically in separate list.
- D. Tables of Contents: Include a table of contents for each emergency, operation, and maintenance manual.
- E. Identification: In the documentation directory and in each operation and maintenance manual, identify each system, subsystem, and piece of equipment with same designation used in the Contract Documents. If no designation exists, assign a designation according to ASHRAE Guideline 4, "Preparation of Operating and Maintenance Documentation for Building Systems."

2.2 MANUALS, GENERAL

- A. Organization: Unless otherwise indicated, organize each manual into a separate section for each system and subsystem, and a separate section for each piece of equipment not part of a system. Each manual shall contain the following materials, in the order listed:
 - 1. Title page.
 - 2. Table of contents.
 - 3. Manual contents.
- B. Title Page: Enclose title page in transparent plastic sleeve. Include the following information:
 - 1. Subject matter included in manual.
 - 2. Name and address of Project.
 - 3. Name and address of Owner.
 - 4. Date of submittal.
 - 5. Name, address, and telephone number of Contractor.
 - 6. Cross-reference to related systems in other operation and maintenance manuals.
- C. Table of Contents: List each product included in manual, identified by product name, indexed to the content of the volume, and cross-referenced to Specification Section number in Project Manual.
 - 1. If operation or maintenance documentation requires more than one volume to accommodate data, include comprehensive table of contents for all volumes in each volume of the set.
- D. Manual Contents: Organize into sets of manageable size. Arrange contents alphabetically by system, subsystem, and equipment. If possible, assemble instructions for subsystems, equipment, and components of one system into a single binder.
 - 1. Binders: Heavy-duty, 3-ring, vinyl-covered, loose-leaf binders, in thickness necessary to accommodate contents, sized to hold 8-1/2-by-11-inch paper; with clear plastic sleeve on spine to hold label describing contents and with pockets inside covers to hold folded oversize sheets.

- a. If two or more binders are necessary to accommodate data of a system, organize data in each binder into groupings by subsystem and related components. Cross-reference other binders if necessary to provide essential information for proper operation or maintenance of equipment or system.
 - b. Identify each binder on front and spine, with printed title "OPERATION AND MAINTENANCE MANUAL," Project title or name, and subject matter of contents. Indicate volume number for multiple-volume sets.
2. Dividers: Heavy-paper dividers with plastic-covered tabs for each section. Mark each tab to indicate contents. Include typed list of products and major components of equipment included in the section on each divider, cross-referenced to Specification Section number and title of Project Manual.
 3. Protective Plastic Sleeves: Transparent plastic sleeves designed to enclose diagnostic software diskettes for computerized electronic equipment.
 4. Supplementary Text: Prepared on 8-1/2-by-11-inch white bond paper.
 5. Drawings: Attach reinforced, punched binder tabs on drawings and bind with text.
 - a. If oversize drawings are necessary, fold drawings to same size as text pages and use as foldouts.
 - b. If drawings are too large to be used as foldouts, fold and place drawings in labeled envelopes and bind envelopes in rear of manual. At appropriate locations in manual, insert typewritten pages indicating drawing titles, descriptions of contents, and drawing locations.

2.3 EMERGENCY MANUALS

- A. Content: Organize manual into a separate section for each of the following:
 1. Type of emergency.
 2. Emergency instructions.
 3. Emergency procedures.
- B. Type of Emergency: Where applicable for each type of emergency indicated below, include instructions and procedures for each system, subsystem, piece of equipment, and component:
 1. Fire.
 2. Flood.
 3. Gas leak.
 4. Water leak.
 5. Power failure.
 6. Water outage.
 7. System, subsystem, or equipment failure.
- C. Emergency Instructions: Describe and explain warnings, trouble indications, error messages, and similar codes and signals. Include responsibilities of Owner's operating personnel for notification of Installer, supplier, and manufacturer to maintain warranties.
- D. Emergency Procedures: Include the following, as applicable:
 1. Instructions on stopping.

2. Shutdown instructions for each type of emergency.
3. Operating instructions for conditions outside normal operating limits.
4. Required sequences for electric or electronic systems.
5. Special operating instructions and procedures.

2.4 OPERATION MANUALS

- A. Content: In addition to requirements in this Section, include operation data required in individual Specification Sections and the following information:
1. System, subsystem, and equipment descriptions.
 2. Performance and design criteria if Contractor is delegated design responsibility.
 3. Operating standards.
 4. Operating procedures.
 5. Operating logs.
 6. Wiring diagrams.
 7. Control diagrams.
 8. Piped system diagrams.
 9. Precautions against improper use.
 10. License requirements including inspection and renewal dates.
- B. Descriptions: Include the following:
1. Product name and model number.
 2. Manufacturer's name.
 3. Equipment identification with serial number of each component.
 4. Equipment function.
 5. Operating characteristics.
 6. Limiting conditions.
 7. Performance curves.
 8. Engineering data and tests.
 9. Complete nomenclature and number of replacement parts.
- C. Operating Procedures: Include the following, as applicable:
1. Startup procedures.
 2. Equipment or system break-in procedures.
 3. Routine and normal operating instructions.
 4. Regulation and control procedures.
 5. Instructions on stopping.
 6. Normal shutdown instructions.
 7. Seasonal and weekend operating instructions.
 8. Required sequences for electric or electronic systems.
 9. Special operating instructions and procedures.
- D. Systems and Equipment Controls: Describe the sequence of operation, and diagram controls as installed.
- E. Piped Systems: Diagram piping as installed, and identify color-coding where required for identification.

2.5 PRODUCT MAINTENANCE MANUAL

- A. Content: Organize manual into a separate section for each product, material, and finish. Include source information, product information, maintenance procedures, repair materials and sources, and warranties and bonds, as described below.
- B. Source Information: List each product included in manual, identified by product name and arranged to match manual's table of contents. For each product, list name, address, and telephone number of Installer or supplier and maintenance service agent, and cross-reference Specification Section number and title in Project Manual.
- C. Product Information: Include the following, as applicable:
 - 1. Product name and model number.
 - 2. Manufacturer's name.
 - 3. Color, pattern, and texture.
 - 4. Material and chemical composition.
 - 5. Reordering information for specially manufactured products.
- D. Maintenance Procedures: Include manufacturer's written recommendations and the following:
 - 1. Inspection procedures.
 - 2. Types of cleaning agents to be used and methods of cleaning.
 - 3. List of cleaning agents and methods of cleaning detrimental to product.
 - 4. Schedule for routine cleaning and maintenance.
 - 5. Repair instructions.
- E. Repair Materials and Sources: Include lists of materials and local sources of materials and related services.
- F. Warranties and Bonds: Include copies of warranties and bonds and lists of circumstances and conditions that would affect validity of warranties or bonds.
 - 1. Include procedures to follow and required notifications for warranty claims.

2.6 SYSTEMS AND EQUIPMENT MAINTENANCE MANUAL

- A. Content: For each system, subsystem, and piece of equipment not part of a system, include source information, manufacturers' maintenance documentation, maintenance procedures, maintenance and service schedules, spare parts list and source information, maintenance service contracts, and warranty and bond information, as described below.
- B. Source Information: List each system, subsystem, and piece of equipment included in manual, identified by product name and arranged to match manual's table of contents. For each product, list name, address, and telephone number of Installer or supplier and maintenance service agent, and cross reference Specification Section number and title in Project Manual.
- C. Manufacturers' Maintenance Documentation: Manufacturers' maintenance documentation including the following information for each component part or piece of equipment:

1. Standard printed maintenance instructions and bulletins.
 2. Drawings, diagrams, and instructions required for maintenance, including disassembly and component removal, replacement, and assembly.
 3. Identification and nomenclature of parts and components.
 4. List of items recommended to be stocked as spare parts.
- D. Maintenance Procedures: Include the following information and items that detail essential maintenance procedures:
1. Test and inspection instructions.
 2. Troubleshooting guide.
 3. Precautions against improper maintenance.
 4. Disassembly; component removal, repair, and replacement; and reassembly instructions.
 5. Aligning, adjusting, and checking instructions.
 6. Demonstration and training videotape, if available.
- E. Maintenance and Service Schedules: Include service and lubrication requirements, list of required lubricants for equipment, and separate schedules for preventive and routine maintenance and service with standard time allotment.
1. Scheduled Maintenance and Service: Tabulate actions for daily, weekly, monthly, quarterly, semiannual, and annual frequencies.
 2. Maintenance and Service Record: Include manufacturers' forms for recording maintenance.
- F. Spare Parts List and Source Information: Include lists of replacement and repair parts, with parts identified and cross-referenced to manufacturers' maintenance documentation and local sources of maintenance materials and related services.
- G. Maintenance Service Contracts: Include copies of maintenance agreements with name and telephone number of service agent.
- H. Warranties and Bonds: Include copies of warranties and bonds and lists of circumstances and conditions that would affect validity of warranties or bonds.
1. Include procedures to follow and required notifications for warranty claims.

PART 3 - EXECUTION

3.1 MANUAL PREPARATION

- A. Operation and Maintenance Documentation Directory: Prepare a separate manual that provides an organized reference to emergency, operation, and maintenance manuals.
- B. Emergency Manual: Assemble a complete set of emergency information indicating procedures for use by emergency personnel and by Owner's operating personnel for types of emergencies indicated.

- C. Product Maintenance Manual: Assemble a complete set of maintenance data indicating care and maintenance of each product, material, and finish incorporated into the Work.
- D. Operation and Maintenance Manuals: Assemble a complete set of operation and maintenance data indicating operation and maintenance of each system, subsystem, and piece of equipment not part of a system.
 - 1. Engage a factory-authorized service representative to assemble and prepare information for each system, subsystem, and piece of equipment not part of a system.
 - 2. Prepare a separate manual for each system and subsystem, in the form of an instructional manual for use by Owner's operating personnel.
- E. Manufacturers' Data: Where manuals contain manufacturers' standard printed data, include only sheets pertinent to product or component installed. Mark each sheet to identify each product or component incorporated into the Work. Identify data applicable to the Work and delete references to information not applicable.
 - 1. Prepare supplementary text if manufacturers' standard printed data are not available and where the information is necessary for proper operation and maintenance of equipment or systems.
- F. Drawings: Prepare drawings supplementing manufacturers' printed data to illustrate the relationship of component parts of equipment and systems and to illustrate control sequence and flow diagrams. Coordinate these drawings with information contained in Record Drawings to ensure correct illustration of completed installation.
 - 1. Do not use original Project Record Documents as part of operation and maintenance manuals.

** END OF SECTION **

**SECTION 340030
SPARE PARTS AND MATERIALS**

PART 1 - GENERAL

1.1 SUMMARY

- A. This Section includes:
 - 1. Spare parts and materials.
- B. Related Sections include the following:
 - 1. Refer to individual sections for items listed herein, as well as other requirements.

PART 2 - PRODUCTS

2.1 EXTRA MATERIALS - GENERAL

- A. At the time of building acceptance, deliver to the Owner the following extra materials unless noted otherwise. Deliver in original unopened cartons or containers (except paint) with each item properly identified.

2.2 SEALANT (Section 241080)

- A. Furnish extra sealant materials from same production run as the materials applied in the quantities described below. Package materials in unopened, factory-sealed containers with labels describing contents.
 - 1. Quantity: Furnish one unused tube of each type and color of exterior sealant applied.

2.3 ACOUSTIC PANEL CEILINGS (Section 243010)

- A. Replacement stock amounting to one full box (minimum 12 tiles) of each type of ceiling tiles.

2.4 RESILIENT BASE (Section 242010)

- A. Furnish extra materials matching products installed as described below, packaged with protective covering for storage and identified with labels clearly describing contents.
 - 1. Furnish not less than 5% of each type and color of resilient base installed.

2.5 RESINOUS FLOORING (Section 242020)

- A. Furnish extra materials described below before installation begins that match products installed and that are packaged with protective covering for storage and identified with labels describing contents.
 - 1. One gallon minimum of each type and color of resinous flooring material.

2.6 TILE CARPETING (Section 242030)

- A. Furnish extra materials described below before installation begins that match products installed and that are packaged with protective covering for storage and identified with labels describing contents.
 - 1. Furnish not less than 5% of each type and color of carpet tile installed.

2.7 PAINT AND SPECIAL COATINGS (Sections 24)

- A. Furnish extra paint materials from the same production run as the materials applied in the quantities described below. Package paint materials in unopened, factory-sealed containers for storage.
 - 1. Quantity: Furnish the Owner with two gallons of each material and color applied in addition to any leftover amounts.

2.8 INTERIOR LIGHTING (Section 18)

- A. Furnish extra materials described below as applicable that match products installed and that are packaged with protective covering for storage and identified with labels describing contents:
 - 1. Lamps: Five of each rating installed.

PART 3 - EXECUTION (Not Applicable)

** END OF SECTION **